



BATHROOM
COLLECTIONS

CATALOGO
LISTINO

33

PER NOI IL BAGNO
È LA STANZA DEL BENESSERE
E IL BENESSERE NON CAPITA,
SI CREA.



AZIENDA, PRODUTTORI.

Produciamo accessori da bagno e soluzioni d'arredo dal 1978. Sono prodotti artigianali, i nostri, che nascono dai progetti di designers affermati, dalle nostre idee e dall'esperienza dei nostri collaboratori che da anni forgiavano ottone, acciaio, vetro e ceramica con mani esperte e passione costante. Questi prodotti, piace chiamarli "necessari per il bagno" perché, con le loro funzioni essenziali e insostituibili, garantiscono la qualità del benessere nella stanza da bagno. Lo specchio, l'illuminazione, l'oggettistica e tutti gli accessori, dal porta scopino al porta rotolo, dalla mensola al

porta asciugamani, dall'appendiabiti ai porta saponi, arredano e firmano lo stile del bagno. Con una gamma di oltre 2000 prodotti, proponiamo agli operatori del settore soluzioni funzionali e collaborazione progettuale per valorizzare e soddisfare le esigenze del cliente. Manteniamo il prestigio del Made in Italy, grazie alla creatività e alle capacità individuali connesse ad un indotto di aziende italiane affidabili e consolidate. Noi riteniamo il bagno è la stanza del benessere, e il benessere non capita, si crea.



NECESSARI PER IL BAGNO i motivi per collaborare con noi:

- Siamo produttori e realizziamo nel nostro stabilimento le proposte standard e personalizzate
- Siamo attenti alle nuove finiture per coordinarci alle rubinetterie.
- Siamo una squadra di professionisti della produzione artigianale, del marketing e dell'amministrazione
- Siamo rapidi nella realizzazione e nelle consegne
- Siamo a disposizione per consulenze tecniche e soluzioni razionali
- Siamo in grado di garantire i nostri prodotti per 5 anni
- Siamo disponibili ad ogni chiarimento sulla consultazione del nostro catalogo e del configuratore on line

In nostro catalogo vuole essere un utile strumento di vendita esprimendo concretezza ed efficienza aziendale.



THE FACTORY / L'ENTERPRISE DAS UNTERNEHMEN / ЧТО КОМПАНИЯ

We have been manufacturing bathroom accessories and furnishing solutions since 1978. Our products are handmade which are born from the projects of established designers, from our ideas and from the experience of our collaborators who have been molding brass, steel, glass and ceramic for years. We call our products "necessary for the bathroom" because, with their essential and irreplaceable functions, they guarantee the quality of well-being in the bathroom. The mirror, the lighting, the items and all the accessories like the toilet brush holder, the toilet roll holder, the shelf, the towel rack or soap holders, make the style of the bathroom. With a range of over 2000 products, we offer functional solutions and design to operators in the sector to satisfy customer needs. We maintain the prestige of Made in Italy, thanks to the creativity and individual skills connected to a supply chain of reliable and consolidated Italian companies. We believe the bathroom is the wellness room, and wellness does not happen, it is created.

The reasons to collaborate with us:

- We are producers and brass manufacturers. IN our factory we can customize on the single customer needs.
- We are attentive to the new finishes to coordinate with the faucets.
- We are a team of professional artisans, marketing and administration managers.
- We are quick to manufacture and deliver.
- We are available for technical customer service.
- We are able to guarantee our products for 5 years
- We are available to any clarification on consulting our catalog and online configurator. Our catalog is a useful sales tool, expressing business concreteness and efficiency.

Nous fabriquons des accessoires de salle de bain et des solutions d'ameublement depuis 1978. Nos produits sont faits à la main qui naissent des projets de designers établis, de nos idées et de l'expérience de nos collaborateurs qui moulent le laiton, l'acier, le verre et la céramique depuis des années. Nous appelons nos produits "nécessaires à la salle de bain" car, avec leurs fonctions essentielles et irremplaçables, ils garantissent la qualité du bien-être dans la salle de bain. Le miroir, l'éclairage, les articles et tous les accessoires comme le porte-brosse à WC, le porte-rouleau de papier toilette, l'étagère, le porte-serviettes ou les porte-savons, font le style de la salle de bain. Avec une gamme de plus de 2000 produits, nous proposons des solutions fonctionnelles et design aux opérateurs du secteur pour satisfaire les besoins des clients. Nous maintenons le prestige du Made in Italy, grâce à la créativité et aux compétences individuelles liées à une chaîne d'approvisionnement d'entreprises italiennes fiables et consolidées. Nous pensons que la salle de bain est la salle de bien-être et que le bien-être ne se produit pas, il est créé.

Les raisons de collaborer avec nous:

- Nous sommes producteurs et fabricants de laiton. Dans notre usine, nous pouvons personnaliser les besoins du client unique.
- Nous sommes attentifs aux nouvelles finitions pour les coordonner avec les robinets.
- Nous sommes une équipe d'artisans professionnels, de responsables marketing et administratifs.
- Nous fabriquons et livrons rapidement.
- Nous sommes disponibles pour le service client technique.
- Nous sommes en mesure de garantir nos produits pendant 5 ans
- Nous sommes disponibles pour toute clarification sur la consultation de notre catalogue et configurateur en ligne

Notre catalogue est un outil de vente utile, exprimant le concret et l'efficacité de l'entreprise.

Seit 1978 stellen wir Badzubehör und Einrichtungslösungen her. Unsere Produkte sind handgefertigt und stammen aus den Projekten etablierter Designer, aus unseren Ideen und aus der Erfahrung unserer Mitarbeiter, die seit Jahren Messing, Stahl, Glas und Keramik formen. Wir nennen unsere Produkte "notwendig für das Badezimmer", weil sie mit ihren wesentlichen und unersetzlichen Funktionen die Qualität des Wohlbefindens im Badezimmer garantieren. Der Spiegel, die Beleuchtung, die Gegenstände und das gesamte Zubehör wie der Toilettenbürstenhalter, der Toilettenpapierhalter, das Regal, der Handtuchhalter oder die Seifenhalter machen den Stil des Badezimmers aus. Mit einer Reihe von über 2000 Produkten bieten wir Betreibern in der Branche funktionale Lösungen und Design, um die Kundenbedürfnisse zu befriedigen. Dank der Kreativität und der individuellen Fähigkeiten, die mit einer Lieferkette zuverlässiger und konsolidierter italienischer Unternehmen verbunden sind, behalten wir das Prestige von Made in Italy bei. Wir glauben, dass das Badezimmer der Wellnessraum ist und Wellness nicht stattfindet, sondern geschaffen wird. Die Gründe für eine Zusammenarbeit mit uns:

- Wir sind Hersteller und Messinghersteller. In unserer Fabrik können wir auf die individuellen Kundenbedürfnisse anpassen.
- Wir sind aufmerksam auf die neuen Ausführungen, um uns mit den Wasserhähnen abzustimmen.
- Wir sind ein Team von professionellen Handwerkern, Marketing- und Verwaltungsmanagern.
- Wir produzieren und liefern schnell.
- Wir stehen für den technischen Kundendienst zur Verfügung.
- Wir können auf unsere Produkte 5 Jahre garantieren
- Für weitere Informationen zur Konsultation unseres Katalogs und Online-Konfigurators stehen wir Ihnen zur Verfügung

Unser Katalog ist ein nützliches Verkaufstool, das Geschäftskonkretheit und Effizienz zum Ausdruck bringt.

Мы производим аксессуары для ванных комнат и решения для мебели с 1978 года. Наши изделия изготавливаются вручную и являются результатом проектов известных дизайнеров, наших идей и опыта наших сотрудников, которые годами занимались литьем латуни, стали, стекла и керамики. Мы называем наши продукты «необходимыми для ванной комнаты», потому что, благодаря своим незаменимым и незаменимым функциям, они гарантируют качество ванной комнаты. Зеркало, освещение, предметы и все аксессуары, такие как держатель для туалетной щетки, держатель для туалетной бумаги, полка, вешалка для полотенца или мыльницы, определяют стиль ванной комнаты. С ассортиментом из более чем 2000 продуктов, мы предлагаем функциональные решения и дизайн для операторов в этом секторе, чтобы удовлетворить потребности клиентов. Мы сохраняем престиж Made in Italy благодаря креативности и индивидуальным навыкам, связанным с цепочкой поставок надежных и консолидированных итальянских компаний. Мы считаем, что ванная комната - это велнес-комната, и хорошего самочувствия не бывает, оно создано.

Причины работать с нами:

- Мы латунные производители и производители. На нашем заводе мы можем настроить индивидуальные потребности клиентов.
- Мы внимательно следим за новой отделкой, чтобы согласовать ее со смесителями.
- Мы команда профессиональных мастеров, менеджеров по маркетингу и администрации.
- Мы производим и доставляем быстро.
- Мы доступны для обслуживания клиентов.
- Мы можем гарантировать нашу продукцию в течение 5 лет
- Мы доступны для любых разъяснений, обратившись к нашему онлайн-каталогу и конфигуратору

Наш каталог является полезным инструментом продаж, который выражает специфику и эффективность компании.

DESIGNERS OF COLLECTIONS



STILHAUS

DIANA, GEA, MEDEA,
MIZAR, SATURNO, URANIA,
ELITE, GIUNONE, IDRA,
MARTE, NEMI, PRISMA,
REGAL, SMART, SMART LIGHT



CLAUDIO PAPA
ZEFIRO, QUID



MARKUS BINZ
RACK



MASSIMILIANO SETTIMELLI
ARIA, DIVA, LUI & LEI,
TOTEM, LIZ



GIANLUCA PALUDI
HASHI, ECO, DORIAN,
STEP-BOX, EQUILIBRIUM



PAOLO GALLETTI E DANIELE MALTINTI
KREA



GIOVANNA TALOCCI E MARCO PALLOCCA
RAIL, FOLD, BUCKET



BGR INDUSTRIAL DESIGN
LIVING



CERTIFICAZIONI E GARANZIA

I nostri prodotti sono realizzati con materiali di prima qualità e produzione italiana e sono sottoposti a trattamenti che ne garantiscono la resistenza alla corrosione e la durata nel tempo.

Un accurato controllo e verifica dell'assemblaggio, forte della nostra lunga esperienza, permettono di dare a questi prodotti una garanzia di 5 anni dalla data di acquisto, comprovata da un documento fiscale rilasciato dal negoziante.

Sono esclusi tutti i difetti derivanti da uso ed installazione impropri, errati o successivi interventi sul prodotto non autorizzati.

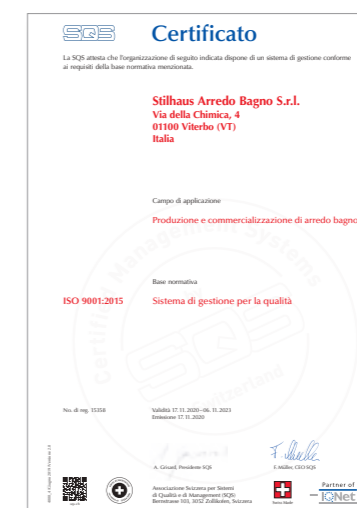

CERTIFICATIONS AND GUARANTEE CERTIFICATIONS ET GARANTIE ZERTIFIZIERUNGEN UND GARANTIEBESTIMMUNGEN СЕРТИФИКАЦИЯ И ГАРАНТИЯ

Our products are created using materials of the highest quality made in Italy. They undergo treatments which guarantee their resistance to corrosion and their durability. Our products undergo rigorous controls and tests during production enabling us to guarantee our products for 5 years from the date of purchase. This guarantee will be validated by a receipt or proof of purchase. The guarantee does not cover any damage due to incorrect installation or any other work carried out by unauthorised persons.

Nos produits sont réalisés avec des matériaux de première qualité et production Italienne et sont soumis à des traitements qui garantissent la résistance à la corrosion et la durabilité dans le temps. Un contrôle particulièrement soigné lors de l'assemblage et nos trente ans d'expérience nous permettent de donner à nos produits 5 ans de garantie à partir de la date d'achat qui est prouvée par un document (ticket de caisse ect) livré par le marchand. Sont exclus tous les défauts dérivant d'une mauvaise utilisation ou installation du produit ou dérivant de successives interventions non autorisées sur le produit.

Unsere Produkte wurden ausschließlich aus erstklassigen Materialien in Italien hergestellt und speziellen Verfahren unterzogen, die Dauerhaftigkeit und Widerstandsfähigkeit garantieren. Die genaue Kontrolle und Überprüfung der Produktion ist die Stärke in unserer 30-jährigen Erfahrung, die uns erlauben auf unsere Produkte 5 Jahre Garantie ab Kaufdatum (Rechnungsbeleg) zu gewähren. Ausgenommen sind Mängel die durch falsche Nutzung, fehlerhaften Einbau oder nachträgliche, nicht autorisierte Veränderungen am Produkt entstehen.

Наша продукция изготавливается из качественных материалов и подвергается различным обработкам, которые обеспечивают коррозионную стойкость и долговечность изделия. Тщательный контроль качества и сборка, многолетний опыт сотрудников, позволяют дать гарантию на продукцию 5 лет с даты покупки, о чем свидетельствует документ выданный для розничной торговли. Все дефекты, возникшие в результате неправильного использования или установки не рассматриваются.

DESIGN COLLECTION

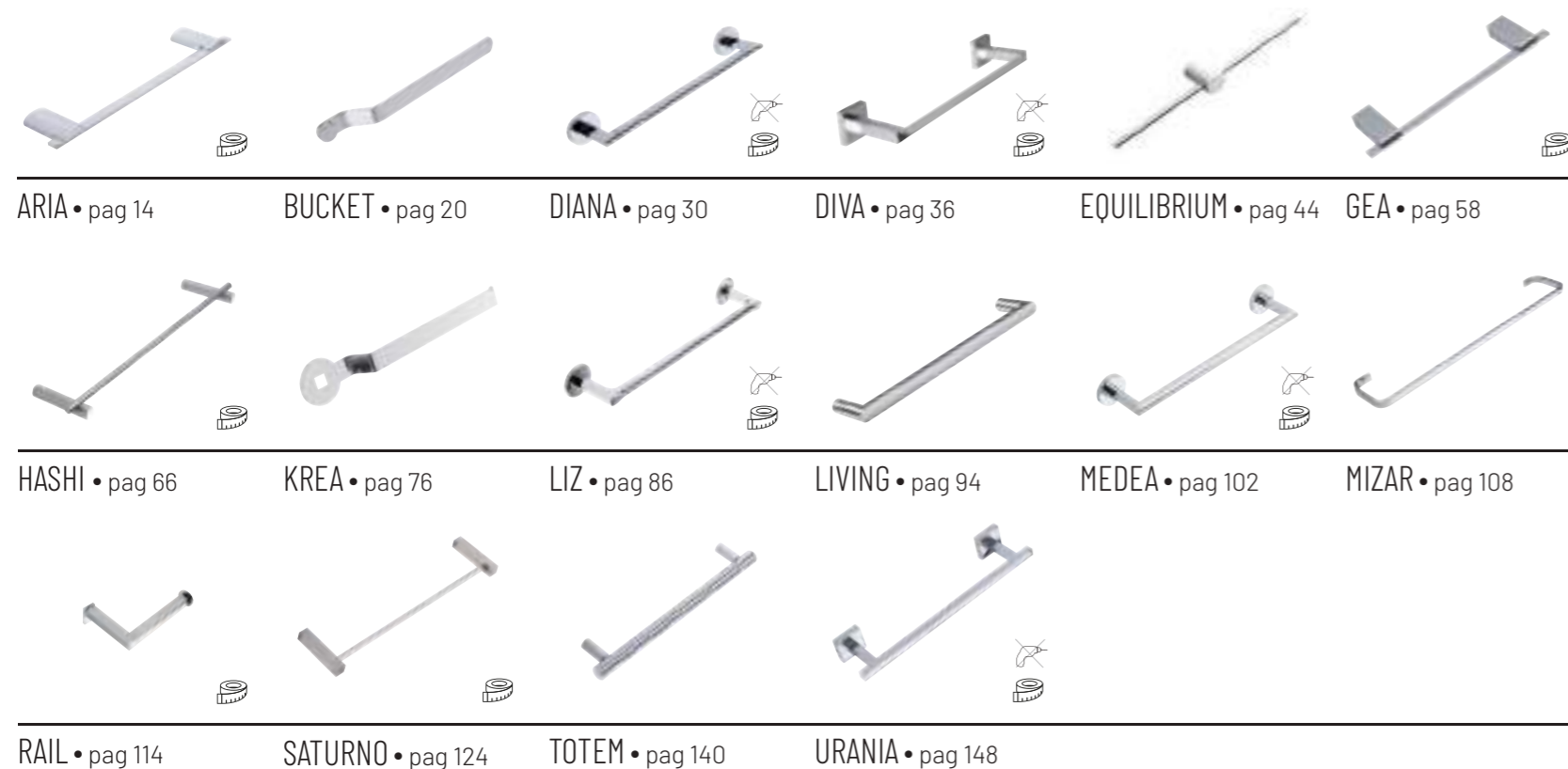

CLASSIC COLLECTION



STILHAUS COLLECTION



pag 6 **Designers**
Designers / Designers / Designers / дизайнеры

pag 450 **Ricambi**
Spare parts / Pièces de rechange / Ersatzteile / запчасти

pag 456 **Espositori**
Exhibitors / Exposants / Ausstellungsstände / Экспозиторы

pag 458 **Condizioni di vendita**
Terms of sale / Conditions de vente / Verkaufsbedingungen / условия продажи

pag 460 **Tabella colori**
Spare parts / Pièces de rechange / Ersatzteile / Таблица цветов

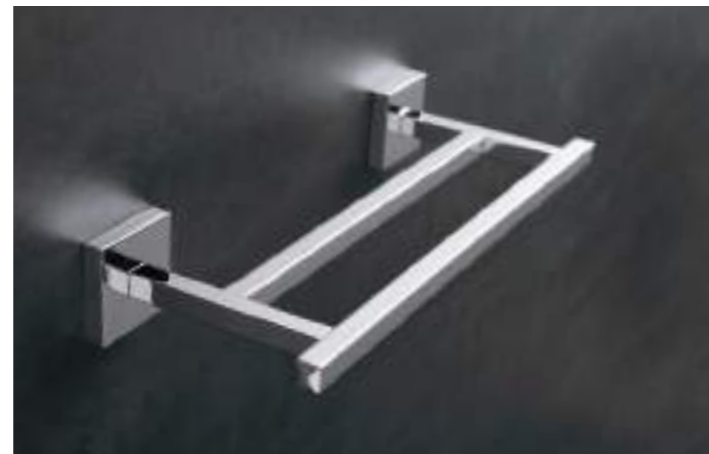
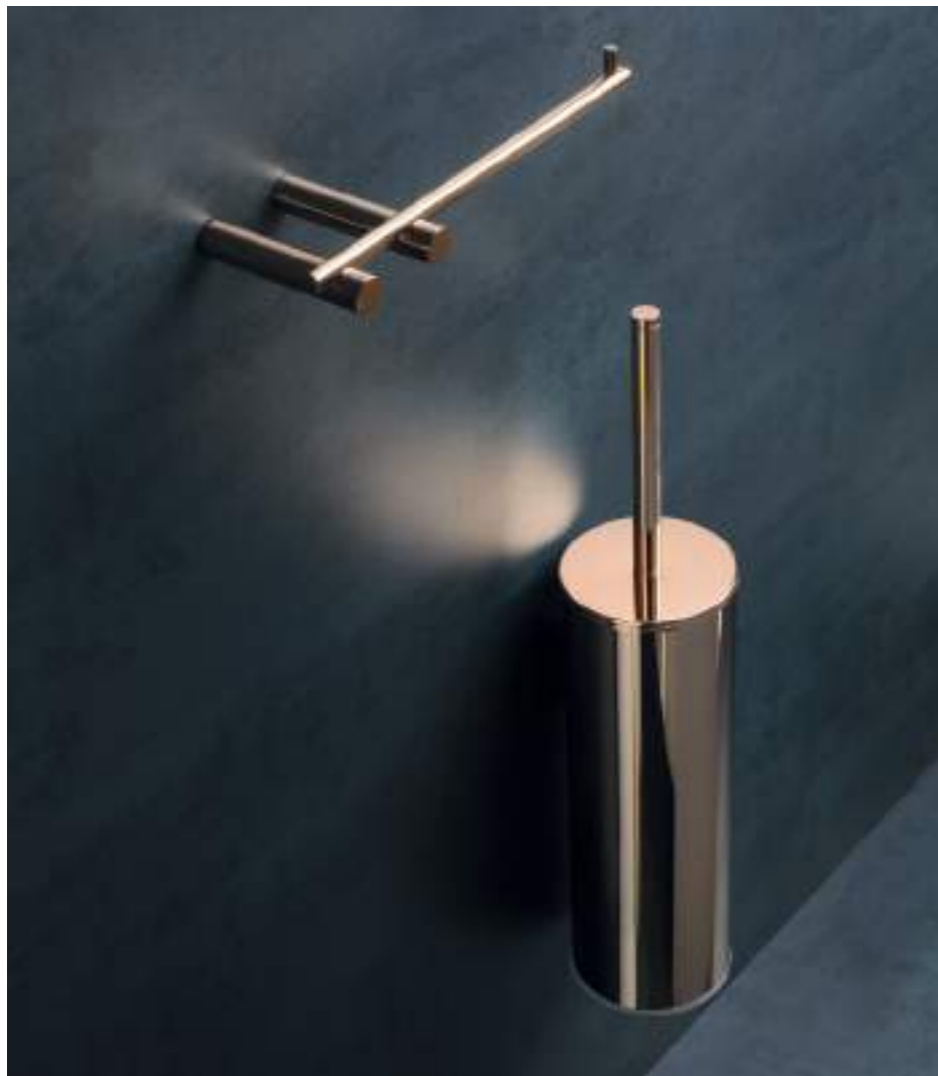

PROGETTO SARTORIA

TAILORING PROJECT / PROJET D'ADAPTATION

PROJEKT SCHNEIDEREI / ПРОЕКТ ПО ПОШИВУ ОДЕЖДЫ

Su queste linee si possono realizzare finiture abbinabili ai migliori marchi di rubinetti sul mercato.

- Aumento 50 % dal prezzo di listino del cromo
- Tempo di consegna: 20 gg lavorativi

On these lines we can match the finishes with the best taps brands on the market.

- Increase +50% on chrome finish price list.
- Production time: 20 work days

Ces lignes permettent de créer des finitions qui peuvent être combinées avec les meilleures marques de robinetterie du marché.

- 50 % de réduction sur le prix catalogue du chrome
- Délai de livraison : 20 jours ouvrables

Mit diesen Linien lassen sich Oberflächen gestalten, die mit den besten Armaturenmarken auf dem Markt kombiniert werden können.

- 50 % Rabatt auf den Listenpreis von
- ChromLieferzeit: 20 Arbeitstage

Эти линии можно использовать для создания отделки, которую можно сочетать с лучшими марками смесителей на рынке.

- со скидкой 50 % от прейскурантной цены хрома
- Срок поставки: 20 рабочих дней



FINITURE MONOCROMATICHE

MONOCHROME FINISHES / FINITIONS MONOCHROME

MONOCHROME OBERFLÄCHEN / МОНОХРОМНАЯ ОТДЕЛКА

- 08** Cromo_ Finitura galvanica
Chrome_ Galvanic finish
Chrome_ Finition galvanique
Chrom_ Galvanische Behandlung
Хром_ Гальваническая отделка
- 09** Ottone naturale_ Ottone spazzolato senza vernice soggetto a Rapido cambiamento ed ossidazione
Natural Brass_ Brushed brass. No painted. Subject to oxidation and slight darkening over time
Laiton naturel_ Laiton brossé sans peinture sujet à des changements rapides et à l'oxydation
Naturbelassenes Messing_ Gebürstetes Messing ohne Farbe, das einer schnellen Veränderung und Oxidation unterliegt
Натуральная латунь_ Матовая латунь без краски, подверженная быстрым изменениям и окислению
- 10** Ottone naturale verniciato lucido_ Ottone lucidato protetto da vernice trasparente lucida
Natural painted brass _ Polish brass, painted with transparent and protective shiny paint
Laiton naturel poli_ Laiton poli protégé par un vernis transparent brillant
Poliertes Messing Natur_ Poliertes Messing geschützt durch transparenten Glanzlack
Полированная натуральная латунь_ полированная латунь, защищенная прозрачным глянцевым лаком
- 12** Nickel lucido verniciato lucido_ Finitura galvanica protetta da vernice trasparente lucida
Polish nickel _Galvanic finish protected by transparent shiny paint
Peinture nickel poli_ Finition galvanique protégée par une peinture transparente brillante
Poliertes Nickel lackiert_ Galvanisches Finish durch glänzenden Klarlack geschützt
Полированный никель, окрашенный_ Гальваническая отделка, защищенная глянцевым прозрачным лаком
- 14** Oro chiaro champagne opaco_ Finitura galvanica di doratura con concentrazione ridotta e verniciatura trasparente opaca
Champagne matt gold_ Galvanic finish light gold concentration, painted with matt transparent paint
Or clair champagne mat_ Dorure à concentration réduite et vernis mat transparent
Mattes Champagner_ Hellgold_ Vergoldung mit reduzierter Konzentration und transparenter Mattlackierung
Матовое шампанское светлое золото_ Позолота с пониженной концентрацией и прозрачное матовое лакирование
- 15** Oro Satinato_ Finitura galvanica di doratura 24k, con spazzolatura manuale e verniciatura trasparente lucida
Satin gold_ Galvanic finish_ 24 k gold, handmade brushed effect, protected by transparent matt paint
Or satiné_ placage or galvanique 24k, avec brossage manuel et vernis transparent brillant.
Satiniertes Gold_ 24k galvanische Vergoldung, mit manueller Bürstung und transparenter Glanzlackierung
Сатиновое золото_ 24k гальваническое золотое покрытие, с ручным брашированием и прозрачным глянцевым лаком
- 16** Oro Lucido_ Finitura galvanica di doratura 24k protetta da verniciatura trasparente Lucida
Gold_ Galvanic gold 24k, protected by transparent paint
Or_ placage or galvanique 24k protégé par un vernis transparent
Gold_ F 24k galvanische Vergoldung geschützt durch transparenten
Gold_ F 24-каратное гальваническое золотое покрытие, защищенное прозрачным лаком
- 17** Oro Rosa_ Finitura galvanica di doratura in tonalità rosa, protetta da verniciatura trasparente lucida
Pink gold_ Galvanic finish Rose tone protected by transparent shiny paint
Pink Gold_ Finition dorée dans la nuance rose, protégée par un vernis transparent brillant.
Roségold_ Vergoldete Oberfläche in Rosatönen, geschützt durch transparenten, glänzenden Lack
Розовое золото_ Позолоченное покрытие розового оттенка, защищенное прозрачным глянцевым лаком
- 18** Oro Opaco_ Finitura galvanica di doratura 24k protetta da verniciatura trasparente Opaca
Matt gold_ Galvanic gold 24k, protected by transparent matt paint
Or opaco_ placage or galvanique 24k protégé par un vernis opaque transparent
Опак Gold_ F 24k galvanische Vergoldung geschützt durch transparenten Mattlack
Опакое Gold_ F 24-каратное гальваническое золотое покрытие, защищенное прозрачным лаком Opaco

- 19** Oro Inglese_ Finitura galvanica di doratura con concentrazione ridotta e verniciatura trasparente lucida
English gold _ Galvanic finish. low concentration of gold, protected by transparent shiny paint
Or anglais_ Finition galvanique en or avec concentration réduite et vernis transparent brillant
Englisches Gold_ Galvanische Vergoldung mit reduzierter Konzentration und transparenter Glanzlackierung
Английское золото_ Гальваническое золотое покрытие с пониженной концентрацией и прозрачным глянцевым лаком
- 23** Nero Opaco_ Verniciatura polvere elettrostatica cotta al forno 180°
Matt black _Electrostatic powder coating. baking paint 180°
Noir mat_ Poudrage électrostatique, cuit au four à 180°
Schwarz Matt_ Elektrostatische Pulverbeschichtung, 180° eingebrannt.
Черный матовый_ Электростатическое порошковое покрытие, запекается под углом 180°
- 24** Bianco Opaco_ Verniciatura polvere elettrostatica cotta al forno 180°
Matt white _Electrostatic powder coating. baking paint 180°
Blanc mat_ Poudrage électrostatique cuit au four à 180°
Weiß Matt_ Elektrostatische Pulverbeschichtung, 180° eingebrannt.
Белый матовый_ Электростатическое порошковое покрытие, запекаемое под углом 180°.
- 25** Bronzo_ Finitura galvanica di bronzatura con spazzolatura manuale e verniciatura trasparente lucida
Bronze_ Galvanic finish. handmade brushed. protected by transparent shiny paint
Bronze_ Finition bronzée galvanique avec brossage manuel et vernis transparent brillant
Bronze_ Galvanische Bronzierung mit manueller Bürstung und transparenter Glanzlackierung
Бронза_ Гальваническое бронзирование с ручным брашированием и прозрачным глянцевым лаком
- 26** Rame satinato_ Finitura galvanica di Rame con spazzolatura manuale e verniciatura trasparente lucida
Satin copper_ Galvanic copper finish. handmade brushed, protected by transparent shiny paint
Cuivre satiné_ Finition galvanique du cuivre avec brossage manuel et vernis brillant transparent
Kupfer satiniert_ Galvanisches Finish von Kupfer mit manueller Bürstung und transparenter Glanzlackierung
Сатинированная медь_ Гальваническая отделка меди с ручным брашированием и прозрачным глянцевым лаком
- 27** Bronzo Opaco_ Finitura galvanica di bronzatura con spazzolatura manuale e verniciatura trasparente opaca
Matt bronze _Galvanic bronze finish. handmade brushed, protected by transparent matt paint
Bronze opaque_ Finition bronzée galvanique avec brossage manuel et vernis mat transparent
Opaque Bronze_ Galvanische Bronzierung mit manueller Bürstung und transparenter Mattlackierung
Опакое Bronze_ Гальваническая бронзовая отделка с ручным брашированием и прозрачным матовым лаком
- 28** Bronzo Scuro opaco_ Finitura galvanica di bronzatura scura con spazzolatura manuale e verniciatura trasparente opaca
Dark matt bronze _Galvanic dark bronze finish. handmade brushed, protected by transparent matt paint
Bronze foncé mat_ Finition galvanique complète avec brossage manuel et vernissage mat transparent
Dunkelbronze matt/ Vollgalvanik mit manueller Bürstung und transparenter Mattlackierung
Темная бронза матовая_ Полная гальваническая отделка с ручным брашированием и прозрачным матовым лаком
- 36** Nickel satinato lucido_ Finitura galvanica spazzolata manualmente e verniciata trasparente lucida
Shiny satin nickel _Galvanic finish. handmade brushed, protected by transparent shiny paint
Nickel satiné poli_ Finition galvanique brossée au doigt et vernis brillant transparent
Poliertes satiniertes Nickel_ Finger gebürstetes galvanisches Finish und transparenter Hochglanzlack
Полированный сатинированный никель_ Гальваническая отделка и прозрачный глянцевый лак
- 37** Nickel satinato opaco_ Finitura galvanica spazzolata manualmente e verniciata trasparente opaco
Matt satin nickel _Galvanic finish. handmade brushed, protected by transparent matt paint
Nickel satiné mat_ Finition galvanique brossée au doigt et vernis transparent mat
Nickel matt satiniert_ Finger gebürstetes galvanisches Finish und matt transparente Lackierung
Матовый сатинированный никель_ Гальваническая отделка и матовый прозрачный лак
- 56** Nickel nero lucido_ Finitura galvanica di nichel scuro verniciato trasparente lucido
Black shiny nickel _Galvanic finish, protected by transparent shiny paint
Nickel noir poli_ Nickel foncé fini galvanique avec revêtement transparent brillant
Glänzendes schwarzes Nickel_ Galvanisches dunkles Nickel mit transparenter, glänzender Beschichtung
Полированный черный никель_ Полированная гальваническая отделка темного никеля с прозрачным глянцевым покрытием
- 57** Nickel nero satinato lucido_ Finitura galvanica di nichel scuro con spazzolatura manuale, verniciato trasparente lucido
Black shiny satin nickel _ Galvanic finish. handmade brushed, protected by transparent shiny paint
Nickel noir satiné poli_ Finition nickel foncé galvanique avec brossage manuel, laque transparente polie
Schwarzer, satiniertes, poliertes Nickel_ Galvanisches, dunkles Nickel-Finish mit manuellem Bürsten, transparenter, polierter Lack
Черный сатинированный полированный никель_ Гальваническая отделка из темного никеля с ручным брашированием, прозрачный полированный лак
- 61** Nickel nero satinato opaco_ Finitura galvanica di nichel scuro con spazzolatura manuale, verniciata trasparente opaca
Black matt satin nickel _Galvanic finish. handmade brushed, protected by transparent matt paint
Nickel noir mat satiné_ Finition nickel foncé galvanique avec brossage manuel, vernis mat transparent
Schwarzer Nickel, seidenmatt/ Vollgalvanisiertes Dunkel-Nickel mit manuellem Bürsten, transparenter Mattlack
Сатинированный матовый черный никель_ Полное гальваническое покрытие темного никеля с ручным брашированием, прозрачный матовый лак

ARIA

_AZIONE COORDINATA

Designer: Massimiliano Settimelli
Materiale: Barra Ovale - 40x20
Accessori: Ceramica
Finitura: 08
Fuori misura: Sì

Designer: Massimiliano Settimelli
Material: Oval Brass Bar - cm 40x20
Accessories: Ceramic
Finishes: 08
Customized: Yes

Designer: Massimiliano Settimelli
Matériel: Laiton massif Bar Ovale - 40x20
Accessoires: céramique
Finitions: 08
Personnalisé: Oui

Designer: Massimiliano Settimelli
Material: Messing oval bar - 40x20
Zubehör: Keramik
Ausführungen: 08
Kundenwunsch: Ja

Дизайн: Massimiliano Settimelli
Материал: латунь, овальная форма - 40x20
Аксессуары: керамика
Отделка: 08 хром
Негабаритный: да

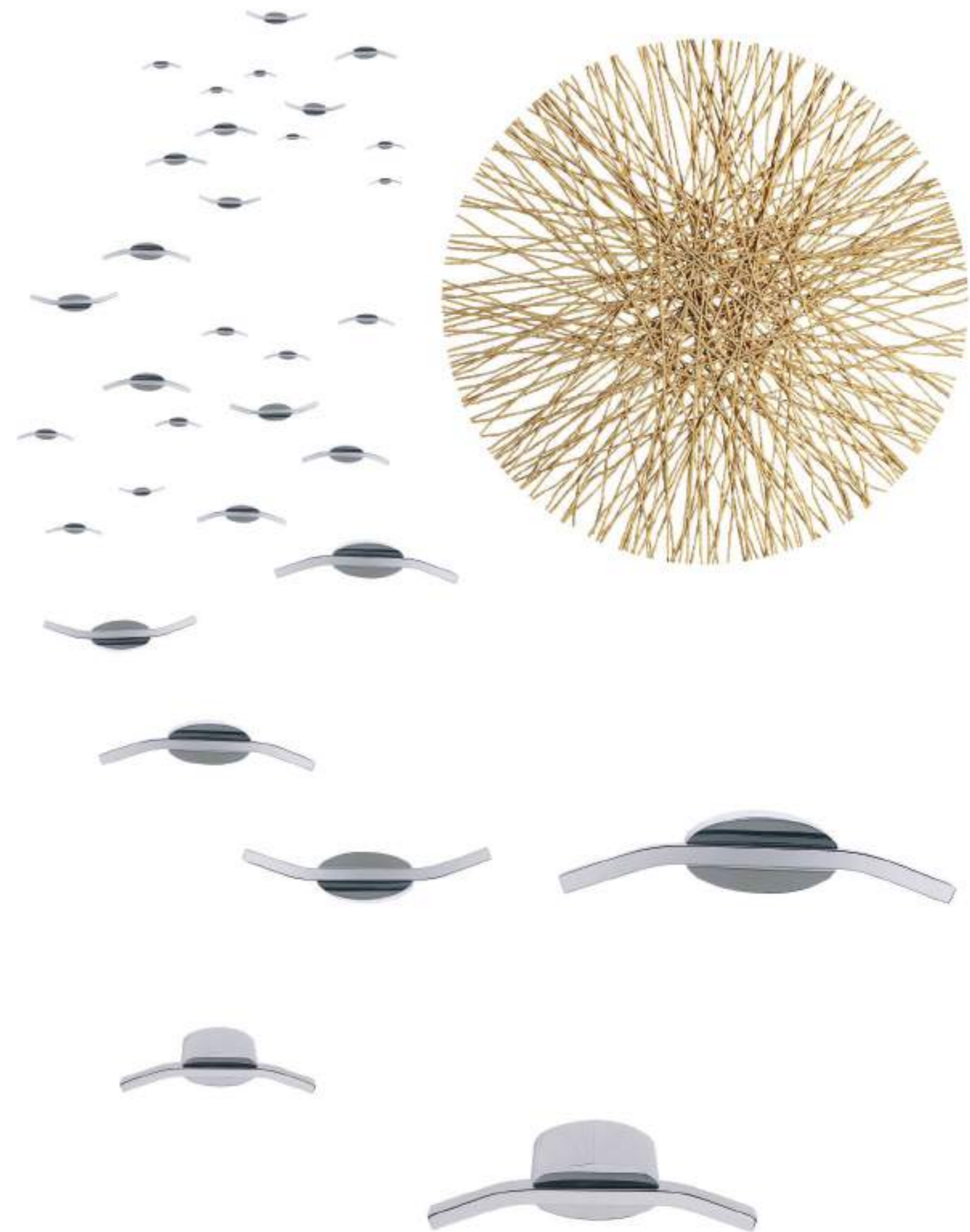



AR 11
AR 039 M



AR 14



AR 16



AR 45



AR 04

Mensola vetro 8 mm
Shelf
Étagère
Ablage
Стеклопанельная полка - толщина стекла 8 мм
cm 60 L x 13 P x 2 H

- 08



AR 05

Asta porta asciugamani
Towel rail
Porte serviettes
Handtuchhalter
Полотенцедержатель
cm 56 L x 7,5 P x 2 H - INT. 49

- 08



AR 45

Asta porta asciugamani
Towel rail
Porte serviettes
Handtuchhalter
Полотенцедержатель
cm 45 L x 7,5 P x 2 H - INT. 39

- 08



AR 06

Asta porta salviette
Towel rail
Porte serviettes
Handtuchhalter
Полотенцедержатель
cm 30 L x 7,5 P x 2 H - INT. 23

- 08



AR 11

Porta rotolo
Paper holder
Porte rouleau
Papierrollenhalter
Бумагодержатель
cm 18 L x 7,5 P x 2 H

- 08



AR 11 C

Porta rotolo con coperchio
Covered paper holder
Porte rouleau avec couvercle
Papierrollenhalter mit Deckel
Бумагодержатель с крышкой
cm 13 L x 13 P x 10 H

- 08



AR 039

Porta scopino ovale
Toilet-brush
Poret balayent d'appui
Bürstengarnitur freistehend
Напольный металлический ёрш
cm 10 L x 6,5 P x 47 H

- 08



AR 039 M

Porta scopino a parete
Wall mounted toilet-brush
Porte balayent à mur
Bürstengarnitur wandhängend
Настенный металлический ёрш
cm 10 L x 7,5 P x 47 H

- 08



AR 16

Porta asciugamani a snodo 2 aste
Towel rail with 2 adjustable bar
Porte serviettes à 2 barres orientables
Handtuchhalter schwenkbar 2 Stangen
Полотенцедержатель двойной поворотный
cm 34 L x 2,5 P x 8,5 H

- 08



AR 07

Anello porta salviette
Ring serviette holder
Porte serviettes à anneau
Handtuchring
Полотенцедержатель - полукольцо
cm 30 L x 7,5 P x 14,5 H

- 08



AR 09

Porta sapone a parete
Wall mounted soap dish
Porte savon à mur
Seifenschale wandhängend
Настенная керамическая мыльница
cm 18 L x 11 P x 4 H

-08bianco/white/blanc/weiß/белый
-08nero/black/noir/schwarz/черный



AR 10

Porta bicchiere a parete
Wall mounted glass holder
Porte verre à mur
Zahnbürstenhalter wandhängend
Настенный керамический стакан
cm 16 L x 10 P x 13 H

-08bianco/white/blanc/weiß/белый
-08nero/black/noir/schwarz/черный



AR 945

Porta scopino in ceramica
Ceramic Toilet-brush
Porte balayent en ceramique
Bürstengarnitur wandhängend
Напольный керамический ёрш
cm 13 L x 9 P x 46 H

-08bianco/white/blanc/weiß/белый
-08nero/black/noir/schwarz/черный



652

Porta sapone da appoggio
Soap dish with base
Porte savon d'appui
Seifenschale freistehend
Настольная керамическая мыльница
cm 13 L x 8 P x 2 H

-08bianco/white/blanc/weiß/белый
-08nero/black/noir/schwarz/черный



653

Bicchiere da appoggio
Glass with base
Verre d'appui
Zahnputzbecher freistehend
Настольный керамический стакан
cm 10 L x 7 P x 10 H

-08bianco/white/blanc/weiß/белый
-08nero/black/noir/schwarz/черный



654

Dosatore sapone d'appoggio
Soap dispenser with base
Porte savon d'appui
Seifenspender freistehend
Настольный керамический дозатор
cm 10 L x 7 P x 19 H

-08bianco/white/blanc/weiß/белый
-08nero/black/noir/schwarz/черный

OPZIONI E COMPLEMENTI / OPZIONI E COMPLEMENTI OPZIONI E COMPLEMENTI / OPZIONI E COMPLEMENTI



08-BI

CROMO - CER. BIANCO
Chrome - Cer. white
Chrome - Cér. blanc
Chrom - Ker. weiß
хром - белая керамика



08-NE

CROMO - CER. NERO
Chrome - Cer. black
Chrome - Cér. noir
Chrom - Ker. schwarz
хром - черная керамика



AR 30

Dosatore sapone liquido a parete
Wall mounted soap dispenser
Doseur de savon à mur
Seifenspender wandhängend
Настенный керамический дозатор
cm 16 L x 10 P x 21 H

-08bianco/white/blanc/weiß/белый
-08nero/black/noir/schwarz/черный



AR 14

Porta sapone e porta bicchiere a parete
Wall mounted soap dish and tumbler
Porte savon et porte verre à mur
Seifenschale und Zahnbürstenhalter wandhängend
Настенные керамические мыльница + стакан
cm 28 L x 11 P x 13 H

-08bianco/white/blanc/weiß/белый
-08nero/black/noir/schwarz/черный



AR 13

Porta accappatoio (2 ganci)
Robe hook (2 hooks)
Porte peignoir (2 crochets)
Bademantelhaken (2 Haken)
Крючок двойной
cm 10 L x 7,5 P x 2 H

- 08



AR 13.1

Porta accappatoio
Robe hook
Porte peignoir
Bademantelhaken
Крючок
cm 2 L x 5 P x 4 H

- 08



Reversibile su richiesta / Reversible on request / Réversible sur demande / Umkehrbar auf Anfrage / Реверсивный по запросу



Su richiesta si realizzano aste porta asciugamani su misura, 20 gg

Customized towel rails are available on request, 20 days
Des porte-serviettes personnalisés sont disponibles sur demande, 20 jours
Handtuchhalter sind auf Anfrage erhältlich, 20 Tagen
По запросу мы можем производить полотенцедержатели под размер 20 дней



- 08 25 → 44 cm
- 08 46 → 100 cm

BUCKET

_IL SUONO DEL DESIGN

Designer: Giovanna Talocci
Materiale: Piatto ottone / INOX 304 , 25x4
Accessori: ceramica bianca
Finiture: 02 - 03 - 05 - 08 - 20 - 23 - 24 - 54 - 58 - 59
Fuori misura: No

Designer: Giovanna Talocci
Material: Brass / stainless steel plate 304 , 25x4
Accessories: white ceramic
Finishes: 02 - 03 - 05 - 08 - 20 - 23 - 24 - 54 - 58 - 59
Customized: No

Designer: Giovanna Talocci
Matériel: Plaque en laiton / acier inoxydable 304, 25x4
Accessoires: blanc céramique
Finitions: 02 - 03 - 05 - 08 - 20 - 23 - 24 - 54 - 58 - 59
Personnalisé: No

Designer: Giovanna Talocci
Material: Messing-/Edelstahlplatte 304 , 25x4
Zubehör: weiße Keramik
Ausführungen: 02 - 03 - 05 - 08 - 20 - 23 - 24 - 54 - 58 - 59
Kundenwunsch: Nein

Дизайн: Giovanna Talocci
Материал: Пластина из латуни / нержавеющей стали 304, 25x4
Аксессуары: белая керамика
Отделка: 02 - 03 - 05 - 08 - 20 - 23 - 24 - 54 - 58 - 59
Негабаритный: нет





BK 45 08



BK 11 08



BK 13 08



BK 14 08





BK 45 54



BK 06 54



BK 11 54



BK 30 54 BI OP

BUCKET



BK 04

Mensola vetro
Shelf
Etagère
Ablage
Стеклянная полка
cm 60 L x 12 P x 5 H

• 23 - 24
• 08 - 54
• 02 - 03 - 05 - 20 - 58 - 59



BK 05

Asta porta asciugamani
Towel rail
Porte serviettes
Handtuchhalter
Полотенцедержатель
cm 56,5 L x 4 P x 3 H - INT. 54

• 23 - 24
• 08 - 54
• 02 - 03 - 05 - 20 - 58 - 59



BK 45

Asta porta asciugamani
Towel rail
Porte serviettes
Handtuchhalter
Полотенцедержатель
cm 45 L x 4 P x 3 H - INT. 43

• 23 - 24
• 08 - 54
• 02 - 03 - 05 - 20 - 58 - 59



BK 06

Asta porta salviette
Towel rail
Porte serviettes
Handtuchhalter
Полотенцедержатель
cm 34 L x 4 P x 3 H

• 23 - 24
• 08 - 54
• 02 - 03 - 05 - 20 - 58 - 59



BK 13

Porta accappatoio
Robe hook
Porte peignoir
Bademantelhaken
Крючок
cm 3 L x 4,5 P x 12 H

• 23 - 24
• 08 - 54
• 02 - 03 - 05 - 20 - 58 - 59



BK 11

Porta rotolo
Paper holder
Porte rouleau
Papierrollenhalter
Бумагодержатель
cm 20 L x 6 P x 3 H

• 23 - 24
• 08 - 54
• 02 - 03 - 05 - 20 - 58 - 59



BK 12 A

Porta scopino in ceramica
Ceramic Toilet-brush
Porte balayent en ceramique
Bürstengarnitur freisehend
Напольный керамический ёрш
cm Ø 10 x 42 H

• 23 - 24
• 08 - 54
• 02 - 03 - 05 - 20 - 58 - 59



BK 039 M

Porta scopino a parete
Wall mounted toilet-brush
Porte balayent à mur
Bürstengarnitur wandhängend
Настенный металлический ёрш
cm Ø 8 x 44 H

• 23 - 24
• 08 - 54
• 02 - 03 - 05 - 20 - 58 - 59



BK 07

Anello porta salviette
Ring serviette holder
Porte serviettes à anneau
Handtuchring
Полотенцедержатель - кольцо
cm 23 L x 7 P x 33 H

• 23 - 24
• 08 - 54
• 02 - 03 - 05 - 20 - 58 - 59



BK 09

Porta sapone a parete in ceramica
Wall-mounted ceramic soap dish
Porte-savon mural en céramique
Keramik-Seifenschale für die Wandmontage
Настенная керамическая мыльница
cm 17 L x 12 P x 6 H

• 23 - 24
• 08 - 54
• 02 - 03 - 05 - 20 - 58 - 59



BK 10

Porta bicchiere a parete in ceramica
Wall-mounted ceramic cup holder
Porte-gobelet mural en céramique
Keramik-Tassenhalter für die Wandmontage
Настенный керамический подстаканник
cm 15 L x 10 P x 13 H

• 23 - 24
• 08 - 54
• 02 - 03 - 05 - 20 - 58 - 59



BK 30

Dosatore sapone liquido a parete in ceramica
Wall-mounted ceramic liquid soap dispenser
Distributeur mural de savon liquide en céramique
Wandmontierter Flüssigseifenspender aus Keramik
Настенный керамический дозатор для жидкого мыла
cm 16 L x 10 P x 20 H

• 23 - 24
• 08 - 54
• 02 - 03 - 05 - 20 - 58 - 59



BK 14

Porta sapone e porta bicchiere a parete in ceramica
Wall-mounted ceramic soap dish and glass holder
Porte-savon mural en céramique et porte-verre
Keramikseifenschale und Glashalter für die Wandmontage
Настенная керамическая мыльница и держатель для стаканов
cm 30 L x 12 P x 13 H

• 23 - 24
• 08 - 54
• 02 - 03 - 05 - 20 - 58 - 59



BK 09 AP

Porta sapone da appoggio in ceramica
Ceramic countertop soap dish
Porte-savon de comptoir en céramique
Seifenschale aus Keramik für die Arbeitsplatte
Мыльница с керамической столешницей
cm Ø 12 x 3,5 H

• 08



BK 10 AP

Bicchiere da appoggio in ceramica
Ceramic table-top tumbler
Gobelet de table en céramique
Keramischer Tischbecher
Керамический настольный стакан
cm Ø 9 x 10 H

• 08



BK 30 AP

Dosatore sapone d'appoggio in ceramica
Ceramic soap dispenser
Distributeur de savon en céramique
Seifenspender aus Keramik
Керамический дозатор для мыла
cm Ø 9 x 18 H

• 08 - 23 - 24
• 02 - 58 - 20 - 54

OPZIONI E COMPLEMENTI / OPZIONI E COMPLEMENTI OPZIONI E COMPLEMENTI / OPZIONI E COMPLEMENTI / OPZIONI E COMPLEMENTI



23



NERO OPACO
Matt black
Noir opaque
Mattschwarz
черный матовый

24



BIANCO OPACO
Matt white
Blanc opaque
Weiße
белый матовый

08



CROMO
Chrome
Chrom
хром

02



CROMO + ORO
Chrome - Gold
Chrome - Or
Chrom - Gold
хром - золото

03



CROMO + BIANCO
Chrome - White
Chrome - Blanc
Chrom - Weiß
хром - белый

05



CROMO + NERO OPACO
Chrome - Matt black
Chrome - Noir mat
Chrom - Mattschwarz
Хром - матовый черный

58



CROMO + NICHEL NERO LUCIDO
Chrome - Nickel glossy black
Chrome - Nickel noir brillant
Chrom - Nickel glänzend schwarz
Хром - Никель глянцевый черный

20



CROMO + ORO OPACO
Chrome - Matt gold
Chrome - Or mat
Chrom - Mattgold
хром - матовое золото

59



NERO OPACO + ORO OPACO
Matt black - Matt gold
Noir mat - Or mat
Mattschwarz - Mattgold
матовое черное - матовое золото

54



ACCIAIO INOX 304 SATINATO
304 satin stainless steel
Acier inoxydable 304 satiné
Edelstahl 304 satiniert
304 сатинированная нержавеющая сталь

Disponibili in neolite opaco (maggiorazione)
Available in matt neolite (supplement)
Disponibile en néolite mat (supplément)
Erhältlich in mattem Neolith (Zuschlag)
Доступен в матовом неолитовом цвете (дополнительно)

BIOP



BIANCO OPACO
Matt white
Blanc mat
Mattweiß
матовый белый

NEOP



NERO OPACO
Matt black
Noir mat
Mattschwarz
матовый черный

DIANA

_LA FORZA DELLO STILE

Designer: Stilhaus
Materiale: Ottone, tubo ovale 20x10, basetta a muro 50x42
Accessori: Vetro Satinato
Finitura: O8
Fuori misura: Si
Incollo : Si

Designer: Stilhaus
Material: Brass, tube 20x10, fixing plate cover 50x42
Accessories: Frosted glass
Finishes: O8
Customized: Yes
By glue : Yes

Designer: Stilhaus
Matière: Laiton, tuyau 20x10, boucle couvre-vis 50x42
Accessoires: verre satin
Finitions: O8
Personnalisé: Oui
Par collage : Oui

Designer: Stilhaus
Material: Messing, Rohr 20x10,
Befestigungsplatten Oberfläche 50x42
Zubehör: Mattglas
Ausführungen: O8
Kundenwunsch: Ja
Kleber: Ja

Дизайн: Stilhaus
Материал: латунь
Аксессуары: сатиновое
стекло
Отделка: O8 хром
Негабаритный: да
Установка на клей: да





DI06



DI 16



DI 11



DI 09
DI 10
DI 30



DI 04

Mensola vetro 8mm
Shelf
Etagère
Ablage
Стеклоплатформа - толщина стекла 8mm
cm 56 L x 13,5 P x 4 H

- 08



DI 05

Asta porta asciugamani
Towel rail
Porte serviettes
Handtuchhalter
Полотенцедержатель
cm 63 L x 7 P x 4 H - INT. 55

- 08



DI 45

Asta porta asciugamani
Towel rail
Porte serviettes
Handtuchhalter
Полотенцедержатель
cm 48 L x 7 P x 4 H - INT. 43

- 08



DI 06

Asta porta salviette
Towel rail
Porte serviettes
Handtuchhalter
Полотенцедержатель
cm 33 L x 7 P x 4 H - INT. 28

- 08



DI 809

Porta accappatoio (2 ganci)
Robe hook (2 hooks)
Porte peignoir (2 crochets)
Bademantelhaken (2 Haken)
Крючок
cm 5,5 L x 5,5 P x 5,5 H

- 08



DI 11

Porta rotolo
Paper holder
Porte rouleau
Papierrollenhalter
Бумагодержатель
cm 16,5 L x 7,5 P x 4 H

- 08



DI 11 C

Porta rotolo con coperchio
Covered paper holder
Porte rouleau avec couvercle
Papierrollenhalter mit Deckel
Бумагодержатель с крышкой
cm 17 L x 10 P x 9 H

- 08



DI 039 M

Porta scopino a parete
Wall-mounted toilet-brush
Porte balayent à mur
Bürstengarnitur oval wandhängend
Настенный металлический ёрш
cm Ø 8 x 40,5 H

- 08



DI 16

Porta asciugamani snodo 2 aste
Towel rail with 2 adjustable bar
Porte serviettes à 2 barres orientables
Handtuchhalter schwenkbar 2 Stangen
Полотенцедержатель двойной поворотный
cm 3 L x 33 P x 9 H

- 08



DI 07

Anello porta salviette
Ring serviette
Porte serviettes à anneau
Handtuchring
Полотенцедержатель - кольцо
cm 20,5 Ø x 6,5 P x 22,5 H

- 08



DI 09

Porta sapone a parete
Wall mounted soap dish
Porte savon à mur
Seifenschale wandhängend
Настенная стеклянная мыльница
cm 13 L x 11 P x 4 H

- 08



DI 10

Porta bicchiere in vetro a parete
Wall-mounted glass holder
Porte verre à mur
Zahnputzhalter wandhängend
Настенный стеклянный стакан
cm 7,5 L x 11 P x 11 H

- 08



DI 039

Porta scopino da appoggio
Toilet-brush with base
Porte balayent d'appui
Bürstengarnitur freistehend
Напольный металлический ёрш
cm Ø 8 x 40,5 H

- 08



840

Kit collante e biadesivo per un articolo
Kit with bi-adhesive and glue for one article
Kit avec collant et biadhésif pour un article
Klebekit ist ein beidseitiger Klebestreifen
Клей

- 08



DI 30

Dosatore sapone liquido a parete
Wall soap dispenser
Doseur de savon à mur
Seifenspender wandhängend
Настенный стеклянный дозатор
cm 8 L x 11 P x 19 H

- 08



917

Porta sapone ovale da appoggio
Leaning oval soap dish
Porte savon ovale d'appui
Seifenschale oval freistehend
Настольная металлическая мыльница
cm 14 L x 8,5 P x 2 H

- 08



918

Bicchieri ovale da appoggio
Leaning oval glass
Verre ovale d'appui
Zahnputzbecher oval freistehend
Настольный металлический стакан
cm 5,5 L x 8 P x 11 H

- 08



919

Dosatore sapone liquido da appoggio
Leaning liquid soap dispenser
Porte savon liquid d'appui
Seifenspender freistehend
Настольный металлический дозатор
cm 5,5 L x 8 P x 16 H

- 08

OPZIONI E COMPLEMENTI / OPZIONI E COMPLEMENTI / OPZIONI E COMPLEMENTI / OPZIONI E COMPLEMENTI / OPZIONI E COMPLEMENTI

↔ Reversibile su richiesta / Reversible on request / Réversible sur demande / Umkehrbar auf Anfrage / Реверсивный по запросу



08

CROMO
Chrome
Chrome
Chrom
хром



Su richiesta si realizzano aste porta asciugamani su misura, 20 gg

Customized towel rails are available on request, 20 days
Des porte-serviettes personnalisés sont disponibles sur demande, 20 jours
Handtuchhalter sind auf Anfrage erhältlich, 20 Tagen
По запросу мы можем производить полотенцедержатели под размер 20 дней



- 08 25 → 47 cm

- 08 49 → 100 cm

DIVA

_IL BELLO SI VEDE
IL FASCINO SI SENTE

Designer: MASSIMILIANO SETTIMELLI
Materiale: ottone, TUBO 12x12, basetta a muro 50 x 50
Accessori: ceramica bianca
Finiture: O8
Fuori misura: Sì
Incollo: Sì

Designer: Massimiliano Settimelli
Material: Brass Bar 12x12,
fixing plate cover 50x50
Accessories: white ceramic
Finishes: O8
Customized: Yes
By glue: Yes

Designer: Massimiliano Settimelli
Matière: Laiton, tuyau 12x12, boucle couvre-vis 50x50
Accessoires: Blanc céramique
Finitions: O8
Personnalisé: Oui
Par collage: Oui

Designer: Massimiliano Settimelli
Material: Messing Rohr 12x12,
befestigungsplatten oberfläche 50x50
Zubehör: Weiße keramik
Ausführungen: O8
Kundenwunsch: Ja
Kleber: Ja

Дизайн: Massimiliano Settimelli
Материал: латунь
Аксессуары: белая керамика
Отделка: O8 хром
Негабаритный: да
Установка на клей: да





DV 45



DV 07



DV 10
DV 30



DV 04

Mensola 8 mm
Shelf
Etagère
Ablage
Стекло́нная полка - толщина стекла 8 mm
cm 60 L x 11 P x 2 H x 50 INT

- 08



DV 05

Asta porta asciugamani
Towel rail
Porte serviettes
Handtuchhalter
полотенцедержатель + керамическая мыльница
cm 61 L x 9 P x 5 H x 56,5 INT

- 08



DV 45

Asta porta asciugamani
Towel rail
Porte serviettes
Handtuchhalter
полотенцедержатель
cm 46 L x 9 P x 5 H x 41,5 INT

- 08



DV 06

Asta porta salviette
Towel rail
Porte serviettes
Handtuchhalter
Полотенцедержатель
cm 36,5 L x 9 P x 5 H x 31,5 INT

- 08



DV 69

Asta con porta sapone
Towel rail with soap dish
Porte serviettes avec porte savon
Handtuchhalter mit Seifenschale
Полотенцедержатель + керамическая мыльница
cm 40 L x 12 P x 5 H x 31,5 INT

- 08



DV 69 D

Asta con dosatore di sapone
Towel rail with liquid soap dispenser
Porte serviettes avec dosator de savon
Handtuchhalter mit Seifenspender
Полотенцедержатель + керамический дозатор
cm 40 L x 11 P x 2 H x 31,5 INT

- 08



DV 07

Anello porta salviette
Serviette holder to ring shaped
Porte serviettes à anneau
Handtuchring
полотенцедержатель - кольцо
cm 25 L x 6 P x 21 H

- 08



DV 16

Porta asciugamani a snodo 2 aste
Towel rail with 2 adjustable bar
Porte serviettes à 2 barres orientables
Handtuchhalter schwenkbar 2 Stangen
Полотенцедержатель двойной поворотный
cm 33 L x 11 P x 2 H x 5 INT

- 08



DV 09

Porta sapone a parete
Wall ceramic soap dish
Porte savon en céramique
Seifenschale wandhängend
Настенная керамическая мыльница
cm 13 L x 10 P x 6 H

- 08



DV 10

Porta bicchiere a parete
Wall tooth brush holder
Porte verre en céramique
Zahnbürstenhalter wandhängend
Настенный керамический стакан
cm 8 L x 10 P x 15 H

- 08



DV 30

Porta dosatore sapone liquido in ceramica
Ceramic liquid soap dispenser holder
Doseur de savon liquid en céramique
Seifenspender aus Keramik
Настенный керамический дозатор
cm 8 L x 8 P x 18 H

- 08



DV 14

Porta sapone e porta bicchiere a parete
Wall mounted soap dish and tumbler
Porte savon et porte verre à mur
Seifenschale und Zahnbürstenhalter wandhängend
Настенные керамические мыльница + стакан
cm 23 L x 10 P x 15 H

- 08



DV 11
DV 12 A



DV 09 AP
 Porta sapone d'appoggio
 Soap dish
 Porte savon
 Seifenschale
 Настольная керамическая мыльница
 cm 12 L x 8 P x 2 H

- 08



DV 10 AP
 Bicchiere d'appoggio
 Glass
 Verre
 Zahnputzbecher
 Настольный керамический стакан
 cm 9L x 8 P x 11,5 H

- 08



DV 30 AP
 Dosatore sapone liquido d'appoggio
 Liquid soap dispenser
 Porte savon liquid
 Seifenspender
 Настольный керамический дозатор
 cm 9 L x 8,5 P x 18 H

- 08



DV 14 AP
 Vaschetta porta oggetti
 Tray plateau tablet
 Tablet
 Tablet
 Настольный керамический лоток
 cm 20 L x 10 P x 2 H

- 08



DV 13
 Porta accappatoio
 Robe hook
 Porte peignoir
 Bademantelhaken
 Крючок
 cm 5 L x 6 P x 5 H

- 08



DV 11
 Porta rotolo
 Paper holder
 Porte rouleau
 Papierrollenhalter
 бумагодержатель
 cm 18 L x 9 P x 5 H

- 08



DV 11C
 Porta rotolo con coperchio
 Covered paper holder
 Porte rouleau avec couvercle
 Papierrollenhalter mit Deckel
 бумагодержатель с крышкой
 cm 13 L x 14 P x 12 H

- 08



DV 11 S
 Porta rotolo scorta
 Paper holder of supply
 Porte rouleau s'escorte
 Ersatzpapierrollenhalter
 Настенный вертикальный бумагодержатель
 cm 5 L x 9 P x 18 H

- 08



DV 69



DV 12 A
 Porta scopino d'appoggio in ceramica
 Ceramic toilet brush
 Porte balayent en ceramique
 Bürstengarnitur freistehend aus keramik
 Напольный керамический ёрш
 cm 10 L x 10 P x 40 H

- 08



DV 039 M
 Porta scopino a parete
 Wall ceramic toilet brush
 Porte balayent à mur
 Bürstengarnitur wandhängend
 Настенный металлический ёрш
 cm 8 L x 8 P x 39 H

- 08



DV 039
 Porta scopino d'appoggio
 Ceramic toilet brush
 Porte balayent
 Bürstengarnitur freistehend
 Напольный металлический ёрш
 cm 8 L x 8 P x 39 H

- 08



840
 Kit collante e biadesivo per un articolo
 Kit with bi-adhesive and glue for one article
 Kit avec collant et biadhésif pour un article
 Klebekit ist ein beidseitiger Klebestreifen
 Клей

-

OPZIONI E COMPLEMENTI / OPZIONI E COMPLEMENTI / OPZIONI E COMPLEMENTI / OPZIONI E COMPLEMENTI



Su richiesta si realizzano aste porta asciugamani su misura, 15 gg

Customized towel rails are available on request, 15 days
 Des porte-serviettes personnalisés sont disponibles sur demande, 15 jours
 Handtuchhalter sind auf Anfrage erhältlich, 15 tagen
 По запросу мы можем производить полотенцедержатели под размер 15 дней



- 08 25 → 45 cm
 - 08 47 → 100 cm



> pag. 274



> pag. 254



> pag. 309



> pag. 425



> pag. 425

EQUILIBRIUM

_GUSTO DI STILE

Designer: Gianluca Paludi
Materiale: Marmo - Resina - Ottone
Accessori: Marmo - Resina
Finiture: 08 - 17 - 18 - 23 - 36
Fuori misura: No

Designer: Gianluca Paludi
Material: Marble - Resin - Brass
Accessories: Marble - Resin
Finishes: 08 - 17 - 18 - 23 - 36
Customized: No

Designer: Gianluca Paludi
Matière: Marbre - Résine - Laiton
Accessoires: Marbre - Résine
Finitions: 08 - 17 - 18 - 23 - 36
Personnalisé: Non

Designer: Gianluca Paludi
Material: Marmor - Kunstharz - Messing
Zubehör: Marmor - Harz
Ausführungen: 08 - 17 - 18 - 23 - 36
Kundenwunsch: No

Дизайн: Gianluca Paludi
Материал: Мрамор - Смола - Латунь
Аксессуары: Мрамор - Смола
Отделка: 08 - 17 - 18 - 23 - 36
Негабаритный: No





EQM 05 18



EQM 11 08



EQM 13 23



EQM06/11SX36



EQR 05 23



EQR 13 08



EQR 06 DX 36



EQR 06/11 SX 18

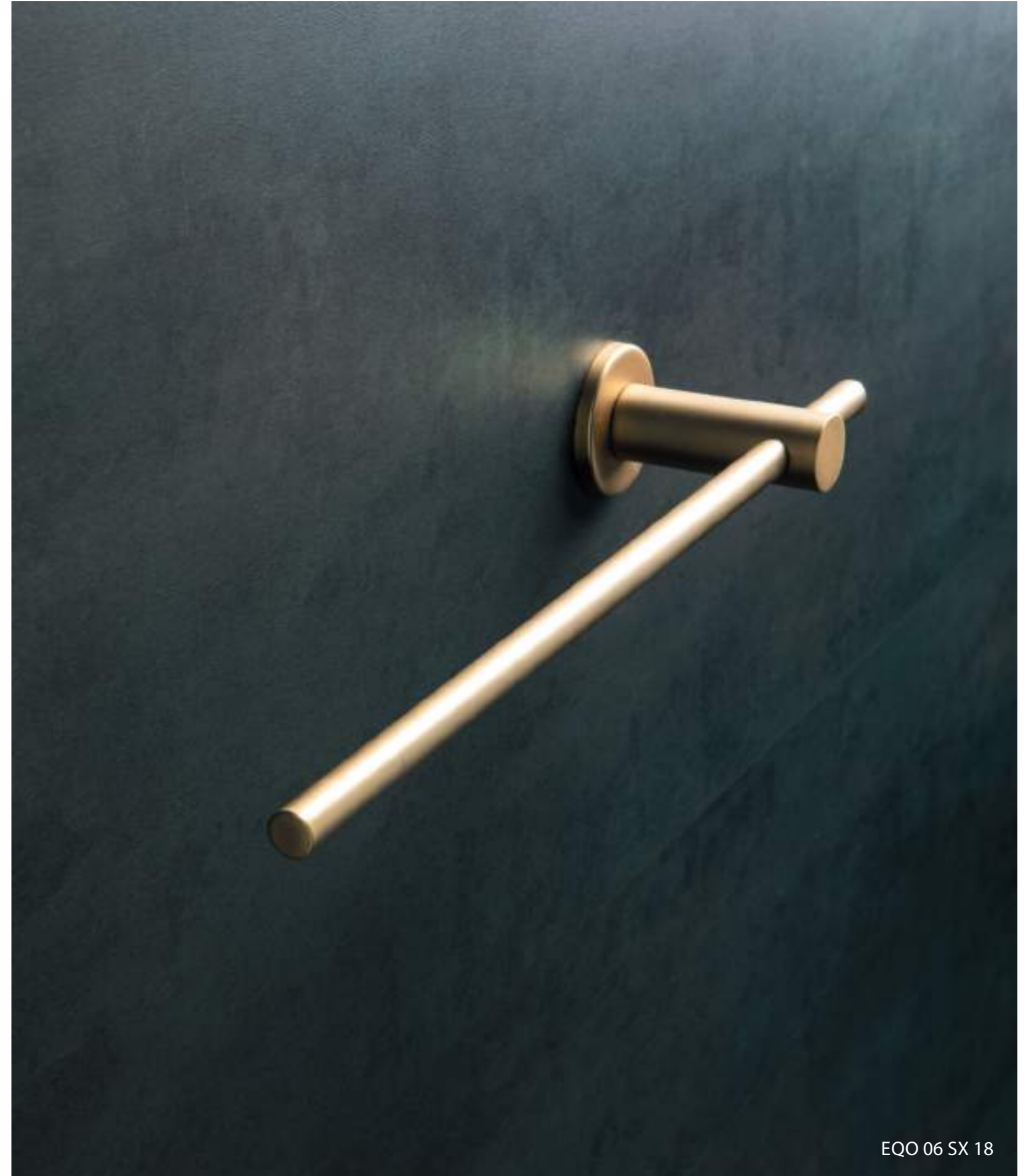

**EQM 05**

Asta porta salviette
Towel rail
Porte serviettes
Handtuchhalter
Полотенцедержатель
cm 50 L x 7 P x 5 H

• 08 - 23
• 18 - 36
• 17

**EQM 06 DX**

Asta porta salviette
Towel rail
Porte serviettes
Handtuchhalter
Полотенцедержатель
cm 35 L x 7 P x 5 H

• 08 - 23
• 18 - 36
• 17

**EQM 06 SX**

Asta porta salviette
Towel rail
Porte serviettes
Handtuchhalter
Полотенцедержатель
cm 35 L x 7 P x 5 H

• 08 - 23
• 18 - 36
• 17

**EQM 06 / 11 DX**

Asta porta salviette
Towel rail
Porte serviettes
Handtuchhalter
Полотенцедержатель
cm 45 L x 7 P x 5 H

• 08 - 23
• 18 - 36
• 17

**EQM 06 / 11 SX**

Porta salviette con porta rotolo sinistro
Towel rail with left-hand roll holder
Porte-serviettes avec porte-rouleau à gauche
Handtuchhalter mit Rollenhalter links
Полотенцесушитель с левосторонним держателем рулона
cm 45 L x 7 P x 5 H

• 08 - 23
• 18 - 36
• 17

**EQM 10 AP**

Bicchieri in Marmo
Marble glass
Verre marbré
Marmoriertes Glas
Мраморное стекло
cm Ø 7,5 x 13 H

•

**EQM 30 AP**

Dosatore sapone liquido in Marmo
Marble liquid soap dispenser
Distributeur de savon liquide en marbre
Flüssigseifenspender aus Marmor
Мраморный дозатор для жидкого мыла
cm Ø 7,5 x 17 H

• 08 - 23
• 18 - 36
• 17

**EQM 11**

Porta rotolo
Paper holder
Porte rouleau
Papierrollenhalter
Бумагодержатель
cm 21 L x 7 P x 5 H

• 08 - 23
• 18 - 36
• 17

**EQM 13**

Porta accappatoio (2 ganci)
Robe hook (2 hooks)
Porte pegnoir (2 crochets)
Bademantelhaken
Крючок двойной
cm 13 L x 7 P x 5 H

• 08 - 23
• 18 - 36
• 17

**EQM 12 AP**

Porta scopino da appoggio
Toilet-brush with base
Porte balayent d'appui
Bürstengarnitur freistehend
Напольный металлический ёрш
cm Ø 12 x 45 H

• 08 - 23
• 18 - 36
• 17

**1239**

Piantana: porta rotolo e scopino
Freestanding unit: toilet roll holder and toilet brush
Lampadaire : porte-rouleau de papier toilette et brosse de toilette
Stehleuchte: Toilettenpapierhalter und Toilettenbürste
Напольный светильник: держатель для туалетного рулона и щетка для унитаза
cm Ø 12 x 14,5 L x 56 H

• 08 - 23
• 18 - 36
• 17

**1240**

Piantana: porta rotolo
Free-standing upright: paper holder
Support : porte-rouleau
Ständer: Rollenhalter
Подставка: держатель рулона
cm Ø 12 x 14,5 L x 56 H

• 08 - 23
• 18 - 36
• 17

**1241**

Piantana: porta rotolo, porta salviette e scopino
Free-standing upright: paper holder, towel rail and toilet-brush holder
Unité autonome : porte-rouleau de papier toilette, porte-serviette et brosse de toilette
Freistehende Einheit: Toilettenpapierhalter, Handtuchhalter und Toilettenbürste
Отдельно стоящее устройство: держатель рулона туалетной бумаги, полотенцедержатель и туалетный ершик
cm Ø 12 x 36 L x 80 H

• 08 - 23
• 18 - 36
• 17

**1242**

Piantana: porta rotolo e porta salviette
Free-standing upright: paper holder and Towel rail
Sur pied : porte-rouleau de papier toilette et porte-serviette
Stehleuchte: Toilettenpapier- und Handtuchhalter
Напольный светильник: держатель для туалетного рулона и полотенца
cm Ø 12 x 36 L x 80 H

• 08 - 23
• 18 - 36
• 17

**1243**

Piantana: scopino, dosatore sapone, porta asciugamani e porta rotolo
Free-standing upright: toilet brush holder, soap dispenser, towel holder and paper holder
Montant autonome: porte balayent, doseur de savon, porte serviette et porte rouleau
Ständer: Bürstengarnitur, Flüssigseifenspender, Handtuchhalter und Papierrollenhalter
Стойка: мыльница + полотенцедержатель + бумагодержатель + ёрш металлический
cm Ø 12 x 36 L x 84 H

• 08 - 23
• 18 - 36
• 17

**1244**

Piantana porta asciugamani
Free-standing upright towel rail
Porte-serviettes
Handtuchhalter
Подставка для полотенца
cm Ø 12 x 45 L x 80 H

• 08 - 23
• 18 - 36
• 17

OPZIONI E COMPLEMENTI / OPZIONI E COMPLEMENTI OPZIONI E COMPLEMENTI / OPZIONI E COMPLEMENTI / OPZIONI E COMPLEMENTI

**08**

CROMO
Chrome
Chrome
Chrom
хром

18

ORO OPACO
Matt gold
Or opaque
Opak gold
Золото

23

NERO OPACO
Matt black
Noir opaque
Mattschwarz
черный матовый

36

NICHEL SATINATO
Satin nickel
Nickel satiné
Nickel satiniert
Никель сатин

17

ORO ROSA
Pink gold
Or rose
Rosé gold
белый матовый

**EQR 05**

Asta porta salviette
Towel rail
Porte serviettes
Handtuchhalter
Полотенцедержатель
cm 50 L x 7 P x 5 H

- 08 - 23
- 18 - 36
- 17

**EQR 06 DX**

Asta porta salviette
Towel rail
Porte serviettes
Handtuchhalter
Полотенцедержатель
cm 32,5 L x 7 P x 5 H

- 08 - 23
- 18 - 36
- 17

**EQR 06 SX**

Asta porta salviette
Towel rail
Porte serviettes
Handtuchhalter
Полотенцедержатель
cm 32,5 L x 7 P x 5 H

- 08 - 23
- 18 - 36
- 17

**EQR 06 / 11 DX**

Asta porta salviette
Towel rail
Porte serviettes
Handtuchhalter
Полотенцедержатель
cm 45 L x 7 P x 5 H

- 08 - 23
- 18 - 36
- 17

**EQR 06 / 11 SX**

Porta salviette con porta rotolo sinistro
Towel rail with left-hand roll holder
Porte-serviettes avec porte-rouleau à gauche
Handtuchhalter mit Rollenhalter links
Полотенцесушитель с левосторонним держателем рулона
cm 45 L x 7 P x 5 H

- 08 - 23
- 18 - 36
- 17

**1204**

Porta sapone in Neolite
Neolite soap dish
Porte-savon en néolite
Seifenschale aus Neolith
Неолитовая мыльница
cm - Ø 12 x 3 H

- BI
- NE

**1205**

Bicchieri in Neolite
Neolite glass
Verre de néolite
Neolith-Glas
Неолитовое стекло
cm - Ø 7,5 x 13 H

- BI
- NE

**1206**

Dosatore sapone liquido in Neolite
Marble liquid soap dispenser
Distributeur de savon liquide en marbre
Flüssigseifenspender aus Marmor
Мраморный дозатор для жидкого мыла
cm - Ø 7,5 x 17 H

- BI / 08 - 23
- BI / 18 - 36
- BI / 17
- NE / 08 - 23
- NE / 18 - 36
- NE / 17

**EQR 11**

Porta rotolo
Paper holder
Porte rouleau
Papierrollenhalter
Бумагодержатель
cm 21 L x 7 P x 5 H

- 08 - 23
- 18 - 36
- 17

**EQR 13**

Porta accappatoio (2 ganci)
Robe hook (2 hooks)
Porte pegnoir (2 crochets)
Bademantelhaken
Крючок двойной
cm 13 L x 7 P x 5 H

- 08 - 23
- 18 - 36
- 17

**EQR 12 AP**

Porta scopino da appoggio
Toilet-brush with base
Porte balayent d'appui
Bürstengarnitur freistehend
Напольный металлический ёрш
cm Ø 15 x 40 H

- 08 - 23
- 18 - 36
- 17

NEOP

NERO OPACO
Matt black
Noir mat
Mattschwarz
матовый черный



Disponibili in neolite opaco (maggiorazione)
Available in matt neolite (supplément)
Erhältlich in mattem Neolith (Zuschlag)
Доступен в матовом неолитовом цвете
(дополнительно)

**1302**

Piantana: porta rotolo e scopino
Freestanding unit: toilet roll holder and toilet brush
Lampadaire : porte-rouleau de papier toilette et brosse de toilette
Stehleuchte: Toilettenpapierhalter und Toilettenbürste
Напольный светильник: держатель для туалетного рулона и щетка для унитаза
cm Ø 12 x 14,5 L x 56 H

- 08 - 23
- 18 - 36
- 17

**1303**

Piantana: porta rotolo
Free-standing upright: paper holder
Support : porte-rouleau
Ständer: Rollenhalter
Подставка: держатель рулона
cm Ø 12 x 14,5 L x 56 H

- 08 - 23
- 18 - 36
- 17

**1304**

Piantana: porta rotolo, porta salviette e scopino
Free-standing upright: paper holder, towel rail and toilet-brush holder
Unité autonome : porte-rouleau de papier toilette, porte-serviette et brosse de toilette
Freistehende Einheit: Toilettenpapierhalter, Handtuchhalter und Toilettenbürste
Отдельно стоящее устройство: держатель рулона туалетной бумаги, полотенецедержатель и туалетный ершик
cm Ø 12 x 36 L x 80 H

- 08 - 23
- 18 - 36
- 17

**1305**

Piantana: porta rotolo e porta salviette
Free-standing upright: paper holder and Towel rail
Sur pied : porte-rouleau de papier toilette et porte-serviette
Stehleuchte: Toilettenpapier- und Handtuchhalter
Напольный светильник: держатель для туалетного рулона и полотенца
cm Ø 12 x 36 L x 80 H

- 08 - 23
- 18 - 36
- 17

**1306**

Piantana: scopino, dosatore sapone, porta asciugamani e porta rotolo
Free-standing upright: toilet brush holder, soap dispenser, towel holder and paper holder
Montant autonome: porte balayent, doseur de savon, porte serviette et porte rouleau
Ständer: Bürstengarnitur, Flüssigseifenspender, Handtuchhalter und Papierrollenhalter
Стойка: мыльница + полотенецедержатель + бумагодержатель + ёрш металлический
cm Ø 12 x 36 L x 84 H

- 08 - 23
- 18 - 36
- 17

**1307**

Piantana porta asciugamani
Free-standing upright towel rail
Porte-serviettes
Handtuchhalter
Подставка для полотенец
cm Ø 12 x 45 L x 80 H

- 08 - 23
- 18 - 36
- 17

OPZIONI E COMPLEMENTI / OPZIONI E COMPLEMENTI / OPZIONI E COMPLEMENTI / OPZIONI E COMPLEMENTI / OPZIONI E COMPLEMENTI**08**

CROMO
Chrome
Chrome
Chrom
хром

18

ORO OPACO
Matt gold
Or opaque
Orak gold
Золото

23

NERO OPACO
Matt black
Noir opaque
Mattschwarz
черный матовый

36

NICHEL SATINATO
Satin nickel
Nickel satiné
Nickel satiniert
Никель сатин

17

ORO ROSA
Pink gold
Or rose
Rosé gold
белый матовый

**EQO 05**

Asta porta salviette
Towel rail
Porte serviettes
Handtuchhalter
Полотенцедержатель
cm 50 L x 7 P x 5 H

• 08 - 23
• 18 - 36
• 17

**EQO 06 DX**

Asta porta salviette
Towel rail
Porte serviettes
Handtuchhalter
Полотенцедержатель
cm 35 L x 7 P x 5 H

• 08 - 23
• 18 - 36
• 17

**EQO 06 SX**

Asta porta salviette
Towel rail
Porte serviettes
Handtuchhalter
Полотенцедержатель
cm 35 L x 7 P x 5 H

• 08 - 23
• 18 - 36
• 17

**EQO 06 / 11 DX**

Asta porta salviette
Towel rail
Porte serviettes
Handtuchhalter
Полотенцедержатель
cm 45 L x 7 P x 5 H x

• 08 - 23
• 18 - 36
• 17

**EQO 06 / 11 SX**

Porta salviette con porta rotolo sinistro
Towel rail with left-hand roll holder
Porte-serviettes avec porte-rouleau à gauche
Handtuchhalter mit Rollenhalter links
Полотенцесушитель с левосторонним держателем рулона
cm 45 L x 7 P x 5 H

• 08 - 23
• 18 - 36
• 17

**HS 10 AP**

Bicchiere da appoggio
Glass with base
Verre d'appui
Zahnputzbecher freistehend
Настольный металлический стакан
cm Ø 6,5 x 11,5 H

• 08 - 23
• 18 - 36
• 17

**HS 30 AP**

Dosatore sapone d'appoggio
Soap dispenser with base
Porte savon d'appui
Seifenspender freistehend
Настольный металлический дозатор
cm Ø 6,5 x 18 H

• 08 - 23
• 18 - 36
• 17

**EQO 11**

Porta rotolo
Paper holder
Porte rouleau
Papierrollenhalter
Бумагодержатель
cm 21 L x 7 P x 5 H

• 08 - 23
• 18 - 36
• 17

**EQO 13**

Porta accappatoio (2 ganci)
Robe hook (2 hooks)
Porte pegnoir (2 crochets)
Bademantelhaken
Крючок двойной
cm 13 L x 7 P x 5 H

• 08 - 23
• 18 - 36
• 17

**1946**

Porta scopino a parete
Wall-mounted toilet-brush
Porte balayent à mur
Bürstengarnitur oval wandhängend
Настенный металлический ёрш
cm Ø 6,5 x 40H

• 08 - 23
• 18 - 36
• 17

**1246**

Piantana: porta rotolo e scopino
Free-standing upright: paper holder and toilet-brush holder
Montant autonome: porte rouleau et porte balayent
Ständer: Papierrollenhalter und Bürstengarnitur
Стойка: бумагодержатель+ёрш металлический
cm Ø 13 x 14,5 L x 56 H

• 08 - 23
• 18 - 36
• 17

**1247**

Piantana: porta rotolo
Stand: roll holder
Support : porte-rouleau
Ständer: Rollenhalter
Подставка: держатель рулона
cm Ø 13 x 14,5 L x 56 H

• 08 - 23
• 18 - 36
• 17

**1248**

Piantana: porta rotolo, porta salviette e scopino.
Free-standing upright: paper holder, towel rail and toilet-brush holder.
Unité autonome : porte-rouleau de papier toilette, porte-serviette et brosse de toilette
Handtuchleiter
полотенцедержатель напольный
cm Ø 17 x 36 L x 78 H

• 08 - 23
• 18 - 36
• 17

**1249**

Piantana: porta rotolo e porta salviette
Free-standing upright: paper holder and Towel rail
Sur pied : porte-rouleau de papier toilette et porte-serviette
Stehleuchte: Toilettenpapier- und Handtuchhalter
Напольный светильник: держатель для туалетного рулона и полотенца
cm Ø 17 x 36 L x 79 H

• 08 - 23
• 18 - 36
• 17

**1250**

Piantana: scopino ottone, dosatore sapone, porta asciugamani e porta rotolo
Free-standing upright: toilet brush holder, soap dispenser, towel holder and paper holder
Montant autonome: porte balayent, porte savon liquid, porte serviette et porte rouleau
Ständer: Bürstengarnitur, Seifenschale, Handtuchhalter und Papierrollenhalter
Стойка: мыльница + полотенецдержатель + бумагодержатель + ёрш металлический
cm Ø 17 x 36 L x 84 H

• 08 - 23
• 18 - 36
• 17

**1251**

Piantana porta asciugamani
Towel stand
Porte-serviettes
Handtuchhalter
Подставка для полотенца
cm Ø 22 x 45 L x 79 H

• 08 - 23
• 18 - 36
• 17

OPZIONI E COMPLEMENTI / OPZIONI E COMPLEMENTI OPZIONI E COMPLEMENTI / OPZIONI E COMPLEMENTI / OPZIONI E COMPLEMENTI

**08**

CROMO
Chrome
Chrome
Chrom
хром

18

ORO OPACO
Matt gold
Or opaque
Opak gold
Золото

23

NERO OPACO
Matt black
Noir opaque
Mattschwarz
черный матовый

36

NICHEL SATINATO
Satin nickel
Nickel satiné
Nickel satiniert
Никель сатин

17

ORO ROSA
Pink gold
Or rose
Rosé gold
белый матовый

GEA

_GRANDI OPERE

Designer: Stilhaus
Materiale: Barra ottone pieno 30x20
Accessori: Ceramica bianca
Finiture: 08 - 18 - 57
Fuori misura: Sì

Designer: Stilhaus
Material: Solid brass bar 30x20
Accessories: White ceramic
Finishes: 08 - 18 - 57
Customized: Yes

Designer: Stilhaus
Matériel: Laiton massif bar 30x20
Accessoires: Blanc céramique
Finitions: 08 - 18 - 57
Personnalisé: Oui

Designer: Stilhaus
Material: Aus massivem messing bar 30x20
Zubehör: Weiße keramik
Ausführungen: 08 - 18 - 57
Kundenwunsch: Ja

Дизайн: Stilhaus
Материал: латунь
Аксессуары: белая керамика
Отделка: 08 - 18 - 57
Негабаритный: да





GE 69



GE 16



GE 11
GE 12

**GE 04**

Mensola 8 mm
Shelf
Etagère
Ablage
Стекло́нная полка - толщина стекла 8 mm
cm 60 L x 13 P x 2 H x 50 INT

• 08
• 18 - 57

**GE 05**

Asta porta asciugamani
Towel rail
Porte serviettes
Handtuchhalter
полотенцедержатель
cm 56 L x 8 P x 2 H x 49 INT

• 08
• 18 - 57

**GE 45**

Asta porta asciugamani
Towel rail
Porte serviettes
Handtuchhalter
полотенцедержатель
cm 45 L x 8 P x 2 H x 38 INT

• 08
• 18 - 57

**GE 06**

Asta porta salviette
Towel rail
Porte serviettes
Handtuchhalter
Полотенцедержатель
cm 30 L x 8 P x 2 H x 23 INT

• 08
• 18 - 57

**GE 69**

Asta cm 45 con porta sapone DX
Towel rail with soap dish
Porte serviettes avec porte savon
Handtuchhalter mit Seifenschale
Полотенцедержатель +
керамическая мыльница
cm 47,5 L x 9 P x 5 H x 38 INT

• 08
• 18 - 57

**GE 69 D**

Asta cm 45 con dosatore di sapone DX
Towel rail with liquid soap dispenser
Porte serviettes avec dosator de savon
Handtuchhalter mit Seifenspender
Полотенцедержатель +
керамический дозатор
cm 46 L x 8 P x 22 H x 38 INT

• 08
• 08 A
• 18 A - 57 A

**GE 16**

Porta asciugamani a snodo 2 aste
Towel rail with 2 adjustable bar
Porte serviettes à 2 barres orientables
Handtuchhalter schwenkbar 2 Stangen
Полотенцедержатель двойной
поворотный
cm 31 L x 3,5 P x 5 H

• 08
• 18 - 57

**GE 07**

Anello porta salviette
Serviette holder to ring shaped
Porte serviettes à anneau
Handtuchring
Полотенцедержатель - полукольцо
cm 25 L x 8 P x 12 H

• 08
• 18 - 57

**GE 79**

Anello porta salviette con sapone
Serviette holder with soap
Porte serviettes à anneau avec savon
Handtuchhalter + Seifenschale wandhängend
Полотенцедержатель - полукольцо +
керамическая мыльница
cm 25 L x 9 P x 14 H

• 08
• 18 - 57

**GE 79 D**

Anello porta salviette con dosatore sapone
Serviette holder with soap dispenser
Porte serviettes à anneau avec doseur de savon
Handtuchhalter + Seifenspender wandhängend
Полотенцедержатель - полукольцо +
керамический дозатор
cm 25 L x 8 P x 31 H

• 08
• 08 A
• 18 A - 57 A

**GE 09**

Porta sapone a parete
Wall ceramic soap dish
Porte savon en céramique
Seifenschale wandhängend
Настенная керамическая мыльница
cm 12 L x 9 P x 5 H

• 08
• 18 - 57

**GE 10**

Porta bicchiere a parete
Wall tooth brush holder
Porte verre en céramique
Zahnbürstenhalter wandhängend
Настенный керамический стакан
cm 9 L x 8 P x 16 H

• 08
• 18 - 57



GE 07



GE 30

Dosatore sapone a parete
Wall liquid soap dispenser holder
Doseur de savon liquid en céramique
Seifenspender
Настенный керамический дозатор
cm 9 L x 8 P x 22 H

- 08
- 08 A
- 18 A - 57 A



GE 09 AP

Porta sapone d'appoggio
Soap dish
Porte savon
Seifenschale
Настольная керамическая мыльница
cm 12 L x 8 P x 2 H

- 08



GE 10 AP

Bicchieri d'appoggio
Ceramic glass
Verre en céramique d'appui
Zahnputzbecher
Настольный керамический стакан
cm 9 L x 7 P x 13 H

- 08



GE 30 AP

Dosatore sapone liquido d'appoggio
Ceramic liquid soap dispenser
Porte savon liquid en céramique
Seifenspender
Настольный керамический дозатор
cm 9 L x 6,9 P x 19 H

- 08
- 08 A
- 18 A - 57 A



GE 13

Porta accappatoio
Robe hook
Porte peignoir
Bademantelhaken
Крючок
cm 2 L x 3 P x 3 H

- 08
- 18 - 57



GE 13.2

Porta accappatoio (2 ganci)
Robe hook (2 hooks)
Porte peignoir (2 crochets)
Bademantelhaken
Крючок двойной
cm 10 L x 8 P x 2 H

- 08
- 18 - 57



GE 11

Porta rotolo
Paper holder
Porte rouleau
Papierrollenhalter
Бумагодержатель
cm 19 L x 8 P x 2 H

- 08
- 18 - 57



GE 11 C

Porta rotolo con coperchio
Covered paper holder
Porte rouleau avec couvercle
Papierrollenhalter mit Deckel
Бумагодержатель с крышкой
cm 13 L x 13 P x 10 H

- 08
- 18 - 57



GE 11.2

Porta rotolo doppio
Double paper holder
Porte rouleau double
Papierrollenhalter doppelt
Бумагодержатель двойной
cm 30 L x 8 P x 2 H

- 08
- 18 - 57



GE 11 S

Porta rotolo scorta
Paper holder of supply
Porte rouleau s'escorte
Ersatzpapierrollenhalter
Бумагодержатель вертикальный
cm 3 L x 8 P x 18 H

- 08
- 18 - 57



GE 12 A

Porta scopino d'appoggio in ceramica
Ceramic toilet brush
Porte balaynet en ceramique
Bürstengarnitur freistehend aus Keramik
Напольный керамический ёрш
cm 10 L x 10 P x 42 H

- 08
- 18 - 57



GE 039 M

Porta scopino a parete
Wall ceramic toilet brush
Porte balaynet à mur
Bürstengarnitur wandhängend
Настенный металлический ёрш
cm 8 L x 8 P x 43 H

- 08
- 18 - 57



GE 13.2

OPZIONI E COMPLEMENTI / OPZIONI E COMPLEMENTI OPZIONI E COMPLEMENTI / OPZIONI E COMPLEMENTI / OPZIONI E COMPLEMENTI

* FINITURA DISPONIBILE IN 20 GG. / Finish available in 20 days / Finition disponible en 20 jours / Oberfläche lieferbar in 20 Tagen / Отделка доступна в течение 20 дней



08



CROMO
Chrome
Chrome
Chrom
хром

18*



ORO OPACO
Matt gold
Or opaque
Opak gold
Золото

57*

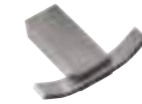

NICKEL NERO SATINATO
Satin black nickel
Nickel noir satiné
Nickel mattschwarz
атласный чёрный никель



Reversibile su richiesta / Reversible on request / Réversible sur demande / Umkehrbar auf Anfrage / Реверсивный по запросу



Su richiesta si realizzano aste porta asciugamani su misura, 20 gg

Customized towel rails are available on request, 20 days
Des porte-serviettes personnalisés sont disponibles sur demande, 20 jours
Handtuchhalter sind auf Anfrage erhältlich, 20 tagen
По запросу мы можем производить полотенцедержатели под размер 20 дней



- 08 25 → 44 cm
- 08 47 → 100 cm
- 18-57 25 → 44 cm
- 18-57 47 → 100 cm



HASHI

_ATTENZIONE MISURATA

Designer: Gianluca Paludi
Materiale: Barra ottone Ø 14 e Ø 8
Finiture: 08 - 17 - 18 - 23 - 24 - 36 - 56
Fuori misura: Sì

Designer: Gianluca Paludi
Material: Solid Brass Bar Ø14 and Ø8
Finishes: 08 - 17 - 18 - 23 - 24 - 36 - 56
Customized: Yes

Designer: Gianluca Paludi
Matériel: laiton massif Bar Ø14 e Ø8
Finitions: 08 - 17 - 18 - 23 - 24 - 36 - 56
Personnalisé: Oui

Designer: Gianluca Paludi
Material: aus massivem Messing Bar Ø14 und Ø8
Ausführungen: 08 - 17 - 18 - 23 - 24 - 36 - 56
Kundenwunsch: Ja

Дизайнер: Gianluca Paludi
Материал: латунь
Аксессуары: белая керамика
Покрытие: 08 - 17 - 18 - 23 - 24 - 36 - 56
Негабаритный: да





HS 45



HS 11



HS 13



HS 09
HS 10
HS 30



HS 11 17
010 17



HS 11 56
HS 06 56



HS 07 24



HS 10 AP 23
HS 30 AP 23

HS 11 23
HS 06 23



HS 45 18



HS 10 AP 36
HS 30 AP 36



HS 04
Mensola acciaio Inox
Inox Shelf
Etagère en Inox
Ablage
Полка из нержавеющей стали
cm 60 L x 12 P x 3 H

• 08 - 23 - 24



HS 05
Asta porta asciugamani
Towel rail
Porte serviettes
Handtuchhalter
Полотенцедержатель
cm 60 L x 7 P x 3 H - INT. 57

• 08 - 23 - 24
• 18 - 56
• 17



HS 45
Asta porta asciugamani
Towel rail
Porte serviettes
Handtuchhalter
Полотенцедержатель
cm 45 L x 7 P x 3 H - INT. 42

• 08 - 23 - 24
• 18 - 56
• 17



HS 06
Asta porta salviette
Towel rail
Porte serviettes
Handtuchhalter
Полотенцедержатель
cm 30 L x 7 P x 3 H - INT. 27

• 08 - 23 - 24
• 18 - 56
• 17



HS 13
Porta accappatoio
Robe hook
Porte peignoir
Bademantelhaken
Крючок
cm 2 L x 4,5 P x 2 H

• 08 - 23 - 24
• 18 - 56
• 17



HS 11
Porta rotolo
Paper holder
Porte rouleau
Papierrollenhalter
Бумагодержатель
cm 20 L x 6 P x 3 H

• 08 - 23 - 24
• 18 - 56
• 17



O10
Porta scopino
Toilet-brush
Porte balayent
Bürstengarnitur freistehend
Напольный керамический ёрш
cm Ø 8 x 40 H

• 08 - 23 - 24
• 18 - 56
• 17



O10 M
Porta scopino a parete
Wall mounted toilet-brush
Porte balayent à mur
Bürstengarnitur wandhängend
Настенный металлический ёрш
cm Ø 8 x 40 H

• 08 - 23 - 24
• 18 - 56
• 17



HS 07
Anello porta salviette
Ring serviette holder
Porte serviettes à anneau
Handtuchring
Полотенцедержатель - кольцо
cm Ø 20 x 7 P

• 08 - 23 - 24
• 18 - 56
• 17



HS 09 M
Porta sapone a parete
Wall mounted soap dish
Porte savon à mur
Seifenschale wandhängend
Настенная металлическая мыльница
cm Ø 11 x 14 P x 3,5 H

• 08 - 23 - 24
• 18 - 56
• 17



HS 10 M
Porta bicchiere a parete
Wall mounted glass holder
Porte verre à mur
Zahnbürstenhalter wandhängend
Настенный металлический стакан
cm Ø 6 x 11,5 H

• 08 - 23 - 24
• 18 - 56
• 17



HS 30 M
Dosatore sapone liquido a parete
Wall mounted soap dispenser
Doseur de savon à mur
Seifenspender wandhängend
Настенный металлический дозатор
cm Ø 6 x 18 H

• 08 - 23 - 24
• 18 - 56
• 17



HS 00
Basetta di rifinitura a muro
Plate
Rondelle murale
Scheibe
Отражатели
cm Ø 3

• 08 - 23 - 24
• 18 - 56
• 17



HASHI
Designer: Gianluca Paludi

OPZIONI E COMPLEMENTI / OPZIONI E COMPLEMENTI OPZIONI E COMPLEMENTI / OPZIONI E COMPLEMENTI / OPZIONI E COMPLEMENTI

* FINITURA DISPONIBILE IN 20 GG. / Finish available in 20 days / Finition disponible en 20 jours / Oberfläche lieferbar in 20 Tagen / Отделка доступна в течение 20 дней



08

CROMO
Chrome
Chrome
Chrom
хром



24

BIANCO OPACO
Matt white
Blanc opaque
Weiße
белый матовый



23

NERO OPACO
Matt black
Noir opaque
Mattschwarz
черный матовый



18*

ORO OPACO
Matt gold
Or opaque
Opak gold
хром



17*

ORO ROSA
Pink gold
Or rose
Rosé gold
белый матовый



HS 16
Porta asciugamani snodo 2 aste
Towel rail with 2 adjustable bar
Porte serviettes à 2 barres orientables
Handtuchhalter schwenkbar 2 Stangen
Полотенцедержатель двойной поворотный
cm 3 L x 33 P x 8 H

• 08 - 23 - 24
• 18 - 56
• 17



HS 09 AP
Porta sapone da appoggio
Soap dish with base
Porte savon d'appui
Seifenschale freistehend
Настольная металлическая мыльница
cm Ø 11 x 3,5 H

• 08
• 18 - 23 - 24 - 56
• 17



HS 10 AP
Bicchiere da appoggio
Glass with base
Verre d'appui
Zahnputzbecher freistehend
Настольный металлический стакан
cm Ø 6 x 11,5 H

• 08 - 23 - 24
• 18 - 56
• 17



HS 30 AP
Dosatore sapone d'appoggio
Soap dispenser with base
Porte savon d'appui
Seifenspender freistehend
Настольный металлический дозатор
cm Ø 6 x 18 H

• 08 - 23 - 24
• 18 - 56
• 17



36*

NICKEL SATINATO
Satin nickel
Nickel satiné
Nickel satiniert
Сатинированный никель



56*

NICKEL NERO
Black nickel
Nickel noir
Schwarzer Nickel
черный матовый

KREA

_MECCANICA DI SETTORE

Designer: Paolo Galletti e Daniele Maltinti
Materiale: Piatto inox 304
Accessori: Ceramica bianca
Finiture: 54 - 23
Combinazioni: 4000
Modello registrato N. 402017000142123

Designer: Paolo Galletti e Daniele Maltinti
Material: Inox 304
Accessories: White ceramic
Finishes: 54 - 23
Combinations: 4000
European patent model No.402017000142123

Designer: Paolo Galletti e Daniele Maltinti
Matériel: Inox 304
Accessoires: Blanc céramique
Finitions: 54 - 23
Combinaisons: 4000
Brevet Européen modèle No. 402017000142123

Designer: Paolo Galletti e Daniele Maltinti
Material: Inox 304
Zubehör: Weiße keramik
Ausführungen: 54 - 23
Kombinationen: 4000
Europäisches Patent modell Nr. 402017000142123

Разработка дизайна: Paolo Galletti e Daniele Maltinti
Материал: латунь 30x20
Аксессуары: белая керамика
Отделка: 54 - 23
комбинации: 4000
европейский патент модель No 402017000142123





SOL 1



SOL 2



SOL 3

**KR 00**

Attacco a parete
Bracket for wall
Support mural
Wandhalterung
крепление к стене
cm Ø 7

- 54 - 23

**KR 01**

Finale
Final part
Partie finale
Abschlussenteil
наконечники
cm Ø 4 x 2 P

- 54 - 23

**KR 06**

Asta 28
Tower rail
Porte serviettes
Handtuchhalter
Полотенцедержатель
cm 40 L x 7,5 H

- 54 - 23

**KR 09**

Porta sapone
Soap dish
Porte savon
Seifenschale
Настенная керамическая мыльница
cm 17 L x 13 P x 15 H

- 54 - 23

**KR 10**

Porta bicchiere
Glass
Verre
Zahnputzbecher
Настенный керамический стакан
cm 13 L x 6 P x 19 H

- 54 - 23

**KR 30**

Dosatore sapone liquido
Liquid soap dispenser
Porte savon liquid
Seifenspender
Настенный керамический дозатор
cm 13 L x 11 P x 21 H

- 54 - 23

**KR 08**

Mensola porta oggetti
Shelf
Étagère portant des objets
Regal
полка для настольных предметов
cm 19 L x 11 P x 17 H

- 54 - 23

**KR 13 P**

Porta accappatoio corto
Robe hook
Porte peignoir
Bademantelhaken
Крючок
cm 15 L x 4 P x 8 H

- 54 - 23

**KR 13 G**

Porta accappatoio lungo
Robe hook
Porte peignoir
Bademantelhaken
Крючок
cm 27 L x 4 P x 8 H

- 54 - 23

**KR 11**

Porta rotolo
Paper holder
Porte rouleau
Papierrollenhalter
Бумагодержатель
cm 18 L x 8 P x 7,5 H

- 54 - 23

**KR 039 M**

Porta scopino a parete
Wall mounted toilet-brush
Porte balaynet à mur
Bürstengarnitur wandhängend
Настенный металлический ёрш
cm 8 L x 8,5 P x 56 H

- 54 - 23



SOL 4



SOL 01
• 54 - 23



SOL 2
• 54 - 23



SOL 3
• 54 - 23



SOL 4
• 54 - 23



SOL 5
• 54 - 23



SOL 6
• 54 - 23



SOL 7
• 54 - 23



SOL 8
• 54 - 23



SOL 9
• 54 - 23



SOL 10
• 54 - 23



SOL 11
• 54 - 23



SOL 12
• 54 - 23



SOL 13
• 54 - 23



SOL 14
• 54 - 23



SOL 15
• 54 - 23



SOL 16
• 54 - 23



SOL 17
• 54 - 23



CONFIGURA LA TUA KREA CON LA NOSTRA APP

Configure your Krea with our App
Configurez votre Krea avec notre application
Konfigurieren sie ihr Krea mit unserer App
Настройте свой KREA с нашим APP

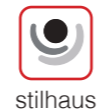

SOL 5



SOL 6



SOL 7



SOL 8



SOL 9



SOL 10



SOL 11



SOL 12



SOL 13



SOL 14

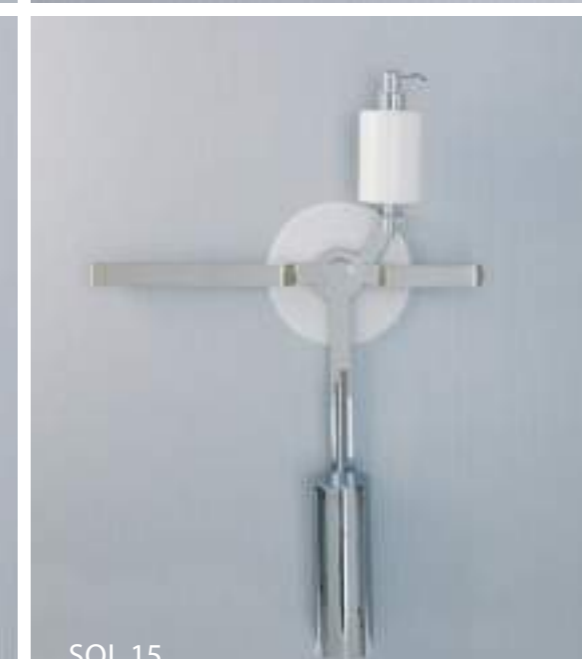

SOL 15



SOL 16



SOL 17



KR DEC 1

Decoro
Decorum
Decorum
Dekor-Rosette
декор
cm Ø 20

- BI - NE - BL - VE - RO - AR
- LG



BI

NE

BL

VE



KR DEC 2

Decoro
Decorum
Decorum
Dekor-Rosette
декор
cm 20 L x 20 H

- BI - NE
- LG



BI

NE

LG



KR DEC 3

Decoro
Decorum
Decorum
Dekor-Rosette
декор
cm 30 L x 20 H

- BI - NE
- LG



BI

NE

LG



RO

AR

LG

ESEMPIO
EXAMPLE
EXEMPLE
BEISPIEL
Пример



A



B



C

- | | | |
|---|---------------|------------------------------------|
| A | KR 00 + KR 01 | KR DEC 1 + KR 10 + KR 30 + KR 06 |
| B | KR 00 + KR 01 | KR DEC 2 + KR 30 + KR 10 + KR 13 G |
| C | KR 00 + KR 01 | KR 11 + KR 039 |

SCHEMA DI MONTAGGIO

Assembly scheme / Schéma d'assemblage / Montageschema / Схема сборки



KREA: Modello registrato N. 402017000142123
KREA: European patent model N.402017000142123
KREA: Brevet Européen modèle N. 402017000142123
KREA: Europäisches Patent modell Nr. 402017000142123
KREA: KREA: Европейский патент модель No 402017000142123

OPZIONI E COMPLEMENTI / OPZIONI E COMPLEMENTI OPZIONI E COMPLEMENTI / OPZIONI E COMPLEMENTI / OPZIONI E COMPLEMENTI



54

ACCIAIO SATINATO
Satin steel
Acier satiné
Stahl satiniert
сатинированная сталь

23

NERO OPACO
Matt black
Noir opaque
Mattschwarz
черный матовый

LIZ

_MAGNETISMO CONSAPEVOLE

Designer: Massimiliano Settimelli
Materiale: Ottone, tubo ø16, basetta a muro Ø 50
Accessori: Ceramica bianca
Finitura: 08
Fuori misura: Sì
Incollo : Sì

Designer: Massimiliano Settimelli
Material: Brass tube Ø 16, fixing plate cover Ø 50
Accessories: White ceramics
Finishes: 08
Customized: Yes
By glue : Yes

Designer: Massimiliano Settimelli
Matière: Laiton, tuyau Ø 16, boucle couvre-vis Ø 50
Accessoires: Céramique blanche
Finitions: 08
Personnalisé: Oui
Par collage : Oui

Designer: Massimiliano Settimelli
Material: Messing Rohr Ø 16,
Befestigungsplatten Oberfläche Ø 50
Zubehör: Weiße Keramik
Ausführungen: 08
Kundenwunsch: Ja
Kleber: Ja

Дизайн: Massimiliano Settimelli
Используемый Материал: латунь Ø 16, Ø 50
Аксессуары: сатинованное стекло Отделка: 08
хром Негабаритный: да
Установка на клей: да





LZ 45



LZ 13



LZ 11



LZ 09
LZ 10



LZ 04

Mensola vetro 8mm
Shelf
Étagère
Ablage
Стеклопанельная полка- толщина стекла 8 мм
cm 60 L x 12 P x 5 H

- 08



LZ 05

Asta porta asciugamani
Towel rail
Porte serviettes
Handtuchhalter
Полотенцедержатель
cm 63 L x 8 P x 5 H x 58 INT

- 08



LZ 05.2

Asta porta asciugamani con 2 aste
Chromed towel rail with 2 bar
Porte serviettes chromée à 2 barres
Handtuchhalter 2 Stangen
Полотенцедержатель двойной
cm 65 L x 13 P x 6 H x 60 INT

- 08



LZ 45

Asta porta asciugamani
Towel rail
Porte serviettes
Handtuchhalter
Полотенцедержатель
cm 50 L x 8 P x 5 H x 45 INT

- 08



LZ 45.2

Asta porta asciugamani con 2 aste
Chromed towel rail with 2 bar
Porte serviettes chromée à 2 barres
Handtuchhalter 2 Stangen
Полотенцедержатель двойной
cm 48 L x 13 P x 6 H x 43 INT

- 08



LZ 06

Asta porta salviette
Towel rail
Porte serviettes
Handtuchhalter
Полотенцедержатель двойной
cm 36 L x 8 P x 5 H x 31 INT

- 08



LZ 06.2

Asta porta salviette con 2 aste
Chromed towel rail with 2 bar
Porte serviettes chromée à 2 barres
Handtuchhalter 2 Stangen
Полотенцедержатель двойной
cm 36 L x 8 P x 6 H x 31 INT

- 08



LZ 06.1

Asta porta salvietta singola
Single towel rail
Porte serviettes
Handtuchhalter
Полотенцедержатель
cm 5,5 L x 30 P x 5,5 H

- 08



LZ 45.2



LZ 16

Porta asciugamani snodo 2 aste
Towel rail with 2 adjustable bar
Porte serviettes à 2 barres orientables
Handtuchhalter schwenkbar 2 Stangen
Полотенцедержатель двойной поворотный
cm 3 L x 33 P x 8 H

- 08



LZ 07

Anello porta salviette
Ring serviette holder
Porte serviettes à anneau
Handtuchring
Полотенцедержатель - кольцо
cm 20,5 Ø x 4,5 P x 22,5 H

- 08



LZ 09

Porta sapone a parete
Wall-mounted soap dish
Porte savon à mur
Seifenschale wandhängend
Настенная керамическая
cm 13,5 L x 10,5 P x 9 H

- 08



LZ 09 M

Porta sapone a parete
Wall-mounted soap dish
Porte savon à mur
Seifenschale
Настенная металлическая мыльница
cm 12 L x 10 P x 5 H

- 08



LZ 10

Porta bicchiere a parete
Wall-mounted glass holder
Porte verre à mur
Zahnbürstenhalter wandhängend
Настенный керамический
cm 8 L x 11 P x 17 H

- 08



LZ 30

Dosatore sapone liquido a parete
Wall-mounted soap dispenser
Doseur de savon
Seifenspender
Настенный керамический дозатор
cm 8 L x 11 P x 23 H

- 08



LZ 09 AP

Porta sapone d'appoggio
Soap dish
Porte savon
Seifenschale
Настольная керамическая мыльница
cm 13,5 L x 9 P x 2 H

- 01



LZ 10 AP

Bicchiere d'appoggio
Glass
Verre
Zahnputzbecher
Настольный керамический стакан
cm Ø 8 x 11,5 H

- 01



**LZ 30 AP**

Dosatore sapone liquido d'appoggio
Liquid soap dispenser
Porte savon liquid
Seifenspender
Настольный керамический дозатор
cm Ø 8 x 17 H

- 08

**LZ 34**

Supporto: p. sapone/bicchiere/dosatore
Support: soap/glass/soap dispenser holder
Supporte: p. savon/verre/doseur
Halter: Seifenschale/Zahnputzbecher/Seifenspender
Настенный держатель для мыльницы/дозатора /стакана
cm 7 L x 10 P x 5 H

- 08

**LZ 35**

Supporto doppio: p. sapone/bicchiere/dosatore
Double support: soap/glass/soap dispenser holder
Supporte double: p. savon/verre/doseur
Doppelhalter: Seifenschale/Zahnputzbecher/Seifenspender
Настенный держатель двойной для мыльницы/дозатора/стакана
cm 22 L x 10 P x 5 H

- 08

**LZ 041.08**

Porta sapone in vetro
Glass soap dish
Porte savon en verre
Seifenschale aus Glas
Стеклянная мыльница
cm 12 L x 12 P x 4 H

- 08

**LZ 11 S**

Porta rotolo di scorta
Supply paper holder
Porte rouleau d'escorte
Ersatzpapierrollenhalter
Напольный вертикальный
cm 7 L x 10 P x 23 H

- 08

**LZ 11.2**

Porta rotolo doppio
Double paper holder
Porte rouleau double
Papierrollenhalter doppelt
Бумагодержатель двойной
cm 26 L x 7 P x 4,5 H

- 08

**LZ 039**

Porta scopino da appoggio
Toilet-brush with base
Porte balayent d'appui
Bürstengarnitur freistehend
Напольный металлический ёрш
cm 8 L x 8 P x 40 H

- 08

**LZ 039 M**

Porta scopino a parete
Wall mounted toilet-brush
Porte balayent à mur
Bürstengarnitur wandhängend
Настенный металлический ёрш
cm 8 L x 9 P x 40 H

- 08

- 08 - incollo

**LZ 040.06**

Bicchiere in vetro
Glass holder
Porte verre
Zahnbürstenhalter aus Glas
Стеклянный стакан
cm 6 L x 6 P x 8 H

- 08

**LZ 037.01**

Dosatore sapone liquido in vetro con pompetta metallo
Glass liquid soap dispenser with chrome pump
Doseur de savon liquid en verre avec pompe
Seifenspender aus Glas
Стеклянный дозатор
cm 8 L x 8 P x 9 H

- 08

**LZ 13**

Porta accappatoio
Robe hook
Porte peignoir
Bademantelhaken
Крючок
cm 5,5 L x 2 P x 5,5 H

- 08

**LZ 809**

Porta accappatoio (2 ganci)
Robe hook (2 hooks)
Porte peignoir (2 crochets)
Bademantelhaken (2 Haken)
Крючок гнутый
cm 5,5 L x 5,5 P x 5,5 H

- 08

**VE 039 PRATIKO**

Porta scopino da appoggio con manico telescopico
Toilet-brush with telescopic handle
Porte balayent d'appui avec poignée télescopique
Bürstengarnitur freistehend mit Teleskopgriff
Напольный металлический ёрш
cm 12 L x 12 P x 52,5 H

- 08

**VE 039 M PRATIKO**

Porta scopino a parete con manico telescopico Pratico
Wall mounted toilet-brush with telescopic handle
Porte balayent à mur avec poignée télescopique
Bürstengarnitur wandhängend mit Teleskopgriff
Настенный стеклянный ёрш
cm 9 L x 12 P x 48 H

- 08

**VE 12**

Porta scopino a parete con manico telescopico Pratico
Wall mounted toilet-brush with telescopic handle
Porte balayent à mur avec poignée télescopique
Bürstengarnitur wandhängend mit Teleskopgriff
Настенный стеклянный ёрш
cm 9 L x 12 P x 48 H

- 08

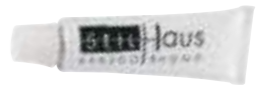
**840**

Kit collante e biadesivo per un articolo
Kit with bi-adhesive and glue for one article
Kit avec collant et biadhésif pour un article
Klebekit ist ein beidseitiger Klebestreifen
Возможность установки на клей.Ыфдгрш

- 08

**VE 13**

Porta accappatoio
Robe hook
Porte peignoir
Bademantelhaken
Крючок
cm 2 L x 4 P x 2 H

- 08

**VE 13.3**

Porta accappatoio (3 ganci)
Robe hook (3 hooks)
Porte peignoir (3 crochets)
Bademantelhaken (3 Haken)
Крючок тройной
cm 15 L x 4 P x 2 H

- 08

**LZ 11**

Porta rotolo
Paper holder
Porte rouleau
Papierrollenhalter
Бумагодержатель
cm 19 L x 8 P x 5 H

- 08

**LZ 11 C**

Porta rotolo coperto
Covered paper holder
Porte rouleau avec couvercle
Papierrollenhalter mit Deckel
Бумагодержатель с крышкой
cm 14 L x 12 P x 13 H

- 08

OPZIONI E COMPLEMENTI / OPZIONI E COMPLEMENTI OPZIONI E COMPLEMENTI / OPZIONI E COMPLEMENTI / OPZIONI E COMPLEMENTI

Reversibile su richiesta / Reversible on request / Réversible sur demande / Umkehrbar auf Anfrage / Реверсивный по запросу

**Su richiesta si realizzano aste porta asciugamani su misura, 20 gg**

Customized towel rails are available on request, 20 days
Des porte-serviettes personnalisés sont disponibles sur demande, 20 jours
Handtuchhalter sind auf Anfrage erhältlich, 20 Tagen
По запросу мы можем производить полотенцедержатели под размер 20 дней

- 08 25 → 45 cm

- 08 47 → 100 cm



> pag. 278



> pag. 342



> pag. 342



> pag. 342



> pag. 342



LIVING

_TEMPO DI STILE

Designer: BGR Industrial design
Materiale: Barra alluminio 20x12 e ottone Ø 20
Accessori: Ceramica bianca
Finiture: 03-05-08
Fuori misura: No

Designer: BGR Industrial design
Material: Solid aluminum 20x12 and brass
Accessories: white ceramic
Finishes: 03-05-08
Customized: No

Designer: BGR Industrial design
Matériel: Aluminium massif 20x12 et laiton Ø 20
Accessoires: Blanc céramique finitions: 03-05-08
Personnalisé: No

Designert: BGR Industrial design
Material: aus massivem Aluminium 20x12 aus Messing Ø 20
Zubehör: weiße Keramik
Ausführungen: 03-05-08
Kundenwunsch: Nein

Дизайн: BGR Industrial design
Материал: алюминий и латунь 20x12 Ø 20
Аксессуары: белая керамика
Отделка: 03-05-08 хром
Негабаритный: нет





LV 45



LV 11 A 05



LV 13



LV 30
LV 10



LV 05

Asta porta asciugamani
Towel rail
Porte serviettes
Handtuchhalter
полотенцедержатель
cm 62 L x 7 P x 2 H - INT. 60

- 08 - 03 - 05



LV 45

Asta porta asciugamani
Towel rail
Porte serviettes
Handtuchhalter
полотенцедержатель
cm 47 L x 7 P x 2 H - INT. 45

- 08 - 03 - 05



LV 06

Asta porta salviette
Towel rail
Porte serviettes
Handtuchhalter
Полотенцедержатель
cm 32 L x 7 P x 2 H - INT.30

- 08 - 03 - 05



LV 69 D

Asta con dosatore sapone
Towel rail with liquid soap dispenser
Porte serviettes avec dosator de savon
Handtuchring mit Seifenspender
Полотенцедержатель +
керамический дозатор
cm 35 L x 7 P x 21 H - INT. 30

- 08 - 03 - 05

- 08 A - 03 A - 05 A



LV 11 A

Porta rotolo
Paper holder
Porte roleau
Papierrollenhalter
бумагодержатель
cm 20 L x 6,5 P x 5 H

- 08 - 03 - 05



LV 11

Porta rotolo
Paper holder
Porte roleau
Papierrollenhalter
бумагодержатель
cm 2 L x 12 P x 3,5 H

- 08 - 03 - 05



LV 12 A

Porta scopino d'appoggio in ceramica
Ceramic toilet brush
Porte balayent en ceramique
Bürstengarnitur freistehend aus Keramik
Напольный керамический ёрш
cm 10 L x 10 P x 42 H

- 08 - 03 - 05



LV 039M

Porta scopino a parete
Wall mounted toilet-brush
Porte balayent à mur
Bürstengarnitur wandhängend
Настенный металлический ёрш
cm 8 L x 8 P x 45 H

- 08 - 03 - 05

03 05



LV 69

Asta con porta sapone
Towel rail with soap dish
Porte serviettes avec porte savon
Handtuchhalter mit Seifenschale
Полотенцедержатель +
керамическая мыльница
cm 37 L x 8 P x 4 H - INT. 30

- 08 - 03 - 05



LV 09

Porta sapone a parete
Wall mounted ceramic soap dish
Porte savon à mur en céramique
Seifenschale wandhängend aus Keramik
Настенный керамическая мыльница
cm 12 L x 9 P x 5 H

- 08



LV 10

Porta bicchiere a parete
Wall mounted ceramic glass holder
Porte verre à mur en céramique
Zahnbürstenhalter wandhängend aus Keramik
Настенный керамический стакан
cm 9 L x 7,5 P x 16 H

- 08



LV 30

Porta dosatore sapone liquido in ceramica
Ceramic liquid soap dispenser holder
Doseur de savon liquid en céramique
Seifenspender aus Keramik
Настенный керамический дозатор
cm 9 L x 7,5 P x 21,5 H

- 08

- 08 A



LV 09 AP

Porta sapone d'appoggio
Soap dish
Porte savon
Seifenschale
Настольная керамическая мыльница
cm 12 L x 7 P x 2 H

- 08



LV 10 AP

Bicchiere d'appoggio
Glass
Verre
Zahnputzbecher
Настольный керамический стакан
cm 9 L x 6 P x 14,5 H

- 08



LV 30 AP

Dosatore sapone liquido d'appoggio
Liquid soap dispenser
Porte savon liquid
Seifenspender
Настольный керамический дозатор
cm 9 L x 6,5 P x 19 H

- 08

- 08 A



LV 13

Porta accappatoio
Robe hook
Porte peignoir
Bodemantelhaken
Крючок
cm 2 L x 3,5 P x 3,5 H

- 08 - 03 - 05

OPZIONI E COMPLEMENTI / OPZIONI E COMPLEMENTI / OPZIONI E COMPLEMENTI / OPZIONI E COMPLEMENTI / OPZIONI E COMPLEMENTI



03



BIANCO/CROMO
White/ Chrome
Blanche / Chrome
Weiß/ Chrom
Белый матовый / хром

05



NERO/CROMO
Black/ Chrome
Noir / Chrome
Schwarz/ Chrom
черный матовый / хро

08



CROMO
Chrome
Chrome
Chrom
хром

↔ Reversibile su richiesta / Reversible on request / Réversible sur demande / Umkehrbar auf Anfrage / Реверсивный по запросу



LV 69 03

MEDEA

_GIOCHI D'AUTORE

Designer: Stilhaus
Materiale: Ottone, tubo Ø 16, basetta a muro Ø 50
Accessori: Vetro Satinato
Finitura: 08 - 10 - 16 - 18 - 23 - 24 - 36
Fuori misura: Sì
Incollo : Sì

Designer: Stilhaus
Material: Brass tube Ø 16, fixing plate cover Ø 50
Accessories: Frosted glass
Finishes: 08 - 10 - 16 - 18 - 23 - 24 - 36
Customized: Yes
By glue : Yes

Designer: Stilhaus
Matière: Laiton, tuyau Ø 16, boucle couvre-vis Ø 50
Accessoires: Verre satin
Finitions: 08 - 10 - 16 - 18 - 23 - 24 - 36
Personnalisé: Oui
Par collage : Oui

Designer: Stilhaus
Material: Messing Rohr Ø 16,
Befestigungsplatten Oberfläche Ø 50
Zubehör: Mattglas
Ausführungen: 08 - 10 - 16 - 18 - 23 - 24 - 36
Kundenwunsch: Ja
Kleber: Ja

Дизайн: Stilhaus Используемый
Материал: латунь Ø 16, Ø 50
Аксессуары: сатиновое
стеклоОтделка: 08 - 10 - 16 - 18 - 23 - 24 - 36
матовыйНегабаритный: да
Установка на клей: да

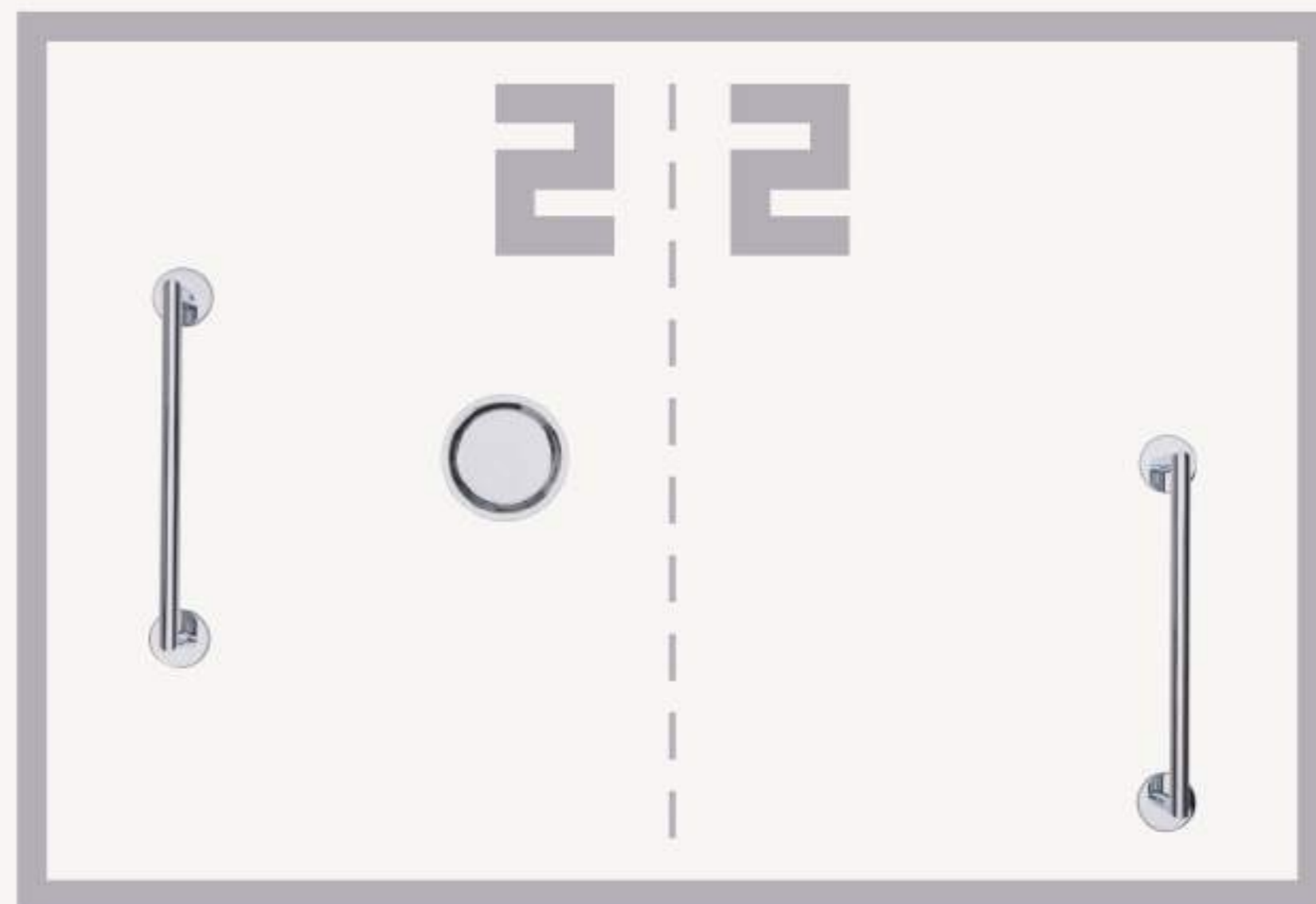

ME 06 23



ME 13 24



ME 79



ME 30
ME 10 M
ME 09 M

**ME 04**

Mensola con vetro trasparente 8 mm
Shelf with transparent glass plane
Etagère avec plan en verre transparent
Ablage aus klarem Glas
Стеклопанельная полка с ограждением- толщина 8 мм
cm 60 L x 12 P x 5 H

• 08 - 23 - 24
• 10 - 16 - 18 - 36

**ME 05**

Asta porta asciugamani
Towel rail
Porte serviette
Handtuchhalter
Полотенцедержатель
cm 61 L x 7 P x 5 H - INT. 56,50

• 08 - 23 - 24
• 10 - 16 - 18 - 36

**ME 05.2**

Porta asciugamani doppia asta
Towel rail 2 bars
Porte serviette avec 2 bar
Handtuchstange doppelt
Полотенцедержатель двойной
cm 61 L x 11 P x 5 H - INT. 56,50

• 08 - 23 - 24
• 10 - 16 - 18 - 36

**ME 45**

Asta porta asciugamani
Towel rail
Porte serviette
Handtuchhalter
Полотенцедержатель
cm 48 L x 7 P x 5 H - INT. 43,50

• 08 - 23 - 24
• 10 - 16 - 18 - 36

**ME 06**

Asta porta salviette
Towel rail
Porte serviettes
Handtuchhalter
Полотенцедержатель
cm 33 L x 7 P x 5 H - INT. 28,5

• 08 - 23 - 24
• 10 - 16 - 18 - 36

**ME 06.2**

Porta salviette doppia asta
Towel rail 2 bars
Porte serviettes avec 2 bar
Handtuchstange doppelt
Полотенцедержатель двойной
cm 33 L x 11 P x 5 H - INT. 28,50

• 08 - 23 - 24
• 10 - 16 - 18 - 36

**ME 69**

Asta porta salviette con porta sapone
Towel rail with soap dish
Porte serviettes avec porte savon
Handtuchhalter mit Seifenschale
Полотенцедержатель + стеклянная мыльница
cm 48 L x 11 P x 4,5 H - INT. 43,50

• 08 - 23 - 24
• 10 - 16 - 18 - 36

**ME 16**

Porta asciugamani a bandiera 2 aste
Towel rail with 2 adjustable bar
Porte serviettes à 2 barres orientables
Handtuchhalter schwenkbar 2 Stangen
Полотенцедержатель двойной оворотный
cm 33 L x 5 P x 9 H

• 08 - 23 - 24
• 10 - 16 - 18 - 36

**ME 07**

Anello porta salviette
Serviette holder to ring shaped
Porte serviettes à anneau
Handtuchring
Полотенцедержатель - кольцо
cm 20,5 Ø x 4,5 P x 22,5 H

• 08 - 23 - 24
• 10 - 16 - 18 - 36

**ME 79**

Anello porta salviette/dosatore
Serviette holder with metal liquid soap dispenser
Porte serviettes à anneau avec doseur
Handtuchring mit Seifenspender aus Metall
Полотенцедержатель - кольцо +
металлический дозатор
cm 23 Ø x 9 P x 29 H

• 08 - 23 - 24
• 10 - 16 - 18 - 36

**ME 09**

Porta sapone in vetro
Glass soap dish
Porte savon en verre
Seifenschale aus Glas
Настенная стеклянная мыльница
cm 12 L x 12 P x 8 H

• 08 - 23 - 24
• 10 - 16 - 18 - 36

**ME 09 M**

Porta sapone in ottone
Brass soap dish
Porte savon en laiton
Seifenschale aus Messing
Настенная металлическая мыльница
cm 12 L x 8 P x 9 H

• 08 - 23 - 24
• 10 - 16 - 18 - 36



ME 06.10



ME 11.18



ME 10
Porta bicchiere in vetro
Glass holder
Porte verre
Zahnbürstenhalter aus Glas
Настенный стеклянный стакан
cm 8 L x 11 P x 11 H

• 08 - 23 - 24
• 10 - 16 - 18 - 36



ME 10 M
Porta bicchiere in ottone
Brass glass holder
Porte verre en laiton
Zahnbürstenhalter aus Messing
Настенный металлический стакан
cm 7 L x 11 P x 11 H

• 08 - 23 - 24
• 10 - 16 - 18 - 36



ME 30
Porta dosatore sapone liquido
Brass wall-mounted liquid soap dispenser
Doseur de savon liquid en laiton
Seifenspender aus Messing
Настенный металлический дозатор
cm 5 L x 9 P x 18 H

• 08 - 23 - 24
• 10 - 16 - 18 - 36



ME 09 M AP
Porta sapone da appoggio
Leaning soap dish
Porte savon d'appui
Seifenschale freistehend
Настольная стеклянная мыльница
cm 13 Ø x 2,5 H

• 08
• 10 - 16 - 18 - 23 - 24 - 36



ME 039 M
Porta scopino in ottone a parete
Wall mounted brass toilet-brush
Porte balayent à mur en laiton
Bürstengarnitur wandhängend aus Messing
Настенный металлический ёрш
cm 8 L x 9 P x 42 H

• 08 - 23 - 24
• 10 - 16 - 18 - 36



ME 039 M INCOLLO
Porta scopino in ottone a parete da incollo
Glue wall mounted brass toilet-brush
Porte balayent à mur en laiton avec collant
Bürstengarnitur wandhängend aus Messing
Настенный металлический ёрш
cm 8 L x 9 P x 42 H

• 08 - 23 - 24
• 10 - 16 - 18 - 36



840
Kit collante e biadesivo per un articolo
Kit with bi-adhesive and glue for one article
Kit avec collant et biadhésif pour un article
Klebekit ist ein beidseitiger Klebestreifen
Клей

•

OPZIONI E COMPLEMENTI / OPZIONI E COMPLEMENTI / OPZIONI E COMPLEMENTI / OPZIONI E COMPLEMENTI

* FINITURA DISPONIBILE IN 20 GG. / Finish available in 20 days / Finition disponible en 20 jours / Oberfläche lieferbar in 20 Tagen / Отделка доступна в течение 20 дней



08

CROMO
Chrome
Chrome
Chrom
хром



10*

OTTONE LUCIDO VERNICIATO
Painted polished brass
Laiton poli peint
Lackiertes poliertes Messing
Окрашенная полированная латунь



16*

ORO
Gold
Or
Gold
Золотой



18*

ORO OPACO
Matt gold
Or mat
Mattes Gold
матовое золото



23

NERO OPACO
Matt black
Noir opaque
Matt schwarz
черный матовый



24

BIANCO OPACO
Matt white
Blanc opaque
Weiße
белый матовый



36*

NICHEL SATINATO
Satin nickel
Nickel satiné
Nickel satiniert
Никель сатин



Su richiesta si realizzano aste porta asciugamani su misura, 20 gg

Customized towel rails are available on request, 20 days
Des porte-serviettes personnalisés sont disponibles sur demande, 20 jours
Handtuchhalter sind auf Anfrage erhältlich, 20 tagen
По запросу мы можем производить полотенцедержатели под размер 20 дней



• 08-23 25 → 47 cm
• 08-23 49 → 100 cm
• 36 25 → 47 cm
• 36 49 → 100 cm



ME 11
Porta rotolo
Paper holder
Porte rouleau
Papierrollenhalter
Бумагодержатель
cm 17 L x 7 P x 4,5 H

• 08 - 23 - 24
• 10 - 16 - 18 - 36



ME 11 C
Porta rotolo coperto
Covered paper holder
Porte rouleau avec couvercle
Papierrollenhalter mit Deckel
Бумагодержатель с крышкой
cm 14 L x 12 P x 13 H

• 08 - 23 - 24
• 10 - 16 - 18 - 36



ME 11.2
Porta rotolo doppio
Double paper holder
Porte rouleau double
Papierrollenhalter doppelt
Бумагодержатель двойной
cm 26 L x 7 P x 4,5 H

• 08 - 23 - 24
• 10 - 16 - 18 - 36



ME 039
Porta scopino in ottone da appoggio
Brass toilet-brush with base
Porte balayent en laiton d'appui
Bürstengarnitur freistehend aus Messing
Напольный металлический ёрш
cm 8 Ø x 42 H

• 08 - 23 - 24
• 10 - 16 - 18 - 36

> pag. 262

> pag. 433

> pag. 336

> pag. 336

> pag. 351

> pag. 351



MIZAR

_LES JEUX SONT FAITS

Designer: Stilhaus
Materiale: Piatto ottone 15 x 4
Accessori: ceramica bianca
Finiture: 08 - 23
Fuori misura: no

Designer: Stilhaus
Material: Solid Brass 15x4
Accessories: white ceramic
Finishes: 08 - 23
Customized: no

Designer: Stilhaus
Matériel: Laiton massif 15x4
Accessoires: blanc céramique
Finitions: 08 - 23
Personnalisé: No

Designer: Stilhaus
Material: Messing bar 15 x 4
Zubehör: weiße Keramik
Ausführungen: 08 - 23
Kundenwunsch: Nein

Дизайн: Stil Haus
Материал: латунь
Аксессуары: белая керамика
Покрытие: 08 - 23
Негабаритный: нет





MZ 09
MZ 10
MZ 30



MZ 05 23



MZ 69



MZ 11 23



MZ 04

Mensola plexiglass
Shelf
Etagère
Ablage
Полка из оргстекла
cm 60 L x 11 P x 5 H - INT. 59

• 08 - 23



MZ 05

Asta porta asciugamani
Towel rail
Porte serviettes
Handtuchhalter
Полотенцедержатель
cm 58 L x 8,5 P x 1,5 H - INT. 53

• 08 - 23



MZ 45

Asta porta asciugamani
Towel rail
Porte serviettes
Handtuchhalter
Полотенцедержатель
cm 45 L x 8 P x 1,5 H - INT. 39

• 08 - 23



MZ 06

Asta porta salviette
Towel rail
Porte serviettes
Handtuchhalter
Полотенцедержатель
cm 28,5 L x 8 P x 1,5 H - INT. 22,5

• 08 - 23



MZ 11

Porta rotolo
Peper holder
Porte rouleau
Papierrollenhalter
Бумагодержатель
cm 17 L x 8 P x 1,5 H

• 08 - 23



MZ 11C

Porta rotolo con coperchio
Covered paper holder
Porte rouleau avec couvercle
Papierrollenhalter mit Deckel
Бумагодержатель закрытый
cm 17 L x 9 P x 10 H

• 08 - 23



MZ 039

Porta scopino da appoggio
Toilet-brush with base
Porte balayent d'appui
Bürstengarnitur freistehend
Напольный металлический ёрш
cm Ø 8 x 44 H

• 08 - 23



MZ 039 M

Porta scopino a parete
Wall-mounted toilet-brush
Porte balayent à mur
Bürstengarnitur oval wandhängend
Настенный металлический ёрш
cm Ø 8 x 44 H

• 08 - 23



MZ 06.1

Asta porta salviette
Towel rail
Porte serviettes
Handtuchhalter
Полотенцедержатель
cm 27 L x 8 P x 1,5 H

• 08 - 23

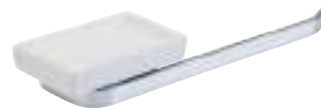

MZ 69

Porta salviette con porta sapone
Serviettes holder with soap dish
Porte serviettes avec porte savon
Handtuchhalter mit Seifenschale
Полотенцедержатель + керамическая
мыльница
cm 29 L x 8 P x 4 H

• 08 - 23



MZ 69 D

Porta salviette con dosatore sapone
Serviettes holder with soap dispenser
Porte serviettes avec doseur de savon
Handtuchhalter mit Seifenspender
Полотенцедержатель + керамический дозатор
cm 27 L x 8 P x 18 H

• 08 - 23



MZ 09

Porta sapone a parete
Wall mounted ceramic soap dish
Porte savon à mur en céramique
Seifenschale wandhängend aus Keramik
Настенная керамическая мыльница
cm 11,5 L x 7 P x 4 H

• 08 - 23



1076

Mensola plexiglass con asta porta asciugamani
Shelf with towel rail
Entragerè avec porte serviettes
Ablage mit Handtuchhalter
Полка из оргстекла с полотенцедержателем
cm 26 L x 11 P x 13 H - INT. 24,5

• 08 - 23



1077

Mensola plexiglass con asta porta asciugamani
Shelf with towel rail
Entragerè avec porte serviettes
Ablage mit Handtuchhalter
Полка из оргстекла с полотенцедержателем
cm 40 L x 11 P x 13 H - INT. 28,5

• 08 - 23



OPZIONI E COMPLEMENTI / OPZIONI E COMPLEMENTI OPZIONI E COMPLEMENTI / OPZIONI E COMPLEMENTI / OPZIONI E COMPLEMENTI



MZ 10

Porta bicchiere a parete
Wall mounted ceramic glass holder
Porte verre à mur en céramique
Zahnbürstenhalter wandhängend aus Keramik
Настенный керамический стакан
cm 8 L x 8 P x 12 H

• 08 - 23



MZ 30

Porta dosatore sapone liquido in ceramica
Ceramic liquid soap dispenser holder
Doseur de savon liquid en céramique
Seifenspender aus Keramik
Настенный керамический дозатор
cm 8 L x 8 P x 18 H

• 08 - 23



MZ 14

Porta sapone con Porta bicchiere
Soap dish + Glass holder
Porte savon + Porte verre
Seifenschale + Zahnbürstenhalter freistehend
Настольные керамический
cm 16 L x 8 P x 18 H

• 08 - 23



MZ 13.2

Porta accappatoio (2 ganci)
Robe hook (2 hooks)
Porte peignoir (2 crochets)
Bademantelhaken (2 Haken)
Крючок
cm 2 L x 3,5 P x 9 H

• 08 - 23



08

CROMO
Chrome
Chrome
Chrom
хром



23

NERO OPACO
Matt black
Noir opaque
Matt schwarz
черный матовый

↔ Reversibile su richiesta
Reversible on request / Réversible sur demande / Umkehrbar auf Anfrage / Реверсивный по запросу

+



> pag. 268



> pag. 303



> pag. 411



> pag. 411



> pag. 410



> pag. 410



> pag. 410

RAIL

_PANTA REI

Designer: Giovanna Talocci, Marco Pallocca
Materiale: Ottone
Accessori: Ocritech, Multistrato marino, Marmo bianco, Vetro
Finiture: 08, 10, 23, 36
Personalizzazione: Sì

Designer: Giovanna Talocci, Marco Pallocca
Material: Solid Brass
Accessories: Ocritech, Wood, White marble, Glass
Finishes: 08, 10, 23, 36
Customized: Yes

Designer: Giovanna Talocci, Marco Pallocca
Matériel: Laiton massif
Accessoires: Ocritech, Bois, Marbre blanc, Verre
Finitions: 08, 10, 23, 36
Personnalisé: Oui

Designer: Giovanna Talocci, Marco Pallocca
Material: Messing bar
Zubehör: Ocritech, Holz, Weißer Marmor, Glas
Ausführungen: 08, 10, 23, 36
Kundenwunsch: Ja

Дизайн: Giovanna Talocci, Marco Pallocca
Материал: латунь
Аксессуары: Окритек, морская фанера, белый мрамор, стекло.
Покрытие: 08, 10, 23, 36
Негабаритный: да







08 - OCRITECH



23 - MULTISTRATO MARINO



10 - MARMO



36 - MARMO



SOL 1



SOL 2



SOL 3



SOL 4



SOL 5



SOL 6



SOL 7



SOL 8



SOL 9



SOL 10

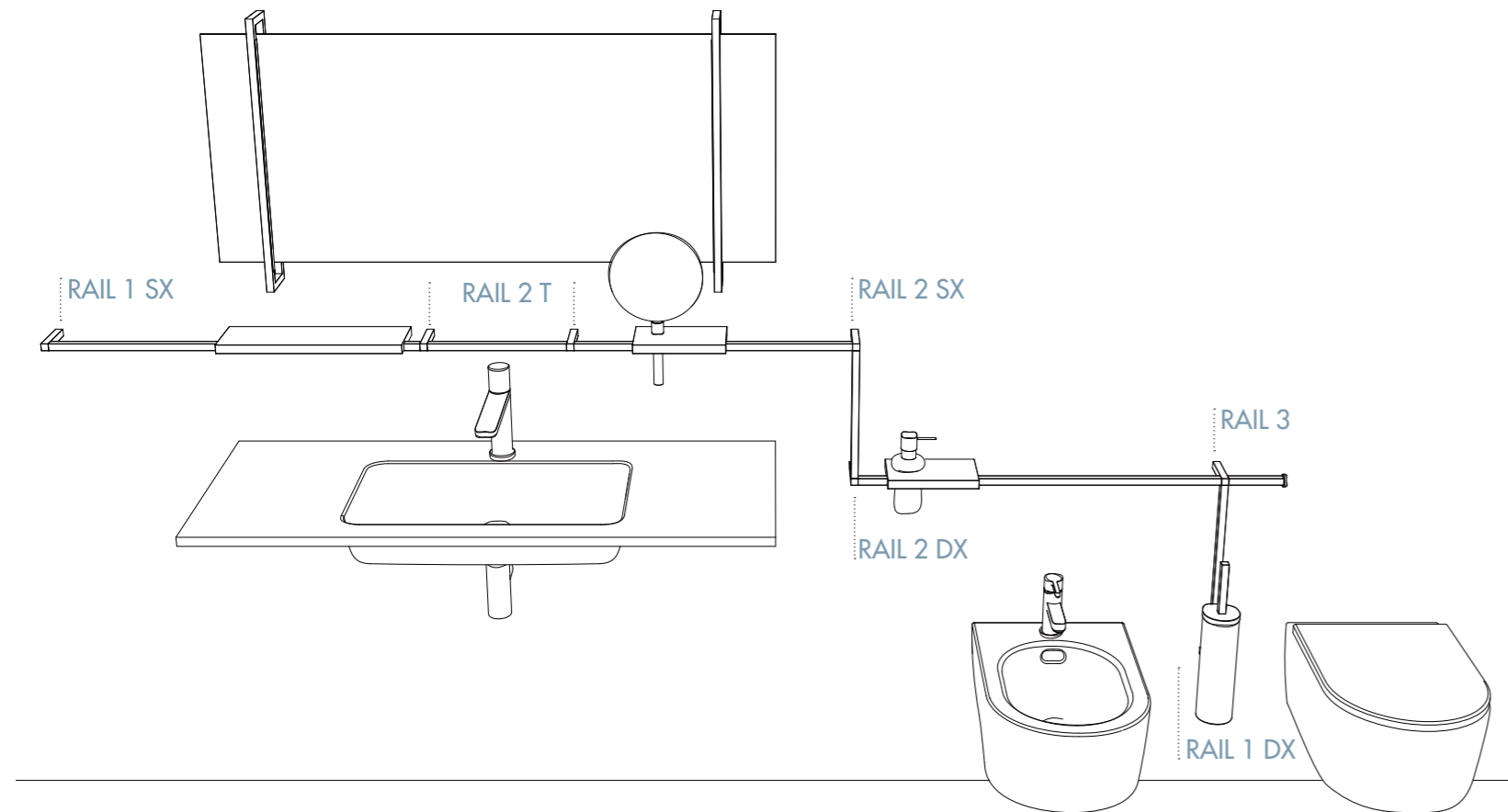

ESEMPIO
EXAMPLE
EXEMPLE
BEISPIEL
Пример



RAIL 1 DX
RAIL 1 SX
RAIL 05
RAIL 20.1 OCRITECH
RAIL 037 08
TOT

RL 08

Asta cm 80
Rod cm 80
Canne cm 80
Stange cm 80
Вал см 80
cm 80 L

• 08 - 23
• 36 - 10

RL 05

Asta cm 60
Rod cm 60
Canne cm 60
Stange cm 60
Вал см 60
cm 60 L

• 08 - 23
• 36 - 10

RL 45

Asta cm 45
Rod cm 45
Canne cm 45
Stange cm 45
Вал см 45
cm 45 L

• 08 - 23
• 36 - 10

RL 06

Asta cm 30
Rod cm 30
Canne cm 30
Stange cm 30
Вал см 30
cm 30 L

• 08 - 23
• 36 - 10

RL 11

Asta cm 12, anche per rotolo in linea
Rod cm 12, also for in-line roll
Canne cm 12, également pour les rouleaux en ligne
Stange cm 12, auch für Inline-Rolle
Вал см 12, также для линейного рулона
cm 12 L

• 08 - 23
• 36 - 10

RL 039 M

Porta scopino a parete
Wall mounted toilet-brush
Porte balaynet à mur
Bürstengarnitur wandhängend
Настенный металлический ёрш
cm 8 L x 8 P x 60 H

• 08 - 23
• 36 - 10

RAIL 1

Supporto 1 via destro o sinistro
Support 1 way right or left
Support 1 voie droite ou gauche
Unterstützung 1 Weg rechts oder links
Поддержка 1 путь направо или налево
cm 1,6

• 08 - 23
• 36 - 10

RAIL 2

Supporto 2 vie
2-way support
Soutien à double sens
2-Wege-Unterstützung
двусторонняя поддержка
cm 1,6

• 08 - 23
• 36 - 10

RAIL 2.T

Supporto 2 vie a T
T-shaped 2-way support
Support bidirectionnel en forme de T
T-förmige 2-Wege-Stütze
T-образная 2-х сторонняя опора
cm 1,6

• 08 - 23
• 36 - 10

RAIL 3

Supporto 3 vie
3-way support
Soutien à trois voies
3-Wege-Unterstützung
3-сторонняя поддержка
cm 1,6

• 08 - 23
• 36 - 10

RAIL 4

Supporto 2 vie ad angolo
2-way corner support
Support d'angle à 2 voies
2-Wege-Eckstütze
Двусторонняя угловая опора
cm 1,6

• 08 - 23
• 36 - 10



CONFIGURA LA TUA RAIL CON LA NOSTRA APP

Configure your Rail with our App
Configurez votre Rail avec notre application
Konfigurieren sie ihr Rail mit unserer App
Настройте свой Rail с нашим APP



**RL 20**

Mensola cm 20
Shelf
Étagère
Ablage
Полка см 20
cm 20 L x 12 P

- Legno - Ocritech
- Marmo bianco

**RL 20.1**

Mensola cm 20 con 1 foro
Shelf with 1 hole
Étagère avec 1 trou
Ablage mit 1 loch
Полка 20 см с 1 отверстием
cm 20 L x 12 P

- Legno - Ocritech
- Marmo bianco

**RL 20.2**

Mensola cm 20 con 2 fori
Shelf with 2 hole
Étagère avec 2 trous
Ablage mit 2 loch
Полка 20 см с 2 отверстиями
cm 20 L x 12 P

- Legno - Ocritech
- Marmo bianco

**RL 20.3**

Mensola cm 20 con 1 foro specchio
Shelf with 1 hole for mirror
Étagère avec 1 trou pour miroir
Ablage mit 1 loch für spiegel
Полка 20 см с 1 зеркальным отверстием
cm 20 L x 12 P

- Legno - Ocritech
- Marmo bianco

**RL 01.70**

Specchio rettangolare filo lucido reversibile
Reversible rectangular mirror with shine edge
Miroir rectangulaire avec bord brillant réversible
Rechteckiger Spiegel mit glänzendem Rand
Прямоугольное зеркало с реверсивной полированной проволокой
cm 55 x 70

**RL 01.90**

Specchio rettangolare filo lucido reversibile
Reversible rectangular mirror with shine edge
Miroir rectangulaire avec bord brillant réversible
Rechteckiger Spiegel mit glänzendem Rand
Прямоугольное зеркало с реверсивной полированной проволокой
cm 55 x 90

**RL 01.120**

Specchio rettangolare filo lucido reversibile
Reversible rectangular mirror with shine edge
Miroir rectangulaire avec bord brillant réversible
Rechteckiger Spiegel mit glänzendem Rand
Прямоугольное зеркало с реверсивной полированной проволокой
cm 55 x 120

**RL 01.140**

Specchio rettangolare filo lucido reversibile
Reversible rectangular mirror with shine edge
Miroir rectangulaire avec bord brillant réversible
Rechteckiger Spiegel mit glänzendem Rand
Прямоугольное зеркало с реверсивной полированной проволокой
cm 55 x 140

**RL 40**

Mensola cm 40
Shelf
Étagère
Ablage
Полка см 40
cm 40 L x 12 P

- Legno - Ocritech
- Marmo bianco

**RL 40.1**

Mensola cm 40 con 1 foro
Shelf with 1 hole
Étagère avec 1 trou
Ablage mit 1 loch
Полка 40 см с 1 отверстием
cm 40 L x 12 P

- Legno - Ocritech
- Marmo bianco

**RL 40.2**

Mensola cm 40 con 2 fori
Shelf with 2 hole
Étagère avec 2 trous
Ablage mit 2 loch
Полка 40 см с 2 на 1
cm 40 L x 12 P

- Legno - Ocritech
- Marmo bianco

**RL 40.3**

Mensola cm 40 con 1 foro specchio
Shelf with 1 hole for mirror
Étagère avec 1 trou pour miroir
Ablage mit 1 loch für spiegel
Полка 40 см с 1 зеркальным отверстием
cm 40 L x 12 P

- Legno - Ocritech
- Marmo bianco

**RL 03**

Appliche per specchio a led
Led mirror lamp
Lampe a Led pour miroir
LED Leuchte für Spiegel
Настенный светильник для светодиодного зеркала
cm 60 L x 10 P x 4 H
CE : V 220 IP23 LED 7,5W a 12 Vdc 4000K

- 08 - 10 - 23
- 36

**RL 488**

Specchio ingranditore 3x portatile
Portable 3x magnifying mirror
Miroir grossissant portable 3x
Tragbarer Spiegel mit 3-facher Vergrößerung
Портативное 3-кратное увеличительное зеркало
Cm Ø 20

- 08 - 09 - 23
- 36

**RL 28.70**

Piano con lavabo integrato in ocritech
Ocritech top with washbasin
Plan en ocritech avec lavabo
Platte mit integriertem Ocritech-Waschbecken
Топ со встроенным умывальником Ocritech
cm 70 L x 50 P

- 01

**RL 28.90**

Piano con lavabo integrato in ocritech
Ocritech top with washbasin
Plan en ocritech avec lavabo
Platte mit integriertem Ocritech-Waschbecken
Топ со встроенным умывальником Ocritech
cm 90 L x 50 P

- 01

**RL 60**

Mensola cm 12 porta smartphone
Phone holder shelf
Étagère avec support de téléphone
Ablage telefonhalter
Полка 12 см держатель для смартфона
cm 15 L x 12 P

- Legno - Ocritech
- Marmo bianco

**RL 040.08**

Bicchieri in vetro
Glass holder
Porte verre
Zahnbürstenhalter aus Glas
Стеклянное стекло
cm 6 L x 6 P x 11 H

€ 27,00

**RL 037.08**

Dosatore sapone liquido in vetro con
pompetta metallo
Glass liquid soap dispenser with chrome pomp
Doseur de savon liquid en verre avec pompe
Seifenspender aus Glas
Стеклянный дозатор
cm 8 L x 8 P x 13 H

- 08 - 10 - 23
- 36

**RL 28.120**

Piano con lavabo integrato in ocritech
Ocritech top with washbasin
Plan en ocritech avec lavabo
Platte mit integriertem Ocritech-Waschbecken
Топ со встроенным умывальником Ocritech
cm 120 L x 50 P

- 01

**RL 29.70**

Struttura porta lavabo in ottone
Top brass support
Support en lation for plan
Waschtischhalterung aus Messing
Латунная конструкция держателя умывальника
cm 70 L x 50 P x 83 H

- 08 - 10 - 23
- 36

**RL 29.90**

Struttura porta lavabo in ottone
Top brass support
Support en lation for plan
Waschtischhalterung aus Messing
Латунная конструкция держателя умывальника
cm 90 L x 50 P x 83 H

- 08 - 10 - 23
- 36

**RL 29.120**

Struttura porta lavabo in ottone
Top brass support
Support en lation for plan
Waschtischhalterung aus Messing
Латунная конструкция держателя умывальника
cm 120 L x 50 P x 83 H

- 08 - 10 - 23
- 36

GUIDA AL CONFIGURATORE RAIL

GUIDE TO RAIL CONFIGURATOR / GUIDE DU CONFIGURATEUR DE RAIL / ANLEITUNG ZU RAIL CONFIGURATOR / РУКОВОДСТВО ПО RAIL CONFIGURATOR



stilhaus

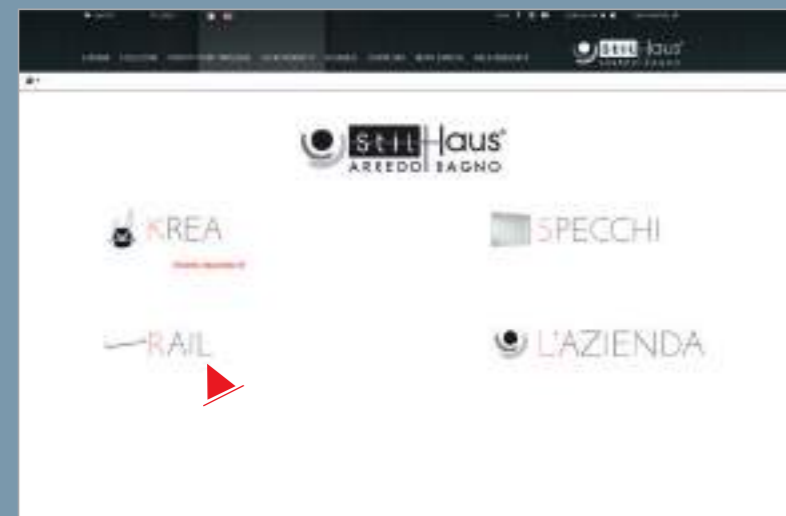

Entra nel configuratore, scegli la proposta e clicca su Rail e segui le richieste.

Enter the configurator, click on rail and you can start creating your own 3d composition starting from an empty wall.

Entrez dans le configurateur, choisissez votre proposition, cliquez sur Rail et suivez les instructions.

Einstieg in den Konfigurator, Wählen Sie Ihren Vorschlag, Klicken Sie auf Rail und folgen Sie den Anweisungen.

Войдите в конфигуратор, Выберите свое предложение, Нажмите на Rail и следуйте требованиям.

Seleziona i componenti.

Select the components on the left side of the screen.

Sélectionnez les composants.

Komponenten auswählen.

Выберите компоненты.



Crea composizioni ruotando le aste.

To design your composition you can rotate every components by the selected button.

Créez des compositions en faisant tourner les tiges.

Erstellen Sie Kompositionen, indem Sie die Stäbe drehen.

Создавайте композиции, вращая стержни.



Scegli le finiture.

Choose the best finish you want for your composition.

Choisissez vos finitions.

Wählen Sie Ihre Oberflächen aus.

Выберите отделку.

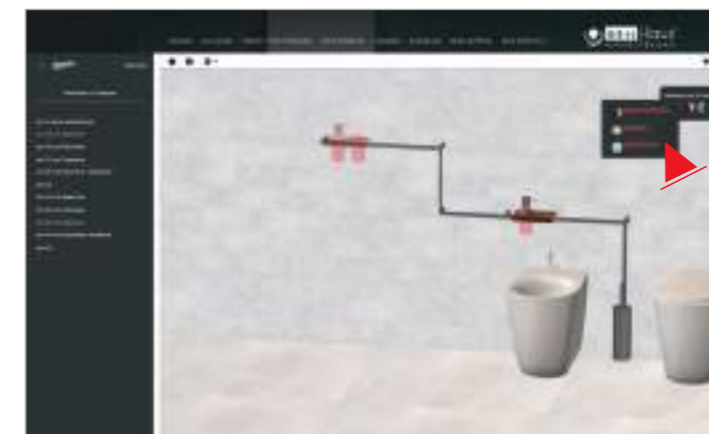

Crea barre continue sovrapponendo gli attacchi.

Place the selected items on the wall, creating your design. you can also overlap

Crée des barres continues en superposant les attaches.

Erzeugt durchgehende Balken durch überlappende Anhänge.

Создает непрерывные полосы путем наложения насадок друг на друга.

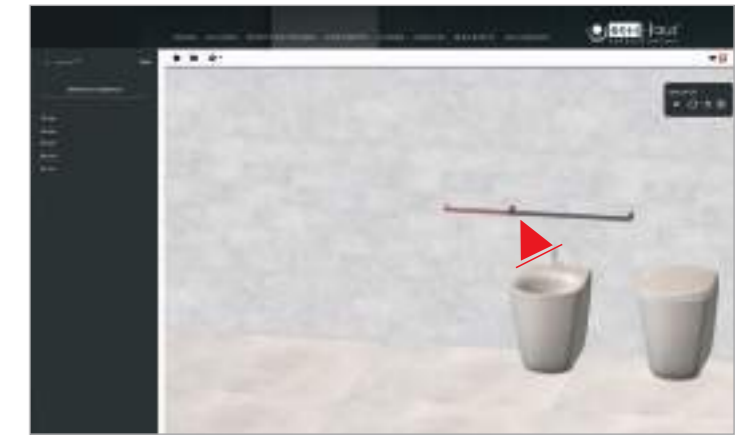

Inserisci le mensole.

Put on the composition the shelves with accessories you need.

Insérer des étagères.

Einlegeböden.

Вставьте полки.

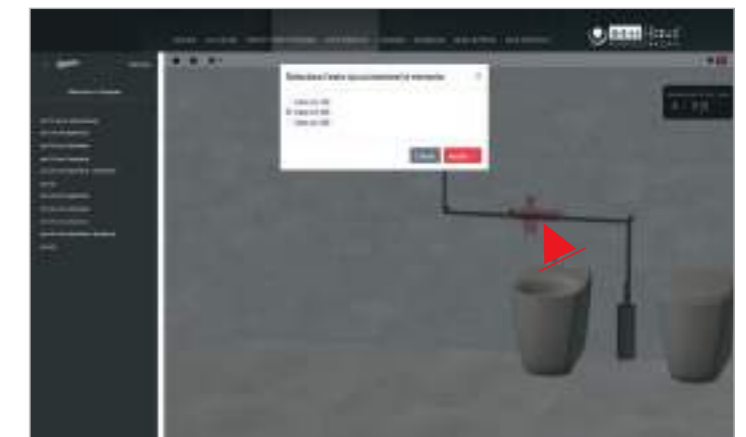

Apri il carrello e procedi all'ordine

Go to the cart and proceed with order or quotation

Ouvrir le panier d'achat et procéder à la commande

Öffnen Sie den Warenkorb und fahren Sie mit der Bestellung fort

Откройте корзину и перейдите к оформлению заказа



**RL 08 C**

Asta cm 80
80 cm rod
tige de 80 cm
80 cm Stange
стержень 80 см
cm 83,2 L x 9,5 P x 1,5 H

• 08 - 10 - 23
• 36

RL 05 C

Asta cm 60
60 cm rod
tige de 60 cm
60 cm Stange
стержень 60 см
cm 63,2 L x 9,5 P x 1,5 H

• 08 - 10 - 23
• 36

RL 45 C

Asta cm 45
45 cm rod
tige de 45 cm
45 cm Stange
стержень 45 см
cm 48,2 L x 9,5 P x 1,5 H

• 08 - 10 - 23
• 36

RL 06 C

Asta cm 30
30 cm rod
tige de 30 cm
30 cm Stange
стержень 30 см
cm 33,2 L x 9,5 P x 1,5 H

• 08 - 10 - 23
• 36

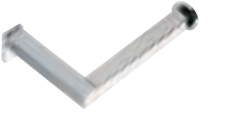
**RL 72**

Asta cm 60 con dosatore e rotolo
60 cm rod with dispenser and roll
tige de 60 cm avec distributeur et rouleau
60 cm langer Stab mit Spender und Rolle
Штанга 60 см с дозатором и валиком
cm 75,7 L x 12 P x 13 H

• 08 - 10 - 23
• 36
• Legno - Ocritech
• Marmo bianco

RL 73

Asta cm 30 con rotolo
30 cm shaft with rotolo
Arbre de 30 cm avec rotolo
30 cm langer Schaft mit Rotolo
30 cm langer Schaft mit Rotolo
cm 48,2 L x 9,5 P x 1,5 H

• 08 - 10 - 23
• 36

RL 13

Porta accappatoio
Robe hook
Porte peignoir
Bademantelhaken
Крючок
cm 2,8 L x 4,5 P x 2,8 H

• 08 - 23
• 36 - 10

RL 11.T

Porta rotolo singolo
Single roll holder
Porte-rouleau unique
Einzelner Rollenhalter
Одноместный держатель рулона
cm 14,3 L x 9,5 P x 5 H

• 08 - 23
• 36 - 10

**RL 69**

Asta cm 60 con dosatore
60 cm rod with dispenser
tige de 60 cm avec distributeur
60 cm langer Stab mit Spender
Штанга 60 см с дозатором
cm 63,2 L x 12 P x 13 H

• 08 - 10 - 23
• 36
• Legno - Ocritech
• Marmo bianco

RL 70

Asta cm 60 con bicchiere
Rod cm 60 with glass
Tige cm 60 avec verre
Stab cm 60 mit Glas
Стержень см 60 со стеклом
cm 63,2 L x 12 P x 11 H

• 08 - 10 - 23
• 36
• Legno - Ocritech
• Marmo bianco

RL 71

Asta cm 60 con dosatore e bicchiere
60 cm rod with dispenser and glass
tige de 60 cm avec distributeur et verre
60 cm langer Stab mit Spender und Glas
Штанга 60 см с дозатором и стаканом
cm 63,2 L x 12 P x 13 H

• 08 - 10 - 23
• 36
• Legno - Ocritech
• Marmo bianco

RL 04

Asta cm 60 con mensola
60 cm shaft with handle
manche de 60 cm avec poignée
60 cm Stiel mit Griff
Вал 60 см с ручкой
cm 63,2 L x 12 P x 2 H

• 08 - 10 - 23
• 36
• Legno - Ocritech
• Marmo bianco

**RL 75**

Porta scopino con rotolo
Toilet brush holder with roll
Porte-brosse de toilette avec rouleau
Klobbürstenhalter mit Rolle
Держатель туалетной щетки с валиком
cm 15 L x 17,5 P x 80 H

• 08 - 10 - 23
• 36

RL 039

Porta scopino da appoggio
Toilet-brush with base
Porte balayent d'appui
Bürstengarnitur freistehend
Напольный металлический ёрш
cm 8 L x 8 P x 40 H

• 08 - 10 - 23
• 36

**RL 10**

Asta cm 22 con bicchiere
Rod cm 22 with glass
Tige cm 22 avec verre
Stab cm 22 mit Glas
Стержень см 22 со стеклом
cm 25,2 L x 12 P x 11 H

• 08 - 10 - 23
• 36
• Legno - Ocritech
• Marmo bianco

RL 14

Asta cm 22 con dosatore e bicchiere
22 cm rod with dispenser and glass
tige de 22 cm avec distributeur et verre
22 cm langer Stab mit Spender und Glas
Штанга 22 см с дозатором и стаканом
cm 25,2 L x 12 P x 13 H

• 08 - 10 - 23
• 36
• Legno - Ocritech
• Marmo bianco

RL 30

Asta cm 22 con dosatore
22 cm rod with dispenser
tige de 22 cm avec distributeur
22 cm langer Stab mit Spender
Штанга 2 см с дозатором
cm 25,2 L x 12 P x 13 H

• 08 - 10 - 23
• 36
• Legno - Ocritech
• Marmo bianco

RL 74

Asta cm 22 con mensola
22 cm shaft with handle
manche de 22 cm avec poignée
22 cm Stiel mit Griff
Вал 22 см с ручкой
cm 25,2 L x 12 P x 2 H

• 08 - 10 - 23
• 36
• Legno - Ocritech
• Marmo bianco



SOL 1 cm 248 L

- 08 - 10 - 23
- 36
- Legno / Ocritech
- Marmo Bianco



SOL 2 cm 78 L

- 08 - 10 - 23
- 36
- Legno / Ocritech
- Marmo Bianco



SOL 3 cm 18 L x 80 H

- 08 - 10 - 23
- 36



SOL 4 cm 46 L x 80 H

- 08 - 10 - 23
- 36



SOL 5 cm 76 L x 80 H

- 08 - 10 - 23
- 36
- Legno / Ocritech
- Marmo Bianco



SOL 6 - RAIL 4 cm 72 x 72

- 08 - 10 - 23
- 36
- Legno / Ocritech
- Marmo Bianco



SOL 7 cm 84 L

- 08 - 10 - 23 €
- 36 €
- Legno / Ocritech €
- Marmo Bianco €



SOL 8 cm 84 L

- 08 - 10 - 23 €
- 36 €
- Legno / Ocritech €
- Marmo Bianco €



SOL 9 cm 84 L

- 08 - 10 - 23 €
- 36 €
- Legno / Ocritech €
- Marmo Bianco €



SOL 10 cm 126 L x 16 H

- 08 - 10 - 23 €
- 36 €
- Legno / Ocritech €
- Marmo Bianco €



OPZIONI E COMPLEMENTI / OPZIONI E COMPLEMENTI / OPZIONI E COMPLEMENTI / OPZIONI E COMPLEMENTI

* FINITURA DISPONIBILE IN 20 GG. / Finish available in 20 days / Finition disponible en 20 jours / Oberfläche lieferbar in 20 Tagen / Отделка доступна в течение 20 дней



08



CROMO
Chrome
Chrome
Chrom
хром

10



OTTONE LUCIDO
Polished brass
Laiton poli
Messing poliert
Полированная латунь

23



NERO OPACO
Matt black
Noir opaque
Mattschwarz
черный матовый

36*



NICHEL SATINATO
Satin nickel
Nickel satiné
Nickel satiniert
Никель сатин



MULTISTRATO MARINO

Marine playwood
Contreplaque marine
Marinesperrholz
многослойный морской



OCRITECH

Ocritech
Ocritech
Ocritech
Ocritech



MARMO BIANCO

Marble
Marbre
Marmor
Белый мрамор

SATURNO

_PROSPETTIVA NATURALE

Designer: Stilhaus
Materiale: Barra Inox 304,
Accessori: vetro satinato
Finitura: 54
Fuori misura: si

Designer: Stilhaus
Material: Barra Inox 304
Accessories: Frosted Glass
Finishes: 54
Customized: si

Designer: Stilhaus
Matériau: Bar d'acier 304
Accessoires: Verre satin
Finitions: 54
Personnalisé: Si

Designer: Stilhaus
Material: Stahl Bar 304
Zubehör: Milchglas
Ausführungen: 54
Kundenwunsch: Ja

Дизайн: Stil Haus
Материал: нержавеющая сталь
Аксессуары: сатинированное стекло
Покрытие: 54 сатинированная сталь
Негабаритный: да





ST 10
ST 30



ST 45



ST 11



ST 13



ST 04

Mensola con plexiglass satinato
Shelf
Étagère
Ablage
Полка из оргстекла
cm 60 L x 11 P x 2 H

- 54

ST 05 

Asta porta asciugamani
Towel rail
Porte serviettes
Handtuchhalter
Полотенцедержатель
cm 58 L x 7 P x 1,5 H - INT. 58

- 54

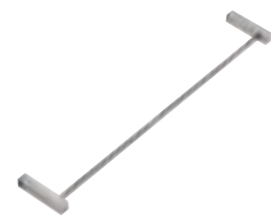

ST 45

Asta porta asciugamani
Towel rail
Porte serviettes
Handtuchhalter
Полотенцедержатель
cm 45 L x 7 P x 1,5 H - INT. 43

- 54



ST 06

Asta porta salviette
Towel rail
Porte serviettes
Handtuchhalter
Полотенцедержатель
cm 32 L x 7 P x 1,5 H - INT. 28

- 54



ST 039 M

Porta scopino a parete
Wall mounted toilet-brush
Porte balayent à mur
Bürstengarnitur wandhängend
Настенный металлический ёрш
cm ø 8 x 38 H

- 54



ST 17

Mensola con plexiglass satinato
Shelf
Étagère
Ablage
Полка из оргстекла
cm 32 L x 11 P x 2 H

- 54



ST 16

Porta asciugamani snodo 2 aste
Towel rail with 2 adjustable bar
Porte serviettes à 2 barres orientables
Handtuchhalter schwenkbar 2 Stangen
Полотенцедержатель двойной поворотный
cm 3 L x 33 P x 8 H

- 54



ST 09

Porta sapone a parete
Wall mounted ceramic soap dish
Porte savon à mur en céramique
Seifenschale wandhängend aus Keramik
Настенная керамическая мыльница
cm 10,5 L x 10,5 P x 4,5 H

- 54



ST 10

Porta bicchiere a parete
Wall mounted ceramic glass holder
Porte verre à mur en céramique
Zahnbürstenhalter wandhängend aus Keramik
Настенный керамический стакан
cm 7 L x 9,5 P x 11,5 H

- 54



ST 30

Dosatore sapone liquido a parete
Wall-mounted soap dispenser
Doseur de savon
Seifenspender
Настенный стеклянный дозатор
cm 7 L x 10 P x 20 H

- 54

OPZIONI E COMPLEMENTI / OPZIONI E COMPLEMENTI OPZIONI E COMPLEMENTI / OPZIONI E COMPLEMENTI / OPZIONI E COMPLEMENTI

 Reversibile su richiesta / Reversible on request / Réversible sur demande / Umkehrbar auf Anfrage / Реверсивный по запросу

 Su richiesta si realizzano aste porta asciugamani su misura, 5 gg

Customized towel rails are available on request, 5 days
Des porte-serviettes personnalisés sont disponibles sur demande, 5 jours
Handtuchhalter sind auf Anfrage erhältlich, 5 tagen
По запросу мы можем производить полотенцедержатели под размер 5 дней



- 54 25 → 44 cm
- 54 46 → 80 cm



ST 13

Porta accappatoio
Robe hook
Porte peignoir
Bademantelhaken
Крючок
cm 1,5 L x 3,5 P x 2,5 H

- 54

ST 11 

Porta rotolo
Paper holder
Porte rouleau
Papierrollenhalter
Бумагодержатель
cm 16 L x 7 P x 4 H

- 54

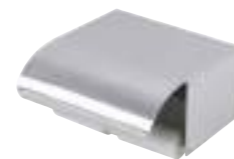

1005

Porta rotolo con coperchio
Covered paper holder
Porte rouleau avec couvercle
Papierrollenhalter mit Deckel
Бумагодержатель с крышкой
cm 12 L x 13 P x 6 H

- 54



ST 039

Porta scopino da appoggio
Ceramic toilet-brush with base
Porte balayent en céramique d'appui
Bürstengarnitur freistehend
Напольный металлический ёрш
cm ø 8 x 38 H

- 54



ST 17

TOTEM

_ARMONIE ROBUSTE

Designer: Massimiliano Settimelli
Materiale: Ottone
Accessori: Ocritech, Plexiglass trasparente
Finitura: 08 - 03 - 05 - 36
Fuori misura: Sì
Certificazione: UNI EN 11064/2019

Designer: Massimiliano Settimelli
Material: Brass
Accessories: Ocritech, Plexiglas transparent
Finishes: 08 - 03 - 05 - 36
Customized: Yes
Certification: UNI EN 11064/2019

Designer: Massimiliano Settimelli
Matériel: Laiton
Accessoires: céramique
Finitions: 08 - 03 - 05 - 36
Personnalisé: Oui
Certification : UNI EN 11064/2019

Designer: Massimiliano Settimelli
Material: Messing
Zubehör: Ocritech, klares Plexiglas
Ausführungen: 08 - 03 - 05 - 36
Kundenwunsch: Ja
Zertifizierung: UNI EN 11064/2019

Дизайн: Massimiliano Settimelli
Материал: латунь
Аксессуары: Окритеч, прозрачное оргстекло
Отделка: 08 - 03 - 05 - 36
Негабаритный: да
Сертификация: UNI EN 11064/2019





TT 03 08
 TT 15
 TT1205+TT1206



TT 1206
 TT 14
 TT 02



TT 11



TT 01



TT 01

Maniglione di sicurezza in ottone cm 30
Brass safety handle cm 30
Poignée de sécurité en laiton cm 30
Sicherheitsgriff aus Messing cm 30
Латунная предохранительная ручка см 30
cm 35,5 L x 8 P x 3 H

• 08 - 03 - 05
• 36



TT 02

Maniglione di sicurezza in ottone cm 45
Brass safety handle cm 45
Poignée de sécurité en laiton cm 45
Sicherheitsgriff aus Messing cm 45
Латунная предохранительная ручка см 45
cm 45,5 L x 8 P x 3 H

• 08 - 03 - 05
• 36



TT 03

Maniglione di sicurezza in ottone cm 60
Brass safety handle cm 60
Poignée de sécurité en laiton cm 60
Sicherheitsgriff aus Messing cm 60
Латунная предохранительная ручка см 60
cm 60,5 L x 8 P x 3 H

• 08 - 03 - 05
• 36



TT 04

Maniglione di sicurezza in ottone cm 80
Brass safety handle cm 80
Poignée de sécurité en laiton cm 80
Sicherheitsgriff aus Messing cm 80
Латунная предохранительная ручка см 80
cm 80,5 L x 8 P x 3 H

• 08 - 03 - 05
• 36



TT 09

Maniglione di sicurezza in ottone cm 120
Brass safety handle cm 120
Poignée de sécurité en laiton cm 120
Sicherheitsgriff aus Messing cm 120
Латунная предохранительная ручка см 120
cm 120,9 L x 8,5 P x 3 H

• 08 - 03 - 05
• 36



TT 12

Vaschetta plexiglass per barra orizzontale
Plexiglas tray for horizontal bar
Plateau en plexiglas pour barre horizontale
Plexiglasschale für horizontale Stange
Лоток из оргстекла для горизонтальной полосы
cm 25 L x 14 P x 12 H



TT 14

Mensola 1 foro plexiglass per barra orizzontale
Plexiglass shelf 1 hole for horizontal bar
Étagère en plexiglas 1 trou pour barre horizontale
Plexiglasboden 1 Loch für Reckstange
Полка из оргстекла 1 отверстие для горизонтальной штанги
cm 10 L x 14 P x 6 H



TT 15

Mensola 2 fori plexiglass per barra orizzontale
2-hole plexiglass shelf for horizontal bar
Tablette en plexiglas à 2 trous pour barre horizontale
2-Loch-Plexiglasablage für Reckstange
Полка из оргстекла с 2 отверстиями для горизонтальной штанги
cm 25 L x 14 P x 6 H



TT 11

Porta rotolo con calamita
Roll holder with magnet
Porte-rouleau avec aimant
Rollenhalter mit Magnet
Держатель рулона с магнитом
cm 12 L x 13 P x 122 H

• 08 - 03 - 05
• 36



TT 1205

Bicchiere in Neolite per Totem
Neolite glass for Totem
Verre de néolite pour Totem
Neolithglas für Totem
Неолитовое стекло для Тотема
cm Ø 7,5 x 13 H

• BI
• NE



TT 1206

Dosatore in Neolite per Totem
Neolite dispenser for Totem
Distributeur de néolite pour Totem
Neolith-Spender für Totem
Неолитовый дозатор для Тотема
cm Ø 7,5 x 17 H

• BI / 08 - 03 - 05
• BI / 36
• NE / 08 - 03 - 05
• NE / 36



LZ 13

Porta accappatoio
Robe hook
Porte peignoir
Bademantelhaken
Крючок
cm 2 L x 5 P x 4 H

• 08 - 03 - 05
• 36



TT47 + TT50 + TT12



TT 039

Porta scopino da appoggio
Toilet-brush with base
Porte balayent d'appui
Bürstengarnitur freistehend
Напольный металлический ёрш
cm Ø 8 x 40,5 H

• 08 - 03 - 05
• 36



TT 039 M

Porta scopino a parete
Wall-mounted toilet-brush
Porte balayent à mur
Bürstengarnitur oval wandhängend
Настенный металлический ёрш
cm Ø 8 x 40,5 H

• 08 - 03 - 05
• 36



TT 05

Asta per connessione a "T" cm 30
Rod for "T" connection cm 30
Tige pour raccord en "T" cm 30
Stange für "T"-Verbindung cm 30
Стержень для "T" соединения cm 30
cm 38,5 L x 8,5 P x 3,5 H

• 08 - 03 - 05
• 36



TT 06

Asta per connessione a "T" cm 45
Rod for "T" connection cm 45
Tige pour raccord en "T" cm 45
Stange für "T"-Verbindung cm 45
Стержень для "T" соединения cm 45
cm 48,5 L x 8,5 P x 3,5 H

• 08 - 03 - 05
• 36



TT 07

Asta per connessione a "T" cm 60
Rod for "T" connection cm 60
Tige pour raccord en "T" cm 60
Stange für "T"-Verbindung cm 60
Стержень для "T" соединения cm 60
cm 63,5 L x 8,5 P x 3,5 H

• 08 - 03 - 05
• 36



TT 08

Asta per connessione a "T" cm 80
Rod for "T" connection cm 80
Tige pour raccord en "T" cm 80
Stange für "T"-Verbindung cm 80
Стержень для "T" соединения cm 80
cm 83,5 L x 8,5 P x 3,5 H

• 08 - 03 - 05
• 36



TT 46

Maniglione ad "L"
L-shaped handle
Poignée en forme de L
L-förmiger Griff
Г-образная ручка
cm 45 L x 8 P x 80 H

• 08 - 03 - 05
• 36



TT 47

Maniglione ad "L"
L-shaped handle
Poignée en forme de L
L-förmiger Griff
Г-образная ручка
cm 60 L x 8 P x 80 H

• 08 - 03 - 05
• 36



TT 48

Maniglione ad "L"
L-shaped handle
Poignée en forme de L
L-förmiger Griff
Г-образная ручка
cm 80 L x 8 P x 80 H

• 08 - 03 - 05
• 36



TT 49

Maniglione ad angolo
Corner handle
Poignée d'angle
Eckgriff
Угловая ручка
cm 60 L x 8 P x 60 H

• 08 - 03 - 05
• 36



TT 50

Doccetta completa di supporto e tubo
Shower complete with stand and hose
Douche complète avec support et tuyau
Dusche komplett mit Ständer und Schlauch
Душ в комплекте со стойкой и шлангом
cm 120,9 L x 4 P x 5 H

• 08 - 03 - 05
• 36



TT 51

Porta accappatoio per barra
Bathrobe holder for bar
Support de peignoir pour le bar
Bademantelhalter für Stange
Держатель банного халата для барной стойки
cm 6,5 L x 4 P x 5 H

• 08 - 03 - 05
• 36



TT 47 + TT 50



TT 49



TT 09 + TT 06

URANIA

_MARCHIO D'AUTORE

Designer: Stilhaus
Materiale: Ottone, tubo 12x12, basetta a muro 50x50
Accessori: Ceramica bianca
Finitura: 08-36-23
Fuori misura: Sì
Incollo: Sì

Designer: Stilhaus
Material: Brass tube 12x12, fixing plate cover 50x50
Accessories: White ceramic
Finishes: 08-36-23
Customized: Yes
By glue: Yes

Designer: Stilhaus
Matière: Laiton, tuyau 12x12, boucle couvre-vis 50x50
Accessoires: Blanc céramique Finitions: 08-36-23
Personnalisé: Oui
Par collage : Oui

Designer: Stilhaus
Material: Messing Rohr 12x12,
Befestigungsplatten Oberfläche 50x50
Zubehör: Weiße Keramik
Ausführungen: 08-36-23
Kundenwunsch: Ja
Kleber: Ja

Дизайн: Stilhaus
Материал: латунь сатин 12x12, 50x50
Аксессуары: белая керамика
Отделка: 08, 36, 23
Негабаритный: да
Установка на клей: да





U 30
U 04



U 039 M



U 06.2



U 13.23



U 04

Mensola vetro 8mm
Shelf
Etagère
Ablage
ограждением- толщина стекла 8 мм
cm 60 L x 12 P x 8 H

• 08 - 23
• 36



U 05

Asta porta asciugamani
Towel rail
Porte serviettes
Handtuchhalter
Полотенцедержатель
cm 60,5 L x 7,5 P x 5 H x 55,5 INT

• 08 - 23
• 36



U 05.2

Porta asciugamani doppia asta
Double towel rail
Porte serviettes avec 2 bars
Handtuchstange doppelt
Полотенцедержатель двойной
cm 60,5 L x 11 P x 5 H x 55,5 INT

• 08 - 23
• 36



U 45

Asta porta asciugamani
Towel rail
Porte serviettes
Handtuchhalter
Полотенцедержатель двойной
cm 45,5 L x 7,5 P x 5 H x 40,5 INT

• 08 - 23
• 36



U 06

Asta porta salviette
Towel rail
Porte serviettes
Handtuchhalter
Полотенцедержатель
cm 30,5 L x 7,5 P x 5 H x 25,3 INT

• 08 - 23
• 36



U 06.2

Porta salviette doppia asta
Double towel rail
Porte serviettes avec 2 bars
Handtuchstange doppelt
Полотенцедержатель двойной
cm 30,5 L x 11 P x 5 H x 25,3 INT

• 08 - 23
• 36



U 06.1

Asta porta salviette
Towel rail
Porte serviettes
Handtuchhalter
Полотенцедержатель двойной поворотный
cm 5 L x 26 P x 5 H

• 08 - 23
• 36



U 16

Porta asciugamani snodo 2 aste
Towel rail with 2 adjustable bar
Porte serviettes à 2 barres orientables
Handtuchhalter schwenkbar 2 Stangen
Полотенцедержатель двойной поворотный
cm 5 L x 33 P x 8 H

• 08 - 23
• 36



U 45 23



U 07

Anello porta salviette
Ring serviette
Porte serviettes à anneau
Handtuchring
Полотенцедержатель - кольцо
cm 20,5 Ø x 5,5 P x 24 H

• 08 - 23
• 36



U 18

Porta asciugamani snodo con porta sapone
Towel rail 2 adjustable bar with soap dish
Porte serviettes à 2 barres orientables avec porte savon
Handtuchhalter schwenkbar mit Seifenschale
Полотенцедержатель двойной поворотный + керамическая мыльница
cm 5 L x 32 P x 10 H

• 08 - 23
• 36



U 18 D

Porta asciugamani snodo con dosatore sapone
Towel rail 2 adjustable bar with soap dispenser
Porte serviettes à 2 barres orientables avec doseur savon
Handtuchhalter schwenkbar mit Seifenspender
Полотенцедержатель двойной поворотный + керамический дозатор
cm 7 L x 32 P x 24 H

• 08 - 23
• 36



U 69

Porta salviette con porta sapone
Serviettes holder with soap dish
Porte serviettes avec porte savon
Handtuchhalter mit Seifenschale
Полотенцедержатель + керамическая мыльница
cm 39 L x 11 P x 7,5 H x 27 INT

• 08 - 23
• 36



U 69 D

Porta salviette con dosatore sapone
Serviettes holder with soap dispenser
Porte serviettes avec doseur de savon
Handtuchhalter mit Seifenspender
Полотенцедержатель + керамический дозатор
cm 39 L x 11 P x 20,5 H x 27 INT

• 08 - 23
• 36



U 09

Porta sapone a parete
Wall mounted ceramic soap dish
Porte savon à mur en céramique
Seifenschale wandhängend aus Keramik
Настенная керамическая мыльница
cm 10 L x 11 P x 7,5 H

• 08 - 23
• 36



U 10

Porta bicchiere a parete
Wall mounted ceramic glass holder
Porte verre à mur en céramique
Zahnbürstenhalter wandhängend aus Keramik
Настенный керамический стакан
cm 7,5 L x 10 P x 15 H

• 08 - 23
• 36



U 14

Porta sapone con Porta bicchiere a parete
Wall mounted soap dish + Glass holder
Porte savon + Porte verre à mur
Seifenschale + Zahnbürstenhalter wandhängend
Настенные керамические стакан + мыльница
cm 20 L x 11 P x 15 H

• 08 - 23
• 36



U 14 D
 Dosatore con Porta bicchiere a parete
 Wall mounted soap dispenser + Glass holder
 Porte savon liquid + Porte verre à mur
 Seifenspender + Zahnbürstenhalter wandhängend
 Настенные керамические стакан + дозатор
 cm 19 L x 10 P x 22 H
 - 08 - 23
 - 36



U 30
 Dosatore sapone liquido a parete
 Wall-mounted soap dispenser
 Doseur de savon
 Seifenspender
 Настенный стеклянный дозатор
 cm 7,5 L x 10 P x 23 H
 - 08 - 23
 - 36



616
 Porta sapone da appoggio
 Soap dish with base
 Porte savon d'appui
 Seifenschale
 Настольная керамическая мыльница
 cm 10 L x 10 P x 5 H
 - 08 - 23
 - 36



617
 Bicchiere d'appoggio
 Glass with base
 Verre base
 Zahnpfutzbecher
 Настольный керамический стакан
 cm 9 L x 9 P x 12 H
 - 08 - 23
 - 36



U 11.2
 Porta rotolo doppio
 Double paper holder
 Porte rouleau double
 Papierrollenhalter doppelt
 Бумагодержатель двойной
 cm 25,5 L x 8,5 P x 5 H
 - 08 - 23
 - 36



618
 Dosatore sapone liquido da appoggio
 Soap dispenser with base
 Doseur de savon d'appui
 Seifenspender
 Настольный керамический дозатор
 cm 9 L x 9 P x 19 H
 - 08 - 23
 - 36



U 13
 Porta accappatoio
 Robe hook
 Porte peignoir
 Bademantelhaken
 Крючок
 cm 5 L x 4,5 P x 5 H
 - 08 - 23
 - 36



U 13.2
 Porta accappatoio (2 ganci)
 Robe hook (2 hooks)
 Porte peignoir (2 peignoir)
 Bademantelhaken (2 Haken)
 Крючок двойной
 cm 5 L x 4,5 P x 5 H
 - 08 - 23
 - 36



U 11
 Porta rotolo
 Paper holder
 Porte rouleau
 Papierrollenhalter
 Бумагодержатель
 cm 16,5 L x 7,5 P x 5 H
 - 08 - 23
 - 36



840
 Kit collante e biadesivo per un articolo
 Kit with bi-adhesive and glue for one article
 Kit avec collant et biadhésif pour un article
 Klebekit ist ein beidseitiger Klebestreifen
 Возможность установки на клей.Б/фдгеш



U 11 36

OPZIONI E COMPLEMENTI / OPZIONI E COMPLEMENTI OPZIONI E COMPLEMENTI / OPZIONI E COMPLEMENTI



08



CROMO
 Chrome
 Chrome
 Chrom
 хром

23



NERO OPACO
 Matt black
 Noir opaque
 Matt schwarz
 черный матовый

36



NICHEL SATINATO
 Satin nickel
 Nickel satiné
 Nickel satiniert
 Никель сатин



Reversibile su richiesta
 Reversible on request / Réversible sur demande /
 Umkehrbar auf Anfrage / Реверсивный по запросу



Su richiesta si realizzano aste porta asciugamani su misura, 20 gg

Customized towel rails are available on request, 20 days
 Des porte-serviettes personnalisés sont disponibles sur demande, 20 jours
 Handtuchhalter sind auf Anfrage erhältlich, 20 Tagen
 По запросу мы можем производить полотенцедержатели под размер 20 дней

- 08 - 23 25 → 44 cm
 - 08 - 23 46 → 90 cm
 - 36 25 → 44 cm
 - 36 46 → 90 cm



> pag. 268



> pag. 306



> pag. 255



> pag. 433



> pag. 339



> pag. 338



> pag. 350



ELITE

_IL PESO DELLO STILE

Designer: Stilhaus
Materiale: ottone, Tubo Ø 16, basetta a muro Ø 63
Accessori: Vetro satinato
Finitura: 08-02-16-25-26-36
Fuori misura: Sì
Incollo: Sì

Designer: Stilhaus
Material: Brass tube Ø 16, fixing plate cover Ø 63
Accessories: Frosted glass
Finishes: 08-02-16-25-26-36
Customized: Yes
By glue : Yes

Designer: Stilhaus
Matière: Laiton, tuyau Ø 16, boucle couvre-vis Ø 63
Accessoires: Verre satin
Finitions: 08-02-16-25-26-36
Personnalisé: Oui
Par collage : Oui

Designer: Stilhaus
Material: Messing Rohr Ø 16, Befestigungsplatten Oberfläche 63
Zubehör: Mattglas
Ausführungen: 08-02-16-25-26-36
Kundenwunsch: Ja
Kleber: Ja

Дизайн: Stilhaus
Материал: латунь Ø 16, Ø 63
Аксессуары: матовое стекло
Отделка: 08-02-16-25-26-36
Негабаритный: да
Установка на клей: да





EL 45



EL 69 D



EL 11



EL 07



EL 06 25



EL 11 C 16



EL 30 36

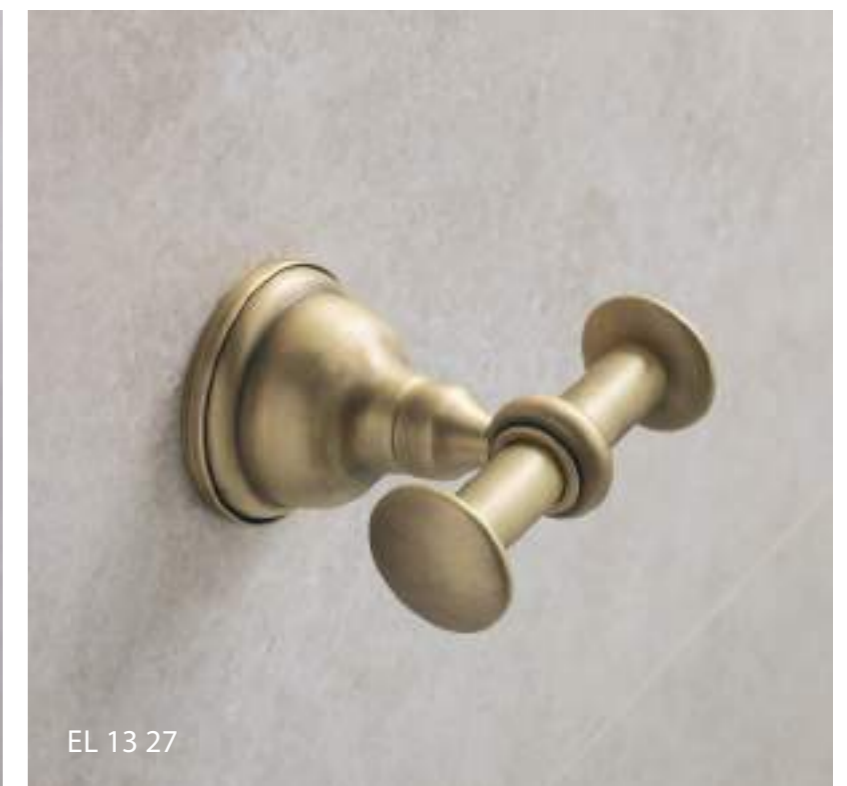

EL 13 27



EL 04

Mensola vetro 8mm
Shelf
Étagère
Ablage
Стекло́нная полка - толщина стекла 8 mm
cm 70 L x 13 P x 6 H x 61,5 INT

- 08
- 02
- 16 - 25 - 26 - 27 - 36



EL 33

Mensola + porta asciugamani
Shelf + towel rail
Étagère + porte serviette
Ablage + Handtuchhalter
Стекло́нная полка + полотенцеде́ржатель
cm 61 L x 15 P x 7 H x 51 INT

- 08
- 02
- 16 - 25 - 26 - 27 - 36



EL 05

Asta porta asciugamani
Towel rail
Porte serviette
Handtuchhalter
Полотенеде́ржатель
cm 61 L x 9 P x 6 H x 51 INT

- 08
- 02
- 16 - 25 - 26 - 27 - 36



EL 05.2

Porta asciugamani doppia asta
Towel rail with 2 bars
Porte serviette avec 2 barres
Handtuchhalter schwenkbar 2 Stangen
Полотенеде́ржатель двойной
cm 61 L x 14 P x 7 H x 51 INT

- 08
- 02
- 16 - 25 - 26 - 27 - 36



EL 45

Asta porta asciugamani
Towel rail
Porte serviette
Handtuchhalter
Полотенеде́ржатель
cm 50 L x 9 P x 6 H x 40 INT

- 08
- 02
- 16 - 25 - 26 - 27 - 36



EL 06

Asta porta salviette
Towel rail
Porte serviettes
Handtuchhalter
Полотенеде́ржатель
cm 42 L x 9 P x 6 H x 31,5 INT

- 08
- 02
- 16 - 25 - 26 - 27 - 36



EL 16

Porta asciugamani snodo 2 aste
Towel rail with 2 adjustable bar
Porte serviettes à 2 barres orientables
Handtuchhalter schwenkbar 2 Stangen
Полотенеде́ржатель двойной поворотный
cm 38 L x 9 P x 16 H

- 08
- 02
- 16 - 25 - 26 - 27 - 36



EL 69

Porta salviette con porta sapone
Towel rail with soap dish
Porte serviettes avec porte savon
Handtuchhalter mit Seifenschale
Полотенеде́ржатель + стекло́нная мыльница
cm 52 L x 12 P x 6 H x 40 INT

- 08
- 02
- 16 - 25 - 26 - 27 - 36



EL 69 D

Porta salviette con dosatore sapone
Towel rail with soap dispenser
Porte serviettes avec porte savon liquid
Handtuchhalter mit Seifenspender
Полотенеде́ржатель + стекло́нный дозатор
cm 50 L x 9 P x 6 H x 40 INT

- 08
- 02
- 16 - 25 - 26 - 27 - 36



EL 07

Anello porta salviette
Ring serviette holder
Porte serviettes à anneau
Handtuchring
Полотенеде́ржатель - полукольцо
cm 30 L x 9 P x 15 H

- 08
- 02
- 16 - 25 - 26 - 27 - 36



EL 79

Anello porta salviette con porta sapone
Ring serviette holder with soap holder
Porte serviettes à anneau avec porte savon
Handtuchring mit Seifenschale
Полотенеде́ржатель - полукольцо + стекло́нная мыльница
cm 30 L x 10 P x 16 H

- 08
- 02
- 16 - 25 - 26 - 27 - 36



EL 79 D

Anello porta salviette con dosatore sapone
Ring serviette holder with soap dispenser
Porte serviettes à anneau avec porte savon liquid
Handtuchring mit Seifenspender
Полотенеде́ржатель - полукольцо + стекло́нный дозатор
cm 30 L x 9 P x 22 H

- 08
- 02
- 16 - 25 - 26 - 27 - 36



EL 15



EL 09

Porta sapone a parete
Wall mounted soap dish
Porte savon à mur
Seifenschale wandhängend
Настенная стеклянная мыльница
cm 20 L x 11 P x 6 H

-
- 08
-
- 02
-
- 16 - 25 - 26 - 27 - 36



EL 10

Porta bicchiere a parete
Wall mounted holder
Porte à mur
Zahnbürstenhalter wandhängend
Настенный стеклянный стакан
cm 8 L x 11 P x 12 H

-
- 08
-
- 02
-
- 16 - 25 - 26 - 27 - 36



EL 30

Dosatore sapone liquido a parete
Wall-mounted soap dispenser
Doseur de savon
Seifenspender
Настенный стеклянный дозатор
cm 18 L x 11 P x 18 H

-
- 08
-
- 02
-
- 16 - 25 - 26 - 27 - 36



EL 14

Porta sapone con porta bicchiere a parete
Wall mounted soap dish + Glass holder
Porte savon + Porte verre mural
Seifenschale + Zahnbürstenhalter wandhängend
Настенные стеклянные стакан + мыльница
cm 26 L x 11 P x 12 H

-
- 08
-
- 02
-
- 16 - 25 - 26 - 27 - 36



EL 039

Porta scopino da appoggio
Toilet-brush with base
Porte balayent d'appui
Bürstengarnitur freistehend
Напольный металлический ёрш
cm 12,5 Ø x 40 H

-
- 08
-
- 02
-
- 16 - 25 - 26 - 27 - 36



EL 11.11 S

Porta rotolo con scorta
Paper holder with supply
Porte rouleau avec escorte
Papierrollenhalter mit Ersatzhalter
Бумагодержатель двойной
cm 24 L x 9 P x 13 H

-
- 08
-
- 02
-
- 16 - 25 - 26 - 27 - 36



EL 1016

Maniglia per box doccia
Handle for shower enclosure
Poignée pour cabinets de douche
Handgriff für Duschkabinen
Ручка для душевого угла
cm 2 L x 6 P x 26 H - INT. 14

-
- 08
-
- 02
-
- 16 - 25 - 26 - 27 - 36

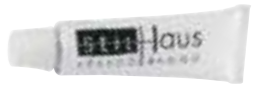

840

Kit collante e biadesivo per un articolo
Kit with bi-adhesive and glue for one article
Kit avec collant et biadhésif pour one article
Klebekit ist ein beidseitiger Klebestreifen
Возможность установки на клей.Б/фдгеш

.....



EL 09 AP

Porta sapone da appoggio
Soap dish with base
Porte savon d'appui
Seifenschale freistehend
Настольная стеклянная мыльница
cm 15 L x 14 P x 12 H

-
- 08
-
- 02
-
- 16 - 25 - 26 - 27 - 36



EL 10 AP

Porta bicchiere da appoggio
Glass holder with base
Porte verre d'appui
Zahnbürstenhalter freistehend
Настольный стеклянный стакан
cm 9 L x 14 P x 12 H

-
- 08
-
- 02
-
- 16 - 25 - 26 - 27 - 36



EL 30 AP

Dosatore sapone liquido da appoggio
Soap dispenser with base
Porte savon d'appui
Seifenspender freistehend
Настольный стеклянный дозатор
cm Ø 8 x 18 H

-
- 08
-
- 02
-
- 16 - 25 - 26 - 27 - 36



EL 15

Porta sapone + Porta bicchiere da appoggio
Soap dish + Glass holder with base
Porte savon + Porte verre d'appui
Seifenschale + Zahnbürstenhalter freistehend
Настольные стеклянные стакан + мыльница
cm Ø 12,5 x 18 H

-
- 08
-
- 02
-
- 16 - 25 - 26 - 27 - 36

OPZIONI E COMPLEMENTI / OPZIONI E COMPLEMENTI OPZIONI E COMPLEMENTI / OPZIONI E COMPLEMENTI / OPZIONI E COMPLEMENTI

* FINITURA DISPONIBILE IN 20 GG. / Finish available in 20 days / Finition disponible en 20 jours / Oberfläche lieferbar in 20 Tagen / Отделка доступна в течение 20 дней



08
CROMO
Chrome
Chrom
хром

36*
NICHEL SATINATO
Satin nickel
Nickel satiné
Nickel satiniert
Никель сатин

02
CROMO - ORO
Chrome - gold
Chrome - or
Chrom - Gold
Хром - золото

16
ORO
Gold
Or
Gold
Золото

25
BRONZO LUCIDO
Polish bronze
Bronze poli
Bronzopolitidch
Бронза

26*
RAME
Copper
Cuivre
Kupfer
Медь

27*
BRONZO OPACO
Matt bronze
Bronze mat
Matte bronze
Медь

↔ Reversibile su richiesta
Reversible on request / Réversible sur demande /
Umkehrbar auf Anfrage / Реверсивный по запросу



EL 13

Porta accappatoio (2 ganci)
Robie hook (2 hooks)
Porte peignoir (2 peignoir)
Bademantelhaken (2 Haken)
Крючок двойной
cm 8 L x 9 P x 6 H

-
- 08
-
- 02
-
- 16 - 25 - 26 - 27 - 36



EL 11

Porta rotolo
Paper holder
Porte rouleau
Papierrollenhalter
Бумагодержатель
cm 19,5 L x 9 P x 6 H

-
- 08
-
- 02
-
- 16 - 25 - 26 - 27 - 36



EL 11 C

Porta rotolo coperto
Covered paper holder
Porte rouleau avec couvercle
Papierrollenhalter mit Deckel
Бумагодержатель с крышкой
cm 20,5 L x 11 P x 11 H

-
- 08
-
- 02
-
- 16 - 25 - 26 - 27 - 36



EL 12

Porta scopino a parete
Wall mounted toilet brush
Porte balayette à mur
Bürstengarnitur wandhängend
Настенный стеклянный ёрш
cm 10 L x 14 P x 35 H

-
- 08
-
- 02
-
- 16 - 25 - 26 - 27 - 36



Su richiesta si realizzano aste porta asciugamani su misura, 10 gg

Customized towel rails are available on request, 10 days
Des porte-serviettes personnalisés sont disponibles sur demande, 10 jours
Handtuchhalter sind auf Anfrage erhältlich, 10 tagen
По запросу мы можем производить полотенцедержатели под размер 10 дней



- 08	25	→	49 cm
- 08	51	→	100 cm
.....			
- 02	25	→	49 cm
- 02	51	→	100 cm
.....			
- 16-25-26-36	25	→	49 cm
- 16-25-26-36	51	→	100 cm



- > pag. 288
- > pag. 312
- > pag. 344
- > pag. 322
- > pag. 430
- > pag. 436
- > pag. 321

GIUNONE

_LA CURA DEL DETTAGLIO

Designer: Stilhaus
Materiale: Ottone, Tubo Ø 15, basetta a muro Ø 63
Accessori: Ceramica bianca
Finitura: 08-02-16-25-26-36
Fuori misura: Sì

Designer: Stilhaus
Material: Brass tube Ø15, fixing plate cover Ø 63
Accessories: White ceramic
Finishes: 08-02-16-25-26-36
Customized: Yes

Designer: Stilhaus
Matière: Laiton, tuyau Ø 15,
boucle couvre-vis Ø 63
Accessoires: blanc céramique
Finitions: 08-02-16-25-26-36
Personnalisé: Oui

Designer: Stilhaus
Material: Messing Rohr Ø 15,
Befestigungsplatten Oberfläche Ø 63
Zubehör: weiße Keramik
Ausführungen: 08-02-16-25-26-36
Kundenwunsch: Ja

Дизайн: Stilhaus
Материал: латунь Ø 15, Ø 63
Аксессуары: белая керамика
Отделка: 08-02-16-25-26-36
Негабаритный: да





G 07 16
G 09 16



G 15



G 05.2

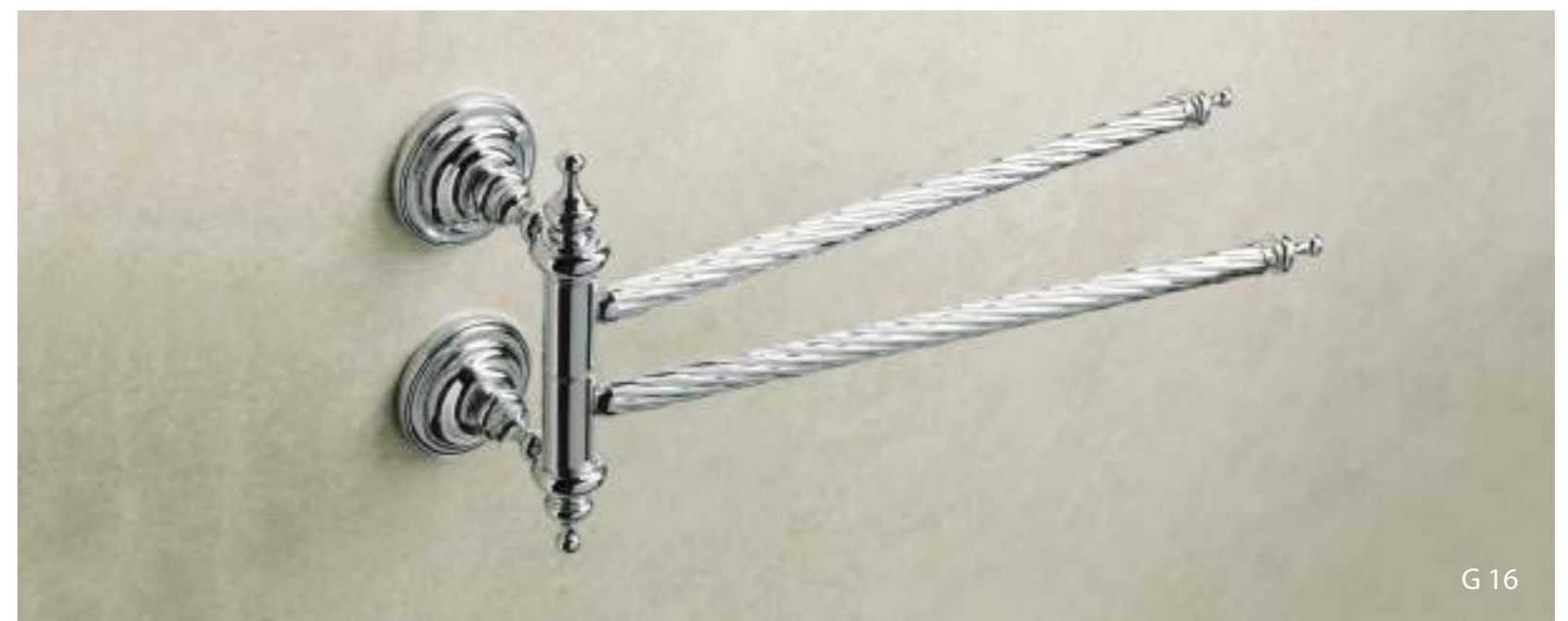

G 16

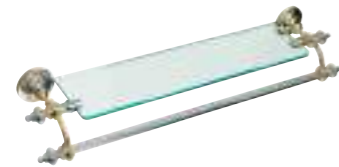
**G 04**

Mensola vetro 8mm
Shelf
Etagère
Ablage
Стеклянная полка - толщина стекла 8 mm
cm 70 L x 13 P x 6 H - INT. 61

- 08
- 02
- 16 - 25 - 26 - 36

G 33

Mensola e porta asciugamani
Shelf and towel rail
Etagère et porte serviette
Ablage mit Handtuchhalter
Стеклянная полка + полотенцедержатель
cm 60 L x 15 P x 9 H - INT. 51

- 08
- 02
- 16 - 25 - 26 - 36

G 05

Asta porta asciugamani
Towel rail
Porte serviette
Handtuchhalter
Полотенцедержатель + керамическая мыльница
cm 60 L x 8 P x 6 H - INT. 51

- 08
- 02
- 16 - 25 - 26 - 36

G 05.2

Porta asciugamani doppia asta
Towel rail with 2 bars
Porte serviette avec 2 barres
Handtuchhalter schwenkbar 2 Stangen
Полотенцедержатель двойной
cm 60 L x 14 P x 9 H - INT. 51

- 08
- 02
- 16 - 25 - 26 - 36

**G 06**

Asta porta asciugamani
Towel rail
Porte serviette
Handtuchhalter
Полотенцедержатель
cm 40,5 L x 8 P x 6 H - INT. 31

- 08
- 02
- 16 - 25 - 26 - 36

G 16

Porta asciugamani snodo 2 aste
Towel rail with 2 adjustable bar
Porte serviettes à 2 barres orientables
Handtuchhalter schwenkbar 2 Stangen
Полотенцедержатель двойной поворотный
cm 38 L x 8 P x 16 H

- 08
- 02
- 16 - 25 - 26 - 36

G 69

Asta porta salviette con porta sapone
Towel rail with soap dish
Porte serviettes avec porte savon
Handtuchhalter mit Seifenschale
Полотенцедержатель + керамическая мыльница
cm 50 L x 13 P x 6 H - INT. 31

- 08
- 02
- 16 - 25 - 26 - 36

G 69 D

Asta porta salviette con dosatore sapone
Towel rail with soap dispenser
Porte serviettes avec porte savon liquid
Handtuchhalter mit Seifenspender
Полотенцедержатель + керамический дозатор
cm 50 L x 13 P x 6 H - INT. 31

- 08
- 02
- 16 - 25 - 26 - 36

**G 79**

Porta salviette con porta sapone
Wall mounted holder serviette + soap dish
Porte serviette + Porte savon mural
Handtuchhalter + Seifenschale
Полотенцедержатель - полукольцо + керамическая мыльница
cm 31 L x 13 P x 13 H

- 08
- 02
- 16 - 25 - 26 - 36

G 07

Anello porta salviette
Ring serviette holder
Porte serviettes à anneau
Handtuchring
Полотенцедержатель - полукольцо
cm 31 L x 8 P x 13 H

- 08
- 02
- 16 - 25 - 26 - 36

G 09

Porta sapone a parete
Wall mounted soap dish
Porte savon à mur
Seifenschale wandhängend
Настенная керамическая мыльница
cm 24 L x 13 P x 6 H

- 08
- 02
- 16 - 25 - 26 - 36

G 10

Porta bicchiere a parete
Wall mounted glass holder
Porte verre à mur
Zahnbürstenhalter wandhängend
Настенный керамический стакан
cm 18 L x 13 P x 12 H

- 08
- 02
- 16 - 25 - 26 - 36



G 12 A 25
G 11 C 25



G 30

Dosatore sapone liquido
Wall mounted soap dispenser
Porte savon liquid à mur
Seifenspender wandhängend
Настенный керамический
cm 24 L x 13 P x 6 H

- 08

- 02

- 16 - 25 - 26 - 36



G 14

Porta sapone con porta bicchiere a parete
Wall mounted soap dish + Glass holder
Porte savon + Porte verre à mur
Seifenschale + Zahnbürstenhalter wandhängend
Настенные керамические стакан + мыльница
cm 30 L x 13 P x 12 H

- 08

- 02

- 16 - 25 - 26 - 36



G 719

Porta sapone da appoggio
Soap dish with base
Porte savon d'appui
Seifenschale freistehend
Настольная керамическая мыльница
cm 13 L x 10 P x 11 H - base cm Ø 10

- 08

- 02

- 16 - 25 - 26 - 36



G 718

Porta bicchiere da appoggio
Glass holder with base
Porte verre d'appui
Zahnbürstenhalter freistehend
Настольный керамический стакан
cm 10 L x 15 P x 15 H - base cm Ø 10

- 08

- 02

- 16 - 25 - 26 - 36



G 039

Porta scopino da appoggio
Toilet brush with base
Porte balayent d'appui
Bürstengarnitur freistehend
Напольный металлический ёрш
cm 12 Ø x 38 H

- 08

- 02

- 16 - 25 - 26 - 36

OPZIONI E COMPLEMENTI / OPZIONI E COMPLEMENTI / OPZIONI E COMPLEMENTI / OPZIONI E COMPLEMENTI

* FINITURA DISPONIBILE IN 20 GG. / Finish available in 20 days / Finition disponible en 20 jours / Oberfläche lieferbar in 20 Tagen / Отделка доступна в течение 20 дней



08

CROMO
Chrome
Chrome
Chrom
хром



16

ORO
Gold
Or
Gold
Золото



26*

RAME
Copper
Cuivre
Kupfer
Медь



02

CROMO - ORO
Chrome - gold
Chrome - or
Chrom - Gold
Хром - золото

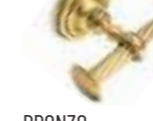

25

BRONZO
Bronze
Bronze
Bronze
Бронза

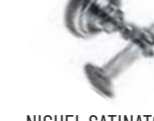

36*

NICHEL SATINATO
Satin nickel
Nickel satiné
Nickel matt
Никель сатин

↔ Reversibile su richiesta
Reversible on request / Réversible sur demande /
Umkehrbar auf Anfrage / Реверсивный по запросу



Su richiesta si realizzano aste porta asciugamani su misura, 10 gg

Customized towel rails are available on request, 10 days
Des porte-serviettes personnalisés sont disponibles sur demande, 10 jours
Handtuchhalter sind auf Anfrage erhältlich, 10 tagen
По запросу мы можем производить полотенцедержатели под размер 10 дней



- 08 30 → 59 cm

- 08 61 → 100 cm

- 02 30 → 59 cm

- 02 61 → 100 cm

- 16-25-26-36 30 → 59 cm

- 16-25-26-36 61 → 100 cm



G 11

Porta rotolo
Paper holder
Porte rouleau
Papierrollenhalter
Бумагодержатель
cm 25 L x 8 P x 6 H

- 08

- 02

- 16 - 25 - 26 - 36



G 11 C

Porta rotolo coperto
Covered paper holder
Porte rouleau avec couvercle
Papierrollenhalter mit Deckel
Бумагодержатель закрытый
cm 25 L x 11,5 P x 11 H

- 08

- 02

- 16 - 25 - 26 - 36



G 12 A

Porta scopino d'appoggio in ceramica
Ceramic toilet brush
Porte balayent en ceramique
Bürstengarnitur freistehend aus Keramik
Напольный керамический ёрш
cm Ø 13 x 40 H

- 08

- 02

- 16 - 25 - 26 - 36



G 12

Porta scopino a parete
Wall mounted toilet brush
Porte balayent à mur
Bürstengarnitur wandhängend
Настенный керамический ёрш
cm 10 L x 12 P x 34 H

- 08

- 02

- 16 - 25 - 26 - 36



> pag. 288



> pag. 298



> pag. 322



> pag. 348



> pag. 430



> pag. 430

IDRA

_L'ECCELLENZA DEL DETTAGLIO

Designer: Stilhaus
Materiale: ottone, Tubo Ø 12, basetta a muro Ø 60
Accessori: Ceramica
Finitura: 08-12-25-26
Fuori misura: Sì
Incollo: Sì

Designer: Stilhaus
Material: Brass tube Ø 12, fixing plate cover Ø60
Accessories: White ceramic
Finishes: 08-12-25-26
Customized: Yes
by glue : Yes

Designer: Stilhaus
Matière: Laiton, tuyau Ø 12, boucle couvre-vis Ø 60
Accessoires: Blanc céramique
Finitions: 08-12-25-26
Personnalisé: Oui
Par collage : Oui

Designer: Stilhaus
Material: Messing Rohr Ø 12, befestigungsplatten oberfläche Ø 60
Zubehör: Weiße Keramik
Ausführungen: 08-12-25-26
Kundenwunsch: Ja
Kleber: Ja

Дизайн: Stilhaus
Материал: латунь
Аксессуары: керамика
Отделка: 08-12-25-26
Негабаритный: да
Установка на клей: да





i 823
i 11



i 45



i 10

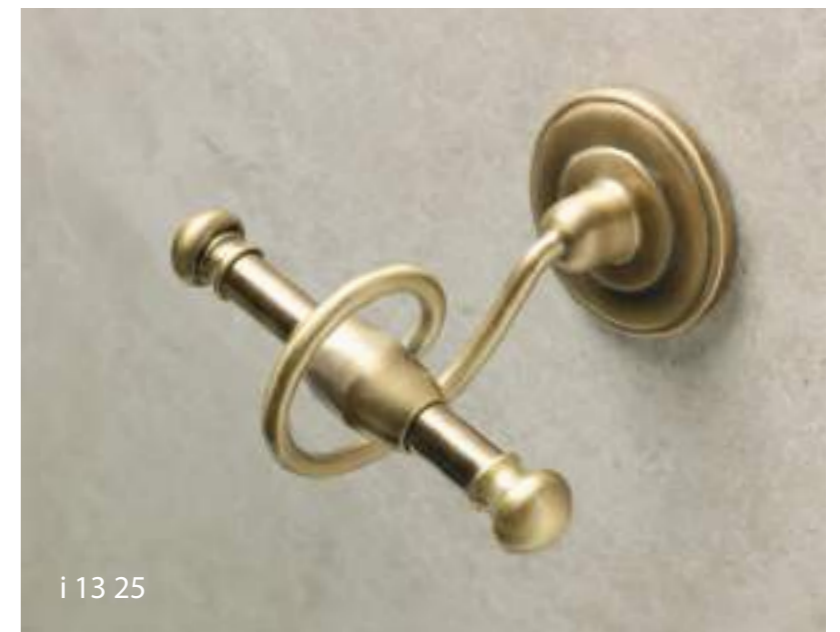

i 13 25



i 04

Mensola vetro 8mm
Shelf
Etagère
Ablage
Стеклоянная полка - толщина стекла 8mm
cm 70 L x 12 P x 10 H x 64 INT

• 08 - 12
• 25 - 26



i 05

Asta porta asciugamani
Towel rail
Porte serviette
Handtuchhalter
Полотенцедержатель
cm 63 L x 12 P x 10 H x 52 INT

• 08 - 12
• 25 - 26



i 45

Asta porta asciugamani
Towel rail
Porte serviette
Handtuchhalter
Полотенцедержатель
cm 45 L x 12 P x 10 H x 34 INT

• 08 - 12
• 25 - 26



i 06

Asta porta salviette
Towel rail
Porte serviette
Handtuchhalter
Полотенцедержатель
cm 34 L x 12 P x 10 H x 22,50 INT

• 08 - 12
• 25 - 26



i 69

Asta porta salviette con porta sapone
Serviette holder with soap dish
Porte serviettes avec porte savon
Handtuchhalter mit Seifenschale
Полотенцедержатель + керамическая мыльница
cm 58 L x 14 P x 10 H x 36,5 INT

• 08 - 12
• 25 - 26



i 16

Porta asciugamani snodo 2 aste
Towel rail with 2 adjustable bar
Porte serviettes à 2 barres orientables
Handtuchhalter schwenkbar 2 Stangen
Полотенцедержатель двойной поворотный
cm 38 L x 6 P x H 18

• 08 - 12
• 25 - 26



i 18

Porta asciugamani snodo 2 aste con portasapone
Towel rail with 2 adjustable bar soap dish
Porte serviettes à 2 barres avec porte savon
Schwenkbar 2 Stangen und Seifenschale
Полотенцедержатель двойной поворотный + керамическая мыльница
cm 38 L x 12 P x 22 H

• 08 - 12
• 25 - 26



i 07

Anello porta salviette
Ring serviette holder
Porte serviettes à anneau
Handtuchring
Полотенцедержатель - кольцо
cm 23 L x 10 P x 28 H

• 08 - 12
• 25 - 26



i 09

Porta sapone a parete
Wall mounted soap dish
Porte savon à mur
Seifenschale wandhängend
Настенная керамическая мыльница
cm 21 L x 14 P x 10 H

• 08 - 12
• 25 - 26



i 10

Porta bicchiere a parete
Wall mounted glass holder
Porte verre à mur
Zahnbürstenhalter wandhängend
Настенный керамический стакан
cm 18 L x 13 P x 13 H

• 08 - 12
• 25 - 26



i 14

Porta sapone con porta bicchiere a parete
Wall mounted soap dish + Glass holder
Porte savon + Porte verre à mur
Seifenschale + Zahnbürstenhalter wandhängend
Настенные керамические стакан + мыльница
cm 30 L x 14 P x 13 H

• 08 - 12
• 25 - 26



i 15

Porta sapone con porta bicchiere da appoggio
Soap dish + Glass holder
Porte savon + Porte verre
Seifenschale + Zahnbürstenhalter freistehend
Настольные керамические мыльница + стакан
cm 30 L x Ø 12,5 x 16 H

• 08 - 12
• 25 - 26



i 07





i 13

Porta accappatoio (2 ganci)
Robie hook (2 hooks)
Porte peignoir (2 peignoir)
Bademantelhaken (2 Haken)
Крючок двойной
cm 13 L x 12 P x 10 H

• 08 - 12
• 25 - 26



i 11

Porta rotolo
Paper holder
Porte rouleau
Papierrollenhalter
Бумагодержатель
cm 22 L x 12 P x 10 H

• 08 - 12
• 25 - 26



i 12 A

Porta scopino d'appoggio in ceramica
Ceramic toilet brush
Porte balayent en ceramique
Bürstengarnitur freistehend aus Keramik
Напольный керамический ёрш
cm 13 Ø x 40 H

• 08 - 12
• 25 - 26



i 823

Porta scopino d'appoggio in ceramica
Ceramic toilet brush
Porte balayent en ceramique
Bürstengarnitur freistehend aus Ceramic
Напольный керамический ёрш
cm 14 Ø x 40 H

• 08 - 12
• 25



i 039

Porta scopino da appoggio
Toilet brush with base
Porte balayent d'appui
Bürstengarnitur freistehend
Напольный металлический ёрш
cm 12,5 Ø x 40 H

• 08 - 12
• 25 - 26



840

Kit collante e biadesivo per un articolo
Kit with bi-adhesive and glue for one article
Kit avec collant et biadhésif pour un article
Klebekit ist ein beidseitiger Klebestreifen
Клей



i 09 25

OPZIONI E COMPLEMENTI / OPZIONI E COMPLEMENTI / OPZIONI E COMPLEMENTI / OPZIONI E COMPLEMENTI / OPZIONI E COMPLEMENTI

* FINITURA DISPONIBILE IN 20 GG. / Finish available in 20 days / Finition disponible en 20 jours / Oberfläche lieferbar in 20 Tagen / Отделка доступна в течение 20 дней



08



CROMO
Chrome
Chrom
хром

25



BRONZO
Bronze
Bronze
Бронза

26*



RAME
Copper
Cuivre
Kupfer
Медь

12*



NIKEL LUCIDO
Polish nickel
Nikel poli
Nikel poliert
Глянцевый никель



Su richiesta si realizzano aste porta asciugamani su misura, 10 gg

Customized towel rails are available on request, 10 days
Des porte-serviettes personnalisés sont disponibles sur demande, 10 jours
Handtuchhalter sind auf Anfrage erhältlich, 10 Tagen
По запросу мы можем производить полотенцедержатели под размер 10 дней



• 08 - 12 28 → 44 cm
• 08 - 12 46 → 90 cm
• 25 - 26 28 → 44 cm
• 25 - 26 46 → 90 cm



> pag. 288



> pag. 313



> pag. 299



> pag. 322



> pag. 346



> pag. 346



> pag. 436



> pag. 318

↔ Reversibile su richiesta / Reversible on request / Réversible sur demande / Umkehrbar auf Anfrage / Реверсивный по запросу

✂ Possibilità di fissaggio ad incollo / Possibility of installation by glue / Possibilité de fixation par colle / Befestigungsmöglichkeit mit Klebstoff / возможность установки на клей

MARTE

_LA CHIAVE DI VOLTA

Designer: Stilhaus
Materiale: Ottone, Tubo Ø 16, basetta a muro Ø 70
Accessori: Vetro Trasparente
Finitura: 08-16-25 - 36
Fuori misura: Sì
Incollo: Sì

Designer: Stilhaus
Material: Brass tube Ø 16, fixing plate cover Ø 70
Accessories: Transparent glass
Finishes: 08-16-25 - 36
Customized: Yes
By glue : Yes

Designer: Stilhaus
Matière: Laiton, tuyau Ø 16, boucle couvre-vis Ø 70
Accessoires: Verre transparent
Finitions: 08-16-25 - 36
Personnalisé: Oui
Incollo: Oui

Designer: Stilhaus
Material: Messing Rohr Ø 16, Befestigungsplatten Oberfläche Ø 70
Zubehör: Klarglas
Ausführungen: 08-16-25 - 36
Kundenwunsch: Ja
Kleber: Ja

Дизайн: Stilhaus
Материал: латунь Ø 16, Ø 70
Аксессуары: прозрачное стекло
Отделка: 08-16-25 - 36
Негабаритный: да
Установка на клей: да





MA 09
MA 10
MA 30



MA 45



MA 11



MA 07



MA 11 C 25



MA 13 36



MA 45 16



MA 04
 Mensola vetro 8mm
 Shelf
 Etegerè
 Ablage
 Стеклая полка - толщина стекла 8mm
 cm 60 L x 13 P x 7 H
 - 08
 - 16 - 25 - 36



MA 05
 Asta porta asciugamani
 Towel rail
 Porte serviette
 Handtuchhalter
 Полотенцедержатель
 cm 60 L x 9 P x 7 H - INT. 51,5
 - 08
 - 16 - 25 - 36



MA 45
 Asta porta asciugamani
 Towel rail
 Porte serviette
 Handtuchhalter
 Полотенцедержатель
 cm 49 L x 9 P x 7 H - INT. 40,5
 - 08
 - 16 - 25 - 36



MA 06
 Asta porta salviette
 Ring towel serviette
 Porte serviettes anneau
 Handtuchring
 Полотенцедержатель
 cm 39 L x 9 P x 7 H - INT. 30,5
 - 08
 - 16 - 25 - 36



MA 13
 Porta accappatoio (2 ganci)
 Robie hook (2 hooks)
 Porte peignpir (2 peignoir)
 Bademantelhaken (2 Haken)
 Крючок двойной
 cm 9 L x 8,5 P x 7 H
 - 08
 - 16 - 25 - 36



MA 11
 Porta rotolo
 Paper holder
 Porte rouleau
 Papierrollenhalter
 Бумагодержатель
 cm 19,5 L x 9 P x 7 H
 - 08
 - 16 - 25 - 36



MA 11 C
 Porta rotolo con coperchio
 Covered paper holder
 Porte rouleau avec couvercle
 Papierrollenhalter mit Deckel
 Бумагодержатель с крышкой
 cm 20,5 L x 14 P x 12 H
 - 08
 - 16 - 25 - 36



MA 039
 Porta scopino
 Toilet-brush
 Porte balayent
 Bürstengarnitur
 Напольный металлический ёрш
 cm 12,5 Ø x 41,5 H
 - 08
 - 16 - 25 - 36



MA 16
 Porta asciugamani snodo 2 aste
 Towel rail with 2 adjustable bar
 Porte serviettes à 2 barres orientables
 Handtuchhalter schwenkbar 2 Stangen
 Полотенцедержатель двойной поворотный
 cm 4,5 L x 43 P x 19 H
 - 08
 - 16 - 25 - 36



MA 07
 Anello porta salviette
 Ring towel serviette
 Porte serviettes anneau
 Handtuchring
 Полотенцедержатель - кольцо
 cm 23,5 L x 8 P x 23,5 H
 - 08
 - 16 - 25 - 36



MA 09
 Porta sapone a parete
 Wall-mounted soap dish
 Porte savon à mur
 Seifenschale
 Настенная стеклянная мыльница
 cm 12,5 L x 15,5 P x 7 H
 - 08
 - 16 - 25 - 36



MA 10
 Porta bicchiere a parete
 Wall mounted glass holder
 Porte verre à mur
 Zahnbürstenhalter wandhängend
 Настенный стеклянный стакан
 cm 8 L x 13,5 P x 12 H
 - 08
 - 16 - 25 - 36

OPZIONI E COMPLEMENTI / OPZIONI E COMPLEMENTI OPZIONI E COMPLEMENTI / OPZIONI E COMPLEMENTI / OPZIONI E COMPLEMENTI

* FINITURA DISPONIBILE IN 20 GG. / Finish available in 20 days / Finition disponible en 20 jours / Oberfläche lieferbar in 20 Tagen / Отделка доступна в течение 20 дней



08



CROMO
 Chrome
 Chrome
 Chrom
 хром

16



ORO
 Gold
 Or
 Gold
 Золото

25



BRONZO
 Bronze
 Bronze
 Bronze
 Бронза

36*



NICHEL SATINATO
 Satin nickel
 Nickel satiné
 Nickel matt
 Никель сатин



Reversibile su richiesta / Reversible on request / Réversible sur demande / Umkehrbar auf Anfrage / Реверсивный по запросу



Su richiesta si realizzano aste porta asciugamani su misura, 15 gg

Customized towel rails are available on request, 15 days
 Des porte-serviettes personnalisés sont disponibles sur demande, 15 jours
 Handtuchhalter sind auf Anfrage erhältlich, 15 tagen
 По запросу мы можем производить полотенцедержатели под размер 15 дней



- 08 28 → 48 cm
 - 08 50 → 100 cm
 - 16 - 25 28 → 48 cm
 - 16 - 25 50 → 100 cm



MA 30
 Dosatore sapone liquido a parete
 Wall mounted liquid soap dispenser
 Doseur de savon liquid à mur
 Seifenspender wandhängend
 Настенный стеклянный дозатор
 cm 7,5 L x 13,5 P x 19 H
 - 08
 - 16 - 25 - 36



MA 09 AP
 Porta sapone da appoggio
 Soap dish with base
 Porte savon d'appui
 Seifenschale freistehend
 Настольная стеклянная мыльница
 cm 12,5 Ø x 7 H
 - 08
 - 16 - 25 - 36



MA 10 AP
 Porta bicchiere da appoggio
 Glass holder with base
 Porte verre d'appui
 Zahnbürstenhalter freistehend
 Настольный стеклянный стакан
 cm 9 Ø x 14 H
 - 08
 - 16 - 25 - 36



MA 30 AP
 Dosatore sapone liquido da appoggio
 Soap dispenser with base
 Porte savon d'appui
 Seifenspender freistehend
 Настольный стеклянный дозатор
 cm 9 Ø x 19 H
 - 08
 - 16 - 25 - 36



> pag. 286



> pag. 308



> pag. 436



> pag. 322

NEMI

_ESPRESSIONE D'ARTE

Designer: Stilhaus
Materiale: Ottone, tubo Ø 20, basetta a muro Ø 60, legno, ceramica bianca o decorata
Accessori: ceramica
Finitura: 33-39-40
Fuori misura: Sì
Incollo: Sì

Designer: Stilhaus
Material: Brass tube Ø 16, fixing plate cove Ø60, wood, white or decorated ceramic
Accessories: Ceramic
Finishes: 33-39-40
Customized: Yes
By glue : Yes

Designer: Stilhaus
Matière: laiton, tuyau Ø 16, boucle couvre-vis Ø 60, bois, blanc et noir céramique
Accessoires: Céramique
Finitions: 33-39-40
Personnalisé: Oui
Par collage : Oui

Designer: Stilhaus
Material: Messing Rohr Ø 16, Befestigungsplatten Oberfläche Ø60, Holz, Keramik weiß oder dekoriert
Zubehör: Keramik
Ausführungen: 33-39-40
Kundenwunsch: Ja
Kleber: Ja

Дизайн: Stilhaus
Материал: латунь, дерево, Ø 16, Ø 60 белая или декорированная керамика
Аксессуары: керамика
Отделка: 33-39-40
Негабаритный: да
Установка на клей: да







N 04

Mensola vetro 8 mm
Shelf
Etagère
Ablage
Стеклопанельная полка - толщина стекла 8 mm
cm 70 L x 12 P x 10 H - INT. 62

- 33 - 39
- 40

N 05

Asta porta asciugamani
Towel rail
Porte serviette
Handtuchhalter
Полотенцедержатель
cm 60 L x 9 P x 10 H - INT. 51

- 33 - 39
- 40

N 05.2

Porta asciugamani doppia asta
Towel rail with 2 bars
Porte serviette avec 2 barres
Doppel Handtuchstange
Полотенцедержатель двойной
cm 60 L x 12 P x 16 H - INT. 51

- 33 - 39
- 40

N 06

Asta porta salviette
Serviette holder
Porte serviette
Handtuchhalter
Полотенцедержатель
cm 43 L x 9 P x 10 H - INT. 30

- 33 - 39
- 40



N 16

Porta asciugamani snodo 2 aste
Towel rail with 2 adjustable bar
Porte serviettes à 2 barres orientables
Handtuchhalter schwenkbar 2 Stangen
Полотенцедержатель двойной поворотный
cm 40 L x 4 P x 15 H

- 33 - 39
- 40

N 79

Porta salviette con porta sapone
Wall mounted holder serviette soap dish
Porte serviette + Porte savon à mur
Handtuchhalter + Seifenschale
Полотенцедержатель - полукольцо + мыльница
cm 35 L x 13 P x 18 H

- 33 - 39
- 40

N 07

Anello porta salviette
Ring serviette holder
Porte serviettes à anneau
Handtuchring
Полотенцедержатель - полукольцо
cm 35 L x 9 P x 18 H

- 33 - 39
- 40

N 09

Porta sapone a parete
Wall mounted soap dish
Porte savon à mur
Seifenschale wandhängend
Настенная керамическая мыльница
cm 21 L x 13 P x 10 H

- 33 - 39
- 40



N 10

Porta bicchiere a parete
Wall mounted glass holder
Porte verre mural
Zahnbürstenhalter wandhängend
Настенный керамический стакан
cm 18 L x 10 P x 18 H

- 33 - 39
- 40

N 14

Porta sapone con porta bicchiere a parete
Wall mounted soap dish + Glass holder
Porte savon + Porte verre mural
Seifenschale + Zahnbürstenhalter wandhängend
Настенные керамические мыльница + стакан
cm 32 L x 13 P x 18 H

- 33 - 39
- 40

743

Porta sapone da appoggio
Soap dish with base
Porte savon d'appui
Seifenschale
Настольная керамическая мыльница
cm 32 L x 13 P x 5 H

- 01
- 40

744

Bicchiere in ceramica d'appoggio
Glass with base
Verre d'appui
Zahnputzbecher
Настольный керамический стакан
cm Ø 9 x 11 H

- 01
- 40



N 09 40



558
 Dosatore sapone liquido d'appoggio
 Soap dispenser with base
 Doseur de savon liquid d'appui
 Seifenspender
 Настольный керамический дозатор
 cm Ø 8 x 18 H

- 01
 - 40



745
 Contenitore in ceramica d'appoggio
 Container with base
 Containeur d'appui
 Keramik Dose
 Настольный керамический контейнер
 cm Ø 9 x 13 H

- 01
 - 40



N 15 M
 Porta sapone con porta bicchiere da appoggio
 Soap dish + Glass holder
 Porte savon + Porte verre
 Seifenschale + Zahnbürstenhalter freistehend
 Настольные керамические мыльница + стакан
 cm 30 L x Ø 12,5 x 18 H

- 33 - 39
 - 40



N 13
 Porta accappatoio (2 ganci)
 Robie hook (2 hooks)
 Porte peignoir (2 peignoir)
 Bademantelhaken (2 Haken)
 Крючок двойной
 cm 10 L x 9 P x 10 H

- 33 - 39
 - 40



N 11 C
 Porta rotolo coperto
 Covered paper holder
 Porte rouleau avec couvercle
 Papierrollenhalter mit Deckel
 Полотенцедержатель с крышкой
 cm 20 L x 11 P x 12 H

- 33 - 39
 - 40



N 11
 Porta rotolo
 Paper holder
 Porte rouleau
 Papierrollenhalter
 Бумагодержатель
 cm 21 L x 9 P x 10 H

- 33 - 39
 - 40



186 GABRI
 Porta scopino d'appoggio in ceramica
 Ceramic toilet brush
 Porte balayent en ceramique
 Bürstengarnitur freistehend aus Keramik
 Напольный керамический ёрш
 cm 13 Ø x 43 H

- 33 - 39
 - 40



N 039
 Porta scopino da appoggio
 Toilet brush with base
 Porte balayent d'appui
 Bürstengarnitur freistehend
 Напольный металлический ёрш
 cm 12,5 Ø x 42 H

- 33 - 39
 - 40



840
 Kit collante e biadesivo per un articolo
 Kit with bi-adhesive and glue for one article
 Kit avec collant et biadhésif pour un article
 Klebekit ist ein beidseitiger Klebestreifen
 Клей



N 07

OPZIONI E COMPLEMENTI / OPZIONI E COMPLEMENTI OPZIONI E COMPLEMENTI / OPZIONI E COMPLEMENTI / OPZIONI E COMPLEMENTI



39



CROMO - CER. BIANCO
 Chrome - Cer. white
 Chrome - Cèr. blanc
 Chrom - Ker. weiß
 хром - белая керамика

40



CROMO - CER. DECORATA
 Chrome - Cer. white, decorated
 Chrome - Cèr. blanc. décoré
 Chrom - Ker. weiß, bemalt
 хром - керамика декорированная

33



CROMO - NOCE SCURO
 Chrome - Dark walnut
 Chrome - Noix sombre
 Chrom - Nußbraun dunkel
 белый - дерево орех

↔ Reversibile su richiesta / Reversible on request / Réversible sur demande / Umkehrbar auf Anfrage / Реверсивный по запросу



Su richiesta si realizzano aste porta asciugamani su misura, 15 gg

Customized towel rails are available on request, 15 days
 Des porte-serviettes personnalisés sont disponibles sur demande, 15 jours
 Handtuchhalter sind auf Anfrage erhältlich, 15 tagen
 По запросу мы можем производить полотенцедержатели под размер 15 дней



- 33 - 39 30 → 42 cm
 - 33 - 39 44 → 100 cm
 - 40 30 → 42 cm
 - 40 44 → 100 cm



> pag. 288

> pag. 298

> pag. 314

> pag. 322

> pag. 347

> pag. 347

> pag. 436

> pag. 318



PRISMA

_ELEGANZA SENZA TEMPO

Designer: Stilhaus
Materiale: ottone, Tubo Ø16, basetta a muro 45x45
Accessori: Ceramica bianca o nera
Finitura: 08-16-25-36
Fuori misura: Sì

Designer: Stilhaus
Material: Brass tube Ø 16, fixing plate cover 45x45
Accessories: White or black ceramic
Finishes: 08-16-25-36
Customized: Yes

Designer: Stilhaus
Matière: Laiton, tuyau Ø 16, boucle couvre-vis 45x45
Accessoires: Blanc or noir céramique
Finitions: 08-16-25-36
Personnalisé: Oui

Designer: Stilhaus
Material: Messing Rohr Ø 16, Befestigungsplatten Oberfläche 45x45
Zubehör: Keramik schwarz oder weiß
Ausführungen: 08-16-25-36
Kundenwunsch: Ja

Разработка дизайна: Stilhaus
Используемый материал: латунь Ø 16, 45x45
Аксессуары: белая или черная керамика
Отделка: 08-16-25-36
Негабаритный: да





PR 18



PR 10
PR 30



PR 45



PR 09
PR 06



PR 04

Mensola vetro 8mm
Shelf
Etagère
Ablage
Стеклопанельная полка - толщина стекла 8mm
cm 75 L x 12 P x 4,5 H - INT. 66

- 08
- 16 - 25 - 36



PR 05

Asta porta asciugamani
Towel rail
Porte serviette
Handtuchhalter
Полотенцедержатель
cm 60 L x 9 P x 4,5 H - INT. 51

- 08
- 16 - 25 - 36



PR 05.2

Porta asciugamani doppia asta
Double towel rail
Porte serviettes avec 2 bars
Doppel Handtuchstange
Полотенцедержатель двойной
cm 60 L x 14 P x 7 H - INT. 51

- 08
- 16 - 25 - 36



PR 45

Asta porta asciugamani
Towel rail
Porte serviette
Handtuchhalter
Полотенцедержатель двойной
cm 50 L x 9 P x 4,5 H - INT. 40

- 08
- 16 - 25 - 36



PR 06

Asta porta salviette
Towel rail
Porte serviettes
Handtuchhalter
Полотенцедержатель двойной поворотный
cm 39 L x 9 P x 4,5 H - INT. 31,50

- 08
- 16 - 25 - 36



PR 16

Porta asciugamani snodo 2 aste
Towel rail with 2 adjustable bar
Porte serviettes à 2 barres orientables
Handtuchhalter schwenkbar 2 Stangen
Полотенцедержатель двойной поворотный
cm 4,5 L x 43 P x 19 H

- 08
- 16 - 25 - 36



PR 18

Porta asciugamani snodo con porta sapone
Towel rail adjustable with soap dish
Porte serviettes orientables avec porte savon
Handtuchhalter schwenkbar mit Seifenschale
Полотенцедержатель двойной поворотный + керамическая мыльница
cm 4,5 L x 43 P x 21 H

- 08
- 16 - 25 - 36



PR 18 D

Porta asciugamani snodo con dosatore
Towel rail adjustable with soap dispenser
Porte serviettes orientables avec porte savon liquid
Handtuchhalter schwenkbar mit Seifenspender
Полотенцедержатель двойной поворотный + керамический дозатор
cm 4,5 L x 43 P x 35 H

- 08
- 16 - 25 - 36



PR 07

Anello porta salviette
Ring serviette holder
Porte serviettes à anneau
Handtuchring
Полотенцедержатель - кольцо
cm 23 L x 9 P x 21 H

- 08
- 16 - 25 - 36



PR 09

Porta sapone a parete
Wall mounted soap dish
Porte savon à mur
Seifenschale wandhängend
Настенная керамическая мыльница
cm 11 L x 12,5 P x 10,5 H

-08bianco/white/blanc/weiß/белый
-16-25-36bianco/white/blanc/weiß
-08nero/black/noir/schwarz/черно
-16-25-36nero/black/noir/schwarz



PR 10

Porta bicchiere a parete
Wall mounted glass holder
Porte verre à mur
Zahnbürstenhalter wandhängend
Настенный керамический стакан
cm 7,5 L x 10,5 P x 17,5 H

-08bianco/white/blanc/weiß/белый
-16-25-36bianco/white/blanc/weiß
-08nero/black/noir/schwarz/черно
-16-25-36nero/black/noir/schwarz



PR 30

Dosatore sapone liquido a parete
Wall mounted soap dispenser
Porte savon liquid à mur
Seifenspender wandhängend
Настенный стеклянный дозатор
cm 7,5 L x 10,5 P x 26 H

-08bianco/white/blanc/weiß/белый
-16-25-36bianco/white/blanc/weiß
-08nero/black/noir/schwarz/черно
-16-25-36nero/black/noir/schwarz



PR 11
PR 039



794

Porta sapone da appoggio
Soap dish with base
Porte savon d'appui
Seifenschale
Настольная керамическая мыльница
cm 10 L x 10 P x 10 H

- bianco / white / blanc / weiß / белый
- nero / black / noir / schwarz / черно



793

Bicchiere da appoggio
Glass with base
Verre d'appui
Zahnputzbecher
Настольный керамический стакан
cm 7,5 L x 7,5 P x 10 H

- bianco / white / blanc / weiß / белый
- nero / black / noir / schwarz / черно



795

Dosatore sapone liquido da appoggio
Liquid soap dispenser
Porte savon liquid
Seifenspender
Настольный керамический дозатор
cm 7,5 L x 7,5 P x 10 H

- 08 bianco / white / blanc / weiß / белый
- 16-25-36 bianco / white / blanc / weiß
- 08 nero / black / noir / schwarz / черно
- 16-25-36 nero / black / noir / schwarz



PR 13

Porta accappatoio (2 ganci)
Robie hook (2 hooks)
Porte peignoir (2 peignoir)
Bademantelhaken (2 Haken)
Крючок двойной
cm 8 L x 9 P x 4,5 H

- 08
- 16 - 25 - 36



PR 11

Porta rotolo
Paper holder
Porte rouleau
Papierrollenhalter
Бумагодержатель
cm 19 L x 9 P x 4,5 H

- 08
- 16 - 25 - 36



PR 11 C

Porta rotolo coperto
Covered paper holder
Porte rouleau avec couvercle
Papierrollenhalter mit Deckel
Бумагодержатель закрытый
cm 20 L x 11 P x 11 H

- 08
- 16 - 25 - 36



PR 796

Porta scopino d'appoggio in ceramica
Ceramic toilet brush
Porte balayent en ceramique
Bürstengarnitur freistehend aus Keramik
Напольный керамический ёрш
cm 10 L x 10 P x 38 H

- 08 bianco / white / blanc / weiß / белый
- 16-25-36 bianco / white / blanc / weiß
- 08 nero / black / noir / schwarz / черно
- 16-25-36 nero / black / noir / schwarz



PR 039

Porta scopino da appoggio
Toilet-brush with base
Porte balayent d'appui
Bürstengarnitur freistehend
Напольный металлический ёрш
cm 8 L x 8,5 P x 41 H

- 08
- 16 - 25 - 36



PR 039 M

Porta scopino a parete
Wall mounted toilet brush
Porte balayent à mur
Bürstengarnitur wandhängend
Настенный металлический ёрш
cm 8 L x 8,5 P x 41 H

- 08
- 16 - 25 - 36



PR 11.11 S

Porta rotolo con scorta
Paper holder with supply
Porte rouleau avec escorte
Papierrollenhalter mit Ersatzhalter
Бумагодержатель двойной
cm 24 L x 9 P x 13 H

- 08
- 16 - 25 - 36



PR 1016

Maniglia per box doccia
Handle for shower enclosure
Poignée pour cabinets de douche
Handgriff für Duschkabinen
Ручка для душевого угла
cm 2 L x 6 P x 26 H-INT. 14

- 08
- 16 - 25 - 36



PR 11 C

OPZIONI E COMPLEMENTI / OPZIONI E COMPLEMENTI OPZIONI E COMPLEMENTI / OPZIONI E COMPLEMENTI

* FINITURA DISPONIBILE IN 20 GG. / Finish available in 20 days / Finition disponible en 20 jours / Oberfläche lieferbar in 20 Tagen / Отделка доступна в течение 20 дней

08	CROMO Chrome Chrome Chrom хром	16*	ORO Gold Or Gold Золото	25*	BRONZO Bronze Bronze Bronze Бронза	36*	NICHEL SATINATO Satin nickel Nickel satiné Nickel satiniert Никель сатин

↔ Reversibile su richiesta / Reversible on request / Réversible sur demande / Umkehrbar auf Anfrage / Реверсивный по запросу

📏 Su richiesta si realizzano aste porta asciugamani su misura, 10 gg

Customized towel rails are available on request, 10 days
Des porte-serviettes personnalisés sont disponibles sur demande, 10 jours
Handtuchhalter sind auf Anfrage erhältlich, 10 Tagen
По запросу мы можем производить полотенцедержатели под размер 10 дней

- 08	30 → 49 cm
- 08	51 → 100 cm
- 16 - 25 - 36	30 → 49 cm
- 16 - 25 - 36	51 → 100 cm

+

> pag. 288	> pag. 308	> pag. 322	> pag. 349	> pag. 349	> pag. 349	> pag. 436

REGAL

_GIUDIZIO REGALE

Designer: Stilhaus
Materiale: Ottone, Tubo Ø 16, basetta a muro Ø 50
Accessori: Vetro Trasparente
Finitura: 08-16-18-25-41
Fuori misura: Sì

Designer: Stilhaus
Material: Brass tube Ø 16, fixing plate cover Ø 50
Accessories: Transparent glass
Finishes: 08-16-18-25-41
Customized: Yes

Designer: Stilhaus
Matière: Laiton, tuyau Ø 16, boucle couvre-vis Ø 50
Accessoires: Verre transparent
Finitions: 08-16-18-25-41
Personnalisé: Oui

Designer: Stilhaus
Material: Messing Rohr Ø 16, Befestigungsplatten Oberfläche Ø 50
Zubehör: Klarglas
Ausführungen: 08-16-18-25-41
Kundenwunsch: Ja

Дизайн: Stilhaus
Материал: латунь Ø 16, Ø 50
Аксессуары: прозрачное стекло
Отделка: 08-16-18-25-41
Негабаритный: да







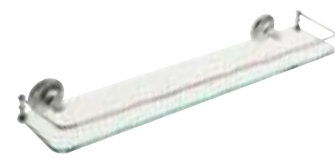

RG 04

Mensola vetro 8mm
Shelf
Etegerè
Ablage
Стеклопанельная полка - толщина стекла 8mm
cm 60 L x 13 P x 7 H

• 08
• 16 - 25



RG 05

Asta porta asciugamani
Towel rail
Porte serviette
Handtuchhalter
Полотенцедержатель
cm 64 L x 9 P x 7 H - INT. 58

• 08
• 16 - 25
• 41 Maggiorazione
• VET Maggiorazione



RG 45

Asta porta asciugamani
Towel rail
Porte serviette
Handtuchhalter
Полотенцедержатель
cm 45 L x 9 P x 7 H - INT. 39

• 08
• 16 - 25
• 41 Maggiorazione
• VET Maggiorazione



RG 06

Asta porta salviette
Ring towel serviette
Porte serviettes anneau
Handtuchring
Полотенцедержатель
cm 37,5 L x 9 P x 7 H - INT. 31

• 08
• 16 - 25
• 41 Maggiorazione
• VET Maggiorazione



1130

Porta bicchiere da appoggio
Glass holder with base
Porte verre d'appui
Zahnbrüstenhalter freistehend
Настольный стеклянный стакан
cm 6 Ø x 14 H

• 08
• 16 - 25



1131

Dosatore sapone liquido da appoggio
Soap dispenser with base
Porte savon d'appui
Seifenspender freistehend
Настольный стеклянный дозатор
cm 6 Ø x 19 H

• 08
• 16 - 25



RG 13.1

Porta accappatoio
Robie hook
Porte peignoir
Bademantelhaken
Крючок двойной
cm 9 L x 8,5 P x 7 H

• 08
• 16 - 25
• 41 Maggiorazione
• VET Maggiorazione



RG 13.2

Porta accappatoio (2 ganci)
Robie hook (2 hooks)
Porte peignoir (2 peignoir)
Bademantelhaken (2 Haken)
Крючок двойной
cm 6 L x 8,5 P x 6 H

• 08
• 16 - 25
• 41 Maggiorazione
• VET Maggiorazione



RG 16

Porta asciugamani snodo 2 aste
Towel rail with 2 adjustable bar
Porte serviettes à 2 barres orientables
Handtuchhalter schwenkbar 2 Stangen
Полотенцедержатель двойной поворотный
cm 43 L x 43 P x 19 H

• 08
• 16 - 25
• 41 Maggiorazione
• VET Maggiorazione



RG 07

Anello porta salviette
Ring towel serviette
Porte serviettes anneau
Handtuchring
Полотенцедержатель - кольцо
cm 23,5 L x 8 P x 16 H

• 08
• 16 - 25
• 41 Maggiorazione
• VET Maggiorazione



RG 79

Anello porta salviette con porta sapone
Ring serviette holder with soap holder
Porte serviettes à anneau avec porte savon
Handtuchring mit Seifenschale
Полотенцедержатель - полукольцо +
стеклянная мыльница
cm 30 L x 10 P x 16H

• 08
• 16 - 25
• 41 Maggiorazione
• VET Maggiorazione



RG 79 D

Anello porta salviette con dosatore sapone
Ring serviette holder with soap dispenser
Porte serviettes à anneau avec porte savon liquid
Handtuchring mit Seifenspender
Полотенцедержатель - полукольцо +
стеклянный дозатор
cm 30 L x 9 P x 22 H

• 08
• 16 - 25
• 41 Maggiorazione
• VET Maggiorazione



RG 11

Porta rotolo
Paper holder
Porte rouleau
Papierrollenhalter
Бумагодержатель
cm 20,5 L x 9 P x 12 H

• 08
• 16 - 25
• 41 Maggiorazione
• VET Maggiorazione



RG 11 C

Porta rotolo con coperchio
Covered paper holder
Porte rouleau avec couvercle
Papierrollenhalter mit Deckel
Бумагодержатель с крышкой
cm 20,5 L x 14 P x 9 H

• 08
• 16 - 25
• 41 Maggiorazione
• VET Maggiorazione



RG 039

Porta scopino
Toilet-brush
Porte balayent
Bürstengarnitur
Напольный металлический ёрш
cm 12,5 Ø x 41,5 H

• 08
• 16 - 25
• 41 Maggiorazione
• VET Maggiorazione



RG 039 M

Porta scopino a parete
Wall mounted toilet brush
Porte balayent à mur
Bürstengarnitur wandhängend
Настенный металлический ёрш
cm 8 L x 8,5 P x 41 H

• 08
• 16 - 25
• 41 Maggiorazione
• VET Maggiorazione

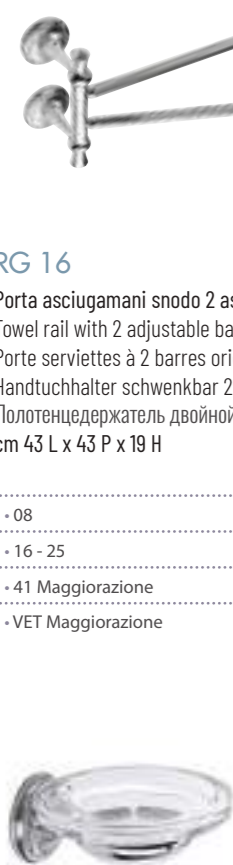

RG 09

Porta sapone a parete
Wall-mounted soap dish
Porte savon à mur
Seifenschale
Настенная стеклянная мыльница
cm 12,5 L x 15,5 P x 7 H

• 08
• 16 - 25



RG 10

Porta bicchiere a parete
Wall mounted glass holder
Porte verre à mur
Zahnbrüstenhalter wandhängend
Настенный стеклянный стакан
cm 8 L x 13,5 P x 12 H

• 08
• 16 - 25



RG 30

Dosatore sapone liquido a parete
Wall mounted liquid soap dispenser
Doseur de savon liquid à mur
Seifenspender wandhängend
Настенный стеклянный дозатор
cm 7,5 L x 13,5 P x 19 H

• 08
• 16 - 25



RG 09 AP

Porta sapone da appoggio
Soap dish with base
Porte savon d'appui
Seifenschale freistehend
Настольная стеклянная мыльница
cm 12,5 Ø x 2 H

• 08
• 16 - 25

OPZIONI E COMPLEMENTI / OPZIONI E COMPLEMENTI / OPZIONI E COMPLEMENTI / OPZIONI E COMPLEMENTI



* FINITURA DISPONIBILE IN 20 GG. / Finish available in 20 days / Finition disponible en 20 jours / Oberfläche lieferbar in 20 Tagen / Отделка доступна в течение 20 дней

08 CROMO
Chrome
Chrom
хром



16* ORO
Gold
Or
Gold
Золото



18* ORO OPACO
Matt gold
L'or mat
Mattes Gold
матовое золото



25 BRONZO
Bronze
Bronze
Бронза



VET CRISTALLO
Crystal
Cristal
Kristall
Кристалл



41 MARMO
Marble
Marbre
Marmor
Мрамор



Reversibile su richiesta / Reversible on request / Réversible sur demande / Umkehrbar auf Anfrage / Реверсивный по запросу

SMART

_FUNZIONE GLOBALE

Designer: Stilhaus
Materiale: Ottone, Tubo Ø 16 , basetta a muro Ø 45
Accessori: Ceramica bianca
Finitura: 08-02-25
Fuori misura: Sì

Designer: Stilhaus
Material: Brass tube Ø 20, fixing plate cover Ø 45
Accessories: White ceramic
Finishes: 08-02-25
Customized: Yes

Designer: Stilhaus
Matière: Laiton, tuyau Ø 16, boucle couvre-vis Ø 45
Accessoires: Blanc céramique
Finitions: 08-02-25
Personnalisé: Oui

Designer: Stilhaus
Material: Messing Rohr Ø 16, Befestigungsplatten Oberfläche Ø 45
Zubehör: Weiße Keramik
Ausführungen: 08-02-25
Kundenwunsch: Ja

Разработка дизайна: Stilhaus
Используемый материал: латунь Ø 16, Ø 45
Аксессуары: белая керамика
Отделка: 08-02-25
Негабаритный: да





SM 09



SM 45



SM 11



SM 10



SM 04

Mensola vetro 8 mm
Shelf
Etagère
Ablage
Стеклоянная полка - толщина стекла 8mm
cm 60 L x 15 P x 5 H

- 08
- 02
- 25



SM 05

Asta porta asciugamani
Towel rail
Porte serviette
Handtuchhalter
Полотенцедержатель
cm 57 L x 7 P x 5 H - INT.49,5

- 08
- 02
- 25



SM 45

Asta porta asciugamani
Towel rail
Porte serviette
Handtuchhalter
Полотенцедержатель
cm 44 L x 7 P x 5 H - INT.37,5

- 08
- 02
- 25



SM 06.2

Asta porta salviette
Towel rail
Porte serviette
Handtuchhalter
Полотенцедержатель
cm 34 L x 7 P x 5 H - INT.28

- 08
- 02
- 25



SM 11 C

Porta rotolo coperto
Covered paper holder
Porte rouleau avec couvercle
Papierrollenhalter mit Deckel
Бумагодержатель закрытый
cm 18 L x 10 P x 15 H

- 08
- 02
- 25



SM 039M

Porta scopino a parete
Wall-mounted toilet-brush
Porte balayent à mur
Bürstengarnitur wandhängend
Настенный металлический ёрш
cm Ø 8,5 x 36 H

- 08
- 02
- 25



SM 039

Porta scopino da appoggio
Toilet brush with base
Porte balayent d'appui
Bürstengarnitur freistehend
Напольный металлический ёрш
cm Ø 8,5 x 36 H

- 08
- 02
- 25



185

Porta asciugamani snodo 2 aste
Towel rail with 2 adjustable bar
Porte serviettes à 2 barres orientables
Handtuchhalter schwenkbar 2 Stangen
Полотенцедержатель двойной поворотный
cm 36 L x 4 P x 13 H

- 08
- 02
- 25



SM 07

Anello porta salviette
Ring serviette holder
Porte serviettes à anneau
Handtuchring
Полотенцедержатель - кольцо
cm 20,5 L x 7,5 P x 22 H

- 08
- 02
- 25



SM 09

Porta sapone a parete
Wall mounted soap dish
Porte savon à mur
Seifenschale wandhängend
Настенная керамическая мыльница
cm 15 L x 13 P x 6 H

- 08
- 02
- 25



SM 10

Porta bicchiere a parete
Wall mounted glass holder
Porte verre à mur
Zahnbürstenhalter wandhängend
Настенный керамический стакан
cm 9 L x 13 P x 10 H

- 08
- 02
- 25

OPZIONI E COMPLEMENTI / OPZIONI E COMPLEMENTI OPZIONI E COMPLEMENTI / OPZIONI E COMPLEMENTI / OPZIONI E COMPLEMENTI



08



CROMO
Chrome
Chrome
Chrom
хром

02



CROMO - ORO
Chrome - Gold
Chrome - Or
Chrom - Gold
Хром - золото

25



BRONZO
Bronze
Bronze
Bronze
Бронза



Su richiesta si realizzano aste porta asciugamani su misura, 10 gg

Customized towel rails are available on request, 10 days
Des porte-serviettes personnalisés sont disponibles sur demande, 10 jours
Handtuchhalter sind auf Anfrage erhältlich, 10 tagen
По запросу мы можем производить полотенцедержатели под размер 10 дней



- 08 28 → 43 cm
- 08 45 → 100 cm
- 02 28 → 43 cm
- 02 45 → 100 cm
- 25 28 → 43 cm
- 25 45 → 100 cm



SM 30

Dosatore sapone a parete
Wall mounted soap dispenser
Porte savon liquid à mur
Seifenspender wandhängend
Настенный дозатор
cm 9 L x 13 P x 18 H

- 08
- 02
- 25



SM 13

Porta accappatoio (2 ganci)
Robie hook (2 hooks)
Porte peignoir (2 peignoir)
Bademantelhaken (2 Haken)
Крючок двойной
cm 11 L x 7 P x 5 H

- 08
- 02
- 25



SM 13.1

Porta accappatoio singolo
Robe hook
Porte peignoir
Bademantelhaken
Крючок
cm 5 L x 6,5 P x 5 H

- 08
- 02
- 25



SM 11

Porta rotolo
Paper holder
Porte rouleau
Papierrollenhalter
Бумагодержатель
cm 17 L x 7 P x 5 H

- 08
- 02
- 25



> pag. 288



> pag. 314



> pag. 322



> pag. 433



> pag. 322



> pag. 318

SMART LIGHT

_LUCE A SORPRESA

Designer: Stilhaus
Materiale: ottone, Tubo Ø 16, basetta a muro Ø 45
Accessori: Vetro trasparente
Finitura: 08-16-25
Fuori misura: Sì

Designer: Stilhaus
Material: Brass tube Ø 16, fixing plate cover Ø 45
Accessories: Transparent glass
Finishes: 08-16-25
Customized: Yes

Designer: Stilhaus
Matière: Laiton, tuyau Ø 16, boucle couvre-vis Ø 45
Accessoires: Verre transparent
Finitions: 08-16-25
Personnalisé: Oui

Designer: Stilhaus
Material: Messing Rohr Ø 16, Befestigungsplatten Oberfläche Ø 45
Zubehör: Klarglas
Ausführungen: 08-16-25
Kundenwünsche: Ja

Разработка дизайна: Stilhaus
Используемый материал: латунь Ø 16, Ø 45
Аксессуары: прозрачное стекло
Отделка: 08-16-25
Негабаритный: да





SL 45



SL 07



SL 11 16



SL 09
SL 30



SL 04

Mensola vetro 8mm
Shelf
Etagère
Ablage
Стеклопанельная полка - толщина стекла 8mm
cm 70 L x 13 P x 5 H - INT. 67

- 08
- 16 - 25



SL 05 

Asta porta asciugamani
Towel rail
Porte serviettes
Handtuchhalter
Полотенцедержатель
cm 62 L x 7 P x 5 H - INT. 49,5

- 08
- 16 - 25



SL 45

Asta porta asciugamani
Towel rail
Porte serviettes
Handtuchhalter
Полотенцедержатель
cm 45 L x 7 P x 5 H - INT. 37,5

- 08
- 16 - 25



SL 06

Asta porta salviette
Towel rail
Porte serviettes
Handtuchhalter
Полотенцедержатель
cm 39 L x 7 P x 5 H - INT. 28

- 08
- 16 - 25



SL 11 C

Porta rotolo coperto
Covered paper holder
Porte rouleau avec couvercle
Papierrollenhalter mit Deckel
Бумагодержатель закрытый
cm 19 L x 7 P x 5 H

- 08
- 16 - 25



SL 039 M

Porta scopino a parete
Wall mounted toilet-brush
Porte balaynet à mur
Bürstengarnitur wandhängend
Настенный металлический ёрш
cm 8,5 Ø x 38 H

- 08
- 16 - 25



SL 039

Porta scopino da appoggio
Toilet-brush with base
Porte balaynet d'appui
Bürstengarnitur freistehend
Напольный металлический ёрш
cm 12,5 Ø x 38 H

- 08
- 16 - 25



SL 1016

Maniglia per box doccia
Handle for shower enclosure
Poignée pour cabinets de douche
Handgriff für Duschkabinen
Ручка для душевого угла
cm 3 L x 6 P x 24 H - INT. 14

- 08
- 16 - 25



SL 16

Porta asciugamani snodo 2 aste
Towel rail with 2 adjustable bar
Porte serviettes à 2 barres orientables
Handtuchhalter schwenkbar 2 Stangen
Полотенцедержатель двойной поворотный
cm 4 L x 4/35 P x 9 H

- 08
- 16 - 25



SL 07

Anello porta salviette
Ring serviette holder
Porte serviettes à anneau
Handtuchring
Полотенцедержатель - кольцо
cm 20,5 L x 10 P x 25 H

- 08
- 16 - 25



SL 09

Porta sapone a parete
Wall mounted soap dish
Porte savon à mur
Seifenschale wandhängend
Настенная керамическая мыльница
cm 12 L x 13 P x 12 H

- 08
- 16 - 25



SL 10

Porta bicchiere a parete
Wall mounted glass holder
Porte verre à mur
Zahnbürstenhalter wandhängend
Настенный керамический стакан
cm 9 L x 12 P x 18 H

- 08
- 16 - 25



1269

Porta sapone da appoggio in cristallo
Crystal countertop soap dish
Porte-savon de comptoir en cristal
Seifenschale aus Kristall für die Arbeitsplatte
Хрустальная мыльница для столешницы
cm Ø 15 x 4 H

- TR



1270

Porta bicchiere da appoggio in cristallo
Crystal glass holder
Porte-verre en cristal
Kristallglashalter
Держатель из хрустального стекла
cm Ø 7,5 x 10 H

- TR



1271

Dosatore sapone liquido da appoggio in cristallo
Crystal liquid soap dispenser
Distributeur de savon liquide cristal de comptoir
Tischspender für Flüssigseife aus Kristall
Настольный кристаллический дозатор для жидкого мыла
cm Ø 7,5 x 15 H

- TR / 08
- TR / 16 - 25



SL 30

Dosatore sapone a parete
Wall mounted soap dispenser
Porte savon liquide à mur
Seifenspender wandhängend
Настенный дозатор
cm 12 L x 13 P x 21 H

- 08
- 16 - 25



SL 15

Porta sapone + Porta bicchiere da appoggio
Soap dish + Glass holder
Porte savon + Porte verre
Seifenschale + Zahnbürstenhalter freistehend
Настольная мыльница + стакан
cm Ø 12,5 x 25 L x 18 H

- 08
- 16 - 25



SL 13

Porta accappatoio
Robe hook
Porte peignoir
Bademantelhaken
Крючок
cm 5 L x 7 P x 11 H

- 08
- 16 - 25



SL 11

Porta rotolo
Paper holder
Porte rouleau
Papierrollenhalter
Бумагодержатель
cm 5 L x 7 P x 11 H

- 08
- 16 - 25

OPZIONI E COMPLEMENTI / OPZIONI E COMPLEMENTI / OPZIONI E COMPLEMENTI / OPZIONI E COMPLEMENTI / OPZIONI E COMPLEMENTI



08



CROMO
Chrome
Chrome
Chrom
хром

16



ORO
Gold
Or
Gold
Золото

25



BRONZO
Bronze
Bronze
Bronze
Бронза



Su richiesta si realizzano aste porta asciugamani su misura, 20 gg

Customized towel rails are available on request, 20 days
Des porte-serviettes personnalisés sont disponibles sur demande, 20 jours
Handtuchhalter sind auf Anfrage erhältlich, 20 tagen
По запросу мы можем производить полотенцедержатели под размер 20 дней



- 08 30 → 44 cm
- 08 46 → 100 cm
- 16 - 25 30 → 44 cm
- 16 - 25 46 → 100 cm

SOLUZIONI D'ARREDO

_FORME E FUNZIONI

Designer: Stilhaus, Settimelli, Lenarda, Paludi, Talocci, Pallocca
Fuori misura: Sì
*IMBALLI: per questi articoli si provvederà al recupero di €10,00 a spedizione

Designer: Stilhaus, Settimelli, Lenarda, Paludi, Talocci, Pallocca
Customized: Yes
PACKAGING: for these items you we will add €10.00 for shipment

Designer: Stilhaus, Settimelli, Lenarda, Paludi, Talocci, Pallocca
Personnalis : Oui
EMBALLAGE: pour cette articles nous allons debiter €10,00 en facture

Designer: Stilhaus, Settimelli, Lenarda, Paludi, Talocci, Pallocca
Kundenwunsche: Ja
Verpackungen: f r den Versand berechnen wir Ihnen 10   extra

Разработка дизайна: Stilhaus, Settimelli, Lenarda, Paludi, Talocci, Pallocca
Негабаритный: да



1263

Specchio sagomato con LED
Cut mirror with LED
Miroir coupé avec LED
Geformter Spiegel mit LED
Декоративное зеркало
cm Ø 70

• LED

TT 1280

Struttura porta lavabo con porta asciugamani
Support with towelholder
Structure avec porte serviette
Struktur mit Handtuchhalter
Структура с полотенцем
cm 50 L x 40 P x 74 H

• 08 - 03 - 05

• 36

1282

Lavabo in ceramica
Ceramic washbasin
Lavabo en céramique
Keramik Aufsatzwaschbecken
Керамическая раковина
cm 50 L x 41 P x 14 H

• 01

TT 04

Maniglione di sicurezza in ottone cm 80
Brass safety handle cm 80
Poignée de sécurité en laiton cm 80
Sicherheitsgriff aus Messing cm 80
Латунная предохранительная ручка cm 80
cm 80,5 L x 8 P x 3 H

• 08

TT 15

Mensola 2 fori plexiglass per barra orizzontale
2-hole plexiglass shelf for horizontal bar
Tablette en plexiglas à 2 trous pour barre horizontale
2-Loch-Plexiglasablage für Reckstange
Полка из оргстекла с 2 отверстиями для горизонтальной штанги
cm 20 L x 14 P x 6 H

•

TT 1205

Bicchieri in Neolite per Totem
Neolite glass for Totem
Verre de néolite pour Totem
Neolithglas für Totem
Неолитовое стекло для Тотема
cm Ø 7,5 x 13 H

• BI

TT 1206

Dosatore in Neolite per Totem
Neolite dispenser for Totem
Distributeur de néolite pour Totem
Neolith-Spender für Totem
Неолитовый дозатор для Totem
cm Ø 7,5 x 17 H

• BI - 08

228_SOLUZIONI D'ARREDO



LV 01

Specchio sagomato
Cut mirror
Miroir coupé
Geformter Spiegel
Декоративное зеркало
cm 50 L x 90 H
CE: LED - 26 W - V220 - IP21

• LED

TT 1281

Struttura porta lavabo in ottone con mensola in vetro
Brass support with glass shelf
Support avec glass étagère
Waschtischkonsole aus Messing mit Glasablage
Каркас из хромированной латуни со стеклянной полкой
cm 50 L x 41 P x 74 H

• 08 - 03 - 05

• 36

1282

Lavabo in ceramica
Ceramic washbasin
Lavabo en céramique
Keramik Aufsatzwaschbecken
Керамическая раковина
cm 50 L x 41 P x 14 H

• 01

TT 1283

Maniglione di sicurezza reclinabile
Brass safety handle cm 80
Poignée de sécurité en laiton cm 80
Sicherheitsgriff aus Messing cm 80
Латунная предохранительная ручка cm 80
cm 80,5 L x 8 P x 3 H

• 08

TT 03

Maniglione di sicurezza in ottone cm 60
Brass safety handle cm 60
Poignée de sécurité en laiton cm 60
Sicherheitsgriff aus Messing cm 60
Латунная предохранительная ручка cm 60
cm 60,5 L x 8 P x 3 H

• 08

TT 14

Mensola 1 foro plexiglass per barra orizzontale
Plexiglass shelf 1 hole for horizontal bar
Étagère en plexiglas 1 trou pour barre horizontale
Plexiglasboden 1 Loch für Reckstange
Полка из оргстекла 1 отверстие для горизонтальной штанги
cm 10 L x 14 P x 6 H

•

TT 1206

Dosatore in Neolite per Totem
Neolite dispenser for Totem
Distributeur de néolite pour Totem
Neolith-Spender für Totem
Неолитовый дозатор для Totem
cm Ø 7,5 x 17 H

• NE - 08



1208

Specchio sagomato
Cut mirror
Miroir coupé
Geformter Spiegel
Декоративное зеркало
cm 86 L x 86 H

• CE: LED - 13 W - V220 - IP21

1209

Specchio ingranditore 3x con calamita
Enlarging mirror 3x with magnet
Miroir agrandisseur 3x avec aimant
Wandspiegel Vergrößerung 3x mit Magnet
3-кратное увеличительное зеркало с магнитом
cm Ø 14 x 10 P

• 08

1214

Struttura porta lavabo in ottone con mensola in legno
Brass support with wook shelf
Support avec étagère en bois
Waschbeckenhalterung aus Messing mit Holzablage
Латунная конструкция держателя умывальника с деревянной полкой
cm 60 L x 48 P x 77 H

• 08 - 23 - 24

• 18 - 56

830

Lavabo in ceramica tondo
Round ceramic washbasin
Lavabo ronde en céramique
Keramik Aufsatzwaschbecken rund
Круглая керамическая раковина
cm 40 Ø x 15 H

• BI

RAC 393

Sifone tornito in ottone cromato 1" ¼
Chromed brass si phon 1" ¼
Siphon en laiton chromé 1" ¼
Siphon aus verchromtem Messing 1" ¼
Хромированный сифон 1" ¼



830 BI
Ceramica - Bianco
Ceramic - White
Ceramique - Blanc
Keramik - Weiß
Керамика - белый

842

Specchio Retroilluminato LED, con cornice nera
Mirror with LED light, black aluminium frame
Miroir avec LED lumière, cadre en aluminium noir
Spiegel mit LED Hinterleuchtung und Halterung
aus schwarz
зеркало со светодиодной подсветкой и черной
рамкой

cm 60 L x 90 H

CE: LED - 9W - V220 - IP21

• 08 - 23

1214

Struttura porta lavabo in ottone con mensola
in legno
Brass support with wook shelf
Support avec étagère en bois
Waschbeckenhalterung aus Messing mit
Holzablage
Waschbeckenhalterstruktur aus Messing mit
Holzablage
cm 60 L x 48 P x 77 H

• 08 - 23 - 24

• 18 - 56

1036

Specchio ingranditore 4x da parete con
illuminazione LED
Wall monde enlarging mirror 4x with LED light
Miroir agrandisseur à mur 4x avec LED
Schwenkbarer Wand-Vergrößerungsspiegel 4x
Настенное косметическое зеркало с 4-х
кратным увеличением и подсветкой
cm Ø 22 x 40P Max H22 • Base Ø 12,5
CE : V 220 12V 4W

• 08

• 26 - 16 - 36 - 23

RAC 393

Sifone tornito in ottone cromato 1" ¼
Chromed brass si phon 1" ¼
Siphon en laiton chromé 1" ¼
Siphon aus verchromtem Messing 1" ¼
Хромированный сифон 1" ¼

• 08

• 23



1308

Specchio retroilluminato, luce cost to cost
 Mirror with led light cost to cost
 Miroir avc led lumiere cost to cost
 Hinterleuchteter Spiegel, Kosten für Licht
 Зеркало с подсветкой, стоимость света
 cm 50 L x 90 H
 CE: Led 10 W - V 220 - IP21

RL 29.70

Struttura porta lavabo in ottone
 Top brass support
 Support en lation for plan
 Waschtischhalterung aus Messing
 Латунная конструкция держателя умывальника
 cm 70 L x 50 P x 83 H

• 08 - 10 - 23
 • 36

RL 28.70

Piano con lavabo integrato in ocritech
 Ocritech top with washbasin
 Plan en ocritech avec lavabo
 Platte mit integriertem Ocritech-Waschbecken
 Top со встроенным умывальником Ocritech
 cm 70 L x 50 P

• 01

SOL 11 cm 130 L

• 08 - 10 - 23
 • 36
 • Legno / Ocritech
 • Marmo Bianco



852

Base inox con ruote, 4 cassetti
 Unit on wheels with 4 drawers
 Armoire d'appoint inox sur roulettes, 4 tiroirs
 Rollenschrank aus Edelstahl, 4 Schubladen
 Передвижная банкетка с 4-мя
 выдвижными ящиками
 cm 35 L x 30 P x 81 H

853

Base inox con ruote, 2 cassetti, 1 anta vetro
 Two drawers + one door on wheels
 Armoire d'appoint inox sur roulettes, 2 tiroirs,
 1 porte en verre
 Rollenschrank aus Edelstahl, 2 Schubladen
 und 1 Glasür
 Передвижная банкетка с 2-мя выдвижными
 ящиками и 1-й стеклянной распашной
 дверцей
 cm 35 L x 30 P x 81 H

854

Base inox con ruote, 1 cassetto, 1 anta vetro
 One drawer + one door on wheels
 Armoire d'appoint inox sur roulettes, 1 tiroir,
 1 porte en verre
 Rollenschrank aus Edelstahl, 1 Schubladen
 und 1 Glasür
 Передвижная банкетка с 1-м выдвижным
 ящиком и 1-й стеклянной распашной
 дверцей
 cm 35 L x 30 P x 81 H

850

Colonna rotante inox con specchio
 Stainless steel turning cabinet with mirror
 Armoire tournant en inox avec mirror
 Drehbarer Spiegel mit Edelstahlstange
 Поворотная колонна на ножке с зеркалом
 cm 25 L x 15 P x 165 H



EQUILIBRIUM MARMO Designer Gianluca Paludi

1285

Specchio retroilluminato con punti led
Backlit mirror with LED dots
Miroir rétro-éclairé avec points LED
Hintergrundbeleuchteter Spiegel mit LED-Punkten
Зеркало с подсветкой и светодиодными точками
cm Ø 80

CE: LED - 15 W - V220 - IP21

1286

Struttura porta lavabo con porta asciugamani
Support with towelholder
Structure avec porte serviette
Struktur mit Handtuchhalter
Структура с полотенцем
cm 50 L x 40 P x 74 H

• 08 - 23

• 18 - 36

• 17

1282

Lavabo in ceramica
Ceramic washbasin
Lavabo en céramique
Keramik Aufsatzwaschbecken
Керамическая раковина
cm 50 L x 41 P x 14 H

• 01

EQM 05

Asta porta salviette
Towel rail
Porte serviettes
Handtuchhalter
Полотенцедержатель
cm 50 L x 7 P x 5 H

• 08 - 23

• 18 - 36

• 17

1242

Piantana: porta rotolo e porta salviette
Free-standing upright: paper holder and Towel rail
Sur pied : porte-rouleau de papier toilette et porte-serviette
Stehleuchte: Toilettenpapier- und Handtuchhalter
Напольный светильник: держатель для туалетного рулона и полотенца
cm Ø 12 x 80 H

• 08 - 23

• 18 - 36

• 17

RAC 393

Sifone tornito in ottone cromato 1" ¼
Chromed brass si phon 1" ¼
Siphon en laiton chromé 1" ¼
Siphon aus verchromtem Messing 1" ¼
Хромированный сифон 1" ¼

• 08

• 16 - 25 - 26

234_SOLUZIONI D'ARREDO



LUI & LEI

895 [design Massimiliano Settimelli]

LUI specchio sagomato filo lucido
LUI cut mirror with shine edge
LUI miroir coupé avec bord brillant
LUI geformter Spiegel mit glänzendem Rand
Зеркало в виде мужского лица
cm 76 L x 65 H

896 [design Massimiliano Settimelli]

LEI specchio sagomato filo lucido
LEI cut mirror with shine edge
LEI miroir coupé avec bord brillant
LEI geformter Spiegel mit glänzendem Rand
Зеркало в виде женского лица
cm 76 L x 65 H

913 [design Massimiliano Settimelli]

NUVOLA applique
NUVOLA applique
NUVOLA applique
NUVOLA Wandleuchte
Настенный светильник в виде облака
cm 25 L x 8 P x 20 H
CE : V 220/12v IP20 G9 35Wx2

• 08 € 160,00

Piano in legno idrorepellente bianco, tortora, rovere
Waterproof wood top
Plan en bois imperméable
Wasserabweisende Holzplatte
Столешница из дерева с водоталкивающим покрытием

892 cm 70Lx50Px12H

893 cm 90Lx50Px12H

894 cm 120Lx50Px12H

897

Staffe porta lavabo
Support for wood top
Supports pour plan en bois
Waschtischkonsolen
Кронштейны для столешницы
cm 5 L x 30 P x 10 H

• 01

830

Lavabo in ceramica tondo
Round ceramic washbasin
Lavabo ronde en céramique
Keramik Aufsatzwaschbecken rund
Круглая керамическая раковина
cm 40 Ø x 15 H

• BI



BI

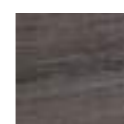

TO



RO



830 BI
Ceramica - Bianco
Ceramic - White
Céramique - Blanc
Keramik - Weiß
Керамика - белый

EQUILIBRIUM OTTONE

1118

Specchio con LED perimetrale
Mirror with diffused led light
Miroir avec led lumière diffusée
Spiegel mit LED Hinterleuchtung
Зеркало со светодиодом по периметру
cm Ø 70

CE: Led 26 W - V 220 - IP21

1245 SP

Applique LED per specchio
LED wall light for mirror
Applique LED pour miroir
LED-Wandleuchte für Spiegel
Светодиодный настенный светильник для зеркала
cm 10 L x 15 P x 5 H

CE: V 220/12v IP44 G9 3W 3000K

1092

Specchio ingranditore 3x tondo a parete
Wall mounted round enlarging mirror 3x
Miroir agrandisseur 3x round à mur
Runde Wandspiegel mit Vergrößerung 3x
Настенное косметическое зеркало с 3-х
кратным увеличением

cm Ø 20 x 8/18 P • Base Ø 5 x 1 H

• 08 - 23

812

Vasca di vetro con ghiera di fissaggio
Glass washbasin with fixing ring
Lavabo en verre avec anneau de fixation
Glas Aufsatzwaschbecken rund mit Distanzring
Стеклянная раковина матовая

cm 37 Ø x 17 H

• Satinato/satin/satin/satiniert/Хром

813

Supporto in acciaio con foro rubinetteria
Stainless steel wall bearing with hole for tap
Support en acier inox avec trou pour robinet
Wandhalterung aus Edelstahl für Glaswasch-
becken mit Loch

Настенный фиксатор для сифона

cm 32 P x 10 L x 10 H fori Ø 4,5/3,2

RAC 488

Piletta di scarico lavabo Up&Down 1" ¼

Washbasin drain Up&Down 1" ¼

Vidage Up&Down pour lavabo 1" ¼

Ablaufventil Up&Down 1" ¼

Дренажного отверстия умывальник вверх и вниз 1 ¼"

cm 6 H

RAC 393

Sifone tornito in ottone cromato 1" ¼

Chromed brass si phon 1" ¼

Siphon en laiton chromé 1" ¼

Siphon aus verchromtem Messing 1" ¼

Хромированный сифон 1 ¼"

Designer Gianluca Paludi



Blu satinato
Blue satin
Satin bleu
Blau satiniert
синий сатин



Rosso satinato
Red satin
Satin rouge
Rot satiniert
красный сатин



Arancio satinato
Orange satin
Satin oranger
Orange satiniert
красный сатин



Bianco satinato
White satin
Satin blanc
Weiß satiniert
Белая атласная



Verde satinato
Green satin
Satin vert
Grün satiniert
зеленый сатин

KREA

550

Specchio con contenitore in acciaio inox
Mirror with container in stainless steel
Miroir avec conteneur en acier inox
Spiegelschrank Edelstahl
Зеркальный шкаф из нержавеющей стали
cm Ø 60 x 14 P

• filolucido/shineedge/bordbrillant/
glänzender Rand / провод полированный

502

Applique con 2 lampade alogene e trasformatore
Applique with 2 halogen lamps and transformer
Applique avec 2 lampes halogène et transformateur
Wandleuchte mit 2 Halogenlampen und Trafo
2 галогеновые лампы и трансформатор
cm 6 L x 2,5 P

CE: V 220/12v IP20 G4 20Wx2

812

Vasca di vetro con ghiera di fissaggio
Glass washbasin with fixing ring
Lavabo en verre avec anneau de fixation
Glas Aufsatzwaschbecken rund mit Distanzring
Стеклянная раковина

cm 37 Ø x 17 H

• Satinato/satin/satin/satiniert/Хром

• Colorato/colored/coloré/farbig/цветной

814

Supporto in acciaio inox senza foro rubinetteria
Stainless steel wall bearing without hole for tap
Support en acier inox sans trou pour robinet
Wandhalterung aus Edelstahl für Glaswasch-
becken ohne Loch

Настенный фиксатор для сифона

cm 30 P x 10 L x 10 H foro Ø 4,5

RAC 488

Piletta di scarico lavabo Up&Down 1" ¼

Washbasin drain Up&Down 1" ¼

Vidage Up&Down pour lavabo 1" ¼

Ablaufventil Up&Down 1" ¼

Дренажного отверстия умывальник вверх и

вниз 1 ¼"

cm 6 H

RAC 393

Sifone tornito in ottone cromato 1" ¼

Chromed brass si phon 1" ¼

Siphon en laiton chromé 1" ¼

Siphon aus verchromtem Messing 1" ¼

Хромированный сифон 1 ¼"

QUEEN

Dalla polvere al cristallo

Una miscela di granelli fonde a 1400°, riposa per ore fino all'azione delle canne da levata dei maestri vetrai che estraggono l'impasto, lo soffiano fino alle pareti dello stampo. Nasce la forma che renderà ogni oggetto simile, ma non uguale.

Prima temperato per la prima severa selezione di qualità, poi sottoposto alla lavorazione a freddo.

Nel cristallo, rispetto al vetro, vi è l'ossido di piombo che conferisce una rifrazione della luce che si avvicina alle proprietà ottiche del diamante ed una malleabilità del manufatto che ne permette l'incisione.

Sono quindi i molatori che segano, nastrano, forano, levigano il pezzo; a loro volta i maestri incisori con le mole diamantate realizzano le decorazioni e le sfaccettature alleate della lucentezza e della duttilità.



From dust to crystal

A mixture of grains melts at 1400°, rests until the glass masters who extract the mixture blow it up to the walls of the mold.

Form is born and it will make every object similar, but not the same.

The crystal is first tempered for the first strict quality selection, then subjected to cold working.

In the crystal, compared to glass, there is lead oxide which gives a refraction of light that is close to the optical properties of the diamond and a malleability that allows it to be engraved.

The master grinders saw, tape, drill, smooth the piece and create the decorations and facets allied with brightness and ductility.

De la poussière au cristal

Un mélange de grains fond à 1400°, repose jusqu'à ce que les maîtres verriers qui extraient le mélange le soufflent jusqu'aux parois du moule.

La forme est née et elle rendra chaque objet similaire, mais pas identique.

Le cristal est d'abord trempé pour la première sélection de qualité stricte, puis soumis à un travail à froid.

Dans le cristal, par rapport au verre, il y a de l'oxyde de plomb qui donne une réfraction de la lumière proche des propriétés optiques du diamant et une malléabilité qui permet de le graver.

Les maîtres meuleurs scient, scotchent, forent, lissent la pièce et créent les décors et facettes alliés à la brillance et à la ductilité.

Von Staub zu Kristall

Ein Mix aus Mineralien wird bei 1400 Grad geschmolzen, nach einer kurzen Ruhephase wird es von den Glasmeistern in die gewünschte Form geblasen.

Durch das verwenden der Formen sind zwar alle Produkte in Form und Größe gleich – jedoch besitzt jedes Stück durch die Handarbeit seine eigene Persönlichkeit und kann sich im Detail leicht unterscheiden.

Das Kristall wird zunächst gehärtet um die erste Qualitätskontrolle zu vollziehen. Im Nachgang wird es kalt weiterbearbeitet.

Im Kristall wird im Gegensatz zu Glas mit Bleioxiden gearbeitet – dies bewirkt eine Lichtbrechung die der eines echten Diamanten nahe kommt und ermöglicht die Nachbearbeitung der Stücke.

Die Meisterschleifer finalisieren den Prozess und sägen, kleben, bohren und glätten das Stück und geben ihm somit einzigartige Facetten kombiniert mit Glanz und Geschmeidigkeit.

От пыли к кристаллу

Смесь зерен плавится при 1400°, отдыхает до тех пор, пока мастера-стеклольщики, извлекающие смесь, не раздувают ее до стенок формы.

Рождается форма, и она сделает каждый предмет похожим, но не одинаковым.

Кристалл сначала закаляется для первого строгого отбора по качеству, затем подвергается холодной обработке.

В хрустале, по сравнению со стеклом, присутствует оксид свинца, который дает преломление света, близкое к оптическим свойствам алмаза, и ковкость, позволяющую гравировать его.

Мастера-шлифовщики пилят, наклеивают ленту, сверлят, сглаживают деталь и создают украшения и грани, сочетающиеся с яркостью и пластичностью.



1273

Lavabo in cristallo inciso a mano

Shaped crystal wash basin

Lavabo en cristal

Waschbecken aus reinem Kristallglas

Раковина фигурная прозрачная

cm Ø 41 x 14 H

• TR

• AB

1261

Specchio sagomato con LED perimetrale
Contoured mirror with perimeter LED
Miroir profilé avec LED périphérique
Konturierter Spiegel mit umlaufender LED
Контурное зеркало со светодиодом по периметру
cm 100 x 50 • Reversibile
CE: LED - 13 W - V220 - IP21

-
- LED

1051

Struttura porta lavabo in ottone con mensola in vetro e piano in marmo
Brass support with glass shelf and marble top
Support avec glass étagère avec desseu de marble
Waschtischkonsole aus Messing mit Glasablage und Marmorplatte
Консоль: керамическая раковина, стеклянная полка и мраморная столешница
cm 60 L x 47 P x 70 H

- 08
- 16 - 18 - 25 - 26

1273

Lavabo in cristallo inciso a mano
Shaped crystal wash basin
Lavabo en cristal
Waschbecken aus reinem Kristallglas
Раковина фигурная прозрачная
cm Ø 41 x 14 H

- TR
- AB

RAC 393

Sifone tornito in ottone cromato 1" ¼
Chromed brass si phon 1" ¼
Siphon en laiton chromé 1" ¼
Siphon aus verchromtem Messing 1" ¼
Хромированный сифон 1" ¼

- 08
- 16 - 25 - 26



1132

Specchio con molatura e luci spot LED
Cut mirror with grind
Miroir avec meulage
Spiegel mit Rundschliff
зеркало со шлифовкой и LED подсветкой
cm 70 x 90
CE: V220 IP21 LED 6.5W/12V 4000K

- 08

1042

Struttura porta lavabo in inox 304 lucido e cristallo laccato nero
Inox 304 support with black cristal
Suport en Inox 304 avec verre étagère noir
Untergerstell aus Edelstahl (Inox 304) mit schwarzer Glasablage
консоль из полированной нержавеющей стали 304 и черными кристаллами
cm 80 L x 50 P x 82 H

- 08

903

Specchio ingranditore bifacciale 3x a parete
Wall mounted double face enlarging mirror 3x
Miroir agrandisseur double visage à mur 3x
Wandspiegel Vergrößerung 3x doppelseitig
Настенное косметическое зеркало с 3-х кратным увеличением и реверсным механизмом
cm Ø 18 x 60 P max x 40 H • INT 130

- 08

1157

Lavabo sottopiano in ceramica
Utop washbasin
Lavabo en céramique
Keramik Aufsatzwaschbecken
раковина керамическая под столешницу
cm 62 L x 37 P x 20 H

- 08

RAC 393

Sifone tornito in ottone cromato 1" ¼
Chromed brass si phon 1" ¼
Siphon en laiton chromé 1" ¼
Siphon aus verchromtem Messing 1" ¼
Хромированный сифон 1" ¼

- 08



ELITE

001

Specchio ovale molato
Cut ovale mirror with grind
Miroir ovale coupé avec meulage
Ovaler Spiegel mit Facettenschliff
Овальное зеркало
cm 65 x 90

EL 03.2 ELITE

Appliche doppia, paralume P
Applique with 2 lamps, lampshade P
Applique avec 2 lampe, abat-jour P
Wandleuchte doppelt, Lampenglass P
Настенные 2 лампы с абажуром
cm 36 L x 15 P x 16 H
CE : V 220 IP 20 40 Wx2

- 08
- 02
- 16 - 25 - 26

1047

Struttura porta lavabo in ottone con mensola
in vetro
Brass support with glass shelf
Support avec glass étagère
Waschtischkonsole aus Messing mit Glasablage
Каркас из хромированной латуни со
стеклянной полкой
cm 100 L x 46 P x 82 H
• 08

1048

Lavabo in ceramica in stile
Ceramic washbasin
Lavabo en céramique
Waschtisch aus Keramik im klassischen Stil
Керамическая раковина
cm 102 L x 62 P x 17 H
• 01

RAC 393

Sifone tornito in ottone cromato 1" ¼
Chromed brass si phon 1" ¼
Siphon en laiton chromé 1" ¼
Siphon aus verchromtem Messing 1" ¼
Хромированный сифон 1" ¼
• 08
• 16 - 25 - 26



SMART

563

Specchio sagomato con molatura a bastone
Cut mirror with grinding
Miroir coupé avec meulage
Geformter Spiegel mit Rundschliff
Овальное зеркало
cm 70 L x 90 H

1062 LED

Appliche
Wall mounted applique
Applique à mur
Wandleuchte
Настенные светильники
cm ø 10 x 19 P x 20 H
CE : V 220 IP44 3W 3000K

- 08
- 16 - 25

1049

Struttura porta lavabo in ottone con mensola
in vetro
Brass support with glass shelf
Support avec glass étagère
Waschtischkonsole aus Messing mit Glasablage
Каркас из хромированной латуни
со стеклянной полкой
cm 70 L x 51 P x 80 H
• 08
• 16 - 25

1050

Lavabo in ceramica in stile
Ceramic washbasin
Lavabo en céramique
Waschtisch aus Keramik im klassischen Stil
Керамическая раковина
cm 70 L x 58 P x 26 H
• 01

RAC 393

Sifone tornito in ottone cromato 1" ¼
Chromed brass si phon 1" ¼
Siphon en laiton chromé 1" ¼
Siphon aus verchromtem Messing 1" ¼
Хромированный сифон 1" ¼
• 08
• 16 - 25 - 26



SPECCHI

_RIFLESSI INVOLONTARI

Designer: Stilhaus, Settimelli, Paludi, Talocci, Pallocca
Materiale: specchio 5 mm
Fuori misura: Sì

Designer: Stilhaus, Settimelli, Paludi, Talocci, Pallocca
Material: Mirror 5 mm
Customized: Yes

Designer: Stilhaus, Settimelli, Paludi, Talocci, Pallocca
Matière: Miroir 5 mm
Personnalisé: Oui

Designer: Stilhaus, Settimelli, Paludi, Talocci, Pallocca
Material: Spiegel 5 mm
Kundenwunsch: Ja

Разработка дизайна: Stilhaus, Settimelli, Paludi, Talocci, Pallocca
Используемый материал: зеркало 5 мм
Негабаритный: да





61 M14 RAME OPACO Copper matt Cuivre mat Kupfer matt Медь матовая	61 M15 ORO CHIARO OPACO Matt light gold Or clair mat Mattes Hellgold Матовое светлое золото	61 M13 ORO OPACO Matt gold Or mat Mattes Gold Матовое золото	61 M11 ALLUMINIO OPACO matt aluminium aluminium mate mattes Aluminium матовый алюминий	61 M12 PIOMBO OPACO Matt lead Plomb mat Mattes Blei матовый свинец	61 M16 BRONZO OPACO Matt bronze Bronze mat Matte Bronze Матовая бронза
---	--	--	---	--	--

specchio con cornice cm 4,5 (P), prezzo al cm:
mirror with frame cm 4,5 thick (P), price per 1cm:
miroir avec cadre cm 4,5 (P), prix par cm: €1,20
Spiegel mit Rahmen cm 4,5 (P), Preis pro lfd cm:
Багетное зеркало cm 4,5 (P) Цена за сантиметр:



ESEMPIO
EXAMPLE / EXEMPLE / BEISPIEL / Пример
RIF 61 m11 cm 70 L - 90 H = cm 320



68 M14 RAME OPACO Copper matt Cuivre mat Kupfer matt Медь матовая	68 M12 PIOMBO OPACO Matt lead Plomb mat Mattes Blei матовый свинец	68 M16 BRONZO OPACO Matt bronze Bronze mat Matte Bronze Матовая бронза	68 M13 ORO OPACO Matt gold Or mat Mattes Gold Матовое золото	68 M15 ORO CHIARO OPACO Matt light gold Or clair mat Mattes Hellgold Матовое светлое золото	68 M11 ALLUMINIO OPACO matt aluminium aluminium mate mattes Aluminium матовый алюминий
---	--	--	--	--	---

specchio con cornice cm 5,0 (P), prezzo al cm:
mirror with frame cm 5,0 thick (P), price per 1cm:
miroir avec cadre cm 5,0 (P), prix par cm:
Spiegel mit Rahmen cm 5,0 (P), Preis pro lfd cm:
Багетное зеркало cm 5,0 (P) Цена за сантиметр:



ESEMPIO
EXAMPLE / EXEMPLE / BEISPIEL / Пример
RIF P 68 M11 cm 70 L - 90 H = cm 320





WN
 Ecopelle nera con CRYSTALLIZED
 Black eco-leather with CRYSTALLIZED
 Eco-cuir noir avec CRYSTALLIZED
 Eco-Leder schwarz mit CRYSTALLIZED
 Черный кожи Фаух с CRYSTALLIZED

WB
 Ecopelle bianca con CRYSTALLIZED
 White eco-leather with CRYSTALLIZED
 Eco-cuir blanc avec CRYSTALLIZED
 Eco-Leder weiß mit CRYSTALLIZED
 Белый кожи Фаух с CRYSTALLIZED



specchio con cornice cm 5,0 (P), prezzo al cm:
 mirror with frame cm 5,0 thick (P), price per lcm:
 miroir avec cadre cm 5,0 (P), prix par cm:
 Spiegel mit Rahmen cm 5,0 (P), Preis pro lfd cm:
 Багетное зеркало см 5,0 (P) Цена за сантиметр:

specchio con cornice cm 8,5 (G), prezzo al cm:
 mirror with frame cm 8,5 thick (G), price per lcm: €2,70
 miroir avec cadre cm 8,5 (G), prix par cm:
 Spiegel mit Rahmen cm 8,5 (G), Preis pro lfd cm:
 Багетное зеркало см 8,5 (G) Цена за сантиметр:



ESEMPIO
 EXAMPLE / EXEMPLE / BEISPIEL / Пример
 RIF P WN cm 70 L - 90 H = cm 320
 RIF G WN cm 70 L - 90 H = cm 320



25
 ARGENTO LAMÉ
 Silver lamé
 Lamé argent
 Silber Lamé
 серебро

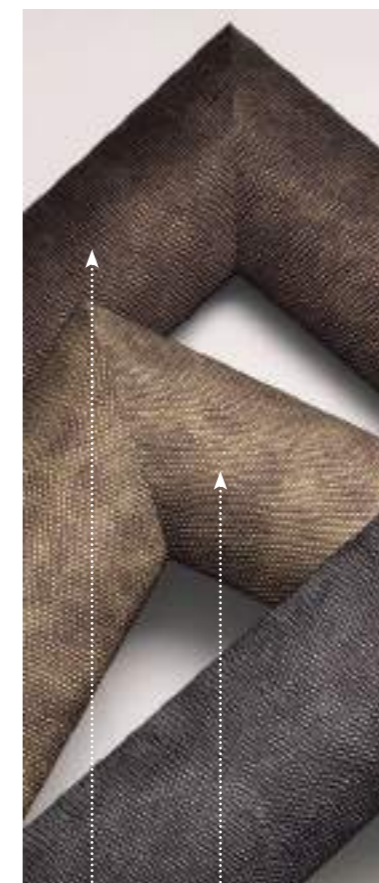

28
 BRONZO
 Bronze
 Bronze
 Bronze
 бронза



24
 ORO LAMÉ
 Gold lamé
 Lamé or
 Gold Lamé
 золото



27
 ORO
 Gold
 Or
 Gold
 золото

specchio con cornice cm 5,0 (P), prezzo al cm:
 mirror with frame cm 5,0 thick (P), price per lcm:
 miroir avec cadre cm 5,0 (P), prix par cm:
 Spiegel mit Rahmen cm 5,0 (P), Preis pro lfd cm:
 Багетное зеркало см 5,0 (P) Цена за сантиметр:

specchio con cornice cm 8,0 (G), prezzo al cm: € 1,55
 mirror with frame cm 8,0 thick (G), price per lcm: €1,55
 miroir avec cadre cm 8,0 (G), prix par cm: €1,55
 Spiegel mit Rahmen cm 8,0 (G), Preis pro lfd cm: €1,55
 Багетное зеркало см 8,0 (G) Цена за сантиметр: € 1,55



ESEMPIO
 EXAMPLE / EXEMPLE / BEISPIEL / Пример
 RIF P 25 cm 70 L - 90 H = cm 320
 RIF G 25 cm 70 L - 90 H = cm 320





83
LAVANDA
Lavender
Lavande
Lavendel
лаванда

84
VERDE GIADA
Jade Green
Vert jade
Jade grün
нефрита

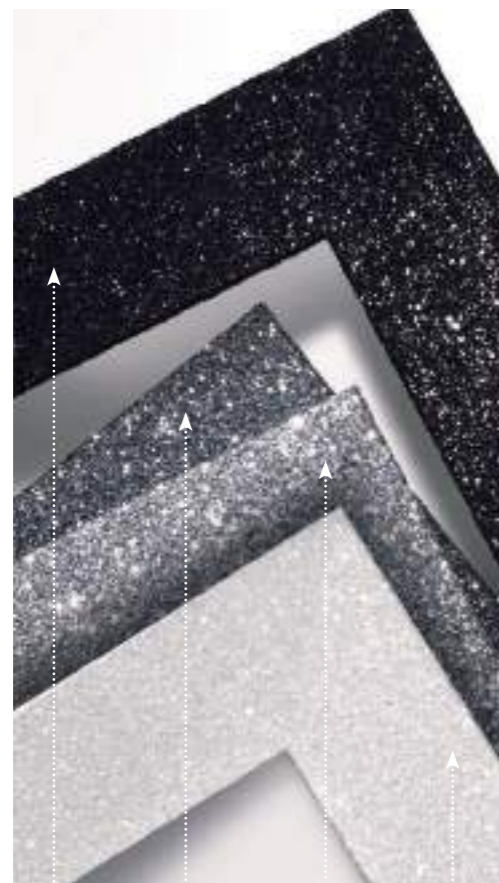

65
NERO
Black
Noir
Schwarz
черный

51
BRUNITO
Pewter
Bruni
Bruniert
полированный

50
ARGENTO
Pewter
Bruni
Bruniert
серебро

66
BIANCO
White
Blanc
Weiß
лаванда



55
ORO FORTE
Gold
Or
Gold
сильный
золото



68
ROSSO
RUBINO
Ruby red
Rouge rubis
Rubin rot
рубиново-
красный

69
BLU
ZAFFIRO
Sapphire blue
Bleu saphir
Saphir blau
синий
сапфир

80
TURCHESE
Turquoise
Turquoise
Türkis
бирюзовый

81
ROSA
AMETISTA
Pink amethyst
Rose améthyste
Amethyst rose
розовый
аметист

specchio con cornice cm 4,5 (P), prezzo al cm:
mirror with frame cm 4,5 thick (P), price per lcm:
miroir avec cadre cm 4,5 (P), prix par cm:
Spiegel mit Rahmen cm 4,5 (P), Preis pro lfd cm:
Багетное зеркало см 4,5 (P) Цена за сантиметр:

specchio con cornice cm 8,0 (G), prezzo al cm:
mirror with frame cm 8,0 thick (G), price per lcm:
miroir avec cadre cm 8,0 (G), prix par cm:
Spiegel mit Rahmen cm 8,0 (G), Preis pro lfd cm:
Багетное зеркало см 8,0 (G) Цена за сантиметр:



ESEMPIO
EXAMPLE / EXEMPLE / BEISPIEL / Пример
RIF P 83 cm 70 L - 90 H = cm 320
RIF G 83 cm 70 L - 90 H = cm 320

1217

Cavalletto per specchio
Mirror easel
Chevalet à miroir
Spiegelstaffelei
Зеркальный мольберт

• 08





005	06
ORO	ARGENTO
Gold	Silver
Or	Argent
Gold	Silber
золото	серебро

specchio con cornice foglia argento cm 10 - oro, prezzo al cml:
 mirror with frame silver - gold leaf, price per lcm:
 miroir avec cadre feuille d'argent - d'or, prix par cml:
 Spiegel mit Rahmen Silber - Gold Blatt, Preis pro lfd cm:
 Багетное зеркало лист серебро - золото, Цена за сантиметр:



ESEMPIO
 EXAMPLE / EXEMPLE / BEISPIEL / Пример
 RIF AR cm 70 L - 90 H = cm 320



OR	AR	08	33
ORO	ARGENTO	NERO	BIANCO
Gold	Silver	Black	White
Or	Argent	Noir	Blanc
Gold	Silber	Schwarz	Weiß
золото	серебро	черный	белый

specchio con cornice laccato bianco cm 9 - nero, prezzo al cml:
 mirror with frame white - black lacquered, price per lcm:
 miroir avec cadre laqué blanc - noir, prix par cml:
 Spiegel mit Rahmen Weiß - Schwarz lackiert, Preis pro lfd cm:
 Багетное зеркало лаковый белый - черный, Цена за сантиметр:

specchio con cornice foglia argento cm 9 - oro, prezzo al cml:
 mirror with frame silver - gold leaf, price per lcm:
 miroir avec cadre feuille d'argent - d'or, prix par cml:
 Spiegel mit Rahmen Silber - Gold Blatt, Preis pro lfd cm:
 Багетное зеркало лист серебро - золото, Цена за сантиметр:



ESEMPIO
 EXAMPLE / EXEMPLE / BEISPIEL / Пример
 RIF P 33 cm 70 L - 90 H = cm 320
 RIF G AR cm 70 L - 90 H = cm 320





488

Specchio ingranditore 3x a parete con supporto flessibile
 Wall mounted enlarging mirror 3x with flexible support
 Miroir agrandisseur à mur 3x avec je supporte flexible
 Wandspiegel Vergrößerung 3x mit flexibler Wandhalterung
 Настенное косметическое зеркало с 3-х кратным увеличением на гибком держателе
 cm Ø 14 x 14 P • Base Ø 7,5

• 08



751

Specchio ingranditore 3x rettangolare a parete
 Wall mounted rectangular enlarging mirror 3x
 Miroir agrandisseur 3x rectangulaire à mur
 Rechteckiger Wandspiegel mit Vergrößerung 3x
 Настенное косметическое зеркало с 3-х кратным увеличением
 cm 14 L x 27 P x 20 H • Base 4 L x 2 P x 9 H

• 08



16

23

25

17

36



1035

Specchio ingranditore 3x a parete con supporto snodato singolo
 Wall mounted enlarging mirror 3x with single adjustable support
 Miroir agrandisseur à mur 3x avec je supporte flexible
 Wand-Vergrößerungsspiegel 3x mit LED-Beleuchtung
 Настенное косметическое зеркало с 3-х кратным увеличением на гибком держателе
 Cm Ø 14 x 20 P Max x H14 • Base Ø 5

• 08

• 23

• 16 - 25 - 36

• 17



1093

Specchio ingranditore 3x a parete con supporto snodato singolo
 Wall mounted enlarging mirror 3x with single adjustable support
 Miroir agrandisseur à mur 3x avec je supporte flexible
 Wand-Vergrößerungsspiegel 3x mit LED-Beleuchtung
 Настенное косметическое зеркало с 3-х кратным увеличением на гибком держателе
 cm 15 L x 6/18 P x 15 H • Base 5 L x 5 H x 1 P

• 08



1092

Specchio ingranditore 3x tondo a parete
 Wall mounted round enlarging mirror 3x
 Miroir agrandisseur 3x round à mur
 Runde Wandspiegel mit Vergrößerung 3x
 Настенное косметическое зеркало с 3-х кратным увеличением
 Cm Ø 20 x 8/18 P • Base Ø 5 x 1 H

• 08 - 23



1091

Specchio ingranditore 3x quadrato a parete
 Wall mounted square enlarging mirror 3x
 Miroir agrandisseur 3x carré à mur
 Quadratisch Wandspiegel mit Vergrößerung 3x
 Настенное косметическое зеркало с 3-х кратным увеличением
 Cm 20 L x 8 P x 20 H • Base 5 L x 1 P x 5 H

• 08 - 23



23



23

POTENZA DI INGRANDIMENTO

MAGNIFICATION POWER / POUVOIR DE GROSSISSEMENT /
 MACHT DER VERGRÖSSERUNG / Увеличение мощности

La calotta concava avvicina l'immagine a una distanza che varia dai 30 cm ai 10 cm, a seconda della potenza di ingrandimento dello specchio.

The concave shell approaches the image at a distance ranging from 30 cm to 10 cm, depending on the magnification power of the mirror.

La coque concave s'approche de l'image à une distance allant de 30 cm à 10 cm, en fonction de la puissance d'agrandissement du miroir.

Die konkave Schale nähert sich dem Bild in einem Abstand von 30 cm bis 10 cm, abhängig von der Vergrößerungsstärke des Spiegels.

Вогнутый колпачок приближает изображение на дистанцию от 30 до 10 см, в зависимости от увеличения мощности зеркала.



2X

ingrandisce circa 2 volte a 30 cm di distanza
 enlarges about 2 times to 30 cm away
 agrandit environ 2 fois à 30 cm
 vergrößert sich ca. 2 mal auf 30 cm
 увеличение примерно в 2 раза на расстоянии 30 см



3X

ingrandisce circa 3 volte a 25 cm di distanza
 enlarges about 3 times to 25 cm away
 agrandit environ 3 fois à 25 cm
 vergrößert sich ca. 3 mal auf 25 cm
 увеличение примерно в 3 раза на расстоянии 25 см



4X

ingrandisce circa 4 volte a 20 cm di distanza
 enlarges about 4 times to 20 cm away
 agrandit environ 4 fois à 20 cm
 vergrößert sich ca. 4 mal auf 20 cm
 увеличение примерно в 4 раза на расстоянии 20 см



6X

ingrandisce circa 6 volte a 10 cm di distanza
 enlarges about 6 times to 10 cm away
 agrandit environ 6 fois à 10 cm
 vergrößert sich ca. 6 mal auf 10 cm
 увеличение примерно в 6 раз на расстоянии 10 см

Solo su articoli 783 e 1036
 only articles 783 and 1036
 seulement article 783 et 1036
 nur artikel 783 mit 1036
 Только арт. 783 и 1036

Solo su articoli 1036 senza illuminazione, stesso prezzo
 only articles 1036 without illumination, same price
 seulement article 1036 sans éclairage, même prix
 nur artikel 1036 ohne Beleuchtung, gleicher Preis
 Только арт. 1036 без освещения, одинаковая цена

INGRANDITORI



1037

Specchio ingranditore 3x a parete con supporto snodato singolo
Wall mounted enlarging mirror 3x with single adjustable support
Miroir agrandisseur double visage à mur 3x avec je supporte single
Wand-Vergrößerungsspiegel 3x mit LED-Beleuchtung
Настенное косметическое зеркало с 3-х кратным увеличением на гибком держателе
cm Ø 18 x 24 P • Base Ø 10

• 08

• 16 - 25 - 36



1209 DORIAN [DESIGN GIANLUCA PALUDI]

Specchio ingranditore 3x con calamita
3x enlarging mirror with magnet
Miroir agrandisseur 3x avec aimant
Wandspiegel Vergrößerung 3x mit Magnet
3-кратное увеличительное зеркало с магнитом
cm 14 L x 10 P



• 08

• Piastrespecchio/Mirrorplate/Plaquedemiroir/Spiegelplatte/Зеркальнаяпластина

256_SPECCHI



489

Specchio ingranditore bifacciale 3x con supporto snodato
Wall mounted double face enlarging mirror 3x with adjustable support
Miroir agrandisseur double visage à mur 3x avec je supporte réglable
Wandspiegel mit Vergrößerung 3x, doppelseitig und klappbar
Настенное косметическое зеркало с 3-х кратным увеличением и поворотным механизмом
cm Ø 18 x 26 L x 40 P max • Base Ø 10

• 08

• 16 - 25 - 36



1075

Specchio ingranditore 3x per specchio da incollo
Glue fixing enlarging mirror 3x for mirror
Miroir agrandisseur 3x par collie pour miroir
Wandspiegel Vergrößerung 3x mit Klebstoff
Увеличительное зеркало 3x с установкой на зеркало
cm Ø 18



• 08



903

Specchio ingranditore bifacciale 3x a parete
Wall mounted double face enlarging mirror 3x
Miroir agrandisseur double visage à mur 3x
Wandspiegel Vergrößerung 3x doppelseitig
Настенное косметическое зеркало с 3-х кратным увеличением и реверсным механизмом
cm Ø 18 x 60 P max x 40 H • INT 18

• 08

• 16 - 25 - 36



1096

Specchio ingranditore 3x a parete
Wall-mounted 3x magnifying mirror
Miroir mural grossissant 3x
Wandmontierter 3x Vergrößerungsspiegel
Настенное 3-кратное увеличительное зеркало
cm Ø 20 x 3/22 P max • Base 5 L x 1 P x 13 H

HQC

• 08

INGRANDITORI





23



561

Specchio ingranditore 3x quadrato con base
 Square enlarging mirror 3x with base
 Miroir agrandisseur 3x cadré d'appui
 Quadratischer Standspiegel mit Vergrößerung 3x
 Настольное косметическое зеркало с 3-х кратным увеличением
 cm 16 L x 19 P x 30 H - base 10 x 10

• 08

• 23



23



562

Specchio ingranditore 3x rettangolare con base
 Rectangular enlarging mirror 3x with base
 Miroir agrandisseur 3x rectangulaire d'appui
 Rechteckiger Standspiegel mit Vergrößerung 3x
 Настольное косметическое зеркало с 3-х кратным увеличением
 cm 13 L x 9 P x 34 H - base 10 x 10

• 08

• 23



23



1092 AP

Specchio ingranditore 3x tondo con base
 Round enlarging mirror 3x with base
 Miroir agrandisseur 3x rond d'appui
 Runder Standspiegel mit Vergrößerung 3x
 3-х круглое увеличительное зеркало с основанием
 cm 13 L x 9 P x 34 H - base 10 x 10

• 08

• 23



16



1287

Specchio ingranditore 3x con batteria
 3x magnifying mirror with battery
 Miroir grossissant 3x avec pile
 3x Vergrößerungsspiegel mit Batterie
 3-кратное увеличительное зеркало с батареей
 cm Ø 18,5 x 37/50 H • Base Ø 12,5

• 08

• 16



25



16



36



752

Specchio ingranditore 3x bifacciale con base
 Double face enlarging mirror 3x with base
 Miroir agrandisseur 3x double visage d'appui
 Doppelseitiger Standspiegel mit Vergrößerung 3x
 Настольное косметическое зеркало с 3-х кратным увеличением
 cm Ø 18,5 x 40 H • Base 12,5

• 08

• 16 - 25 - 36



NT 956

Specchio ingranditore 3X bifacciale con base
 Double face enlarging mirror 3x with base
 Miroir agrandisseur 3x double visage d'appui
 Doppelseitiger Standspiegel mit Vergrößerung 3x
 Настольное косметическое зеркало с 3-х кратным увеличением
 cm Ø 18,5 x 22 L x 51 H • Base Ø 12,5

• 08





23

25

16

36



1036

Specchio ingranditore 4x da parete con illuminazione LED
Wall monde enlarging mirror 4x with LED light
Miroir agrandisseur à mur 4x avec LED
Schwenkbarer Wand-Vergrößerungsspiegel 4x
Настенное косметическое зеркало с 4-х кратным увеличением и подсветкой
Cm ø 22 x 40P Max H22 • Base Ø 12,5

CE : V 220 12V 4W

• 08

• 26 - 16 - 36 - 23



1097

Specchio ingranditore 3x da parete con illuminazione LED
Wall monde enlarging mirror 3x with LED light
Miroir agrandisseur à mur 3x avec LED
Schwenkbarer Wand-Vergrößerungsspiegel 3x
Настенное косметическое зеркало с 3-х кратным увеличением и подсветкой
Cm ø 21 x 39 P • Base Ø 12

CE : V 220 12V 4W

• 08

HQC



1252

Specchio ingranditore calamitato con illuminazione LED
Magnetised magnifying mirror with LED lighting
Miroir grossissant magnétisé avec éclairage LED
Magnetischer Vergrößerungsspiegel mit LED-Beleuchtung
Магнитичное увеличительное зеркало со светодиодной подсветкой
Cm ø 21 x 39 P • Base Ø 12

CE : V 220 12V 4W

• 08

• piastra specchio



902

Specchio ingranditore 3x con illuminazione a LED
Wall mounted enlarging mirror 3x with LED light
Miroir agrandisseur à mur 3x avec éclairage à LED
Wandspiegel Vergrößerung 3x mit LED Beleuchtung
Настенное косметическое зеркало с 3-х кратным увеличением и подсветкой
cm ø 24 x 40 P max x 24 H • Base Ø 12 x 2 H

CE : V 220 12V 4W

• 08

• 16



901

Specchio ingranditore 3x con illuminazione a LED
Wall mounted enlarging mirror 3x with LED light
Miroir agrandisseur à mur 3x avec éclairage à LED
Wandspiegel Vergrößerung 3x mit LED Beleuchtung
Настенное косметическое зеркало с 3-х кратным увеличением и подсветкой
cm 22 L x 39 P x 22 H • Base 12 L x 12 P x 2,5 H

CE : V 220 12V 4W

• 08



1282

Specchio ingranditore a soffietto con batteria
Ceiling-mounted magnifying mirror with battery
Miroir grossissant au plafond avec batterie
Deckenvergrößerungsspiegel mit Batterie
Складное увеличительное зеркало с аккумулятором
cm 22 L x 39 P x 22 H • Base 12 L x 12 P x 2,5 H

CE : V 220 12V 4W

• 08

• 16 - 25 - 36





1065

20 GG

Specchio filo lucido con ingranditore 3x
 Rectangular mirror with enlarging mirror 3x
 Miroir rectangulaire avec miroir agrandisseur 3x
 Rechteckiger Wandspiegel mit Vergrößerung 3x
 зеркало с LED подсветкой и 3-х кратным увеличением
 cm 112 L x 64 H - ING. Ø 21

D T 3

1289

20 GG

Specchio filo lucido con ingranditore 3x
 Rectangular mirror with enlarging mirror 3x
 Miroir rectangulaire avec miroir agrandisseur 3x
 Rechteckiger Wandspiegel mit Vergrößerung 3x
 зеркало с LED подсветкой и 3-х кратным увеличением
 cm Ø 80 - ING. Ø 21

D T 3

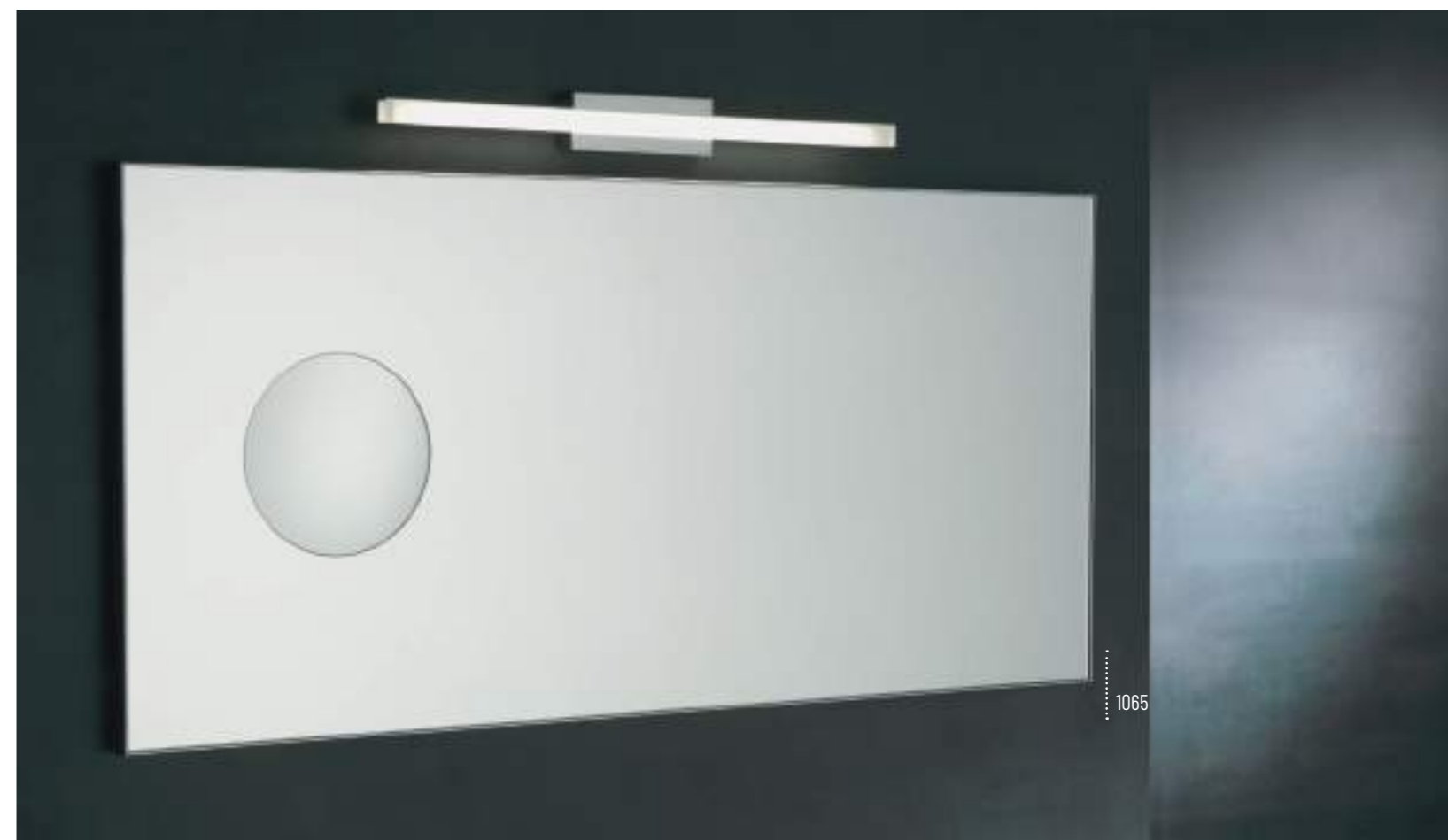

1065



1140

20 GG

Specchio filo lucido con ingranditore 3x illuminazione LED
 Rectangular mirror with enlarging mirror 3x LED
 Miroir rectangulaire avec miroir agrandisseur 3x LED
 Rechteckiger Wandspiegel mit Vergrößerung 3x LED
 зеркало с LED подсветкой и 3-х кратным увеличением
 cm 112 L x 64 H - ING. Ø 21
 CE : V 220 12V 4W

A D T 3

1290

20 GG

Specchio filo lucido con ingranditore 3x illuminazione LED
 Rectangular mirror with enlarging mirror 3x LED
 Miroir rectangulaire avec miroir agrandisseur 3x LED
 Rechteckiger Wandspiegel mit Vergrößerung 3x LED
 зеркало с LED подсветкой и 3-х кратным увеличением
 cm Ø 80 - ING. Ø 21
 CE : V 220 12V 4W

A D T 3



1140

CONTENITORI



1291

Specchio con contenitore in acciaio inox
 Mirror with container in stainless steel
 Miroir avec conteneur en acier inox
 Spiegelschrank Edelstahl
 Зеркальный шкаф из нержавеющей стали
 cm 50 L x 14 P x 90 H

• filo lucido/shine edge/bord brillant/glänzender Rand / провод полированный



599

Specchio ad angolo con contenitore in acciaio inox
 Corner mirror with container in stainless steel
 Miroir à angle avec conteneur en acier inox
 Eck Spiegelschrank Edelstahl
 Зеркальный шкаф угловой из нержавеющей стали
 cm 41 L x 30 P x 80 H

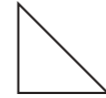

• filo lucido/shine edge/bord brillant/glänzender Rand / провод полированный



550

Specchio con contenitore in acciaio inox
 Mirror with container in stainless steel
 Miroir avec conteneur en acier inox
 Spiegelschrank Edelstahl
 Зеркальный шкаф из нержавеющей стали
 cm Ø 60 x 14 P



• filo lucido/shine edge/bord brillant/glänzender Rand / провод полированный



606

Specchio con contenitore in acciaio inox
 Mirror with container in stainless steel
 Miroir avec conteneur en acier inox
 Spiegelschrank Edelstahl
 Зеркальный шкаф из нержавеющей стали
 cm 45 L x 14 P x 62 H



• filo lucido/shine edge/bord brillant/glänzender Rand / провод полированный



SPECCHI



1073

Specchio con mensola
Cut mirror with shelf
Miroir coupé avec étagère
Geformter Spiegel
Декоративное зеркало
cm 50 L x 12 P x 70 H



• filo lucido/shine edge/bord brillant/glänzender Rand / провод полированный



1212

Specchio con cintura in cuoio
Mirror with leather belt
Miroir avec ceinture en cuir
Spiegel mit Ledergürtel
Зеркало с кожаным ремнем
cm Ø 80 x P3,5 x H105/110



1227

Specchio tondo con metallo e retroilluminazione
Round mirror with metal and backlighting
Miroir rond avec métal et rétro-éclairage
Runder Spiegel mit Metall und Hintergrundbeleuchtung
Круглое зеркало с металлической и подсветкой
cm Ø 60

CE: LED - 13 W - V220 - IP21

• 23



1285

Specchio retroilluminato con punti led
Backlit mirror with LED dots
Miroir rétro-éclairé avec points LED
Hintergrundbeleuchteter Spiegel mit LED-Punkten
Зеркало с подсветкой и светодиодными точками
cm Ø 80

CE: LED - 15 W - V220 - IP21



RETTANGOLARI

OPZIONI / Options / Options / Optionen / Опции **P V Q R S U** pag.292



499

Specchio rettangolare filo lucido reversibile
 Reversible rectangular mirror with shine edge
 Miroir rectangulaire avec bord brillant réversible
 Rechteckiger Spiegel mit glänzendem Rand
 Прямоугольное зеркало
 cm 70 x 90 • Reversibile

• 583 reversibile



583

Specchio rettangolare filo lucido reversibile
 Reversible rectangular mirror with shine edge
 Miroir rectangulaire avec bord brillant réversible
 Rechteckiger Spiegel mit glänzendem Rand
 Прямоугольное зеркало
 cm 50 x 105 • Reversibile

• 583 reversibile



08



23

678 - 679

Specchio con cornice cromata reversibile
 Reversible mirror with chromed frame
 Miroir avec cadre chrome réversible
 Spiegel mit verchromtem Rand
 Прямоугольное зеркало



678 cm 50 x 70 • 08 - 23

679 cm 50 x 90 • 08 - 23

268_SPECCHI



Su richiesta si realizzano personalizzazioni P.290 / Customisation on request P.290 / Personnalisation sur demande P.290 / Personalisierung auf Anfrage P.290 / Персонализация по запросу P.290



498

Specchio quadrato
 Square mirror
 Miroir carré
 Quadratischer Spiegel
 квадратное зеркало
 cm 45 x 45

• filo lucido/shine edge/bord brillant/glänzender Rand / провод полированный

• molato(photo)/withgrind(photo)/avecmeulage(photo)/mitSchiff(Bild)/скошенные





0 01

Specchio ovale molato
Cut ovale mirror with grind
Miroir ovale coupé avec meulage
Ovaler Spiegel mit Facettenschliff
Овальное зеркало
cm 65 x 90 • Reversibile



1238

Specchio ovale filo lucido
Oval mirror with polished edges
Miroir ovale avec bords polis
Ovaler Spiegel mit polierten Kanten
Овальное зеркало с полированными краями
cm 40 L x 70 H

• reversibile

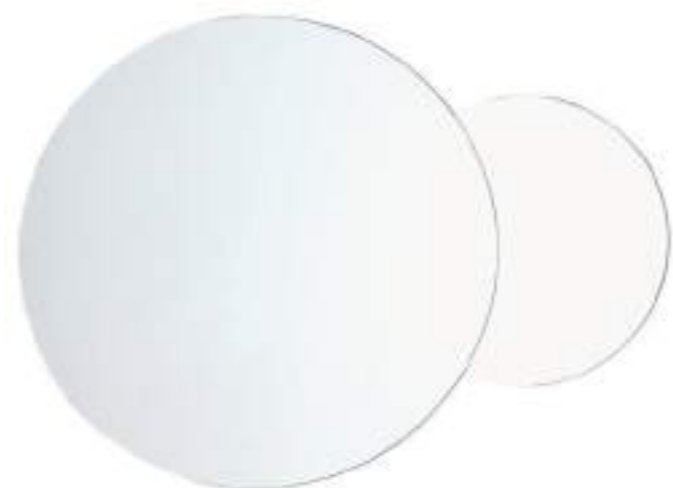

1178 BI-BUBLE

Specchi tondi sovrapposti con LED perimetrale
Round mirrors superimposed with perimeter LED
Round mirrors superimposed with perimeter LED
Runde Spiegel, die mit einer LED überlagert sind
Складные круглые зеркала со светодиодами по периметру
cm 115 L x 80 H

CE: Led 16 W - V 220 - IP44



• filo lucido/shine edge/bord brillant/glänzender Rand / провод полированный

• con led perimetrale /with diffused led light / avec led lumiere diffused /

mit led Hinterleuchtung / LED периметру с



10 GG

Specchio rotondo
Round mirror
Miroir rond
Runder Spiegel
Круглое зеркало

• 497 Ø 50

• 1113 Ø 60

• 1114 Ø 70

• 1170 Ø 80

• 1190 Ø 90



SAGOMATI



1001 PEONIA [DESIGN MASSIMILIANO SETTIMELLI] mod. dep. 402016000082680

Specchio sagomato filo lucido
Cut mirror with shine edge
Miroir coupé avec bord brillant
Geformter Spiegel umkehrbar mit Rand
Овальное зеркало
cm 80 x 86



1040 OMNIA

Specchio con molatura a bastone
Cut mirror with grind
Miroir avec meulage
Spiegel mit Rundschliff
Овальное зеркало
cm 105 x 80 • Reversibile



895 LUI [DESIGN MASSIMILIANO SETTIMELLI] mod. dep. 402016000082680

LUI specchio sagomato filo lucido
LUI cut mirror with shine edge
LUI miroir coupé avec bord brillant
LUI geformter Spiegel mit glänzendem Rand
Мужская форма зеркала
cm 76 L x 65 H



896 LEI [DESIGN MASSIMILIANO SETTIMELLI] mod. dep. 402016000082680

LEI specchio sagomato filo lucido
LEI cut mirror with shine edge
LEI miroir coupé avec bord brillant
LEI geformter Spiegel mit glänzendem Rand
Женская форма зеркала
cm 76 L x 65 H





1041

Specchio con LED perimetrale
 Mirror with diffused led light
 Miroir avec led lumiere diffused
 Spiegel mit LED Hinterleuchtung
 Прямоугольное зеркало с внутренней подсветкой и алюминиевым обрамлением
 cm 80 x 100 • Reversibile
 CE: Led 26 W - V 220 - IP21



1066

Specchio Retroilluminato LED, con fasce satinare
 Mirror with LED light
 Miroir avec LED lumiere
 Spiegel mit LED Hinterleuchtung
 Зеркало с подсветкой
 cm 60 x 80 • Reversibile
 CE: Led 15 W - V 220 - IP21

15 GG

- 08



1192

Specchio con Led perimetrale e sabbiatura cm 4
 Mirror with perimeter LED and sandblasting 4 cm
 Miroir avec périmètre LED et sablage 4 cm
 Spiegel mit Perimeter LED und Sandstrahlen 4 cm
 Зеркало по периметру Светодиодный и пескоструйный см 4
 cm 70 x 90 • Reversibile
 CE: Led 28 W - V 220 - IP44



1193

Specchio con Led perimetrale e sabbiatura interna da 3 cm
 Mirror with perimeter Led and 3 cm internal sandblasting
 Miroir avec Led de périmètre et sablage interne de 3 cm
 Spiegel mit umlaufender Led und 3 cm internem Sandstrahlen
 Зеркало по периметру Светодиодное и 3 см внутренняя пескоструйная обработка
 cm 70 x 90 • Reversibile
 CE: Led 28 W - V 220 - IP44

20 GG





1261

Specchio sagomato con LED perimetrale
Contoured mirror with perimeter LED
Miroir profilé avec LED périphérique
Konturierter Spiegel mit umlaufender LED
Контурное зеркало со светодиодом по периметру
cm 70 L x 70 H
CE: LED - 13 W - V220 - IP21

- filo lucido/shine edge/bord brillant/glänzender Rand / провод полированный
- con led perimetrale /with diffused led light / avec led lumiere diffused / mit led Hinterleuchtung / LED периметру с



1263

Specchio sagomato con LED perimetrale
Contoured mirror with perimeter LED
Miroir profilé avec LED périphérique
Konturierter Spiegel mit umlaufender LED
Контурное зеркало со светодиодом по периметру
cm Ø 70
CE: LED - 13 W - V220 - IP21

- 08



1262

Specchio sagomato con LED perimetrale
Contoured mirror with perimeter LED
Miroir profilé avec LED périphérique
Konturierter Spiegel mit umlaufender LED
Контурное зеркало со светодиодом по периметру
cm 100 x 50 • Reversibile
CE: LED - 13 W - V220 - IP21

- filo lucido/shine edge/bord brillant/glänzender Rand / провод полированный
- con led perimetrale /with diffused led light / avec led lumiere diffused / mit led Hinterleuchtung / LED периметру с



1264

Specchio tondo con lampada
Round mirror with lamp
Miroir rond avec lampe
Runder Spiegel mit Lampe
Круглое зеркало со светильником
cm Ø 70
CE: LED - 13 W - V220 - IP21

- filo lucido/shine edge/bord brillant/glänzender Rand / провод полированный





1208 DORIAN [DESIGN GIANLUCA PALUDI]

Specchio sagomato
Cut mirror
Miroir coupé
Geformter Spiegel
Декоративное зеркало
cm 86 x 86 • Reversibile
CE: LED - 26 W - V220 - IP21

- filo lucido/shine edge/bord brillant/glänzender Rand / провод полированный
- con led perimetrale /with diffused led light / avec led lumiere diffused / mit led Hinterleuchtung / LED периметру с
- 1209 - Specchio ingranditore calamitato

15 GG

Specchio con LED perimetrale
Mirror with diffused led light
Miroir avec led lumiere diffused
Spiegel mit LED Hinterleuchtung
Прямоугольное зеркало с внутренней подсветкой и алюминиевым обрамлением
cm Ø 70
CE: Led 26 W - V 220 - IP21

- 1118 Ø 70
- 1191 Ø 80
- 1179 Ø 90



1159

Specchio con LED perimetrale
Mirror with diffused led light
Miroir avec led lumiere diffused
Spiegel mit LED Hinterleuchtung
Прямоугольное зеркало с внутренней подсветкой и алюминиевым обрамлением
cm 50 x 90 • Reversibile
CE LED 13 W - V 220 IP44

15 GG

LV 01

Specchio sagomato
Cut mirror
Miroir coupé
Geformter Spiegel
Декоративное зеркало
cm 50 L x 90 H
CE: LED - 26 W - V220 - IP21

- filo lucido/shine edge/bord brillant/glänzender Rand / провод полированный
- con led perimetrale /with diffused led light / avec led lumiere diffused / mit led Hinterleuchtung / LED периметру с





08



23

842

15 GG

Specchio Retroilluminato LED, con cornice cromata
Mirror with LED light, chrome aluminium frame
Miroir avec LED lumière, cadre en aluminium Chromé
Spiegel mit LED Hinterleuchtung und Halterung aus Chrom
Зеркало с подсветкой, с хромированной алюминиевой раме
cm 60 L x 90 H



CE: LED - 9W - V220 - IP21

- 08 - 23



08



23

843

15 GG

Specchio Retroilluminato LED, con cornice cromata
Mirror with LED light, chrome aluminium frame
Miroir avec LED lumière, cadre en aluminium chromé
Spiegel mit LED Hinterleuchtung und Halterung aus Chrom
Зеркало с подсветкой, с хромированной алюминиевой раме
cm 90 L x 70 H



CE: LED - 10,5W - V220 - IP21

- 08 - 23



08



23

949

15 GG

Specchio retroilluminato LED, cornice cromata, luce perimetrale diffusa
Mirror with diffused led light, chrome aluminium frame
Miroir avec led lumière diffuse, cadre en aluminium Chromé
Spiegel mit LED-Beleuchtung (diffus) und Halterung aus Chrom
Зеркало с подсветкой, с хромированной алюминиевой раме, рассеянный свет
cm 60 L x 90 H



CE: LED - 9+5 W - V220 - IP21

- 08 - 23



08



23

948

15 GG

Specchio retroilluminato LED, cornice cromata, luce diffusa
Mirror with diffused led light, chrome aluminium frame
Miroir avec led lumière diffuse, cadre en aluminium Chromé
Spiegel mit LED-Beleuchtung (diffus) und Halterung aus Chrom
Зеркало с подсветкой, с хромированной алюминиевой раме, рассеянный свет
cm 90 L x 70 H



CE: LED - 13+8,6 W - V220 - IP21

- 08 - 23





1115 P V Q R S U 15 GG

Specchio Retroilluminato LED, con cornice cromata
Mirror with LED light, chrome aluminium frame
Miroir avec LED lumière, cadre en aluminium chromé
Spiegel mit LED Hinterleuchtung und Halterung aus Chrom
Зеркало с подсветкой, с хромированной алюминиевой раме



CE: LED - 19,2W - V220 - IP21

• 08 - 23



1210 P V Q R S U 20 GG

Specchio retroilluminato con 8 spot led, con cornice cromata
Backlit mirror with 8 led spots, with chromed frame
Miroir rétro-éclairé avec 8 spots LED, avec cadre chromé
Von hinten beleuchteter Spiegel mit 8 LED-Spots, mit verchromtem Rahmen
Зеркало с подсветкой с 8 светодиодными точками, с хромированной рамой



CE: LED - 3x3,5W - V220 - IP21

• 08



1175/1308 P V Q R S U 15 GG

Specchio retroilluminato, luce cost to cost
Mirror with led light cost to cost
Miroir avec led lumière cost to cost
Hinterleuchteter Spiegel, Kosten für Licht
Зеркало с подсветкой, стоимость света



CE: Led 7 W - V 220 - IP21

1175 cm 30 L x 70 H • 08 - 23

1308 cm 50 L x 90 H • 08 - 23

282_SPECCHI



1139 V Q U

Specchio Retroilluminato LED, con cornice cromata
Mirror with LED light, chrome aluminium frame
Miroir avec LED lumière, cadre en aluminium Chromé
Spiegel mit LED Hinterleuchtung und Halterung aus Chrom
Зеркало с подсветкой, с хромированной алюминиевой раме



CE: Led 28 W - V 220 - IP21

• 08





1194

Specchio con luce orientabile doppia
 Mirror with double adjustable light
 Miroir avec double lumière réglable
 Spiegel mit doppelt verstellbarem Licht
 Зеркало с двойной регулируемой подсветкой
 cm 80/106 L x 70 H
 CE: LED - 19,2W - V220 - IP21



- 08



1195

Specchio con luce orientabile singola
 Mirror with adjustable light
 Miroir avec lumière réglable
 Spiegel mit verstellbarem Licht
 Зеркало с одним регулируемым освещением
 cm 70 L x 83/93 H
 CE: LED - 10W - V220 - IP21

- 08



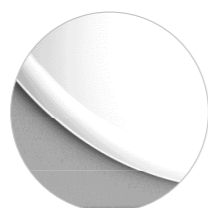

798

Specchio tondo con molatura a bastone
Cut round mirror with grind
Miroir coupé avec meulage
Runder Spiegel mit Rundschliff
Круглое зеркало
cm Ø 70



968

Specchio molato e inciso
Bavelled mirror and engraved
Miroir avec meulage et gravée
Spiegel mit geätzten Rundschliff
зеркало скошенные травленое
cm 70 L x 90 H



906

Specchio rettangolare con molatura a bastone
Cut rectangular mirror with grind
Miroir rectangulaire avec meulage
Rechteckiger Spiegel mit Rundschliff
Овальное зеркало
cm 65 L x 90 H



563

Specchio sagomato con molatura a bastone
Cut mirror with grinding
Miroir coupé avec meulage
Beformter Spiegel mit Rundschliff
Овальное зеркало
cm 70 L x 90 H



CLASSICI



EL 01 ELITE

Specchio molato orientabile
Adjustable and grind mirror
Miroir réglable avec meulage
Justierbare Spiegel mit Rundschiiff
зеркало скошенные регулируемый
cm 63 L x Ø 50 x 10 P



- 08

- 16 - 25 - 36



G 698 GIUNONE

Specchio attrezzato come foto
Equipped mirror same photo
Miroir équipé comme photo
Spiegel mit Ablage und Beleuchtung
Зеркало с латунной рамой с полкой
cm 70 L x 95 H



- 08

- 16 - 25 - 36



PR 01 PRISMA

Specchio molato orientabile
Adjustable and grind mirror
Miroir réglable avec meulage
Justierbare Spiegel mit Rundschiiff
зеркало скошенные регулируемый
cm 63 L x 70 H x 10 P



- 08

- 16 - 25 - 36

288_SPECCHI



R 01.03

Specchio sagomato molato
Cut mirror with grind
Miroir coupé avec meulage
Geformter Spiegel mit Schliff
Зеркало скошенные
cm 60 L x 80 H







SPECCHI SU MISURA









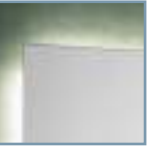

MIRROR ON MEASURE / MIROIRS SUR MEASURE / MIT GLÄNZENDEM RAND/ зеркала под заказ

- 1 VETRO a filo lucido (indicare L x H):
GLASS with shine edge (indicate L x H):
VERRE bord brillant (indiquer L x H):
GLAS mit glänzendem rand (zeigen L x H):
стекло с полированными краями (государственный ШХВ): 20 - 220 cm
- 2 VETRO molato cm 1 (indicare L x H)
GLASS Grind cm 1 (indicate L x H):
VERRE Meulage cm 1 (indiquer L x H):
GLAS Facettenschliff cm 1 (zeigen L x H):
стекло земля 1 см (Ш x В): указывающие 20 - 220 cm
- 3 VETRO tondo filo lucido
GLASS round with shine edge:
VERRE bord brillant (indiquer L x H):
GLAS mit glänzendem Rand (zeigen L x H):
стекла круглой формы 30 - 150 cm

FISSAGGI PER SPECCHI NON RETROILLUMINATI/ FIXING FOR MIRROR WITHOUT LED BACKLIGHTED/ CHÂSSIS POUR MIROIRS SANS RÉTRO-ÉCLAIRAGE/ Rahmen für Spiegel ohne LED-integrierte/ Крепеж для зеркал без светодиодной подсветки

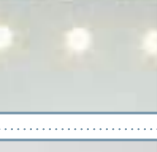

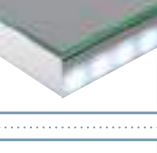

	ESEMPIO EXAMPLE / EXEMPLE BEISPIEL / Пример			
• A) Piastra per specchi, mm 6, senza illuminazione (fino cm 80 L/H) Mirror slab mm 6 (up to cm 80) Plaque mm 6 pour mirror (jusqu'à 80 cm) Platte mm 6 für Spiegel (bis zu 80cm) Пластинчатые 6 мм для зеркал	1+ A	[maggiorazione] supplement supplément Aufpreis дополнение	498	
• B) Solo telaio inox lucido, mm 26 Only frame mm 26 Seulement cadre mm 26 Rahmen Edelstahl poliert Только 26 мм полированная рама из нержавеющей стали	1+ B	[maggiorazione] supplement supplément Aufpreis дополнение	583	
• D) Cornice cromata, mm 25 Chromed frame mm 25 Cadre Chrome mm 25 Rahmen Verchromt mm 25 Хромовый остов 25 мм	1+ D	[maggiorazione] supplement supplément Aufpreis дополнение	678	
• Z) Cornice nero opaco, mm 25 Chromed frame mm 25 Cadre Chrome mm 25 Rahmen Verchromt mm 25 Хромовый остов 25 мм	1+ Z	[maggiorazione] supplement supplément Aufpreis дополнение	678	
• E) Per specchi con lato superiore cm 150 L For mirrors biggest than cm 150 L Pour miroir avec une longueur supérieure à cm 150 Spiegel ab 150 cm Länge для зеркала свыше 150 L доплата	1+ B + E	[maggiorazione] supplement supplément Aufpreis дополнение	← cm 150 →	

RETROILLUMINATI LED 4000K / LED BACKLIGHTED 4000K / RÉTRO-ÉCLAIRAGE LED 4000K / LED-integrierte 4000K/ со светодиодной подсветкой 4000K

	ESEMPIO EXAMPLE / EXEMPLE BEISPIEL / Пример			
• O) Impianto o cornice cromo o nero, per specchi con luce LED - OBLIGATORIO Plant and frame for mirrors with only perimeter light - OBLIGATORY Plante et cadre de miroirs avec seulement la lumière de périmètre - OBLIGATOIRE Halterung und Rahmen für Spiegel mit Umrandungsbeleuchtung - OBLIGATOIRISCH Машины и рама зеркала с только легкой периметру	1+ O +	[maggiorazione] supplement supplément Aufpreis дополнение	842/1159	
• F) Retroilluminati sabbatura cm 50 max, led 10 W Backlit mirrors, frame, frosted glass cm 50 max, led 10 W Miroirs avec la lumierer, cadre, en verre dépoli cm 50 max, led 10 W Spiegel mit integrierter LED-Leuchte, Rahmen verchromt Milchglas cm 50 max, led 10 W Подсветка Chrome Frame, взрывные 50 см макс, 10 Вт светодиод	1+ O + F	[maggiorazione] supplement supplément Aufpreis дополнение	842	
• G) Retroilluminati, sabbatura cm 70 max, led 14 W Backlit mirrors, frame, frosted glass cm 70 max, led 14 W Miroirs avec la lumierer, cadre, en verre dépoli cm 70 max, led 14 W Spiegel mit integrierter LED-Leuchte, Rahmen verchromt, Milchglas cm 70 max, led 14 W Подсветка Chrome Frame, взрывные макс 70 см, Ш 14 LED	1+ O + G	[maggiorazione] supplement supplément Aufpreis дополнение	842	
• H) Retroilluminati, sabbatura cm 100 max, led 19,9 W Backlit mirrors, frame, frosted glass cm 100 max, led 19,9 W Miroirs avec la lumierer, cadre, en verre dépoli cm 100 max, led 19,9 W Spiegel mit integrierter LED-Leuchte, Rahmen verchromt Milchglas cm 100 max, led 19,9 W Подсветка Chrome Frame, взрывные макс 100 см, Ш 19,9 LED	1+ O + H	[maggiorazione] supplement supplément Aufpreis дополнение	842	
• i) Retroilluminati, sabbatura superiore a cm 100, led 19,9 W Backlit mirrors, frame, frosted glass cm 100 max, led 19,9 W Miroirs avec la lumierer, cadre, en verre dépoli cm 100 max, led 19,9 W Spiegel mit integrierter LED-Leuchte, Rahmen verchromt Milchglas cm 100 max, led 19,9 W Подсветка Chrome Frame, взрывные более 100 см, ширина 19,9 LED	1+ O + i	[maggiorazione] supplement supplément Aufpreis дополнение	842	
• J) Retroilluminati, doppia sabbatura verticale cm 50 max, led 19,9 W Backlight mirrors, frame, double vertical frosted glass cm 50 max, led 19,9 W Miroirs avec la lumierer, cadre, en verre dépoli vertical cm 50 max, led 19,9 W Spiegel so Hintergrundbeleuchtung, Halterung, Milchglas cm 50 max, led 19,9 W Зеркало со встроенной LED подсветкой 19,9 Вт, с хромированной окантовкой	1+ O + J	[maggiorazione] supplement supplément Aufpreis дополнение	1115	
• K) Retroilluminati cornice cromata, spot led, 3,5 W c.d., Ø 35 mm Backlight mirrors, frame, 3 spot led, 3,5 W c.d., Ø 35 mm Miroirs avec la lumierer, cadre, 3 spot led, 3,5 W, 3,5 W c.d., Ø 35 mm Spiegel mit Hintergrundbeleuchtung, Halterung 3 spot led, 3,5 W, 3,5 W c.d., led 19,9 W, Ø 35 mm Зеркало с подсветкой сзади, 3 LED режима, с хромированной окантовкой, Ø 35 mm	1+ O + K	[maggiorazione] supplement supplément Aufpreis дополнение	1116	
• L) Retroilluminati, punti POWER LED 3 W c.d., Ø 10 mm Backlit mirrors, frame, 6 POINT POWER LED, led 3 W c.d., Ø 10 mm Miroirs avec la lumierer, cadre, poli cm 6 POINTS POWER LED 3 W c.d., Ø 10 mm Spiegel mit Hintergrundbeleuchtung, Halterung, 6 Punkte Power LED, led 3 W c.d., Ø 10 mm подсветкой, хромированная рама, 6 точек POWER LED 3 W c.d., Ø 10 mm	1+ O + L	[maggiorazione] supplement supplément Aufpreis дополнение	1055	
• M) LED perimetrale, con canalina protetta montata a filo specchio (per mt) LED perimeter with frame protected, mounted mirror wire (for mt) Périmètre LED avec cadre de protection, fil de miroir monté (pour mt) LED seitlich, mit integrierter satiniertes abdeckung, amrand LED по периметру, с изоляционной защитой, установленной заподлицо зеркала	1+ O + M	[maggiorazione] supplement supplément Aufpreis дополнение	948	
• N) LED perimetrale, con canalina protetta montata 3 cm interno specchio (per mt) LED perimeter with frame protected mounted 3 cm interior mirror (for mt) Périmètre LED avec cadre de protection monté de 3 cm de intérieur de miroir (pour mt) LED seitlich, mit integrierter satiniertes abdeckung, amrand 3 cm rahmen-rudsprung (pro mt) LED по периметру, с изоляционной защитой, установленной 4 см внутри зеркала (на метр)	1+ O + N	[maggiorazione] supplement supplément Aufpreis дополнение	1159	

• X)	Luce perimetrale con sabiatura esterna 4 cm (per mt) Perimeter light with external sanding 4 cm (for mt) Lumière périmétrique avec ponçage extérieur 4 cm (pour mt) Begrenzungsleuchte mit Außenschliff 4 cm (pro mt) Периметровое освещение с внешней пескоструйной обработкой 4 см (на метр)	1 + 0 + X	[maggiorazione] supplément supplément Aufpreis дополнение	
• Y)	Luce perimetrale con sabiatura 3cm, interno specchio 7 cm (per mt) Perimeter light with 3cm sanding, inside mirror 7 cm (per mt) Lumière périmétrique avec ponçage de 3 cm, miroir intérieur de 7 cm (par mt) Begrenzungsleuchte mit 3-cm-Schliff, Innenspiegel 7 cm (pro mt) Светильник по периметру с 3 см шлифовкой, внутреннее зеркало 7 см (на метр).	1 + 0 + Y	[maggiorazione] supplément supplément Aufpreis дополнение	
• CCO)	Sabiatura costa a costa (non prevede N/M) Coast to coast sandblasting (no N/M) Sablage de côte à côte (pas de N/M) Sandstrahlen von Küste zu Küste (kein N/M) Пескоструйная очистка от берега до берега (нет Н/М)	1 + 0 + F + CCO	[maggiorazione] supplément supplément Aufpreis дополнение	

OPZIONI / OPTION / OPTIONS / OPTIONEN / ВАРИАНТЫ

• P)	Interruttore a sfioramento per specchi (distanza superiore a 15 cm da parete) Touchless switch for mirrors (distance greater than 15 cm from wall) Interrupteur tactile pour miroirs (distance supérieure à 15 cm du mur) Touch-Schalter für Spiegel (Abstand größer als 15 cm von der Wand) Сенсорный выключатель для зеркала (на расстоянии более 15 см от стены)		[maggiorazione] supplément supplément Aufpreis дополнение	
• V)	Interruttore touch su specchio Touch switch on mirror Interrupteur tactile sur le miroir Berührungsschalter am Spiegel Сенсорный выключатель на зеркале		[maggiorazione] supplément supplément Aufpreis дополнение	
• V2)	Doppio interruttore (1 dimerabile + 1 On/Off) Double switch (1 dimmable + 1 On/Off) Double interrupteur (1 gradable + 1 On/Off) Doppelter Schalter (1 dimmbar + 1 ein/aus) Двойной выключатель (1 диммируемый + 1 вкл/выкл)		[maggiorazione] supplément supplément Aufpreis дополнение	
• Q)	Resistenza antiappannamento per specchi (superiori a 120cm si consigliano 2 resistenze) - specificare modalità di accensione Anti-fog resistance for mirrors (more than 120cm, 2 heating elements are recommended) - specify ignition mode Résistance anti-buée pour les miroirs (plus de 120cm, 2 éléments chauffants sont recommandés) - spécif spécif spécif mode d'allumage Anti-Beschlag für Spiegel (mehr als 120cm, 2 Heizelemente werden empfohlen) - Zündungsmodus angeben функция антизапотевания (более 120 см, рекомендуется использовать 2 нагревательных элемента) - укажите режим зажигания		[maggiorazione] supplément supplément Aufpreis дополнение	
• R)	Specchio ingranditore integrato sul vetro per specchi Magnifying mirror integrated in the mirror Miroir grossissant intégré dans le miroir Vergrößerungsspiegel in den Spiegel integriert Увеличительное зеркало, встроенное на поверхность зеркала длиной		[maggiorazione] supplément supplément Aufpreis дополнение	
• S)	Specchio ingranditore RETROILLUMINATO integrato sul vetro per specchi Magnifying mirror integrated in the mirror Miroir grossissant intégré dans le miroir Vergrößerungsspiegel in den Spiegel integriert Увеличительное зеркало с подсветкой, встроенное на поверхность зеркала длиной		[maggiorazione] supplément supplément Aufpreis дополнение	

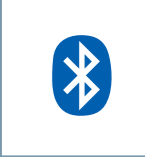
• U)	Impianto bluetooth senza comandi con specchio retroilluminato bluetooth plants without controls with back light mirror bluetooth système sans commandes avec des miroirs rétro-éclairés Bluetooth-Anlage ohne Bedienungseinheit система bluetooth без команд с зеркалом с подсветкой	[maggiorazione] supplément supplément Aufpreis дополнение	
	Impianto bluetooth senza comandi per specchio senza illuminazione (fornito con alimentatore) bluetooth plants without controls with mirror without illumination (supplied with power supply) bluetooth système sans commandes avec miroir d'éclairage (fourni avec l'alimentation) Bluetooth-Anlage ohne Bedienungseinheit für Spiegel ohne Beleuchtung система bluetooth без команд для зеркал без подсветки (поставляется вместе с блоком питания)	[maggiorazione] supplément supplément Aufpreis дополнение	

IMBALLI - Per spedizioni si provvederà al recupero in fattura di:

netti a specchio per misure fino cm150
netti a specchio per misure superiori cm 150

PACKAGING - For shipments of mirrors we will debit:

as extra packing contribution for mirror under cm 150.
as extra packing contribution for mirror over cm 150.

EMBALLAGE - Dans les livraisons des miroirs nous allons debiter en facture:





net sous titre de fret d'emballage special dessous cm 150.
net sous titre de fret d'emballage special dessus cm 150.

AUFSCHLAG FÜR SPIEGEL - Sonderverpackungen:

netto Sonderverpackungen unter 150 cm
netto Sonderverpackungen über 150 cm

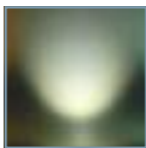
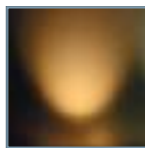
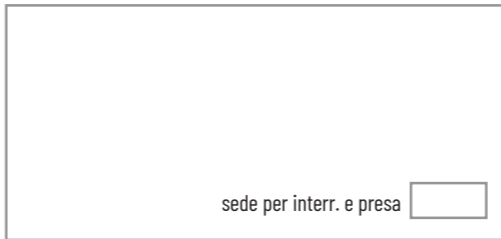
Упаковка - для перевозок мы добавляем в счет:

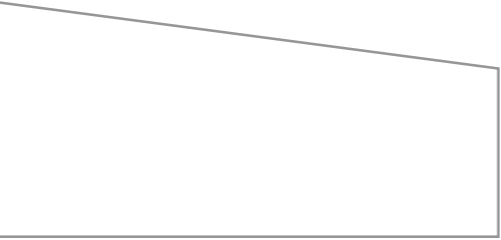
евро нетто для зеркал размером до 150 см
10 евро нетто для зеркал размером более 150 см

	LED 4000 K		LED 2700 K	SU RICHIESTA on demand Sur demande Auf Anfrage По запросу
	sede per interr. e presa			
1. Specchio con sede per interruttore a parete Mirror with seat for wall switch Miroir avec siège pour interrupteur mural Spiegel mit Sitz für Wandschalter Зеркало с сиденьем для настенного выключателя Maggiorazione supplément / supplément / Aufpreis / дополнение		2. Specchio con scasso per interruttore a parete Mirror with burglary for wall switch Miroir avec cambriolage pour interrupteur mural Spiegel mit Einbruchschutz für Wandschalter Зеркало со взломом для настенного выключателя Maggiorazione supplément / supplément / Aufpreis / дополнение		
		3. Specchio con angolo arrotondato R5 Mirror with rounded corner R5 Miroir avec coin arrondi R5 Spiegel mit abgerundeter Ecke R5 Зеркало с закругленным углом R5 Maggiorazione supplément / supplément / Aufpreis / дополнение		
				
3. Specchio con Taglio inclinato Mirror with inclined cut / Miroir à coupe inclinée Spiegel mit schrägem Schnitt / Зеркало с наклонным разрезом Maggiorazione supplément / supplément / Aufpreis / дополнение		4. Foro su specchio Ø 12 Hole on mirror Ø 12 / Trou sur le miroir Ø 12 Bohrung am Spiegel Ø 12 / Отверстие на зеркале Ø 12 Maggiorazione supplément / supplément / Aufpreis / дополнение		



Entra nel configuratore Scegli la proposta
Clicca su specchi e segui le richieste:

- Tipo Vetro
- Dimensioni
- Luce Interna
- Cornice
- Tipo Luce Interna
- Sabbatura Costo to Cost
- Posizione Sabbatura
- Opzioni
- Colore Led
- Lampade
- Luci per Specchi

Enter the configurator choose the proposal
click on mirrors and follow the requests:

- glass type
- dimensions
- interior light
- frame
- internal light type
- sandblasting cost to cost
- sandblasting position
- options
- led color
- lamps
- mirror lights

Entrez dans le configurateur Choisissez votre proposition
Cliquez sur les miroirs et suivez les instructions :

- Type de verre
- Dimensions
- Lumière interne
- Cadre
- Type de lumière interne
- Sablage Coût à Coût
- Position Sandblasting
- Options
- Couleur Led
- Lampes
- Miroir lumineux

Zugang zum Konfigurator Wählen Sie Ihren Vorschlag
Klicken Sie auf Spiegel und folgen Sie den Anweisungen:

- Glas Typ
- Abmessungen
- Internes Licht
- Rahmen
- Interner Lichttyp
- Sandstrahlen Kosten zu Kosten
- Position Sandstrahlen
- Optionen
- Led Farbe
- Lampen
- Spiegel Lichter

Войдите в конфигуратор Выберите свое предложение
Нажмите на зеркала и следуйте требованиям:

- Тип стекла
- Размеры
- Внутренний свет
- Рама
- Тип внутреннего освещения
- Пескоструйная обработка Стоимость к стоимости
- Положение Пескоструйная обработка
- Опции
- Цвет светодиодов
- Лампы
- Зеркальные лампы

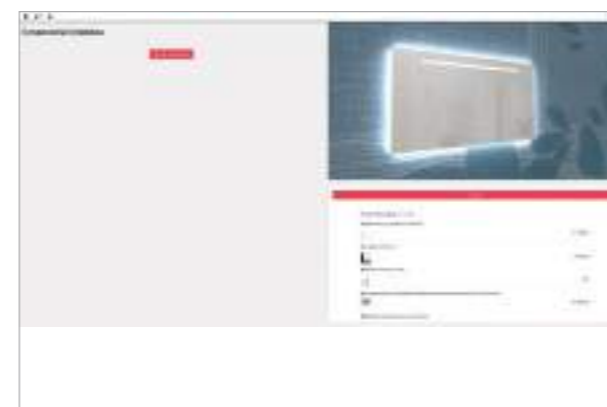
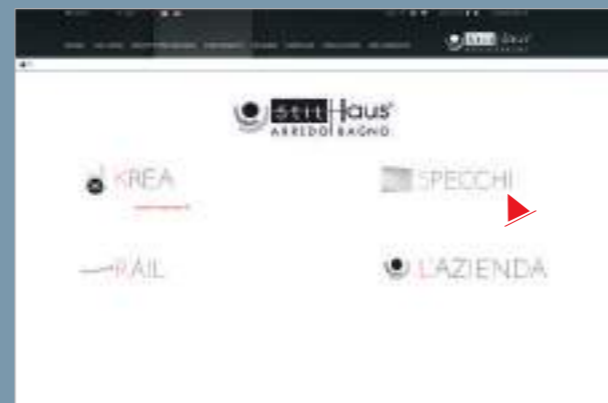

Al termine della configurazione, cliccando sul carrello potrete visionare le opzioni richieste ed il prezzo di listino.

At the end of the configuration, by clicking on the cart you can check the required options and the list price.

À la fin du processus de configuration, cliquez sur le panier pour afficher les options requises et le prix catalogue.

Klicken Sie am Ende des Konfigurationsprozesses auf den Warenkorb, um die gewünschten Optionen und den Listenpreis anzuzeigen.

В конце процесса настройки нажмите на корзину, чтобы просмотреть необходимые опции и прейскурантную цену.

Indica:

- Privato: richiesta punto vendita in azienda
- Preventivo: invio mail preventivo
- Ordine rivenditore: inserimento ordini

Zeigt an:

- Privat: Anfrage zur Verkaufsstelle im Unternehmen
- Angebot: Angebot per E-Mail senden
- Bestellung des Einzelhändlers: Auftragserteilung

Indicate:

- private: you can ask your nearest stilhaus shop
- quotation: ask a quotation directly to our company
- Retailer order: placing orders as direct already registered customer

Указывает:

- Частное лицо: запрос торговой точки в компании
- Предложение: отправить предложение по электронной почте
- Заказ розничного продавца: размещение заказа

Indique :

- Privé : demande de point de vente en entreprise
- Devis : envoyer un devis par courriel
- Commande du détaillant : passation de commande

Pour commander, veuillez remplir les champs :

- Numéro de TVA.
- Numéro de client (exemple : 0001111) que vous pouvez trouver dans nos confirmations de commande précédentes, pour les nouveaux clients, veuillez demander dans l'entreprise.
- Votre adresse électronique.
- Des notes.
- La commande sera saisie directement dans notre système de gestion pour votre confirmation ultérieure.

Um zu bestellen, füllen Sie bitte die Felder aus:

- Umsatzsteuer-Identifikationsnummer.
- Kundennummer (Beispiel: 0001111), die Sie in unseren bisherigen Auftragsbestätigungen finden, bei Neukunden bitte in der Firma erfragen.
- Ihre E-Mail Adresse.
- Irgendwelche Notizen.
- Die Bestellung wird direkt in unser Verwaltungssystem eingegeben und von Ihnen bestätigt.

Для заказа, пожалуйста, заполните поля:

- Номер НДС.
- Номер клиента (пример: 0001111), который вы можете найти в наших предыдущих подтверждениях заказов, для новых клиентов, пожалуйста, спросите в компании.
- Ваш адрес электронной почты.
- Любые замечания.
- Заказ будет введен непосредственно в нашу систему управления для последующего подтверждения.

Per ordine, compilare i campi:

- Partita Iva.
- Numero cliente(esempio: 0001111) che potete trovare nelle nostre conferme ordine precedenti, per i nuovi clienti, chiedere in azienda.
- Vostro indirizzo e-mail.
- Eventuali note.
- L'ordine verrà inserito direttamente nel nostro gestionale per Vs successiva conferma.

Fill in the fields to order:

- vat number
- customer number (example: 0001111) that you can find in our previous order confirmations, for new customers, ask the company
- your e-mail address
- possible notes
- the order will be placed directly in our management system for your subsequent confirmation.

ILLUMINAZIONE

_OLTRE GLI ASTRIS

Designer: Stilhaus
Fuori misura: Sì
I prezzi delle illuminazioni a bassa tensione (12V) comprendono il costo dei trasformatori.
RAEE: Iscr. Al Registro A.E.E. n. IT 3110000008191,
i prezzi delle illuminazioni non comprendono il contributo

Designer: Stilhaus
Customized: Yes
The prices of the low-voltage halogen lights (12V) include the cost of the transformers.
RAEE: Iscr. Register to A.E.E. n. 3110000008191 IT,
prices do not include the contribution of the illuminations

Designer: Stilhaus
Personnalisé: Oui
Les prix des lampes halogènes basse tension (12V) comprennent le coût des transformateurs.
RAEE: Iscr. Inscrivez-vous pour A.E.E. n. 3110000008191 IT,
prix ne comprennent pas la contribution des illuminations

Designer: Stilhaus
Kundenwunsch: Ja
Die Preise für die Niedervolt-Halogenlampen (12 V) sind die Kosten der Transformatoren.
RAEE: Iscr. Registrieren A.E.E. n. 3110000008191 IT,
Preise ohne Leuchtmittel

Разработка дизайна: Stilhaus
Негабаритный: да
Цены на низковольтных галогенных ламп (12V) включают в себя стоимость трансформаторов.
RAEE: ISCR. Зарегистрируйся, чтобы A.E.E. н. 3110000008191 IT,
Цены не включают вклад иллюминации



D 5 Lampada abbinabile ad interruttori (V) - (V2) - (P)



ILLUMINAZIONE

EL 17 ELITE

Plafoniera in vetro satinato
Ceiling lamp
Plafonnier
Deckenleuchte
Светильник матовое стекло

cm Ø 40

CE: V 220 40Wx2

- 08

- 16 - 25 - 26



692

Plafoniera vetro sabbato
Ceiling lamp
Plafonnier
Deckenleuchte
Люстра в латуневым обрамлении

cm Ø 34 x 14 H

CE: V 220 IP20 40Wx2

- 08

- 02

- 16 - 25 - 26 - 36

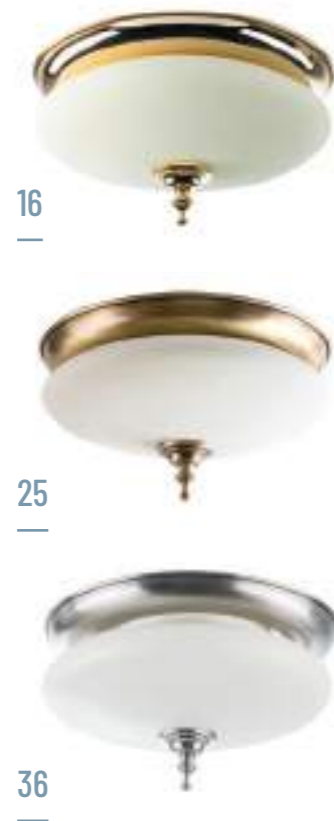

ILLUMINAZIONE

991 NE

Lampadario con paralume tessuto nero
Brass chandelier with black fabric lampshade
Lustre en laiton avec abat-jour tissu noir
Hängeleuchte mit Lampenschirm aus schwarzem Stoff

Латунная люстра с тремя лампами и абажуром (модель)

cm Ø 32 x 74 H

CE: V 220 IP20 60Wx1

- 08

- 16 - 25

991 BI

Lampadario con paralume tessuto bianco
Brass chandelier with white fabric lampshade
Lustre en laiton avec abat-jour tissu blanc
Hängeleuchte mit Lampenschirm aus weißem Stoff

Латунная люстра с тремя лампами и абажуром (модель)

cm Ø 32 x 74 H

CE: V 220 IP20 60Wx1

- 08

- 16 - 25



i 24 IDRA

Lampadario in ottone paralume P
Brass chandelier lampshade p.
Lustre en laiton abojour p.
Hängeleuchte aus Messing Lampenglas p.

Латунная люстра с тремя лампами и абажуром (модель B)

cm Ø 50 x 68 H

CE V 220 IP20 40Wx3

- 08

- 16 - 25



> PAG. 305

ILLUMINAZIONE

1134 SP

Applique per specchio a led
Led mirror lamp
Lampe a Led pour miroir
LED Leuchte für Spiegel
Светодиодный настенный
светильник для зеркала

cm 30 L x 11 P x 4,5 H

CE: V 220 IP 44 4,8W 4000K



- 08

- 23

- 3000K *maggiorazione supplement*
supplément/Zuschlag
дополнительно



1134 SP

1135 SP

Applique per specchio a led
Led mirror lamp
Lampe a Led pour miroir
LED Leuchte für Spiegel
Светодиодный настенный
светильник для зеркала

cm 45 L x 11 P x 5 H

CE: V 220 IP44 8W a 12 Vdc 4000K



1135 SP

1136 SP

Applique per specchio a led
Led mirror lamp
Lampe a Led pour miroir
LED Leuchte für Spiegel
Светодиодный настенный
светильник для зеркала

cm 56 L x 15 P x 4 H

CE: V 220 IP44 8W a 12 Vdc 4000K



1136 SP

ILLUMINAZIONE

1104 SP LED

Applique per specchio a LED
Applique for mirror LED
Applique pour miroir LED
Leuchte für Spiegel LED
Верхний светильник
для зеркала LED

cm 34,5 L x 9 P x 4 H

CE: V 220 IP44 9W 4000K



- 08

1104 SP

1105 SP LED

Applique per specchio LED
Applique for mirror LED
Applique pour miroir LED
Leuchte Spiegel LED
Верхний светильник
для зеркала LED

cm 55,5 L x 9 P x 4 H

CE: V 220 IP44 15W 4000K



- 08

1105 SP

1277 SP LED

Applique per specchio a LED
Led mirror lamp
Lampe a Led pour miroir
LED Leuchte für Spiegel
Светодиодный настенный
светильник для зеркала

cm 40 L x 5 P x 2 H

CE: V 220 IP44 15W 4000K



- 08

1277 SP

ILLUMINAZIONE

1245 SP LED

Applique LED per specchio
Led mirror lamp
Lampe a Led pour miroir
LED Leuchte für Spiegel
Светодиодный настенный
светильник для зеркала
cm 20 L x 4 P x 4 H
CE : V 220 IP44 LED 7W a 12 Vdc 4000K



1245 SP

1110 SP

Applique per specchio a led
Led mirror lamp
Lampe a Led pour miroir
LED Leuchte für Spiegel
Светодиодный настенный
светильник для зеркала
cm 7,5 L X 10,5 P X 29 H
CE : V 220 IP 44 69 3W 3000K



- 08
- 23



1110

1108 SP LED

Applique LED per specchio
Led mirror lamp
Lampe a Led pour miroir
LED Leuchte für Spiegel
Светодиодный настенный
светильник для зеркала
cm 20 L x 4 P x 4 H
CE : V 220 IP23 LED 6W a 12 Vdc 6000K



1108 SP



1060

ILLUMINAZIONE

1060 CALAMITA

Applique per specchio a led calamitata
Led mirror lamp magnetized
Lampe a Led pour miroir magnétisé
LED Leuchte für Spiegel magnetisiert
Светодиодный настенный
светильник для зеркала
cm Ø 8 x 4 H

CE : V 220 5 W 4000K

- 08 - CAVO ROSSO - RED WIRE
- 08 - CAVO NERO - BLACK WIRE

1198

Lampada per specchio forato Ø 10
Led mirror lamp
Lampe a Led pour miroir
LED Leuchte für Spiegel
Светодиодный настенный
светильник для зеркала
cm 7,5 L X 10,5 P X 29 H



CE : V 220 IP 44 69 3W 3000K

- 08

Foro su specchio / Hole on mirror /
Troudanslemiroir/LochimSpiegel/
Отверстие на зеркале

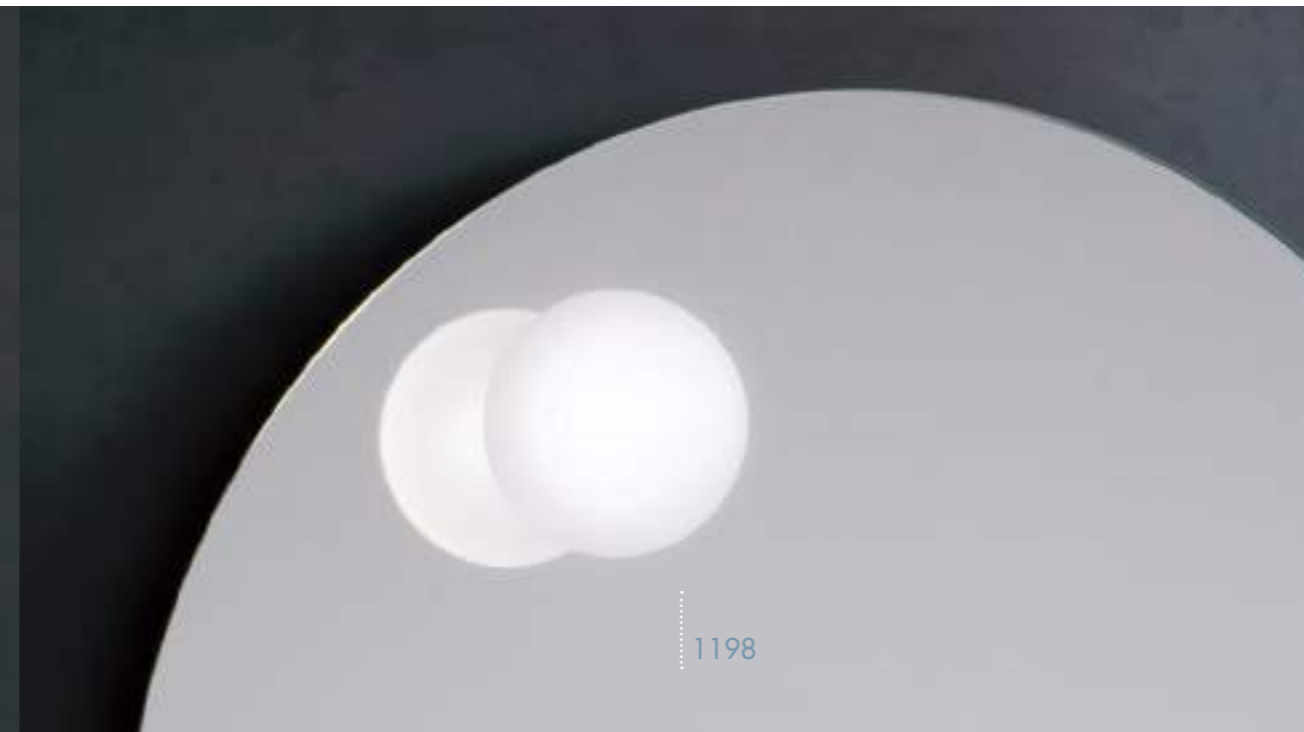

1198

1103 SP LED

Applique LED per specchio
Led mirror lamp
Lampe a Led pour miroir
LED Leuchte für Spiegel
Светодиодный настенный
светильник для зеркала
cm 11 L x 7,5 P x 7 H



CE : V 220 IP 20 4,8W 4000K

- 08



1103 SP

ILLUMINAZIONE

973 sp

Applique per specchio alogena
Applique for mirror
Applique pour miroir
Leuchte Spiegelleuchte
Верхний светильник
для зеркала

cm 28 L x 14 P x 8 H

CE: V 220 IP44 G9 33Wx2

- 08



973 SP

RL 03

Applique per specchio
Applique for mirror
Applique pour miroir
Leuchte für Spiegel
Верхний светильник
для зеркала

cm 60 L x 3 P x 3 H

CE: V 220 IP44 7,9 W 4000K

- 08 - 09

- 36



RL 03

1228 SP LED

Applique per specchio LED
Applique for mirror LED
Applique pour miroir LED
Leuchte für Spiegel LED
Верхний светильник
для зеркала LED

cm 57 L x 3 P x 3 H

CE: V 220 IP44 4000K

• 1228 sp /50 - cm 50 L - W 7

• 1228 sp /70 - cm 70 L - W 10

• 1228 sp /90 - cm 90 L - W 12,5



1228 SP

SU MISURA - 14W x mt

• 1228 SP /FM*

ESEMPIO

1228 SP/FM cm 120 L

1228 SP/FM cm 175 L

* DISPONIBILE IN 20 GG.
Available in 20 days
Disponible en 20 jours
Verfügbar in 20 Tagen
Доступно через 20 дней

ILLUMINAZIONE

B 03 SP

Applique per specchio paralume M
Applique for mirror, lampshade M
Applique pour miroir abat-jour M
Leuchte für Spiegel, Lampenglass M
Настенный светильник
с абажуром регулируемый

cm 5 L x 10 P x 20 H

CE: V 220 IP44 40Wx1

- 08



B 03 SP

502

Applique per specchio con trasformatore
Applique with fixing for mirror and transformer
Applique pour miroir avec transformateur
Leuchte für Spiegel mit Transformator
Верхний бра с трансформатором

cm 6 L x 2,5 P

CE: V 220/12V - IP20 - 20Wx2

- 08



502



> PAG. 305



1164 SP

1064 SP LED

Applique per specchio orientabile
Applique with fixing for mirror adjustable
Applique pour miroir réglable
Leuchte für Spiegel verstellbar
Верхний светильник для зеркала

cm 37 L x 11 P x 3 H

CE: V 220 IP44 G9 3W x 2 3000K

- 08

- 16 - 25 - 26



ILLUMINAZIONE

1134

Applique LED a parete
Wall mounted LED applique
Applique à mur à LED
LED Wandleuchte
Настенные светильники светодиодный
cm 30 L x 10 P x 8 H
CE : V220 IP44 LED 4,8W/12V 4000K

• 08
• 23
• 3000K maggiorazione supplement
supplément/Zuschlag
дополнительно



LED

1134

1135

Applique LED a parete
Wall mounted LED applique
Applique à mur à LED
LED Wandleuchte
Настенные светильники светодиодный
cm 45 L x 15 P x 8 H
CE : V220 IP44 LED 7,9 W/12V 4000K

• 08



LED

1135

1104

Applique LED a parete
Wall mounted LED applique
Applique à mur à LED
LED Wandleuchte
Настенные светильники светодиодный
cm 34,5 L x 9 P x 8 H
CE : V220 IP20 LED 9,6W/12V 4000K

• 08



LED

1104

1105

Applique LED a parete
Wall mounted LED applique
Applique à mur à LED
LED Wandleuchte
Настенные светильники светодиодный
cm 55 L x 9 P x 8 H
CE : V220 IP20 LED 12,5W/12V 4000K

• 08



LED

1105

ILLUMINAZIONE

1061

Applique LED a parete
Wall mounted LED applique
Applique à mur à LED
LED Wandleuchte
Настенные светильники светодиодный
cm 55 L x 4 P x 5,5 H
CE : V220 IP23 LED 9,6W/12V 4000K

• 54



1061

992

Applique LED a parete
Wall mounted LED applique
Applique à mur à LED
LED Wandleuchte
Настенные светильники светодиодный
cm 50 L x 4 P x 10 H
CE : V220 IP23 LED 8W/12V 4000K

• 08

• 16 - 25



992

16

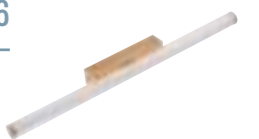

25

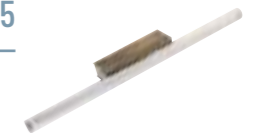

ILLUMINAZIONE

973

Applique a parete alogena
Wall mounted applique
Applique à mur
Wandleuchte
Верхний светильник для зеркала с фиксацией
cm 28 L x 14 P x 12 H
CE: V 220 IP44 G9 33Wx2

• 08



973

848

Applique a parete paralume P
Wall mounted applique lampshade P
Applique à mur abat-jour P
Wandleuchte Lampenglas P
Верхний светильник для зеркала P
cm 11 L x 14 P x 23 H
CE: V 220 IP44 40Wx1

• 08

• 16 - 25



> PAG. 305



848



1064

1064 LED

Applique orientabile a LED
Adjustable applique LED
Applique réglable LED
Wandleuchte verstellbar LED
Регулируемый настенный светильник с абажуром LED
cm 37 L x 22 P x 17 H
CE: V 220 IP44 G9 3W x 2 3000K

• 08

• 16 - 25 - 26



1100



1108

1100

Applique LED a parete
Wall mounted LED applique
Applique à mur à LED
LED Wandleuchte
Настенные светильники светодиодный
cm 7,5 L x 10,5 P x 29 H
CE: V220 IP44 G9 3W 3000K

• 08

• 23

913 NUVOLA

Applique a parete
Wall mounted applique
Applique à mur
Wandleuchte
Настенные светильники
cm 25 L x 8 P x 20 H
CE: V 220 IP20 G9 35Wx2

• 08

1108

Applique LED a parete
Wall mounted LED applique
Applique à mur à LED
LED Wandleuchte
Настенные светильники светодиодный
cm 20 L x 12 P x 8 H
CE: V220 IP23 LED 6,5W/12V 4000K

• 08



913.08



1162



774



1062



1062 SL

1162 MOON 1

Applique a parete
Wall mounted applique
Applique à mur
Wandleuchte
Верхний светильник для зеркала с фиксацией
cm 10 L x 13 P x 10 H
CE: V 220/12v IP44 G9 3W 3000K

- 08 - 23
- 16 - 25

774 MOON 2

Applique a parete
Wall mounted applique
Applique à mur
Wandleuchte
Верхний светильник для зеркала с фиксацией
cm 10 L x 15 P x 15 H
CE: V 220/12v IP44 G9 3W 3000K

- 08

B 03

Applique a parete paralume M
Wall mounted applique, lampshade M
Applique à mur, abat-jour M
Wandleuchte Lampenglas, Lampenglass M
Настенный светильник с абажуром регулируемый
cm 10 L x 10 P x 20 H
CE: V 220 IP44 60Wx1

- 08



B 03



504

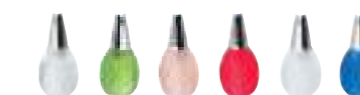

> PAG. 315

1062 LED

Applique a parete
Wall mounted applique
Applique à mur
Wandleuchte
Настенные светильники
cm Ø 10 x 19 P x 20 H
CE: V 220 IP44 G9 3W 3000K

- 08
- 16 - 25

1062 SL LED

Applique a parete con finale cristallo
Wall sconce with crystal finish
Applique murale avec finition en cristal
Wandleuchter mit Kristall-Finish
Настенный брашлет с хрустальной отделкой
cm Ø 10 x 19 P x 20 H
CE: V 220 IP44 G9 3W 3000K

- 08
- 16 - 25

504

Applique alogena
Applique alogen
Applique halogène
Wandleuchte Halogenlampen
Настенный светильник с регулируемой лампой
cm Ø 10
CE: V 220/12v IP20 G4 20Wx3

- 08

ILLUMINAZIONE

EL 03 ELITE

Applique a parete, paralume P
Wall mounted applique, lampshade P
Applique à mur, abat-jour P
Wandleuchte, Lampenglass P
Настенные лампы с абажуром
cm 14 L x 15 P x 15 H

CE: V 220 IP44 40Wx1

- 08
- 02 - 03 - 04
- 16 - 25 - 26



EL 03.2 ELITE

Applique doppia, paralume P
Applique with 2 lamps, lampshade P
Applique avec 2 lampe, abat-jour P
Wandleuchte doppelt, Lampenglass P
Настенные 2 лампы с абажуром
cm 36 L x 15 P x 16 H

CE: V 220 IP44 40Wx2

- 08
- 02
- 16 - 25 - 26



B C D



E I > PAG. 305



ILLUMINAZIONE

i 824 IDRA LED

Applique a parete
Wall mounted applique
Applique à mur
Wandleuchte
Настенный светильник с абажуром
cm 10 L x 24 P x 22 H

CE: V 220 IP44 G9 3W 3000K

- 08
- 16 - 25



i 03 IDRA

Applique a parete paralume B
Wall mounted applique, lampshade B
Applique à mur, abat-jour B
Wandleuchte Lampenglas, Lampenglass B
Настенный светильник с абажуром
cm 10 L x 24 P x 22 H

CE: V 220 IP44 40Wx1

- 08
- 16 - 25



ILLUMINAZIONE

915 NE

Applique a parete
Wall mounted applique
Applique à mur
Wandleuchte
Настенные светильники
cm 15 L x 15 P x 24 H
CE: V 220 IP44 40Wx1

• 08
• 16 - 25

915 BI

Applique a parete
Wall mounted applique
Applique à mur
Wandleuchte
Настенные светильники
cm 15 L x 15 P x 24 H
CE: V 220 IP44 40Wx1

• 08
• 16 - 25

1125 BI

Applique a parete ventola bianco
Wall mounted applique
Applique à mur
Wandleuchte
Настенные светильники
cm 9 L x 15 P x 26 H x 22 B
CE: V 220 IP20 40Wx1

• 08
• 16 - 25

1125 VE

Applique a parete ventola verde
Wall mounted applique
Applique à mur
Wandleuchte
Настенные светильники
cm 9 L x 15 P x 26 H x 22 B
CE: V 220 IP20 40Wx1

• 08
• 16 - 25

K 03.S

Applique orientabile paralume Z
Adjustable applique, lampshade Z
Applique réglable, abat-jour Z
Wandleuchte verstellbar, Lampenglass Z
Регулируемый настенный светильник с абажуром
cm 10 L x 22 P x 17 H
CE: V 220 IP20 40Wx1

• 08
• 02
• 16 - 25 - 26 - 36

314_ILLUMINAZIONE



915 NE



915 BI



K 03.S



1125 BI



1125 VE

MOD. B

Vetro sabbato
Sand glass
Verre sablé
Milchglas
Абажур (матовое стекло)
cm Ø 13 x 10 P

• B



MOD. C

Vetro sabbato con decoro a rilievo
Sand glass with decoration to relief
Verre sablé avec décoration à relief
Milchglas mit Dekor und Relief
Абажур (матовое стекло с рельефным украшением)
cm Ø 15 x 10 P

• C

• Con applique (maggiorazione)
With applique (supplement)
Avec applique (supplément)
Mit Wandleuchte (Zuschlag)
С аппликацией (за дополнительную плату)



MOD. D

Vetro sabbato con decoro a rilievo rosa
Sand glass with pink decoration to relief
Verre sablé avec décoration rose à relief
Milchglas mit Dekor und Relief rosa
Абажур (матовое стекло с рельефным розовым украшением)
cm Ø 15 x 10 P

• D - Rosa / pink / rose / rosa

• Con applique (maggiorazione)
With applique (supplement)
Avec applique (supplément)
Mit Wandleuchte (Zuschlag)
С аппликацией (за дополнительную плату)



MOD. E

Vetro sabbato con decoro a rilievo verde
Sand glass with green decoration to relief
Verre sablé avec décoration vert à relief
Milchglas mit Dekor und grünem Relief
Абажур (матовое стекло с рельефным зелёным украшением)
cm Ø 15 x 10 P

• D - Verde / green / vert / grün

• Con applique (maggiorazione)
With applique (supplement)
Avec applique (supplément)
Mit Wandleuchte (Zuschlag)
С аппликацией (за дополнительную плату)



MOD. Z

Vetro satinato
Satinated glass
Verre satiné
Satiniertes Glas
Абажур матовое стекло
cm Ø 13 x 10 P

• Z

MOD. I

Ceramica bianca
White ceramic
Céramique blanc
Weiße Keramik
белый керамический
cm Ø 15 x 10 P

• Bianco / white / blanc / weiß / белый

• Con applique (maggiorazione)
With applique (supplement)
Avec applique (supplément)
Mit Wandleuchte (Zuschlag)
С аппликацией (за дополнительную плату)

MOD. P

Vetro satinato con bordo trasparente
Satinated glass with transparent edge
Verre satiné avec bord transparent
Satiniertes Glas mit transparentem Rand
Абажур матовое стекло
cm Ø 14 x 11 P

• P

• Con applique (maggiorazione)
With applique (supplement)
Avec applique (supplément)
Mit Wandleuchte (Zuschlag)
С аппликацией (за дополнительную плату)

MOD. U

Vetro di Murano in diversi colori
Murano's glass in various colors
Verre de Murant en divergés couleurs
Muranoglas in verschiedenen Farben
Мурано стекло различных цветов
cm Ø 3 x 4 H

• U

TERMOARREDI E PLACCHE

_CALDO BENESSERE

DesignDesigner: Stilhaus
Materiale: ottone, Tubo Ø28, basetta a muro Ø 70
Finitura: 08-16-25
Fuori misura: Sì
- in larghezza, con aumento del 10% dal prezzo di listino
- in altezza, a preventivo
- con aggiunta di elementi, a preventivo

Designer: Stilhaus
Material: Brass tube Ø 28, fixing plate cover Ø 70
Finishes: 08-16-25
Customized: Yes
- in width, with a 10% increase from the price list
- in height, to quote
- with the addition of element, to quote

Designer: Stilhaus
Matière: Laiton, tuyau Ø 28, boucle couvre-vis Ø 70
Finitions: 08-16-25
Personnalisé: Oui
- en largeur, avec une augmentation de 10% du prix de list
- hauteur, faire une estimation
- avec des éléments ajoutés, faire une estimation

Designer: Stilhaus
Material: Messing Rohr Ø28,Angriff Ø70
Zubehör: Mattglas
Ausführungen: 08-16-25
Kundenwunsch: Ja
- die Breite mit 10% Preisaufschlag
- die Höhe gegen Kostenvoranschlag
- zusätzliche Elemente gegen Kostenvoranschlag

Дизайн: Stil Haus
Материал: латунь
Варианты цвета: 08-16-25
Варианты под заказ:
По ширине, с увеличением на 10% от цены прайс-листа
по высоте, по запросу
с добавлением элементов, по запросу



1020

Scalda asciugamani in ottone a parete, versione acqua calda
 Brass wall towel warmer, hot water version
 Warmwasser-Wandhandtuchwärmer aus Messing, Warmwasser-Version
 Полотенцесушитель водяной, латунь
 Cm 60 H x 57 L x 14 P Int 50
 Δ 50°C 165 KCAL/H

- 08
- 25 - 16

1020 E

Scalda asciugamani in ottone a parete, versione elettrica 270 W
 Brass wall towel warmer, electric version 270 W
 Warmwasser-Wandhandtuchwärmer aus Messing, elektrische Version (270W)
 Полотенцесушитель электрический 270 W, латунь
 Cm 60 H x 57 L x 14 P Int 50
 Δ 50°C 180 W

- 08
- 25 - 16

1024

Valvola e detentore completi
 Valve and lockshield
 Ventile und Drossel
 клапана и вентеля в комплекте

- 08
- 25 - 16

1025

Tubetti di collegamento
 Connecting pipes
 Verbindungsstücke
 трубки для подключения

- 08
- 25 - 16

1026

Termostato
 Thermostat
 Thermostat
 Терморегулятор

- 01

1027

Cover con interruttore
 Cover with switch
 Couverture avec interrupteur
 Крышка с выключателем

- 08
- 25 - 16



1021

Scalda asciugamani in ottone a parete, versione acqua calda
 Brass wall towel warmer, hot water version
 Warmwasser-Wandhandtuchwärmer aus Messing, Warmwasser-Version
 полотенцесушитель водяной, латунь
 Cm 80 H x 57 L x 14 P Int 50
 Δ 50°C 270 KCAL/H

- 08
- 25 - 16

1021 E

Scalda asciugamani in ottone a parete, versione elettrica 270 W
 Brass wall towel warmer, electric version 270 W
 Warmwasser-Wandhandtuchwärmer aus Messing, elektrische Version (270W)
 полотенцесушитель электрический 270 W, латунь
 Cm 80 H x 57 L x 14 P Int 50
 Δ 50°C 285 W

- 08
- 25 - 16

1024

Valvola e detentore completi
 Valve and lockshield
 Ventile und Drossel
 клапана и вентеля в комплекте

- 08
- 25 - 16

1025

Tubetti di collegamento
 Connecting pipes
 Verbindungsstücke
 трубки для подключения

- 08
- 25 - 16

1026

Termostato
 Thermostat
 Thermostat
 Терморегулятор

- 01

1027

Cover con interruttore
 Cover with switch
 Couverture avec interrupteur
 Крышка с выключателем

- 08
- 25 - 16



1024

1025

ELITE

1022

Scalda asciugamani in ottone a parete, versione acqua calda
 Brass wall towel warmer, hot water version
 Warmwasser-Wandhandtuchwärmer aus Messing, Warmwasser-Version
 Полотенцесушитель водяной, латунь
 Cm 120 H x 57 L x 14 P Int 50
 Δ 50°C 345 KCAL/H

- 08
 - 25 - 16

1022 E

Scalda asciugamani in ottone a parete, versione elettrica 270 W
 Brass wall towel warmer, electric version 270 W
 Warmwasser-Wandhandtuchwärmer aus Messing, elektrische Version (270W)
 Полотенцесушитель электрический 270 W, латунь
 Cm 120 H x 57 L x 14 P Int 50
 Δ 50°C 360 W

- 08
 - 25 - 16

1024

Valvola e detentore completi
 Valve and lockshield
 Ventile und Drossel
 клапана и вентеля в комплекте

- 08
 - 25 - 16

1025

Tubetti di collegamento
 Connecting pipes
 Verbindungsstücke
 трубки для подключения

- 08
 - 25 - 16

1026

Termostato
 Thermostat
 Thermostat
 Терморегулятор

- 01

1027

Cover con interruttore
 Cover with switch
 Couverture avec interrupteur
 Крышка с выключателем

- 08
 - 25 - 16



TERMOARREDI SU MISURA



TERMO A

Scalda asciugamani BASE in ottone a parete
 BASE Brass wall towel warmer, hot water version
 Chauffe-serviettes BASE en laiton monté au mur
 Warmwasser-Wandhandtuchwärmer aus Messing, Warmwasser-Version
 Полотенцесушитель водяной, латунь
 Cm 50/ 120 H x 40 / 60 L x 10/ 14 P

- 08
 - 25 - 16



TERMO B

Tubo con giunti in ottone
 Pipe with brass joints
 Tube avec raccords en laiton
 Rohr mit Messingverbindungen
 Труба с латунными швами
 Cm 20 H min x 40 / 60 L

- 08
 - 25 - 16



TERMO H

Altezza superiore a cm 120
 Height greater than 120 cm
 Hauteur supérieure à 120 cm
 Höhe größer als 120 cm
 Высота более 120 см
 Cm 120/ 160 H x 40 / 60 L x 10/ 14 P

- 08
 - 25 - 16



TERMO EL

Resistenza elettrica
 Electrical resistance
 Résistance électrique
 Elektrischer Widerstand
 Электрическое сопротивление

- 08



1024

Valvola e detentore completi
 Valve and lockshield
 Ventile und Drossel
 клапана и вентеля в комплекте

- 08
 - 25 - 16



1025

Tubetti di collegamento
 Connecting pipes
 Verbindungsstücke
 трубки для подключения

- 08
 - 25 - 16



1027

Cover con interruttore
 Cover with switch
 Couverture avec interrupteur
 Крышка с выключателем

- 08
 - 25 - 16



1026

Termostato
 Thermostat
 Thermostat
 Терморегулятор

- 01

€

ESEMPIO

EXAMPLE Termoarredo 5 tubi cromo elettrico con cover Cm 95 H x 55 L
 EXEMPLE Chrome electric 5 tubes thermo-furnishing with cover
 EXEMPLE Chrome électrique 5 tubes thermo-aménagement avec couvercle
 BEISPIEL Verchromte elektrische 5-Röhren-Thermomöbel mit Deckel
 Пример Хромированный электрический 5-трубчатый радиатор с крышкой

A	TERMO A	08
B	TERMO B	08
A	TERMO EL	
A	1027	
		TOT



A

+



B

+



C

+

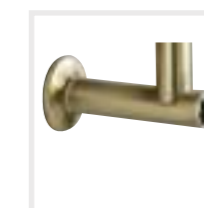

D

PLACCHE



1098

Placca comando per cassetta incasso mod. Geberit, compatibile con Unica+, Combifix e Duofix dotate del corpo cassetta UP320 o simili

Plate for Geberit Waste System featuring with Unica+, Combifix e Duofix that mounted body UP320 or similar

Drückerplatte für Geberit Installationssysteme (Unica+, Combifix und Duofix), die mit UP320 Kassettengehäuse oder ähnlichem ausgestattet sind.

Клавиша смыва для бачков скрытого монтажа Geberit с Unica+, Combifix e Duofix установленных в бачки UP320 или подобные

cm 33LxP2,5xH17

• 08 - cromo / chrome / chrome / chrom / хром



1098

Placca comando per cassetta incasso mod. Geberit, compatibile con Unica+, Combifix e Duofix dotate del corpo cassetta UP320 o simili

Plate for Geberit Waste System featuring with Unica+, Combifix e Duofix that mounted body UP320 or similar

Drückerplatte für Geberit Installationssysteme (Unica+, Combifix und Duofix), die mit UP320 Kassettengehäuse oder ähnlichem ausgestattet sind.

Клавиша смыва для бачков скрытого монтажа Geberit с Unica+, Combifix e Duofix установленных в бачки UP320 или подобные

cm 33LxP2,5xH17

• 16 - oro / gold / or / gold / Золото



1098

Placca comando per cassetta incasso mod. Geberit, compatibile con Unica+, Combifix e Duofix dotate del corpo cassetta UP320 o simili

Plate for Geberit Waste System featuring with Unica+, Combifix e Duofix that mounted body UP320 or similar

Drückerplatte für Geberit Installationssysteme (Unica+, Combifix und Duofix), die mit UP320 Kassettengehäuse oder ähnlichem ausgestattet sind.

Клавиша смыва для бачков скрытого монтажа Geberit с Unica+, Combifix e Duofix установленных в бачки UP320 или подобные

cm 33LxP2,5xH17

• 25 - bronzo / bronze / bronze / bronze / Бронза



1098

Placca comando per cassetta incasso mod. Geberit, compatibile con Unica+, Combifix e Duofix dotate del corpo cassetta UP320 o simili

Plate for Geberit Waste System featuring with Unica+, Combifix e Duofix that mounted body UP320 or similar

Drückerplatte für Geberit Installationssysteme (Unica+, Combifix und Duofix), die mit UP320 Kassettengehäuse oder ähnlichem ausgestattet sind.

Клавиша смыва для бачков скрытого монтажа Geberit с Unica+, Combifix e Duofix установленных в бачки UP320 или подобные

cm 33LxP2,5xH17

• 12 - nichel lucido polish nikel / nikel poli / nikel poliert / Глянцевый никель



PIANTANE E COLONNE ATTREZZATE

_FUNZIONI DECISE
PER ESIGENZE INFINITE

Designer: Stilhaus, Gianluca Paludi
Fuori misura: Sì

Designer: Stilhaus, Gianluca Paludi
Customized: Yes

Designer: Stilhaus, Gianluca Paludi
Personnalis : Oui

Designer: Stilhaus, Gianluca Paludi
Kundenspezifische: Ja

Разработка дизайна: Stilhaus , Gianluca Paludi
Негабаритный: да





EQUILIBRIUM MARMO _ BRASS AND MARBLE

realizzata in ottone / realized in brass / réalisée en laiton / aus Messing hergestellt / Сделано из латуни

Designer Gianluca Paludi



1239

Piantana: porta rotolo e scopino
Free-standing upright: paper holder and toilet-brush holder
Montant autonome: porte rouleau et porte balayent
Ständer: Papierrollenhalter und Bürstengarnitur
Стойка: бумагодержатель+ерш металлический
cm Ø 12 x 14,5 L x 56 H

• 08 - 23

• 10 - 18 - 36 - 56

• 17

1240

Piantana: porta rotolo
Free-standing upright: paper holder
Support : porte-rouleau
Ständer: Rollenhalter
Подставка: держатель рулона
cm Ø 12 x 14,5 L x 56 H

• 08 - 23

• 10 - 18 - 36 - 56

• 17

1241

Piantana: porta rotolo, porta salviette e scopino
Free-standing upright: paper holder, towel rail and toilet-brush holder
Unité autonome : porte-rouleau de papier toilette, porte-serviette et brosse de toilette
Freistehende Einheit: Toilettenpapierhalter, Handtuchhalter und Toilettenbürste
Отдельно стоящее устройство: держатель рулона туалетной бумаги, полотенцедержатель и туалетный ершик
cm Ø 12 x 36 L x 80 H

• 08 - 23

• 10 - 18 - 36 - 56

• 17

1242

Piantana: porta rotolo e porta salviette
Free-standing upright: paper holder and Towel rail
Sur pied : porte-rouleau de papier toilette et porte-serviette
Stehleuchte: Toilettenpapier- und Handtuchhalter
Напольный светильник: держатель для туалетного рулона и полотенца
cm Ø 12 x 36 L x 80 H

• 08 - 23

• 10 - 18 - 36 - 56

• 17

1243

Piantana: scopino, dosatore sapone, porta asciugamani e porta rotolo
Free-standing upright: toilet brush holder, soap dispenser, towel holder and paper holder
Montant autonome: porte balayent, doseur de savon, porte serviette et porte rouleau
Ständer: Bürstengarnitur, Flüssigseifenspender, Handtuchhalter und Papierrollenhalter
Стойка: мывница + полотенцедержатель + бумагодержатель + ёрш металлический
cm Ø 12 x 36 L x 84 H

• 08 - 23

• 10 - 18 - 36 - 56

• 17

1244

Piantana porta asciugamani
Free-standing upright towel rail
Porte-serviettes
Handtuchhalter
Подставка для полотенца
cm Ø 12 x 45 L x 80 H

• 08 - 23

• 10 - 18 - 36 - 56

• 17

** FINITURA DISPONIBILE IN 20 GG.
Finish available in 20 days
Finition disponible en 20 jours
Oberfläche lieferbar in 20 Tagen
Отделка доступна в течение 20 дней



08

10

17



18

23

36

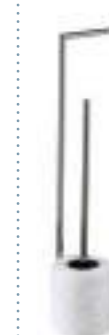

56

EQUILIBRIUM RESINA _ BRASS AND RESIN

realizzata in ottone / realized in brass / réalisée en laiton / aus Messing hergestellt / Сделано из латуни

Designer Gianluca Paludi



1302

Piantana: porta rotolo e scopino
 Freestanding unit: toilet roll holder and toilet brush
 Lampadaire : porte-rouleau de papier toilette et brosse de toilette
 Stehleuchte: Toilettenpapierhalter und Toilettenbürste
 Напольный светильник: держатель для туалетного рулона и щетка для унитаза
 cm Ø 12 x 14,5 L x 56 H

• 08 - 23

• 10 - 18 - 36 - 56

• 17

1303

Piantana: porta rotolo
 Free-standing upright: paper holder
 Support : porte-rouleau
 Ständer: Rollenhalter
 Подставка: держатель рулона
 cm Ø 12 x 14,5 L x 56 H

• 08 - 23

• 10 - 18 - 36 - 56

• 17

1304

Piantana: porta rotolo, porta salviette e scopino.
 Free-standing upright: paper holder, towel rail and toilet-brush holder.
 Unité autonome : porte-rouleau de papier toilette, porte-serviette et brosse de toilette
 Handtuchleiter
 полотенцедержатель напольный
 cm Ø 12 x 36 L x 80 H

• 08 - 23

• 10 - 18 - 36 - 56

• 17

1305

Piantana: porta rotolo e porta salviette
 Free-standing upright: paper holder and Towel rail
 Sur pied : porte-rouleau de papier toilette et porte-serviette
 Stehleuchte: Toilettenpapier- und Handtuchhalter
 Напольный светильник: держатель для туалетного рулона и полотенца
 cm Ø 12 x 36 L x 80 H

• 08 - 23

• 10 - 18 - 36 - 56

• 17

1306

Piantana: scopino, dosatore sapone, porta asciugamani e porta rotolo
 Free-standing upright: toilet brush holder, soap dispenser, towel holder and paper holder
 Montant autonome: porte balayent, doseur de savon, porte serviette et porte rouleau
 Ständer: Bürstengarnitur, Flüssigseifenspender, Handtuchhalter und Papierrollenhalter
 Стойка: мыльница + полотенцедержатель + бумагодержатель + ёрш металлический
 cm Ø 12 x 36 L x 84 H

• 08 - 23

• 10 - 18 - 36 - 56

• 17

€ 430,00

€ 520,00

€ 590,00

1307

Piantana porta asciugamani
 Free-standing upright towel rail
 Porte-serviettes
 Handtuchhalter
 Подставка для полотенца
 cm Ø 12 x 45 L x 80 H

• 08 - 23

• 10 - 18 - 36 - 56

• 17

** FINITURA DISPONIBILE IN 20 GG.
 Finish available in 20 days
 Finition disponible en 20 jours
 Oberfläche lieferbar in 20 Tagen
 Отделка доступна в течение 20 дней



08

10

17



18

23

36



56

NEOP

NERO OPACO
 Matt black
 Noir mat
 Mattschwarz
 матовый черный



Disponibili in neolite opaco (maggiorazione)
 Available in matt neolite (supplement)
 Disponible en néolite mat (supplément)
 Erhältlich in mattem Neolith (Zuschlag)
 Доступен в матовом неолитовом цвете (дополнительно)

€ 25,00

EQUILIBRIUM OTTONE _ TOTAL BRASS

realizzata in ottone / realized in brass / réalisée en laiton / aus Messing hergestellt / Сделано из латуни

Designer Gianluca Paludi



1246

Piantana: porta rotolo e scopino
Free-standing upright: paper holder and toilet-brush holder
Montant autonome: porte rouleau et porte balayent
Ständer: Papierrollenhalter und Bürstengarnitur
Стойка: бумагодержатель+ерш металлический
cm Ø 13 x 14,5 L x 56 H

• 08 - 23
• 10 - 18 - 36 - 56
• 17

1247

Piantana: porta rotolo
Stand: roll holder
Support : porte-rouleau
Ständer: Rollenhalter
Подставка: держатель рулона
cm Ø 13 x 14,5 L x 56 H

• 08 - 23
• 10 - 18 - 36 - 56
• 17

1248

Piantana: porta rotolo, porta salviette e scopino.
Free-standing upright: paper holder, towel rail and toilet-brush holder.
Unité autonome : porte-rouleau de papier toilette, porte-serviette et brosse de toilette
Handtuchleiter
полотенцедержатель напольный
cm Ø 17 x 36 L x 78 H

• 08 - 23
• 10 - 18 - 36 - 56
• 17

1249

Piantana: porta rotolo e porta salviette
Free-standing upright: paper holder and Towel rail
Sur pied : porte-rouleau de papier toilette et porte-serviette
Stehleuchte: Toilettenpapier- und Handtuchhalter
Напольный светильник: держатель для туалетного рулона и полотенца
cm Ø 17 x 36 L x 79 H

• 08 - 23
• 10 - 18 - 36 - 56
• 17

1250

Piantana: scopino ottone, dosatore sapone, porta asciugamani e porta rotolo
Free-standing upright: toilet brush holder, soap dispenser, towel holder and paper holder
Montant autonome: porte balayent, porte savon liqid, porte serviette et porte rouleau
Ständer: Bürstengarnitur, Seifenschale, Handtuchhalter und Papierrollenhalter
Стойка: мыльница + полотенцедержатель + бумагодержатель + ерш металлический
cm Ø 17 x 36 L x 84 H

• 08 - 23
• 10 - 18 - 36 - 56
• 17

1251

Piantana porta asciugamani
Towel stand
Porte-serviettes
Handtuchhalter
Подставка для полотенца
cm Ø 22 x 45 L x 79 H

• 08 - 23
• 10 - 18 - 36 - 56
• 17

** FINITURA DISPONIBILE IN 20 GG.
Finish available in 20 days
Finition disponible en 20 jours
Oberfläche lieferbar in 20 Tagen
Отделка доступна в течение 20 дней



08 10 17



18 23 36



56

HASHI

realizzata in ottone / realized in brass / réalisée en laiton / aus Messing hergestellt / Сделано из латуни



972

972

Piantana: porta rotolo e scopino ceramica
Free-standing upright: paper holder and toilet-brush holder
Montant autonome: porte rouleau et porte balayent
Ständer: Papierrollenhalter und Bürstengarnitur
Стойка: бумагодержатель + ерш металлический керамика
base cm Ø 13 x 62 H

• 08 - 23 - 24

• 18 - 56

• 17



971

971

Piantana: scopino ottone, porta sapone, porta asciugamani e porta rotolo
Free-standing upright: toilet brush holder, soap dish, towel holder and paper holder
Montant autonome: porte balayent, porte savon, porte serviette et porte rouleau
Ständer: Bürstengarnitur, Seifenschale, Handtuchhalter und Papierrollenhalter
Стойка: мыльница + полотенцедержатель + бумагодержатель + ерш металлический
base cm Ø 13 x 73 H

• 08 - 23 - 24

• 18 - 56

• 17

* Condosatore sapone liquido (maggiorazione)
With liquid soap dispenser (supplement)
Avec doseur de savon liquide (supplément)
Mit Seifenspender (Zuschlag)
с дозатором (дополнительно)



969

969

Piantana: porta rotolo e scopino ottone
Free-standing upright: paper holder toilet-brush
Montant autonome: porte rouleau et porte balayent
Ständer: Papierrollenhalter und Bürstengarnitur
Стойка: бумагодержатель + ерш металлический
base cm Ø 13 x 63 H

• 08 - 23 - 24

• 18 - 56

• 17



1123

1123

Piantana con 2 portasciugamani
Free-standing upright with 2 towel holders
Montant autonome avec 2 porte serviette
Handtuchständer 2 armig
Стойка для 2-ух полотенец
cm 81,5 H - 29 L • Base Ø 22

• 08 - 23 - 24

• 18 - 56

• 17



1123/3

1123/3

Piantana con 3 portasciugamani
Free-standing upright with 3 towel holders
Montant autonome avec 3 porte serviette
Handtuchständer 3 armig
Стойка для 3-ух полотенец
cm 85,5 H - 29 L • Base Ø 22

• 08 - 23 - 24

• 18 - 56

• 17

€ 225,00

€ 290,00

€ 330,00



1189

1189

Scaletta portasalviette
Ladder towel holder
Escalier porte serviettes
Handtuchleiter
полотенцедержатель напольный
cm 40 L x 142 H

• 08 - 23 - 24

• 18 - 56

• 17



23

** FINITURA DISPONIBILE IN 20 GG.
Finish available in 20 days
Finition disponible en 20 jours
Oberfläche lieferbar in 20 Tagen
Отделка доступна в течение 20 дней



17**

18**

23



24

56**



MEDEA

realizzata in ottone / realized in brass / réalisée en laiton / aus Messing hergestellt / Сделано из латуни



ME 972

ME 972

Piantana: porta rotolo e scopino ceramica
Free-standing upright: paper holder and toilet-brush holder
Montant autonome: porte rouleau et porte balayent en ceramique
Ständer: Papierrollenhalter und Bürstengarnitur aus Keramik
Стойка: бумагодержатель+ерш керамический
base cm Ø 13 x 64 H

• 08 - 23
• 16 - 18 - 36



ME 20

ME 20

Piantana: porta rotolo e scopino
Free-standing upright: paper holder and toilet-brush holder
Montant autonome: porte rouleau et porte balayent
Ständer: Papierrollenhalter und Bürstengarnitur
Стойка: бумагодержатель+ерш металлический
base cm Ø 13 x 62 H

• 08 - 23
• 16 - 18 - 36



ME 21

ME 21

Piantana: scopino, porta sapone, porta asciugamani e porta rotolo
Free-standing upright: toilet brush holder, soap dish, towel holder and paper holder
Montant autonome: porte balayent, porte savon, porte serviette et porte rouleau
Ständer: Bürstengarnitur, Seifenschale, Handtuchhalter und Papierrollenhalter
Стойка: ёрш металлический+ мьльница+бумагодержатель+ полотенцедержатель
base cm Ø 17 x 88 H

• 08 - 23
• 16 - 18 - 36

* Condosatore sapone liquido (maggiorazione)
With liquid soap dispenser (supplement)
Avec doseur de savon liquide (supplément)
Mit Seifenspender (Zuschlag)
с дозатором (дополнительно)



ME 19

ME 19

Piantana con 2 portasciugamani
Free-standing upright with 2 towel holders
Montant autonome avec 2 porte serviette
Handtuchständer 2 armig
Стойка для 2-ух полотенец
base cm Ø 22 / 81 H - 28/30 L

• 08 - 23
• 16 - 18 - 36



1158

1158

Cavalletto portasciugamani
Free-standing towel holders
Montant autonome porte serviette
Handtuchständer
полотенцедержатель напольный
cm 60 L x 20 P x 91 H

• 08 - 23
• 16 - 18 - 36

** FINITURA DISPONIBILE IN 20 GG.
Finish available in 20 days
Finition disponible en 20 jours
Oberfläche lieferbar in 20 Tagen
Отделка доступна в течение 20 дней



16**

18**



23

36**



*

URANIA

realizzata in ottone / realized in brass / réalisée en laiton / aus Messing hergestellt / Сделано из латуни



U 20

U 20

Piantana: porta rotolo e scopino ceramica
Free-standing upright: paper holder
and toilet-brush holder
Montant autonome: porte rouleau et
porte balayent en ceramique
Ständer: Papierrollenhalter und
Bürstengarnitur aus Keramik
Стойка: бумагодержатель + ёрш керамический
base cm 16 L x 13 P x 66 H

• 08 - 23

• 36



U 20 M

U 20 M

Piantana: porta rotolo e scopino ottone
Free-standing upright: paper holder
and toilet-brush holder brass
Montant autonome: porte rouleau et porte
balayent en laiton
Ständer: Papierrollenhalter und
Bürstengarnitur aus Messing
Стойка: ёрш металлический +
бумагодержатель
base cm 13 L x 16 P x 66 H

• 08 - 23

• 36



U 21

U 21

Piantana: scopino ceramica, p. sapone,
p. asciugamani e p. rotolo
Free-standing upright: toilet brush holder,
soap dish, towel holder and paper holder
Montant autonome: porte balayent,
porte savon, porte serviette et porte rouleau
Ständer: Bürstengarnitur, Seifenschale,
Handtuchhalter und Papierrollenhalter
Стойка: ёрш керамический +
мыльница + бумагодержатель +
полотенцедержатель
base cm 16 L x 13 P x 76 H

• 08 - 23

• 36

* Condosatore sapone liquido (maggiorazione)
With liquid soap dispenser (supplement)
Avec doseur de savon liquide (supplément)
Mit Seifenspender (Zuschlag)
с дозатором (дополнительно)



U 21 M

U 21 M

Piantana: scopino ottone, p. sapone,
p. asciugamani e p. rotolo
Free-standing upright: toilet brush holder,
soap dish, towel holder and paper holder
Montant autonome: porte balayent,
porte savon, porte serviette et porte rouleau
Ständer: Bürstengarnitur, Seifenschale,
Handtuchhalter und Papierrollenhalter
Стойка: ёрш металлический +
мыльница + бумагодержатель +
полотенцедержатель
base cm 16 L x 13 P x 76 H

• 08 - 23

• 36

* Condosatore sapone liquido (maggiorazione)
With liquid soap dispenser (supplement)
Avec doseur de savon liquide (supplément)
Mit Seifenspender (Zuschlag)
с дозатором (дополнительно)



U 19

U 19

Piantana con 2 portasciugamani
Free-standing upright with 2 towel holders
Montant autonome avec 2 porte serviette
Handtuchständer 2 armig
Стойка для 2-ух полотенец
base cm 20 L x 15 P x 81,5 H - 30/28 L

• 08 - 23

• 36

€ 290,00

€ 370,00



780

780 URANIA

Scaletta portaserviette
Ladder towel holder
Escalier porte serviettes
Handtuchleiter
полотенцедержатель напольный
cm 42 L x 142 H x 7,5/15 P

• 08 - 23

• 36

** FINITURA DISPONIBILE IN 20 GG.
Finish available in 20 days
Finition disponible en 20 jours
Oberfläche lieferbar in 20 Tagen
Отделка доступна в течение 20 дней



23



36**



*

DIANA

realizzata in ottone / realized in brass / réalisée en laiton / aus Messing hergestellt / Сделано из латуни



DI 20

DI 20

Piantana: porta rotolo e scopino
Free-standing upright: paper holder
and toilet-brush holder
Montant autonome: porte rouleau et
porte balayent
Ständer: Papierrollenhalter und
Bürstengarnitur
Стойка: бумагодержатель+ёрш
металлический
base cm 16 L x 13 P x 62 H

- 08



DI 21

DI 21

Piantana: scopino, porta sapone,
porta asciugamani e porta rotolo
Free-standing upright: toilet brush holder,
soap dish, towel holder and paper holder
Montant autonome: porte balayent,
porte savon, porte serviette et porte rouleau
Ständer: Bürstengarnitur, Seifenschale,
Handtuchhalter und Papierrollenhalter
Стойка: ёрш металлический+
мыльница+бумагодержатель+
полотенцедержатель
base cm 14 L x 16 P x 77 H

- 08

* Condosatore sapone liquido (maggiorazione)
With liquid soap dispenser (supplement)
Avec doseur de savon liquide (supplément)
Mit Seifenspender (Zuschlag)
с дозатором (дополнительно)



DI 19

DI 19

Piantana con 2 portasciugamani
Free-standing upright with 2 towel holders
Montant autonome avec 2 porte serviette
Handtuchständer 2 armig
Стойка для 2-ух полотенец
base cm 20 L x 15 P x 83 H - 28/30 L

- 08



LV 20

LV 20

Piantana: porta rotolo e scopino
Free-standing upright: paper holder
and toilet-brush holder
Montant autonome: porte rouleau et
porte balayent
Ständer: Papierrollenhalter und
Bürstengarnitur
Стойка: бумагодержатель+ёрш
металлический
base cm Ø 13 x 72,5 H

- 08 - 05 - 03



LV 21

LV 21

Piantana: scopino, porta sapone,
porta asciugamani e porta rotolo
Free-standing upright: toilet brush holder,
soap dish, towel holder and paper holder
Montant autonome: porte balayent,
porte savon, porte serviette et porte rouleau
Ständer: Bürstengarnitur, Seifenschale,
Handtuchhalter und Papierrollenhalter
Стойка: ёрш металлический+
мыльница+бумагодержатель+
полотенцедержатель
base cm Ø 17 x 87 H

- 08 - 05 - 03

* Condosatore sapone liquido (maggiorazione)
With liquid soap dispenser (supplement)
Avec doseur de savon liquide (supplément)
Mit Seifenspender (Zuschlag)
с дозатором (дополнительно)



LV 19

LV 19

Piantana con 2 portasciugamani
Free-standing upright with 2 towel holders
Montant autonome avec 2 porte serviette
Handtuchständer 2 armig
Стойка для 2-ух полотенец
base cm Ø 22 x 78,5 H - 28/30 L

- 08 - 05 - 03



03

05



*

* FINITURA DISPONIBILE IN 20 GG.
Finish available in 20 days
Finition disponible en 20 jours
Oberfläche lieferbar in 20 Tagen
Отделка доступна в течение 20 дней

LIVING

realizzata in ottone / realized in brass / réalisée en laiton / aus Messing hergestellt / Сделано из латуни

LIZ

realizzata in ottone / realized in brass / réalisée en laiton / aus Messing hergestellt / Сделано из латуни



856

856

Piantana: porta rotolo e scopino
Free-standing upright: paper holder
and toilet-brush holder
Montant autonome: porte rouleau et porte balayent
Ständer: Papierrollenhalter und Bürstengarnitur
Стойка: 3 крючка под халаты и 3
полотенцедержателя
base cm Ø 17 x 62 H

- 08



857

857

Piantana: scopino, porta sapone, porta asciugamani e porta rotolo
Free-standing upright: toilet brush holder, soap dish, towel holder and paper holder
Montant autonome: porte balayent, porte savon, porte serviette et porte rouleau
Ständer: Bürstengarnitur, Seifenschale, Handtuchhalter und Papierrollenhalter
Стойка: ёрш металлический+ мыльница+бумагодержатель+полотенцедержатель
base cm Ø 17 x 72 H

- 08

* Condosatore sapone liquido (maggiorazione)
With liquid soap dispenser (supplement)
Avec doseur de savon liquide (supplément)
Mit Seifenspender (Zuschlag)
с дозатором (дополнительно)



855

855

Piantana con 2 portasciugamani
Free-standing upright with 2 towel holders
Montant autonome avec 2 porte serviette
Handtuchständer 2 armig
Стойка для 2-ух полотенец
base cm Ø 22 x 88 H - 34 L

- 08



858

858

Piantana porta accappatoio con portasciugamani
Free-standing upright bathrobe with towel holders
Montant autonome peignoir avec porte serviette
Bademantelständer armig
Стойка: крючка под халаты и 3 полотенецдержателя
base cm Ø 22 x 176 H - 34 L

- 08



Q 20

Q 20

Piantana: porta rotolo e scopino
Free-standing upright: paper holder
and toilet-brush holder
Montant autonome: porte rouleau et porte balayent
Ständer: Papierrollenhalter und Bürstengarnitur
Стойка: бумагодержатель + ёрш металлический
base cm 16 L x 17 P x 68,5 H

- 08



Q 21

Q 21

Piantana: scopino, porta sapone, porta asciugamani e porta rotolo
Free-standing upright: toilet brush holder, soap dish, towel holder and paper holder
Montant autonome: porte balayent, porte savon, porte serviette et porte rouleau
Ständer: Bürstengarnitur, Seifenschale, Handtuchhalter und Papierrollenhalter
Стойка: ёрш металлический + мыльница + бумагодержатель + полотенецдержатель
base cm 16 L x 14 P x 93,5 H

- 08

* Condosatore sapone liquido (maggiorazione)
With liquid soap dispenser (supplement)
Avec doseur de savon liquide (supplément)
Mit Seifenspender (Zuschlag)
с дозатором (дополнительно)



Q 19

Q 19

Piantana con 3 portasciugamani
Free-standing upright with 3 towel holders
Montant autonome avec 3 porte serviette
Handtuchständer 3 armig
Стойка: 3 полотенецдержателя
base cm 20 L x 15 P x 86 H - 30,5 L

- 08

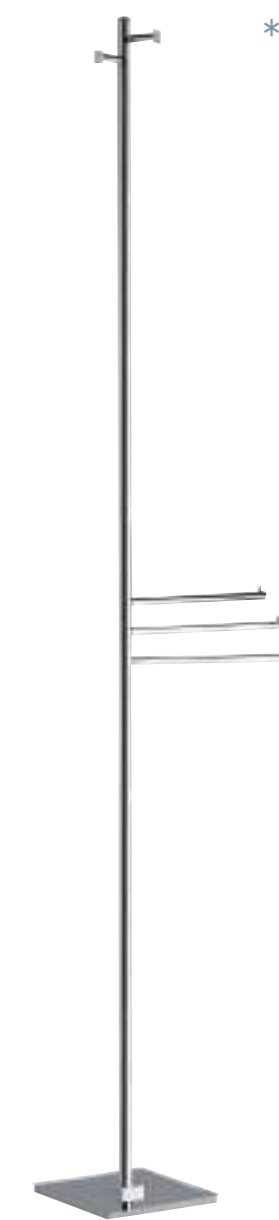

Q 817

Q 817

Piantana porta accappatoio con 3 portasciugamani
Free-standing upright bathrobe with 3 towel holders
Montant autonome peignoir avec 3 porte serviette
Bademantelständer 3 armig
Стойка для халата и под 3 полотенца
base cm 22 L x 22 P x 173,5 H - 30 L

- 08



design Claudio Papa QUID

realizzata in ottone / realized in brass / réalisée en laiton / aus Messing hergestellt / Сделано из латуни

realizzata in ottone / realized in brass / réalisée en laiton / aus Messing hergestellt / Сделано из латуни



EL 20



EL 21



EL 19

EL 20

Piantana: porta rotolo e scopino
Free-standing upright: paper holder
and toilet-brush holder

Montant autonome: porte rouleau et porte balayent
Ständer: Papierrollenhalter und Bürstengarnitur
Стойка: бумагодержатель +
ерш металлический
base cm Ø 20 x 67 H

• 08
• 02
• 16 - 25 - 36

EL 21

Piantana: scopino, porta sapone,
porta asciugamani e porta rotolo
Free-standing upright: toilet brush holder,
soap dish, towel holder and paper holder
Montant autonome: porte balayent, porte
savon, porte serviette et porte rouleau
Ständer: Bürstengarnitur, Seifenschale,
Handtuchhalter und Papierrollenhalter
Стойка: ёрш металлический +
мыльница + бумагодержатель +
полотенцедержатель
base cm Ø 20 x 85,5 H

• 08
• 02
• 16 - 25 - 36

* Condosatore sapone liquido (maggiorazione)
With liquid soap dispenser (supplement)
Avec doseur de savon liquide (supplément)
Mit Seifenspender (Zuschlag)
с дозатором (дополнительно)

EL 19

Piantana con 3 portasciugamani
Free-standing upright with 3 towel holders
Montant autonome avec 3 porte serviette
Handtuchständer 3 armig
Стойка: 3 полотенецедержателя
base cm Ø 25 x 91 H - 30/27/24 L

• 08
• 02
• 16 - 25 - 36

realizzata in ottone / realized in brass / réalisée en laiton / aus Messing hergestellt / Сделано из латуни



746

746 NESTOR

Portasciugamani
Free-standing towel holder
Montant autonome porte serviette
Handtuchständer
полотенецедержатель напольный
cm 58 L x 35 P x 80 H

• 08
• 16 - 25 - 36

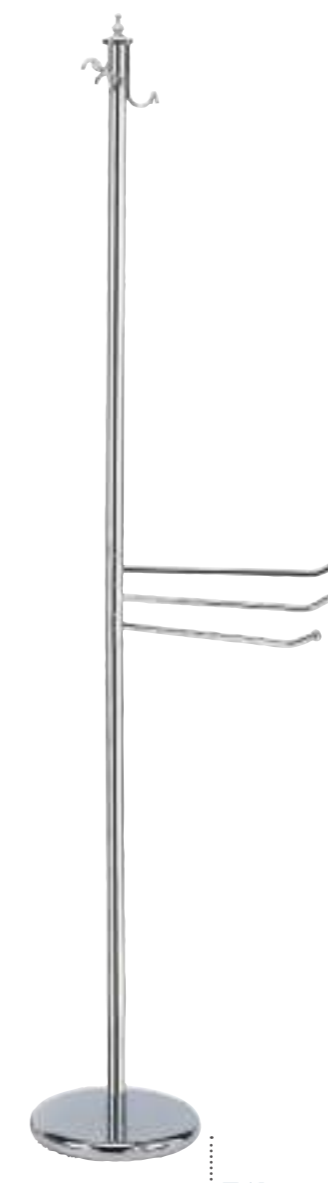

741

741 MIRTA

Piantana porta accappatoio
con 3 portasciugamani
Free-standing upright bathrobe with 3 towel holders
Montant autonome peignoir avec 3 porte serviette
Bademantelständer 3 armig
Стойка: 3 крючка под халаты и 3
полотенецедержателя
base cm Ø 25 x 168 H - 32 L

• 08
• 02
• 16 - 25 - 36

** FINITURA DISPONIBILE IN 20 GG.
Finish available in 20 days
Finition disponible en 20 jours
Oberfläche lieferbar in 20 Tagen
Отделка доступна в течение 20 дней



02

16**



25

36**



IDRA

realizzata in ottone / realized in brass / réalisée en laiton / aus Messing hergestellt / Сделано из латуни



i 20

i 21

i 19

i 20

Piantana: porta rotolo e scopino
Free-standing upright: paper holder
and toilet-brush holder
Montant autonome: porte rouleau et porte
balayent
Ständer: Papierrollenhalter und Bürstengarnitur
Стойка: бумагодержатель +
ерш керамический
base cm Ø 20 x 74 H

• 08 - 12
• 25 - 26

i 21

Piantana: scopino, porta sapone, porta
asciugamani e porta rotolo
Free-standing upright: toilet brush holder,
soap dish, towel holder and paper holder
Montant autonome: porte balayent,
porte savon, porte serviette et porte rouleau
Ständer: Bürstengarnitur, Seifenschale,
Handtuchhalter und Papierrollenhalter
Стойка: ёрш керамический +
мыльница + бумагодержатель +
полотенцедержатель
base cm Ø 20 x 84 H

• 08 - 12
• 25 - 26

i 19

Piantana con 2 portasciugamani
Free-standing upright with 2 towel holders
Montant autonome avec 2 porte serviette
Handtuchständer 2 armig
Стойка для полотенец
base cm Ø 25 x 91 H - 30/24 L

• 08 - 12
• 25 - 26

NEMI

realizzata in ottone / realized in brass / réalisée en laiton / aus Messing hergestellt / Сделано из латуни



N 20

N 21

N 19

N 23

N 20

Piantana: porta rotolo e scopino
Free-standing upright: paper holder
and toilet-brush holder
Montant autonome: porte rouleau et porte
balayent
Ständer: Papierrollenhalter und Bürstengarnitur
Стойка: бумагодержатель +
ерш металлический
base cm Ø 20 x 69 H

• 33 - 39
• 40

N 21

Piantana: scopino, porta sapone, porta
asciugamani e porta rotolo
Free-standing upright: toilet brush holder,
soap dish, towel holder and paper holder
Montant autonome: porte balayent,
porte savon, porte serviette et porte rouleau
Ständer: Bürstengarnitur, Seifenschale,
Handtuchhalter und Papierrollenhalter
Стойка: ёрш металлический +
мыльница + бумагодержатель +
полотенцедержатель
base cm Ø 20 x 79 H

• 33 - 39
• 40

N 19

Piantana con 3 portasciugamani
Free-standing upright with 3 towel holders
Montant autonome avec 3 porte serviette
Handtuchständer 3 armig
Стойка: 3 полотенецдержателя
base cm Ø 25 x 91 H - 32 L

• 33 - 39
• 40

N 23

Piantana porta accappatoio
con 3 portasciugamani
Free-standing upright bathrobe with 3 towel holders
Montant autonome peignoir avec 3 porte serviette
Bademantelständer 3 armig
Стойка: 3 крючка под халаты и 3
полотенецдержателя
base cm Ø 25 x 169 H

• 33 - 39
• 40



N 33

N 40

PIANTANE

** FINITURA DISPONIBILE IN 20 GG.
 ** Finish available in 20 days
 Finition disponible en 20 jours
 Oberfläche lieferbar in 20 Tagen
 Отделка доступна в течение 20 дней



02

16**



25

GIUNONE

realizzata in ottone / realized in brass / réalisée en laiton / aus Messing hergestellt/Сделано из латуни



G 691

G 697

G 696

G 691

Piantana: porta rotolo e scopino
 Free-standing upright: paper holder
 and toilet-brush holder
 Montant autonome: porte rouleau et porte balayent
 Ständer: Papierrollenhalter und Bürstengarnitur
 Стойка: бумагодержатель + ерш металлический
 base cm Ø 20 x 67 H

- 08

- 02 - 03 - 04

- 16 - 25 - 26 - 36

G 697

Piantana: scopino, porta sapone,
 porta asciugamani e porta rotolo
 Free-standing upright: toilet brush, soap dish,
 towel holder and paper holder
 Montant autonome: balayent, porte savon,
 porte serviette et porte rouleau
 Ständer: Bürstengarnitur, Seifenschale,
 Handtuchhalter und Papierrollenhalter
 Стойка: ёрш металлический +
 мыльница + бумагодержатель +
 полотенцедержатель
 base cm Ø 20 x 85 H

- 08

- 02 - 03 - 04

- 16 - 25 - 26 - 36

G 696

Piantana con 3 portasciugamani
 Free-standing upright with 3 towel holders
 Montant autonome avec 3 porte serviette
 Handtuchständer 3 armig
 Стойка для 3-х полотенец
 base cm Ø 25 x 98 H - 25/28/31 L

- 08

- 02 - 03 - 04

- 16 - 25 - 26 - 36

PRISMA

realizzata in ottone / realized in brass / réalisée en laiton / aus Messing hergestellt/Сделано из латуни

** FINITURA DISPONIBILE IN 20 GG.
 ** Finish available in 20 days
 Finition disponible en 20 jours
 Oberfläche lieferbar in 20 Tagen
 Отделка доступна в течение 20 дней



16**

25**



PR 20

PR 21

PR 19

PR 20

Piantana: porta rotolo e scopino
 Free-standing upright: paper holder
 and toilet-brush holder
 Montant autonome: porte rouleau et porte balayent
 Ständer: Papierrollenhalter und Bürstengarnitur
 Стойка: бумагодержатель +
 ерш металлический
 base cm Ø 20 x 73 H

- 08

- 16 - 25

PR 21

Piantana: scopino, porta sapone,
 porta asciugamani e porta rotolo
 Free-standing upright: toilet brush holder,
 soap dish, towel holder and paper holder
 Montant autonome: porte balayent, porte
 savon, porte serviette et porte rouleau
 Ständer: Bürstengarnitur, Seifenschale,
 Handtuchhalter und Papierrollenhalter
 Стойка: ёрш металлический +
 мыльница + бумагодержатель +
 полотенцедержатель
 base cm Ø 20 x 90 H

- 08

- 16 - 25

Condosatore sapone liquido (maggiorazione)
 With liquid soap dispenser (supplement)
 Avec doseur de savon liquide (supplément)
 Mit Seifenspender (Zuschlag)
 с дозатором (дополнительно)

PR 19

Piantana con 3 portasciugamani
 Free-standing upright with 3 towel holders
 Montant autonome avec 3 porte serviette
 Handtuchständer 3 armig
 Стойка: 3 полотенцедержателя
 base cm Ø 25 x 93 H - 30/27/24 L

- 08

- 16 - 25



URANIA

realizzata in ottone / realized in brass / réalisée en laiton / aus Messing hergestellt / Сделано из латуни



U 24

U 24 URANIA

Colonna componibile a parete per lavabo
 Wall mounted modular column for washbasin
 Colonne à éléments à mur pour lavabo
 Stangensystem für Waschtisch-Set
 Настенная модульная колонна в комплектации для раковины

U 24 ASTA H CM 90
 Barcm90H/BarreHcm90/StangeHcm90

U 24.561 SPECCHIO INGRANDITORE CM. 12
 Enlargingmirror/Miroiragrandisseur/
 Vergrößerungsspiegel

U 24.05 ASTA PORTASCIUGAMANI CM 35 L
 Towelholder/Porteserviette/Handtuchhalter

U 24.09 PORTA SAPONE
 Soapdish/Portesavon/Seifenschale

U 24.10 PORTA BICCHIERE
 Glassholder/Porteverre/Zahnbürstenhalter

COMPOSIZIONE COME FOTO
 Composition as photo
 Composition comme photo
 Kombination wie auf dem Bild
 Композиция как фото



U 25

U 25 URANIA

Colonna componibile a parete per wc/bidet
 Wall mounted modular column for wc/bidet
 Colonne à éléments à mur pour wc/bidet
 Stangensystem für WC/Bidet-Set
 Настенная модульная колонна в комплектации для унитаза/биде

U 25 ASTA H CM 70
 Barcm70H/BarreHcm70/StangeHcm70

U 25.06 ASTA PORTASCIUGAMANI CM 25 L
 Towelholder/Porteserviette/Handtuchhalter

U 25.30 DOSATORE SAPONE LIQUIDO
 Dispensing soap/Dosateurliquide/Sapenger

U 25.11 PORTA ROTOLO
 Paperholder/Porterouleau/Papierrollenhalter

U 25.039Q PORTA SCOPINO QUADRO
 Squaretoiletbrush/Portebalayentcadre/
 Quadratische Bürstengarnitur

COMPOSIZIONE COME FOTO CM 75
 Composition as photo
 Composition comme photo
 Kombination wie auf dem Bild
 Композиция как фото



U 26

U 26

Colonna componibile a parete porta salviette
 Modular wall-mounted towel rail column
 Colonne porte-serviettes murale modulaire
 Modulare wandmontierte Handtuchhalter-Säule
 Модульная настенная колонна для полотенцесушителя
 cm 35L x 40H

- 08



ME 24

ME 24

Colonna componibile a parete per lavabo
 Wall mounted modular column for washbasin
 Colonne à éléments à mur pour lavabo
 Stangensystem für Waschtisch-Set
 Настенная модульная колонна в комплектации для раковины

ME 24 ASTA H CM 80
 Barcm80H/BarreHcm80/StangeHcm80

ME 24.05 ASTA PORTASCIUGAMANI CM 35 L
 Towelholder/Porteserviette/Handtuchhalter

ME 24.09V PORTA SAPONE IN VETRO
 Glasssoapdish/Portesavonverre/
 Seifenschale aus Glas

ME 24.10V PORTA BICCHIERE IN VETRO
 Glassholder/Porteverre/Zahnbürstenhalter

ME 24.10M PORTA BICCHIERE IN METALLO
 Metalglassholder/Porteverreenmetal/
 Zahnbürstenhalter aus Metall

ME 24.562 SPECCHIO INGRANDITORE
 Enlargingmirror/Miroiragrandisseur/
 Vergrößerungsspiegel

COMPOSIZIONE COME FOTO
 Composition as photo
 Composition comme photo
 Kombination wie auf dem Bild
 Композиция как фото



ME 25

ME 25

Colonna componibile a parete per wc/bidet
 Wall mounted modular column for wc/bidet
 Colonne à éléments à mur pour wc/bidet
 Stangensystem für WC/Bidet-Set
 Настенная модульная колонна в комплектации для унитаза/биде

ME 25 ASTA H CM 70
 Barcm70H/BarreHcm70/StangeHcm70

ME 25.06 ASTA PORTASCIUGAMANI CM 25 L
 Towelholder/Porteserviette/Handtuchhalter

ME 25.30 DOSATORE SAPONE LIQUIDO
 Dispensing soap/Dosateurliquide/Sapenger

ME 25.11 PORTA ROTOLO
 Paperholder/Porterouleau/Papierrollenhalter

ME 25.039 PORTA SCOPINO IN OTTONE
 Brass toiletbrush/Portebalayentlaiton/
 Bürstengarnitur aus Messing

COMPOSIZIONE COME FOTO CM 75
 Composition as photo
 Composition comme photo
 Kombination wie auf dem Bild
 Композиция как фото



ME 26

ME 26

Colonna componibile a parete porta salviette
 Modular wall-mounted towel rail column
 Colonne porte-serviettes murale modulaire
 Modulare wandmontierte Handtuchhalter-Säule
 Модульная настенная колонна для полотенцесушителя
 cm 35L x 40H

- 08

MEDEA

realizzata in ottone / realized in brass / réalisée en laiton / aus Messing hergestellt / Сделано из латуни

OGGETTISTICA

_RITO DI PERFEZIONE

Designer: Stilhaus, BGR, Papa, Settimelli

Designer: Stilhaus, BGR, Papa, Settimelli

Designer: Stilhaus, BGR, Papa, Settimelli

Designer: Stilhaus, BGR, Papa, Settimelli

Разработка дизайна: Stilhaus, BGR, Papa, Settimelli





ECO

colori disponibili / available colours / couleurs disponibles / verfügbare Farben



BIANCO
white
blanc
weiß
белый



VERDE
green
vert
grün
зеленый



ROSSO
red
rouge
rot
красный



NERO
black
noir
schwarz
черный



MARRONE
brown
brun
braun
коричневый



GRIGIO
grey
gris
gray
серый



Guarda il video sul nostro canale youtube
Watch the video on our youtube channel
Regardez la vidéo sur notre chaîne Youtube
Sehen Sie sich das Video auf unserem Youtube-Kanal an
Смотрите видео на нашем канале youtube



ECO [design Gianluca Paludi]

1160

Porta spazzolini, diffusore musicale in ceramica
Ceramic toothbrush holder and music speaker
Porte brosse et haut-parleur musical en
ceramique

Zahnbürstenhalter mit Musik-Lautsprecher
aus Keramik

дозатор керамический + подставка для
зубных щёток

cm 14 L x 18 P x 16 H

- Bianco / white / blanc / weiß

- Colorato / colored / coloré / farbig

ECO: Modello registrato EU N. 004544708-0001
ECO: European Patent No. 004544708-0001
ECO: Brevet Européen No. 004544708-0001
ECO: Europäisches Patent Nr. 004544708-0001
ECO: Europäisches патент 004544708-0001

OGGETTISTICA DIFFUSORE PROFUMO

RETTANGOLO

Serie in Neolite
Neolite series
Série Neolite
Neolith-Reihe
серия неолитов

1265

Diffusore di profumo con bacchette
Perfume diffuser with wands
Diffuseur de parfum avec baguettes
Parfümzerstäuber mit Stäben
Парфюмерный диффузор с палочками
cm 10,5 L x 7 P x 14 H

- BI / 08 - 23
- BI / 16 - 17 - 18 - 36
- NE / 08 - 23
- NE / 16 - 17 - 18 - 36



OGGETTISTICA DIFFUSORE PROFUMO

DIVA

Serie in ceramica bianca
White ceramic set
Série en céramique blanc
Serie aus weißer Keramik
серия в белой керамике

1267

Diffusore di profumo con bacchette
Perfume diffuser with wands
Diffuseur de parfum avec baguettes
Parfümzerstäuber mit Stäben
Парфюмерный диффузор с палочками
cm 7 L x 7 P x 20 H

- 08 - 23
- 17 - 18 - 36



LIVING

Serie in ceramica bianca
White ceramic set
Série en céramique blanc
Serie aus weißer Keramik
серия в белой керамике

1266

Diffusore di profumo con bacchette
Perfume diffuser with wands
Diffuseur de parfum avec baguettes
Parfümzerstäuber mit Stäben
Парфюмерный диффузор с палочками
cm 6 L x 9 P x 20 H

- 08 - 23
- 17 - 18 - 36



CRISTALLO

Serie in cristallo
Crystal set
Série en cristal
Serie aus Kristallglas
Серия из стекла

1268

Diffusore di profumo con bacchette
Perfume diffuser with wands
Diffuseur de parfum avec baguettes
Parfümzerstäuber mit Stäben
Парфюмерный диффузор с палочками
cm Ø 7,5 x 14 H

- 08
- 17 - 18 - 36 - 25





RETTANGOLO

Serie in Neolite
Neolite series
Série Neolite
Neolith-Reihe
серия неолитов

1201

Porta sapone
Soap dish/Porte savon/Seifenschale/
Настольная мыльница
cm 13 L x 9 P x 3 H

- BI
- NE

1202

Bicchiere
Glass/Verre/Zahnputzbecher/Настольный стакан
cm 10,5 L x 7 P x 10 H

- BI
- NE

1203

Dosatore sapone
Liquid soap dispenser/Seifenspender/
Dose mit Deckel /настойный дозатор
cm 10,5 L x 7 P x 14 H

- BI / 08 - 23
- BI / 16 - 18 - 36
- NE / 08 - 23
- NE / 16 - 18 - 36



BI 08



BI 18



BI 36



BI 23



BI 16



NE 08



NE 18



NE 36



NE 23



NE 16



TONDO

Serie in Neolite
Neolite series
Série Neolite
Neolith-Reihe
серия неолитов

1204

Porta sapone
Soap dish/Porte savon/Seifenschale/
Настольная мыльница
cm Ø 12 x 3 H

- BI
- NE

1205

Bicchieri
Glass/Verre/Zahnputzbecher/Настольный стакан
cm Ø 7,5 x 13 H

- BI
- NE

1206

Dosatore sapone
Liquid soap dispenser/Seifenspender/
Dose mit Deckel /настойный дозатор
cm Ø 7,5 x 17 H

- BI / 08 - 23
- BI / 16 - 18 - 36
- NE / 08 - 23
- NE / 16 - 18 - 36



BI 08



BI 18



BI 36



BI 23



BI 16



NE 08



NE 18



NE 36



NE 23



NE 16

OGGETTISTICA

MEDEA

Serie in ottone cromato
Chromed brass set
Série en laiton chromée
Serie aus verchromtem Messing
Серия в хроме

ME 09 M AP

Porta sapone
Soap dish / Porte savon / Seifenschale /
мыльница
cm Ø 12 x 11 H

- 08
- 18 - 23 - 24 - 36 - 16
- 17

ME 10 AP

Bicchiere
Glass / Verre / Zahnputzbecher / стакан
cm Ø 6 x 11 H

- 08 - 23 - 24
- 18 - 36 - 16
- 17

ME 30 AP

Dosatore sapone con pompetta in metallo
Liquid soap dispenser / Porte savon liquid /
Seifenspender / Настольный дозатор
cm Ø 6 x 16 H

- 08 - 23 - 24
- 18 - 36 - 16
- 17

URANIA

Serie in ottone cromato
Chromed brass set
Série en laiton chromée
Serie aus verchromtem Messing
серия из металла

981

Porta sapone
Soap dish / Porte savon / Seifenschale /
мыльница
cm 10 L x 10 P x 1 H

- 08

982

Bicchiere
Glass / Verre / Zahnputzbecher / стакан
cm 6 L x 6 P x 11 H

- 08

983

Dosatore sapone con pompetta in metallo
Liquid soap dispenser / Porte savon liquid /
Seifenspender / дозатор
cm 6 L x 6 P x 17 H

- 08



* FINITURA DISPONIBILE IN 20 GG.
Finish available in 20 days
Finition disponible en 20 jours
Oberfläche lieferbar in 20 Tagen
Отделка доступна в течение 20 дней



DIANA

Serie in ottone cromato ovale
Oval chromed brass set
Série en laiton chromée ovale
Serie aus verchromtem Messing oval
серия из металла

917

Porta sapone ovale
Oval soap dish / Porte savon ovale /
Seifenschale oval / овальная мыльница
cm 14 L x 8,5 P x 2 H

- 08

918

Bicchiere ovale
Oval glass / Verre ovale / Zahnputzbecher oval
/ овальный стакан
cm 5,5 L x 8 P x 11 H

- 08

919

Dosatore sapone con pompetta in metallo
Liquid soap dispenser / Porte savon liquid /
Seifenspender / дозатор
cm 5,5 L x 8 P x 16 H

- 08

REGAL

Serie in ottone cromato
Chromed brass set
Série en laiton chromée
Serie aus verchromtem Messing
Серия в хроме

ME 09M AP

Porta sapone
Soap dish / Porte savon / Seifenschale /
мыльница
cm Ø 12 x 2,5 H

- 08

- 16

1130

Bicchiere
Glass / Verre / Zahnputzbecher / стакан
cm Ø 6 x 11 H

- 08

- 16

1131

Dosatore sapone con pompetta in metallo
Liquid soap dispenser / Porte savon liquid /
Seifenspender / Настольный дозатор
cm Ø 6 x 16 H

- 08

- 16



QUEEN TRASPARENTE

Serie in cristallo
Crystal set
Série en cristal
Serie aus Kristallglas
Серия из стекла



1271 TR

Dosatore sapone
Liquid soap dispenser/ Seifenspender /
Dose mit Deckel / настольный дозатор
cm Ø 7,5 x 17 H

• 08
• 16 - 18 - 36

1270 TR

Bicchiere
Glass/Verre/Zahnputzbecher/Настольный стакан
cm Ø 7,5 x 12 H

• vetro / glass / verre / Glas

1269 TR

Porta sapone
Soap dish / Porte savon / Seifenschale /
Настольная мыльница
cm Ø 10 x 4 H

• vetro / glass / verre / Glas

1268 TR

Diffusore di profumo con bacchette
Perfume diffuser with wands
Diffuseur de parfum avec baguettes
Parfümzerstäuber mit Stäben
Парфюмерный диффузор с палочками
cm Ø 7,5 x 14 H

• 08
• 16 - 18 - 36

1272 TR

Contenitore porta kleenex
Kleenex container
Boîte à Kleenex
Kleenex-Behälter
Контейнер для клинекса
cm 13 L x 13 P x 13H

• vetro / glass / verre / Glas

QUEEN AMBRA

Serie in cristallo
Crystal set
Série en cristal
Serie aus Kristallglas
Серия из стекла



1271 AM

Dosatore sapone
Liquid soap dispenser/ Seifenspender /
Dose mit Deckel / настольный дозатор
cm Ø 7,5 x 17 H

• 08
• 16 - 18 - 36

1270 AM

Bicchiere
Glass/Verre/Zahnputzbecher/Настольный стакан
cm Ø 7,5 x 12 H

• vetro / glass / verre / Glas

1269 AM

Porta sapone
Soap dish / Porte savon / Seifenschale /
Настольная мыльница
cm Ø 10 x 4 H

• vetro / glass / verre / Glas

1268 AM

Diffusore di profumo con bacchette
Perfume diffuser with wands
Diffuseur de parfum avec baguettes
Parfümzerstäuber mit Stäben
Парфюмерный диффузор с палочками
cm Ø 7,5 x 14 H

• 08
• 16 - 18 - 36

1272 AM

Contenitore porta kleenex
Kleenex container
Boîte à Kleenex
Kleenex-Behälter
Контейнер для клинекса
cm 13 L x 13 P x 13H

• vetro / glass / verre / Glas

OGGETTISTICA

DIVA [design Massimiliano Settimelli]

Serie in ceramica bianca
White ceramic set
Série en céramique blanc
Serie aus weißer Keramik
серия в белой керамике

DV 09 AP

Porta sapone
Soap dish / Porte savon / Seifenschale /
мыльница
cm 8 L x 12 P x 2 H

• Bianco / white / blanc / weiß

DV 10 AP

Bicchieri
Glass / Verre / Zahnputzbecher / стакан
cm 7 L x 7 P x 14,5 H

• Bianco / white / blanc / weiß

DV 30 AP

Dosatore sapone con pompetta in metallo
Liquid soap dispenser / Porte savon liquid /
Seifenspender / дозатор
cm 7 L x 7 P x 21 H

• Bianco / white / blanc / weiß

DV 14 AP

Porta oggetti
Stowage tray / Plateau / Tablett / лоток
cm 20 L x 10 P x 2 H

• Bianco / white / blanc / weiß

LIVING [design BGR]

Serie in ceramica bianca
White ceramic set
Série en céramique blanc
Serie aus weißer Keramik
серия в белой керамике

LV 09 AP

Porta sapone
Soap dish / Porte savon / Seifenschale /
мыльница
cm 8 L x 12 P x 2 H

• Bianco / white / blanc / weiß

LV 10 AP

Bicchieri
Glass / Verre / Zahnputzbecher / стакан
cm 6 L x 9 P x 14,5 H

• Bianco / white / blanc / weiß

LV 30 AP

Dosatore sapone con pompetta in metallo
Liquid soap dispenser / Porte savon liquid /
Seifenspender / дозатор
cm 6 L x 9 P x 21 H

• Bianco / white / blanc / weiß

-A Bianco / A white / A blanc / A weiß



OGGETTISTICA

CUBE

Serie in ceramica con base ottone cromato
Ceramic set with chromed brass base
Série en céramique avec base en laiton chromée
Serie aus Keramik mit Fuß aus verchromtem Messing
серия из керамики на металлической ножке

616

Porta sapone
Soap dish / Porte savon / Seifenschale /
мыльница
cm 10 L x 10 P x 5 H

• 08

617

Bicchieri
Glass / Verre / Zahnputzbecher / стакан
cm 9 L x 9 P x 12 H

• 08

618

Dosatore sapone con pompetta in metallo
Liquid soap dispenser / Porte savon liquid /
Seifenspender / дозатор
cm 10 L x 7 P x 19 H

• 08

OPERA

Serie in ceramica con base ottone cromato
Ceramic set with chromed brass base
Série en céramique avec base en laiton chromée
Serie aus Keramik mit Fuß aus verchromtem Messing
серия из керамики на металлической ножке

OP 09 AP

Porta sapone
Soap dish / Porte savon / Seifenschale /
мыльница
cm Ø 12 x 5 H

• 08

• 16

• 17

OP 10 AP

Bicchieri
Glass / Verre / Zahnputzbecher / стакан
cm Ø 10 x 12 H

• 08

• 16

• 17

OP 30 AP

Dosatore sapone con pompetta in metallo
Liquid soap dispenser / Porte savon liquid /
Seifenspender / дозатор
cm Ø 10 x 21 H

• 08

• 16

• 17



ZEFIRO [design Claudio Papa]

Serie in ceramica
Ceramic set
Série en céramique
Serie aus Keramik
серия из керамики

652

Porta sapone
Soap dish / Porte savon / Seifenschale /
настоящая мыльница
cm 13 L x 8 P x 2 H

- Bianco / white / blanc / weiß
- Colorato / colored / coloré / farbig

653

Bicchieri
Glass / Verre / Zahnputzbecher /
настойный стакан
cm 13 L x 7 P x 10 H

- Bianco / white / blanc / weiß
- Colorato / colored / coloré / farbig

654

Dosatore sapone con pompetta in metallo
Liquid soap dispenser / Porte savon liquid /
Seifenspender / настольный дозатор
cm 10 L x 7 P x 19 H

- Bianco / white / blanc / weiß
- Colorato / colored / coloré / farbig



ZEFIRO colori disponibili / available colours / couleurs disponibles / verfügbare Farben



BIANCO white blanc weiß белый	VERDE green vert grün зеленый	ROSSO red rouge rot красный	LILLA lilac lille lila сирень	NERO black noir schwarz черный
--	--	--	--	---

LIZ [design Massimiliano Settimelli]

Serie in ceramica
Ceramic set
Série en céramique
Serie aus Keramik
серия из керамики

LZ 09 AP

Porta sapone
Soap dish / Porte savon / Seifenschale /
мыльница
cm 13 L x 9 P x 2,5 H

- 08

LZ 10 AP

Bicchieri
Glass / Verre / Zahnputzbecher / стакан
cm Ø 8 x 11,5 H

- 08

LZ 30 AP

Dosatore sapone con pompetta in metallo
Liquid soap dispenser / Porte savon liquid /
Seifenspender / дозатор
cm Ø 8 x 17 H

- 08



FAUL

Serie in ceramica bianca o colorata
White or coloured ceramic set
Série en céramique blanc ou colorée
Serie aus weißer oder farbiger Keramik
Серия с белой или цветной керамикой

794

Porta sapone
Soap dish / Porte savon / Seifenschale /
мыльница
cm 10 L x 10 P x 2 H

- Bianco / white / blanc / weiß
- Colorato / colored / coloré / farbig

795

Bicchieri
Glass / Verre / Zahnputzbecher / стакан
cm 13 L x 7 P x 10 H

- Bianco / white / blanc / weiß
- Colorato / colored / coloré / farbig

795

Dosatore sapone con pompetta in metallo
Liquid soap dispenser / Porte savon liquid /
Seifenspender / дозатор
cm 7,5 L x 7,5 P x 10 H

- Bianco / white / blanc / weiß
- Colorato / colored / coloré / farbig

- 16 - Oro (maggiorazione)
(supplement)
(supplément)
(Zuschlag)

BUCKET

Serie in ceramica
Ceramic set
Série en céramique
Serie aus Keramik
серия из керамики

BK 09 AP

Porta sapone
Soap dish / Porte savon / Seifenschale /
мыльница
cm Ø 12 x 3,5 H

- 01

- BIOP - NEOP

BK 10 AP

Bicchieri
Glass / Verre / Zahnputzbecher / стакан
cm Ø 9 x 10 H

- 08

- BIOP - NEOP

BK 30 AP

Dosatore sapone con pompetta in metallo
Liquid soap dispenser / Porte savon liquid /
Seifenspender / дозатор
cm Ø 9 x 18 H

- 08

- BIOP - NEOP



BIANCO white blanc weiß белый	VERDE green vert grün зеленый	ROSSO red rouge rot красный	LILLA lilac lille lila сирень	NERO black noir schwarz черный	MARRONE brown brun braun коричневый	GRIGIO grey gris gray серый
--	--	--	--	---	--	--



BIOP

BIANCO OPACO
Matt white
Blanc mat
Mattweiß
матовый белый

NEOP

NERO OPACO
Matt black
Noir mat
Mattschwarz
матовый черный

OGGETTISTICA

EQUILIBRIUM MARMO

Serie in marmo
Marble set
Série en marbre
Serie aus Marmor
Мрамор

EQM 10 AP

Bicchieri in Marmo
Marble glass
Verre marbré
Marmoriertes Glas
Мраморное стекло
cm - Ø 7,5 x 13 H

EQM 30 AP

Dosatore sapone liquido in Marmo
Marble liquid soap dispenser
Distributeur de savon liquide en marbre
Flüssigseifenspender aus Marmor
Мраморный дозатор для жидкого мыла
cm - Ø 7,5 x 17 H

• 08 - 23
• 18 - 36
• 17



OGGETTISTICA

CRACLÈ

Serie in cristallo
Crystal set
Série en cristal
Serie aus Kristallglas
Серия из стекла

1124

Porta sapone
Soap dish/Porte savon/Seifenschale/
Настольная мыльница
cm Ø 13 x 3 H

• TR
• AM - AZ

1125

Bicchiere
Glass/Verre/Zahnputzbecher/Настольный стакан
cm Ø 8 x 9 H

• TR
• AM - AZ

1126

Dosatore sapone
Liquid soap dispenser/Seifenspender/
Dose mit Deckel /настойный дозатор
cm Ø 8 x 18 H

• TR
• AM - AZ

SARA

Serie in vetro bianco o colorato
White or coloured glass set
Série en verre blanc ou colorée
Serie aus weißem oder farbigem Glas
серия из белого или цветного стекла

579

Porta sapone
Soap dish / Porte savon / Seifenschale
/мыльница
cm Ø 12 x 2 H

• 01
• vetrocolorato/coloredglass/verrecoloré
farbiges Glas / витражи

578

Bicchiere
Glass / Verre / Zahnputzbecher / стакан
cm Ø 7 x 9 H

• 01
• vetrocolorato/coloredglass/verrecoloré
farbiges Glas / витражи

580

Dosatore sapone con pompetta in metallo
Liquid soap dispenser / Porte savon liquid /
Seifenspender / дозатор
cm Ø 9 x 18 H

• 01
• vetrocolorato/coloredglass/verrecoloré
farbiges Glas / витражи



SARA colori disponibili / available colours / couleurs disponibles / verfügbare Farben



OGGETTISTICA

MARTE

Serie in vetro con base in ottone
Glass set with brass base
Série en verre avec base en laiton
Serie mit Fuß aus Messing
серия в стекле на металлической ножке

MA 09 AP

Porta sapone
Soap dish / Porte savon / Seifenschale /
мыльница
cm 15 L x 14 P x 12 H
- 08
- 16 - 25 - 36

MA 10 AP

Bicchiere
Glass / Verre / Zahnputzbecher / стакан
cm 9 L x 14 P x 12 H
- 08
- 16 - 25 - 36

MA 30 AP

Dosatore sapone con pompetta in metallo
Liquid soap dispenser / Porte savon liquid /
Seifenspender / дозатор
cm Ø 8 x 18 H
- 08
- 16 - 25 - 36



NOTO

Serie in vetro con base in ottone
Glass set with brass base
Série en verre avec base en laiton
Serie mit Fuß aus Messing
серия в стекле на металлической ножке

NT 09 AP

Porta sapone
Soap dish / Porte savon / Seifenschale /
мыльница
cm Ø 12 x 5 H
- 08
- 16

NT 10 AP

Bicchiere
Glass / Verre / Zahnputzbecher / стакан
cm Ø 9 x 11 H
- 08
- 16

NT 30 AP

Dosatore sapone con pompetta in metallo
Liquid soap dispenser / Porte savon liquid /
Seifenspender / дозатор
cm Ø 8 x 18 H
- 08
- 16



OGGETTISTICA

ELITE

Serie in vetro con base in ottone
Glass set with brass base
Série en verre avec base en laiton
Serie mit Fuß aus Messing
серия в стекле на металлической ножке

EL 09 AP

Porta sapone
Soap dish / Porte savon / Seifenschale / мыльница
cm 15 L x 14 P x 6 H
- 02 - 08
- 16 - 25 - 36

EL 10 AP

Bicchiere
Glass / Verre / Zahnputzbecher / стакан
cm 9 L x 14 P x 12 H
- 02 - 08
- 16 - 25 - 36

EL 30 AP

Dosatore sapone con pompetta in metallo
Liquid soap dispenser / Porte savon liquid /
Seifenspender / дозатор
cm Ø 8 x 18 H
- 02 - 08
- 16 - 25 - 36



GIUNONE

Serie in ceramica bianca con base in ottone
White ceramic set with brass base
Série en céramique blanc avec base en laiton
Serie aus weißer Keramik mit Fuß aus Messing
серия из керамики на металлической ножке

G 719

Porta sapone
Soap dish / Porte savon / Seifenschale / мыльница
cm 13 L x 10 P x 11 H
- 08
- 02 - 03 - 04
- 16 - 25 - 26 - 36

G 718

Bicchiere
Glass / Verre / Zahnputzbecher / стакан
cm 10 L x 15 P x 15 H
- 08
- 02 - 03 - 04
- 16 - 25 - 26 - 36

G 720

Dosatore sapone con pompetta in metallo
Liquid soap dispenser / Porte savon liquid /
Seifenspender / дозатор
cm Ø 12 x 18 H
- 08
- 02 - 03 - 04
- 16 - 25 - 26 - 36



COMPLEMENTI

_GIOCO D'INCASTRI

Designer: Stilhaus, Settimelli, Papa, Paludi
Fuori misura: Sì

Designer: Stilhaus, Settimelli, Papa, Paludi
Customized: Yes

Designer: Stilhaus, Settimelli, Papa, Paludi
Personnalis : Oui

Designer: Stilhaus, Settimelli, Papa, Paludi
Kundenwunsche: Ja

Разработка дизайна: Stilhaus, Settimelli, Papa, Paludi
Негабаритный: да



COMPLEMENTI

1056

Contentore inox
Inox container
Élément mural en acier
Edelstahl-Inox
Контейнер из нержавеющей стали
cm 18 L x 10 P x 18 H

• 55
• 01 - 23

1057

Contentore inox
Inox container
Élément mural en acier
Edelstahl-Inox
Контейнер из нержавеющей стали
cm 36 L x 10 P x 18 H

• 55
• 01 - 23

1058

Contentore inox con porta salviette
Inox container with towerrail
Élément mural en acier avec porte serviettes
Edelstahl-Inox mit Handtuchhalter
Контейнер из нержавеющей стали с
полотенцедержателем
cm 36 L x 10 P x 184 H

• 55
• 01 - 23



1056 01

1056 23



1057 01

1057 23



1058 01

1058 23

COMPLEMENTI

1112

Pensile a 2 piani in inox per specchio
Inox wall unit for mirror
étagère en acier inox à 2 cotes pour miroir
Edelstahl-Ablage mit zwei Fächern
2-х ярусная полка для зеркала
cm 18 L x 14 P x 50 H

• 55

Universale per tutti gli specchi

Universal for all mirrors

Universel pour tous les miroirs

Universell für alle Spiegel

Универсальный для всех зеркал



 Senza fori
Without holes
Sans trous
Ohne Löcher
Без дыр



554

554

Porta asciugamani per lavabo
Towel rail for washbasin
Porte serviette pour lavabo
Handtuchhalter Waschtisch
Полотенцедержатель под умывальник
cm 60 L x 49 P

• 08

COMPLEMENTI

944

Porta piastra per capelli in ottone
Hair straightener holder in brass
Porte lisseur à cheveux
Halter für Haarglätter
Латунь, дверная для волос
cm 5 L x 13 P x 12 H

- 08 - 23

- 16 - 25



16



23



25



955

Porta phon in ottone
Brass hair dryer holder
Porte sèche-cheveux
Föhnhalter
Латунь, дверь Пхон
cm 8 L x 15 P x 7 H

- 08 - 23

- 16 - 25



16



23



25



840

Kit collante e biadesivo per un articolo
Kit with bi-adhesive and glue for one article
Kit avec collant et biadhésif pour un article
Klebekit ist ein beidseitiger Klebestreifen
Возможность установки на клей.Біфдгеш

COMPLEMENTI

1144 OTTO

Porta spazzolini elettrico
Electric toothbrush holder
Porte brosse à dents lectreque
Halter für elektrische Zahnbürsten
Держатель зубной щетки
cm 9 L x 6 P x 5 H

- 08



1145 OTTOPLUS

Porta spazzolino elettrico
Electric toothbrush holder
Porte brosse à dents lectreque
Halter für elektrische Zahnbürsten
Держатель зубной щетки
cm 8 L x 10 P x 9 H

- 08



840

Kit collante e biadesivo per un articolo
Kit with bi-adhesive and glue for one article
Kit avec collant et biadhésif pour un article
Klebekit ist ein beidseitiger Klebestreifen
Возможность установки на клей.Біфдгеш

COMPLEMENTI

1146

Carrello 3 piani in cristallo
3 storey glass trolley
Chariot en verre de 3 étages
Glasböden mit 3 Glasböden
3-х ярусная стеклянная этажерка
cm 40 L x 30 P x 80 H

- 08

- 25 - 16



16



25



COMPLEMENTI

1274

Tavolo bordo vasca con marmo
Marble pool table
Table de pool en marbre
Billardtisch aus Marmor
Мраморный бильярдный стол
cm Ø 32 x 67 H

- 08 - 23

- 18 - 36

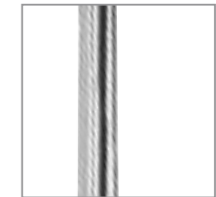

08



23



36

COMPLEMENTI

010 DIECI da appoggio

Positioned to floor
Freistehend
Напольный
См Ø 8 x 41 H

• 08 - 23 - 24
• 16 - 25 - 36

010 M DIECI da parete

Positioned to wall
Wandmontage
Настенный
см 8L x 9 P x 41 H

• 08 - 23 - 24
• 16 - 25 - 36



- 1 Manico e coperchio in ottone cromato
- 2 Sottocoperchio centratore con trattamento antibatterico
- 3 Ciuffo in setola intercambiabile con legatura in filo nichel-silver antiruggine con trattamento antibatterico
- 4 Contenitore interno estraibile in polipropilene con trattamento antibatterico
- 5 Cilindro esterno in ottone cromato
- 6 Base in ABS cromato appoggio soft

- 1 Handle and cover in chrome brass
- 2 Conical self-centering cover with antibacterial treatment
- 3 Bristle tuft interchangeable with nickel / silver ligature with antibacterial treatment
- 4 Removable inner part in polypropylene plastic with antibacterial treatment
- 5 Outer cylinder in chrome plated brass
- 6 Base in chromed abs, soft set down

- 1 Poignée et couvercle en laiton chromé
- 2 Centrage Innerplate avec traitement antibactérien
- 3 Touffe Bristle interchangeable avec reliure spirale rouille nickel-argent traitement antimicrobien
- 4 Récipient intérieur amovible en polypropylène avec traitement antibactérien
- 5 Cylindre externe laiton chromé
- 6 Base en ABS chrome appui douce

- 1 Stiel und Deckel aus verchromtem Messing
- 2 Zentrier-Topfschale mit antibakterieller Behandlung
- 3 Austauschbarer Bürstenkopf mit antibakterieller Behandlung
- 4 Herausnehmbarer Polypropylen-Einsatz mit antibakterieller Behandlung
- 5 Behälter aus verchromtem Messing
- 6 ABS-verchromter Soft-Touch-Fuß

- 1 Ручка и крышка из хромированной латуни
- 2 под крышкой центрирующее устройство с антибактериальное лечение
- 3 сменные насадки в переплете с никелево-серебряной антикоррозионной нитью с антибактериальное лечение
- 4 внутренний выдвижной контейнер из полипропилена с антибактериальное лечение
- 5 внешний цилиндр из хромированной латуни
- 6 основа из ABS



TRATTAMENTO ANTIBATTERICO

antibacterial treatment
traitement antibactérien
antibakteriell behandelt
антибактериальное лечение

TRATTAMENTO ANTIBATTERICO

antibacterial treatment
traitement antibactérien
antibakteriell behandelt
антибактериальное лечение



- 1 Manico e coperchio in ottone cromato
- 2 Sottocoperchio centratore con trattamento antibatterico
- 3 Ciuffo in setola intercambiabile con legatura in filo nichel-silver antiruggine con trattamento antibatterico
- 4 Contenitore interno estraibile in polipropilene con trattamento antibatterico
- 5 Cilindro esterno in ottone cromato
- 6 Base in ABS cromato appoggio soft

- 1 Handle and cover in chrome brass
- 2 Conical self-centering cover with antibacterial treatment
- 3 Bristle tuft interchangeable with nickel / silver ligature with antibacterial treatment
- 4 Removable inner part in polypropylene plastic with antibacterial treatment
- 5 Outer cylinder in chrome plated brass
- 6 Base in chromed abs, soft set down

- 1 Poignée et couvercle en laiton chromé
- 2 Centrage Innerplate avec traitement antibactérien
- 3 Touffe Bristle interchangeable avec reliure spirale rouille nickel-argent traitement antimicrobien
- 4 Récipient intérieur amovible en polypropylène avec traitement antibactérien
- 5 Cylindre externe laiton chromé
- 6 Base en ABS chrome appui douce

- 1 Stiel und Deckel aus verchromtem Messing
- 2 Zentrier-Topfschale mit antibakterieller Behandlung
- 3 Austauschbarer Bürstenkopf mit antibakterieller Behandlung
- 4 Herausnehmbarer Polypropylen-Einsatz mit antibakterieller Behandlung
- 5 Behälter aus verchromtem Messing
- 6 ABS-verchromter Soft-Touch-Fuß

- 1 Ручка и крышка из хромированной латуни
- 2 под крышкой центрирующее устройство с антибактериальное лечение
- 3 сменные насадки в переплете с никелево-серебряной антикоррозионной нитью с антибактериальное лечение
- 4 внутренний выдвижной контейнер из полипропилена с антибактериальное лечение
- 5 внешний цилиндр из хромированной латуни
- 6 основа из ABS

020 VENTI da appoggio

Positioned to floor
Freistehend
Напольный
см 9,5 L x 9,5 P x 41 H

• 08 - 23
• 16 - 36

020 M VENTI da parete

Positioned to wall
Wandmontage
Настенный
см 9,5 L x 10,5 P x 41 H

• 08 - 23
• 16 - 36





1200 SWITCH BIANCO

Porta scopino in ceramica a parete e da appoggio
 Wall mounted and on floor ceramic toilet brush
 Porte balayent en céramique d'appui et à mur
 Bürstengarnitur aus Keramik zur Wandmontage
 oder freistehend
 Настенный и напольный керамический ёрш
 cm 12 L x 13,5 P x 40 H

• 08 - 23
 • 16 - 18 - 36



SWITCH colori disponibili

available colours / couleurs disponibles / verfügbare Farben / доступные цвета



Guarda il video sul nostro canale youtube / Watch the video on our youtube channel
 Regardez la vidéo sur notre chaîne Youtube / Sehen Sie sich das Video auf unserem Youtube-Kanal an
 Смотрите видео на нашем канале youtube



Brevetto Europeo N. 7794383-001
 European Patent No. 7794383-001
 Brevet Européen No. 7794383-001
 Europäisches Patent Nr. 7794383-001
 Европейский патент No 7794383-001

1200 SWITCH NERO

Porta scopino in ceramica a parete e da appoggio
 Wall mounted and on floor ceramic toilet brush
 Porte balayent en céramique d'appui et à mur
 Bürstengarnitur aus Keramik zur Wandmontage
 oder freistehend
 Настенный и напольный керамический ёрш
 cm 12 L x 13,5 P x 40 H

• 08 - 23
 • 16 - 18 - 36

Brevetto Europeo N. 7794383-001
 European Patent No. 7794383-001
 Brevet Européen No. 7794383-001
 Europäisches Patent Nr. 7794383-001
 Европейский патент No 7794383-001



SWITCH colori disponibili

available colours / couleurs disponibles / verfügbare Farben / доступные цвета



COMPLEMENTI

1946

Scopini adatti a sanitari a risparmio idrico
 Wall mounted toilet brush suitable for
 water-saving sanitary ware
 Broses de toilettes adaptées aux sanitaires à
 économie d'eau
 Toilettenbürsten geeignet für wassersparende
 Sanitärprodukte
 Туалетные щетки подходят для
 водосберегающей сантехники
 cm 6,5 L x 8 P x 32 H

• 08 - 23 - 24

• 16 - 18 - 36

• 17



840

Kit collante e biadesivo per un articolo
 Kit with bi-adhesive and glue for one article
 Kit avec collant et biadhésif pour un article
 Klebekit ist ein beidseitiger Klebestreifen
 Возможность установки на клей.Біфдгеш

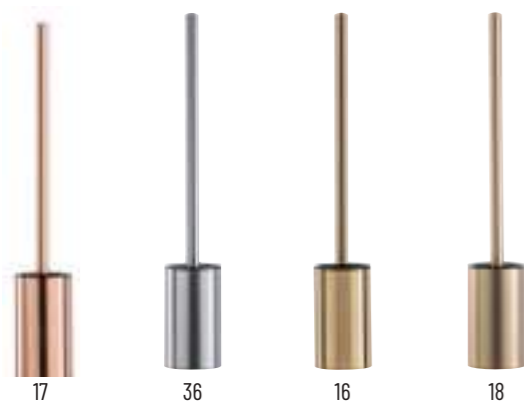

COMPLEMENTI

1948

Scopini adatti a sanitari a risparmio idrico
 Wall mounted toilet brush suitable for
 water-saving sanitary ware
 Broses de toilettes adaptées aux sanitaires à
 économie d'eau
 Toilettenbürsten geeignet für wassersparende
 Sanitärprodukte
 Туалетные щетки подходят для
 водосберегающей сантехники
 cm 6,5 L x 8 P x 32 H

• 08 - 23



840

Kit collante e biadesivo per un articolo
 Kit with bi-adhesive and glue for one article
 Kit avec collant et biadhésif pour un article
 Klebekit ist ein beidseitiger Klebestreifen
 Возможность установки на клей.Біфдгеш



COMPLEMENTI

VE 039 PRATIKO

Porta scopino da appoggio con coperchio telescopico
Toilet brush with telescopic cover
Porte balayent d'appui avec couvercle télescopique
Bürstengarnitur freistehend mit Teleskopgriff
Напольный металлический ёрш с телескопической крышкой
cm Ø 12,5 x 54 H

- 08



VE 039 PRATIKO

646 ZEFIRO [design Claudio Papa]

Porta scopino in ceramica da appoggio con diffusore di profumo e una essenza profumata
Ceramic toilet brush with scent diffuser and one perfumed essence
Porte balayent en céramique d'appui avec diffuseur de parfume et une essence parfumée
Bürstengarnitur aus Keramik freistehend mit Duftspender und Duftessenz
Напольный керамический ёрш с ароматизатором
cm 13 L x 10 P x 42 H

-08 bianco/white/blanc/weiß/белый

-08 colorato/colored/colorée/farbig/цветной



ZEFIRO colori disponibili / available colours / couleurs disponibles / verfügbare Farben / доступные цвета



BIANCO
white / blanc /
weiß / белый



VERDE
green / vert /
grün / зеленый



ROSSO
red / rouge /
rot / красный



ARANCIO
orange / orangier /
orange / оранжевый



LILLA
lilac / lile /
lila / сирень



NERO
black / noir /
schwarz / черный

COMPLEMENTI

AR 039

Porta scopino ovale in ottone da appoggio
Oval brass toilet-brush with base
Porte balayent oval en laiton d'appui
Bürstengarnitur freistehend oval aus Messing
Напольный металлический ёрш

cm 9 L x 10 P x H 38

- 08

- 36

AR 039 M

Porta scopino ovale in ottone a parete
Wall-mounted oval brass toilet-brush
Porte balayent oval en laiton à mur
Bürstengarnitur wandhängend oval aus Messing
Настенный металлический ёрш

cm 9 L x 10 P x H 38

- 08

- 36



AR 039 / AR 039 M

U 039Q URANIA

Porta scopino in ottone da appoggio
Brass toilet-brush with base
Porte balayent en laiton d'appui
Bürstengarnitur freistehend aus Messing
Напольный металлический ёрш

cm 8 L x 8 P x 41 H

- 08 - 23

- 36

URANIA



U 039Q / U 039 M

U 039M URANIA

Porta scopino quadrato in ottone a parete
Wall mounted square brass toilet-brush
Porte balayent cadre en laiton à mur
Bürstengarnitur wandhängend aus Messing
Настенный металлический ёрш

cm 8 L x 9 P x 41 H

- 08

- 36

COMPLEMENTI

995

Porta scopino in ABS e in ottone
ABS or brass toilet brush holder
Porte-brosse de toilette en ABS ou en laiton
Toilettenbürstenhalter aus ABS oder Messing
Держатель туалетного ершика из ABS или латуни
cm Ø 9 x 43 H

- 08 ABS Cromo /
- 23 ABS Nero /

1215 TONDO

Porta scopino da appoggio INOX 304
INOX 304 toilet-brush with base
Porte balayent d'appui INOX 304
Bürstengarnitur freistehend aus INOX 304
Держатель щётки для унитаза из нержавеющей стали 304
cm Ø 8 x 42 H

- 55
- 56

1216 QUADRATO

Porta scopino da appoggio INOX 304
INOX 304 toilet-brush with base
Porte balayent d'appui INOX 304
Bürstengarnitur freistehend aus INOX 304
Держатель щётки для унитаза из нержавеющей стали 304
cm 9 L x 9 P x 41 H

- 55
- 56

SM 039 CIKO

Porta scopino in ottone da appoggio
con base in PVC
Brass toilet brush with PVC base
Porte balayent en laiton d'appui avec base en PVC
Bürstengarnitur aus Messing freistehend mit
Sockel aus PVC
Напольный металлический ёрш
cm Ø 8 x 36 H

- 08
- 02
- 16 - 25

SM 039M CIKO

Porta scopino in ottone a parete
Wall mounted brass toilet brush
Porte balayent en laiton à mur
Bürstengarnitur wandhängend aus Messing
Настенный металлический ёрш
cm Ø 9 x 36 H

- 08
- 02
- 16 - 25

i 039

Porta scopino da appoggio con base
Toilet brush with base
Porte balayent d'appui
Bürstengarnitur freistehend
Напольный металлический ёрш
cm 12,5 Ø x 40 H

- 08
- 16 - 25

390_COMPLEMENTI



995 23



995 08



1216



1215

CIKO



SM 039 / SM 039 M



i 039



186

GABRY



186.40

CUBE



633



DV 12 A



i 12 A



BK 12 A

COMPLEMENTI

186 GABRY

Porta scopino in ceramica da appoggio
Ceramic toilet brush with base
Porte balayent en céramique d'appui
Bürstengarnitur freistehend aus Keramik
Напольный керамический ёрш
cm 13 Ø x 35 H

- 02 - 08
- 39
- 40

633 CUBE

Porta scopino in ceramica da appoggio
Ceramic toilet-brush with base
Porte balayent en céramique d'appui
Bürstengarnitur freistehend aus Keramik
Напольный керамический ёрш
cm 10 L x 10 P x 38 H

- 08
- 36

DV 12 A [design Massimiliano Settimelli]

Porta scopino in ceramica da appoggio
Ceramic toilet brush with base
Porte balayent en céramique d'appui
Bürstengarnitur freistehend aus Keramik
Напольный керамический ёрш
cm 10L x10 P x 40 H

- 08

i 12 A

Porta scopino in ceramica da appoggio
Ceramic toilet brush with base
Porte balayent en céramique d'appui
Bürstengarnitur freistehend aus Keramik
Напольный керамический ёрш
cm 13 Ø x 40 H

- 08
- 25 - 26

BK 12 A [design Giovanna Talocci]

Porta scopino in ceramica
Ceramic Toilet-brush
Porte balayent en céramique
Bürstengarnitur wandhängend
Напольный керамический ёрш
cm Ø 10 x 42 H

- 08



TT 01

Maniglione di sicurezza in ottone cm 30
Brass safety handle cm 30
Poignée de sécurité en laiton cm 30
Sicherheitsgriff aus Messing cm 30
Латунная предохранительная ручка см 30
cm 35,5 L x 8 P x 3 H

• 08 - 03 - 05
• 36

TT 02

Maniglione di sicurezza in ottone cm 45
Brass safety handle cm 45
Poignée de sécurité en laiton cm 45
Sicherheitsgriff aus Messing cm 45
Латунная предохранительная ручка см 45
cm 45,5 L x 8 P x 3 H

• 08 - 03 - 05
• 36

TT 03

Maniglione di sicurezza in ottone cm 60
Brass safety handle cm 60
Poignée de sécurité en laiton cm 60
Sicherheitsgriff aus Messing cm 60
Латунная предохранительная ручка см 60
cm 60,5 L x 8 P x 3 H

• 08 - 03 - 05
• 36

TT 04

Maniglione di sicurezza in ottone cm 80
Brass safety handle cm 80
Poignée de sécurité en laiton cm 80
Sicherheitsgriff aus Messing cm 80
Латунная предохранительная ручка см 80
cm 80,5 L x 8 P x 3 H

• 08 - 03 - 05
• 36



TT 05

Asta per connessione a "T" cm 30
Rod for "T" connection cm 30
Tige pour raccord en "T" cm 30
Stange für "T"-Verbindung cm 30
Стержень для "Т" соединения см 30
cm 38,5 L x 8,5 P x 3,5 H

• 08 - 03 - 05
• 36

TT 06

Asta per connessione a "T" cm 45
Rod for "T" connection cm 45
Tige pour raccord en "T" cm 45
Stange für "T"-Verbindung cm 45
Стержень для "Т" соединения см 45
cm 48,5 L x 8,5 P x 3,5 H

• 08 - 03 - 05
• 36

TT 07

Asta per connessione a "T" cm 60
Rod for "T" connection cm 60
Tige pour raccord en "T" cm 60
Stange für "T"-Verbindung cm 60
Стержень для "Т" соединения см 60
cm 63,5 L x 8,5 P x 3,5 H

• 08 - 03 - 05
• 36

TT 08

Asta per connessione a "T" cm 80
Rod for "T" connection cm 80
Tige pour raccord en "T" cm 80
Stange für "T"-Verbindung cm 80
Стержень для "Т" соединения см 80
cm 83,5 L x 8,5 P x 3,5 H

• 08 - 03 - 05
• 36



TT 09

Maniglione di sicurezza in ottone cm 120
Brass safety handle cm 120
Poignée de sécurité en laiton cm 120
Sicherheitsgriff aus Messing cm 120
Латунная предохранительная ручка см 120
cm 120,9 L x 8,5 P x 3 H

• 08 - 03 - 05
• 36

TT 10

Doccetta completa di supporto e tubo
Shower complete with stand and hose
Douche complète avec support et tuyau
Dusche komplett mit Ständer und Schlauch
Душ в комплекте со стойкой и шлангом
cm 120,9 L x 4 P x 5 H

• 08
• 03 - 05

TT 51

Porta accappatoio per barra
Bathrobe holder for bar
Support de peignoir pour le bar
Bademantelhalter für Stange
Держатель банного халата для барной стойки
cm 6,5 L x 4 P x 5 H

• 08 - 03 - 05
• 36

TT 12

Vaschetta plexiglass per barra orizzontale
Plexiglas tray for horizontal bar
Plateau en plexiglas pour barre horizontale
Plexiglasschale für horizontale Stange
Лоток из оргстекла для горизонтальной полосы
cm 25 L x 14 P x 12 H

•
•



TT04 + TT08 + TT10+TT12



TT12



TT02



TT04 + TT10 + TT11

TT 1283

Maniglia reclinabile
Reclining handle
Poignée inclinable
Verstellbarer Griff
Откидывающаяся ручка
BASE cm 9 L x 16 H
APERTA cm 65 P x 16 H
CHIUSA cm 12 P x 75 H

• 08 - 03 - 05
• 36



TT 1283

TT 1284

Maniglia reclinabile con porta rotolo
Reclining handle with roll holder
Poignée inclinable avec porte-rouleau
Verstellbarer Griff mit Rollenhalter
Откидывающаяся ручка с держателем для рулона
BASE cm 9 L x 16 H
APERTA cm 65 P x 16 H
CHIUSA cm 12 P x 75 H

• 08 - 03 - 05
• 36



TT 1284



08



05

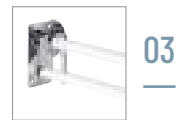

03



36



1152

Maniglione di sicurezza in ottone ad angolo
 Brass mergency handle
 Poignée de sûreté en laiton
 Bad Sicherheitsgriff aus Messing
 Поручень
 cm 47 L x 10 P x 18 H x Ø 3

.....
 - 08

 - 16 - 25



1152

1153

Maniglione di sicurezza in ottone
 Brass mergency handle
 Poignée de sûreté en laiton
 Bad Sicherheitsgriff aus Messing
 Поручень
 cm 35 L x 9 P x 6 H x Ø 3

.....
 - 08

 - 16 - 25



1153

1154

Maniglione di sicurezza in ottone
 Brass mergency handle
 Poignée de sûreté en laiton
 Bad Sicherheitsgriff aus Messing
 Поручень
 cm 45 L x 9 P x 6 H x Ø 3

.....
 - 08

 - 16 - 25



1154

1155

Maniglione di sicurezza in ottone
 Brass mergency handle
 Poignée de sûreté en laiton
 Bad Sicherheitsgriff aus Messing
 Поручень
 cm 60 L x 9 P x 6 H x Ø 3

.....
 - 08

 - 16 - 25



1155

1156

Maniglione di sicurezza in ottone
 Brass mergency handle
 Poignée de sûreté en laiton
 Bad Sicherheitsgriff aus Messing
 Поручень
 cm 80 L x 9 P x 6 H x Ø 3

.....
 - 08

 - 16 - 25



1156



16

25



1147

Maniglione di sicurezza in ottone ad angolo
 Brass mergency handle
 Poignée de sûreté en laiton
 Bad Sicherheitsgriff aus Messing
 Поручень
 cm 47 L x 10 P x 18 H x Ø 3

- 08
 - 36

1148

Maniglione di sicurezza in ottone
 Brass mergency handle
 Poignée de sûreté en laiton
 Bad Sicherheitsgriff aus Messing
 Поручень
 cm 35 L x 9 P x 6 H x Ø 3

- 08
 - 36

1149

Maniglione di sicurezza in ottone
 Brass mergency handle
 Poignée de sûreté en laiton
 Bad Sicherheitsgriff aus Messing
 Поручень
 cm 45 L x 9 P x 6 H x Ø 3

- 08
 - 36

1150

Maniglione di sicurezza in ottone
 Brass mergency handle
 Poignée de sûreté en laiton
 Bad Sicherheitsgriff aus Messing
 Поручень
 cm 60 L x 9 P x 6 H x Ø 3

- 08
 - 36

1151

Maniglione di sicurezza in ottone
 Brass mergency handle
 Poignée de sûreté en laiton
 Bad Sicherheitsgriff aus Messing
 Поручень
 cm 80 L x 9 P x 6 H x Ø 3

- 08
 - 36

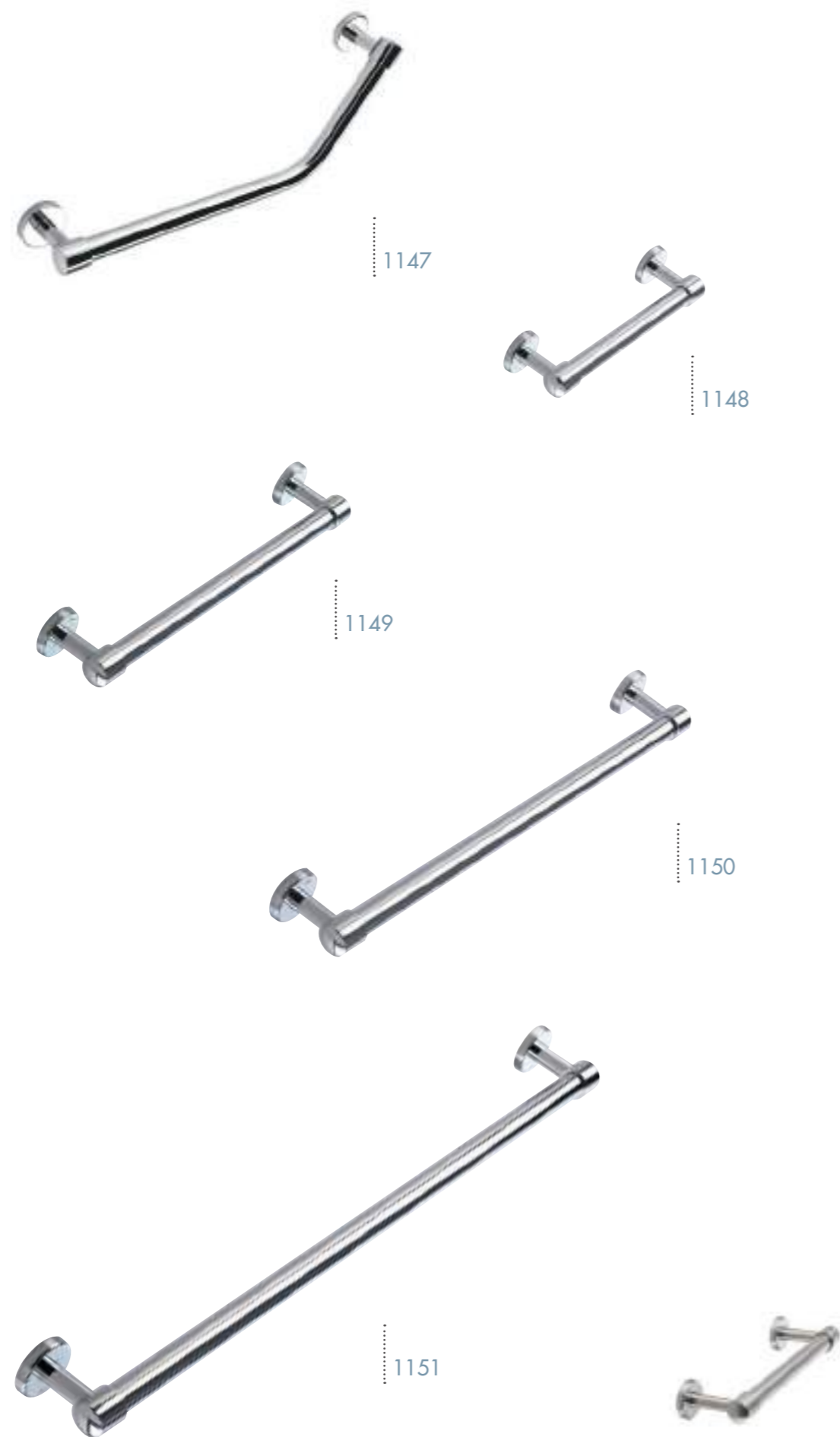

36



233 / 1231

Maniglione di sicurezza in ottone ad angolo
 Brass mergency handle
 Poignée de sûreté en laiton
 Bad Sicherheitsgriff aus Messing
 Поручень
 cm 41 L x 10 P x 18 H x Ø 2

- 1231 08 **HQC**
- 233 08
- 233 16 - 233 25



233
1231

884 / 1235

Maniglione di sicurezza in ottone con griglia
 Brass mergency handle with rack
 Poignée de sûreté en laiton avec grille
 Bad Sicherheitsgriff mit Seifenkorb
 Поручень + решетка
 cm 42 L x 11,5 P x 16 H x Ø 2

- 1235 08 **HQC**
- 884 08
- 884 16 - 884 25



884
1235

885 / 1232

Maniglione di sicurezza in ottone
 Brass mergency handle
 Poignée de sûreté en laiton
 Bad Sicherheitsgriff
 Поручень
 cm 30 L x 10 P x 5 H x Ø 2

- 1232 08 **HQC**
- 885 08
- 885 16 - 885 25



885
1232

886 / 1233

Maniglione di sicurezza in ottone
 Brass mergency handle
 Poignée de sûreté en laiton
 Bad Sicherheitsgriff
 Поручень
 cm 45 L x 10 P x 5 H x Ø 2

- 1233 08 **HQC**
- 886 08
- 886 16 - 886 25



886
1233

887 / 1234

Maniglione di sicurezza in ottone
 Brass mergency handle
 Poignée de sûreté en laiton
 Bad Sicherheitsgriff
 Поручень
 cm 60 L x 10 P x 5 H x Ø 2

- 1234 08 **HQC**
- 887 08
- 887 16 - 887 25



887
1234



16

25



076

Asta per tenda doccia
 Brass support bar for tent
 Barre de supporte en laiton pour tende
 Stange aus Messing für Duschvorhang
 Угловая перекалдина для занавесок в ванную
 cm 80 L x 80 P x Ø 2

- 08
- 25 - 16



076

082

Asta per tenda vasca con rompi tratta
 Brass support bar for tent
 Barre de supporte en laiton pour tende
 Stange aus Messing für Duschvorhang
 Угловая перекалдина для занавесок в ванную
 cm 170 L x 80 P x Ø 2

- 08
- 25 - 16



082

078

Asta curva per tenda doccia
 Brass curved support bar for tent
 Barre de supporte courbe en laiton pour tende
 Stange rund aus Messing für Duschvorhang
 Полукруглая перекалдина для занавесок в ванную
 cm 80 L x 80 P x Ø 2 R 55

- 08
- 25 - 16



078



079

Asta per tenda doccia
 Brass support bar for tent
 Barre de supporte en laiton pour tende
 Stange aus Messing für Duschvorhang
 Полукруглая перекалдина для занавесок в ванную
 cm 88/90 L x Ø 2

- 08
- 25 - 16



079

	
ORO Gold Gold золото	BRONZO Bronze Bronze Бронза
16	25





075 *
Tenda doccia in tessuto di poliestere plastificato
Polyester material shower tent
Tende douche dans tissu de polyester
Duschvorhang Textil aus Polyester
Душевая занавеска из полиэстера

- 075.00 cm 120 L x 200 H
- 075.01 cm 180 L x 200 H
- 075.02 cm 240 L x 200 H



075 NIDO D'APE BIANCO *
Tenda doccia in tessuto di poliestere plastificato
Polyester material shower tent
Tende douche dans tissu de polyester
Duschvorhang Textil aus Polyester
Душевая занавеска из полиэстера

- 075.01 APBI cm 180 L x 200 H



075 NIDO D'APE ECRÙ *
Tenda doccia in tessuto di poliestere plastificato
Polyester material shower tent
Tende douche dans tissu de polyester
Duschvorhang Textil aus Polyester
Душевая занавеска из полиэстера

- 075.01 APEC cm 180 L x 200 H



075 CRASH BIANCO *
Tenda doccia in tessuto di poliestere plastificato
Polyester material shower tent
Tende douche dans tissu de polyester
Duschvorhang Textil aus Polyester
Душевая занавеска из полиэстера

- 075.01 CRBI cm 180 L x 200 H



075 LINEUM BIANCO *
Tenda doccia in tessuto di poliestere plastificato
Polyester material shower tent
Tende douche dans tissu de polyester
Duschvorhang Textil aus Polyester
Душевая занавеска из полиэстера

- 075.01 LMBI cm 180 L x 200 H



075 LINEUM ECRÙ *
Tenda doccia in tessuto di poliestere plastificato
Polyester material shower tent
Tende douche dans tissu de polyester
Duschvorhang Textil aus Polyester
Душевая занавеска из полиэстера

- 075.01 LMEC cm 180L x 200 H



080
Supporto in ottone per tenda doccia
Brass support for tent
Supporte en laiton pour tende
Aufhängung aus Messing für Duschvorhang
Круглая перекалдина для занавесок в ванную
cm 80 Ø x 84 P x 10 H

- 08 € 440,00
- 25 - 16 € 550,00

083
Ganci per tenda doccia
Curtain hooks for tent
Crochets de rideau pour tende
Vorhanghaken
Крючок для занавесок
cm 3 L x 6 H

- 55 € 1,60

8 pz x tenda / tent / tende / Vohrang / nanaka cm 120 L
12 pz x tenda / tent / tende / Vohrang / nanaka cm 180 L
16 pz x tenda / tent / tende / Vohrang / nanaka cm 240 L



083

COMPLEMENTI

036

Sedile per doccia con seduta in legno
Seat for shower with wood sitting
Siège pour douche avec séance en bois
Duschsitz in Holz
Сиденье в душевой угол из дерев
cm 35 L x 37 P

- 01

Kg 100 Carico statico
Staticload/Chargestatique/StatischeBelastung



036

643

Sedile doccia, alluminio e polipropilene
Aluminum and polypropylene seat for shower
Siège pour douche, aluminium et polypropylène
Duschsitz in Aluminium und Polypropylen
Сиденье в душевой угол
cm 12/47 P x 42 L

- 01

Kg 110 Carico statico
Staticload/Chargestatique/StatischeBelastung
CE norma MDD 93/42



643

033.01

Sedile per vasca con seduta in plastica
Seat for bath-tub with plastic sitting
Siège pour baignoire avec séance en plastique
Badewannensitz aus Kunststoff
Сиденье для ванны
cm 65/70 L x 28 P x 18 H

- 01

Kg 80 Carico statico
Staticload/Chargestatique/StatischeBelastung



033.01

COMPLEMENTI

1085 - SEDILE DOCCIA

Sedile doccia in acciaio e plexiglass
Steel and plexiglass seat for shower
Siège pour douche en acier et plexiglass
Duschsitz aus Stahl und Plexiglas
Сиденье в душевой угол
cm 32 L x 7/33 P x 33/7 H

- 55

Kg 160 Carico statico
Staticload/Chargestatique/StatischeBelastung



COMPLEMENTI

839

HQC

Pulisci vetri con supporto, ad incollo
Shower door wiper, with glue
Nettayeur de douche, pour coller
Glaswischer mit Wandhalterung aus verchromtem Messing zum Kleben
Стеклоочиститель для стекла не более 10 мм

- 08



839

1078

Pulisci vetri con porta accappatoio singolo, per vetro da 10 mm max
Shower door wiper, for glass of 10 mm maximum
Nettayeur de douche, pour un verre de 10 mm maximum
Glaswischer mit Wandhalterung für Glas von maximal 10 mm
Стеклоочиститель для стекла не более 10 мм

- 08



1078

985

Porta accappatoio doppio per vetro da 10 mm max
Robe hook, for glass of 10 mm maximum
Porte peignoir, pour un verre de 10 mm maximum
Bademantelhaken, für Glas von maximal 10 mm
Крючок для стекла не более 10 мм

- 08

- 16 - 25



985

COMPLEMENTI

964

Gancio porta accappatoio OTTONE
Bathrobe hook BRASS
Crochet pour peignoir BRASS
Bademantelhaken BRASS
Крючок для халата BRASS

- 08

- 16 - 25



16

25



964



936 TR

936 BI

936 NE

936

Gancio porta accappatoio PLEXIGLASS
Plexiglass bathrobe hook
Crochet pour peignoir en plexiglas
Bademantelhaken aus Plexiglas
Крючок для халата из оргстекла

- TR - BI - NE

984

Porta accappatoio singolo per vetro da 10 mm max
Robe hook, for glass of 10 mm maximum
Porte peignoir, pour un verre de 10 mm max.
Bademantelhaken, für Glas von maximal 10 mm
Крючок для стекла не более 10 мм

- 08

- 16 - 25



984

COMPLEMENTI

1087

Mensola in plexiglass ad angolo con balconcino
Shelf with plexyglass planeand balcony
Console avec plateau en Plexyglas et balconnet
Ablage aus klarem plexiglass mit Halteleiste
полка из оргстекла с ограничителем
cm 20 L x 20 P x 12,5 H

- 08

1088

Mensola ad angolo con balconcino DX + SX
Shelf with plexyglass planeand balcony
Console avec plateau en plexyglass et balconnet
Ablage aus klarem Plexyglas mit Halteleiste
полка угловая с ограничителем правая/левая
cm 25 L x 16 P x 12,5 H

- 08



1089

Mensola in plexiglass con balconcino
Shelf with plexyglass planeand balcony
Console avec plateau en plexyglass et balconnet
Ablage aus klarem Plexyglas mit Halteleiste
полка из оргстекла с ограничителем
cm 26 L x 11 P x 12,5 H

- 08

1090

Mensola in plexiglass con balconcino
Shelf with plexyglass planeand balcony
Console avec plateau en Plexyglas et balconnet
Ablage aus klarem Plexiglass mit Halteleiste
полка из оргстекла с ограничителем
cm 40 L x 11 P x 12,5 H

- 08



1087



1088



1089



1090



1046



1044



1045

COMPLEMENTI

1046

Pensile doccia a parete
Double shelf for wall
Structure a mur avec 2 plateaux
Korbgestell , 2 Ablagen
Решётка в ванную 2-х уровневая
cm 26 L x 11 P x 52 H

- 08

1044

Pensile doccia per pannello fisso
Double shelf for glass shower
Structure avec 2 plateaux et 2 porte peignoir
Korbgestell mit 2 Ablagen, 2 Haken
Решётка 2-х + 2 крючка для душевого угла
cm 26 L x 11 P x 55 H

- 08

1045

Pensile doccia per box con anta scorrevole
Double shelf for glass shower with sliding doors
Structure avec 2 plateaux et porte peignoir
Korbgestell für Dusche mit Schiebetüren,
rechteckig, mit 2 Haken für Bademäntel
Решётка 2-х + 2 крючка для душевого угла
cm 26 L x 11 P x 56 H

- 08

**Per ante scorrevoli
(profilo cm 4 massimo)**

For sliding doors (profile cm 4 maximum)

Pour porte coulissantes (profil cm 4 maximum)

Für Schiebetüren (Profil cm 4 maximal)

для раздвижных дверей

(максимальный профиль 4 см)

COMPLEMENTI

1218

Mensola in plexiglass, fissaggio con viti
Shelf with plexiglass, screws fixing
Console avec plateau en plexiglass, fixation avec vis
Ablage aus klarem Plexiglass, Befestigung mit Schrauben
Оргстеклянная полка, крепление винтами
cm 25 L x 10 P x 7,5 H

- 08



1219



Mensola in plexiglass, fissaggio con colla
Shelf with plexiglass, Glue fixing
Console avec plateau en plexiglass, fixation avec de la colle
Ablage aus klarem Plexiglass, Befestigung mit Klebstoff
Оргстеклянная полка, крепление клеем
cm 25 L x 10 P x 7,5 H

- 08



COMPLEMENTI

1172

Pensile doccia rettangolare con 2 piani e 2 porta accappatoio
Rectangular structure for shower with 2 shelves and 2 robe-hook
Structure rectangulaire avec 2 plateaux et 2 porte peignoir
Korbgestell rechteckig mit 2 Ablagen, 2 Haken
Решётка 2-х уровневая + 2 крючка для душевого угла
cm 25 L x 20 P x 72 H

- TR



1171

Pensile doccia per box con anta scorrevole
Double shelf for glass shower with sliding doors
Structure avec 2 plateaux et porte peignoir
Korbgestell für Dusche mit Schiebetüren, rechteckig, mit 2 Haken für Bademäntel
Решётка 2-х + 2 крючка для душевого угла
cm 25 L x 20 P x 72 H

- TR

Per ante scorrevoli (profilo cm 4,5 massimo)

For sliding doors (profile cm 4,5 maximum)
Pour porte coulissantes (profil cm 4,5 maximum)
Für Schiebetüren (Profil cm 4,5 maximal)
для раздвижных дверей
(максимальный профиль 4,5 см)



RACK Designer Markus Binz

1220

Mensola in INOX 316, fissaggio con Viti
Shelf with INOX 316 screws fixing
Console avec plateau en INOX 316, fixation avec vis
Ablage aus klarem INOX 316, Befestigung mit Schrauben
Полка из нержавеющей стали 316, крепление винтами
cm 25 L x 10 P x 7,5 H

- 54
- 23



1221



Mensola in INOX 316, fissaggio con colla
INOX 316 shelf, fixing with glue
Étagère en ACIER INOXYDABLE 316, fixation avec de la colle
Ablage aus EDELSTAHL 316, Befestigung mit Klebstoff
Полка из нержавеющей стали 316, крепление клеем
cm 25 L x 10 P x 7,5 H

- 54
- 23



Designer Markus Binz RACK

1223

Pensile doccia rettangolare con 2 piani e 2 porta accappatoio
Rectangular structure for shower with 2 shelves and 2 robe-hook
Structure rectangulaire avec 2 plateaux et 2 porte peignoir
Korbgestell rechteckig mit 2 Ablagen, 2 Haken
Решётка 2-х уровневая + 2 крючка для душевого угла
cm 25 L x 20 P x 72 H

- 54
- 23

1226

Pensile doccia per box con anta scorrevole
Double shelf for glass shower with sliding doors
Structure avec 2 plateaux et porte peignoir
Korbgestell für Dusche mit Schiebetüren, rechteckig, mit 2 Haken für Bademäntel
Решётка 2-х + 2 крючка для душевого угла
cm 25 L x 11 P x 60 H

- 54
- 23

Per ante scorrevoli (profilo cm 4,5 massimo)

For sliding doors (profile cm 4,5 maximum)
Pour porte coulissantes (profil cm 4,5 maximum)
Für Schiebetüren (Profil cm 4,5 maximal)
для раздвижных дверей
(максимальный профиль 4,5 см)

COMPLEMENTI

1254

Angolare in plexiglass, fissaggio con viti
Plexiglass corner, screw fixing
Angle en plexiglas, fixation par vis
Plexiglas-Ecke, Schraubbefestigung
Уголок из оргстекла, винтовое крепление
cm 31 L x 15 P x 6 H

- 08



1255



Angolare in plexiglass, fissaggio con colla
Plexiglass corner, fixing with glue
Coin de plexiglas, fixation par colle
Plexiglas-Ecke, Befestigung mit Kleber
Уголок из оргстекла, крепление с помощью клея
cm 31 L x 15 P x 6 H

- 08



1256

Pensile doccia angolare con
2 piani e 2 porta accappatoio
Corner shower cabinet with 2 shelves and 2
bathrobe holders
Cabine de douche d'angle avec 2 étagères et 2
porte-peignoirs de bain
Eck-Duschkabine mit 2 Ablagen und 2 Bade-
mantelhaltern
Угловая душевая кабина с 2 полки и 2
держателя для халатов
cm 31 L x 20 P x 72 H

- TR

1257

Pensile doccia angolare per box con anta
scorrevole
Corner shower wall unit for sliding door box
Colonne de douche d'angle pour cabine de
douche à porte coulissante
Eck-Duschwand für Schiebetürkasten
Угловой душевой настенный блок для бокса с
раздвижной дверью
cm 31 L x 20 P x 72 H

- TR

Per ante scorrevoli (profilo cm 4,5 massimo)

For sliding doors (profilo cm 4,5 maximum)
Pour porte coulissantes (profil cm 4,5 maximum)
Für Schiebetüren (Profil cm 4,5 maximal)
для раздвижных дверей
(максимальный профиль 4,5 см)

RACK Designer Markus Binz

1292

Angolare in INOX 316, fissaggio con viti
Angle bracket made of INOX 316, screw fixing
Support angulaire en acier inoxydable 316,
fixation par vis
Winkelkonsole aus Edelstahl 316, Schraubbe-
festigung
Угловой кронштейн из нержавеющей стали
316, винтовое крепление
cm 31 L x 15 P x 6 H

- 54

- 23



1293



Angolare in INOX 316, fissaggio con colla
Angle made of INOX 316, fixing with glue
Angle en INOX 316, fixation par collage
Winkel aus INOX 316, Befestigung mit Klebstoff
Угол из INOX 316, крепление с помощью клея
cm 31 L x 15 P x 6 H

- 54

- 23



Designer Markus Binz RACK

1294

Pensile doccia angolare per box con anta fissa
Corner shower enclosure with fixed door
Colonne de douche d'angle pour porte fixe
Eckduschwand für Kasten mit fester Tür
Угловой душевой настенный блок для
фиксированного дверного блока
cm 31 L x 20 P x 72 H

- TR - 54

- TR - 23

1295

Pensile doccia angolare per box con anta
scorrevole
Corner shower wall unit for sliding door box
Colonne de douche d'angle pour cabine de
douche à porte coulissante
Eck-Duschwand für Schiebetürkasten
Угловой душевой настенный блок для бокса с
раздвижной дверью
cm 31 L x 20 P x 72 H

- TR - 54

- TR - 23

Per ante scorrevoli (profilo cm 4,5 massimo)

For sliding doors (profile cm 4,5 maximum)
Pour porte coulissantes (profil cm 4,5 maximum)
Für Schiebetüren (Profil cm 4,5 maximal)
для раздвижных дверей
(максимальный профиль 4,5 см)

COMPLEMENTI

1296

Angolare in plexiglass con 2 ripiani
Plexiglass corner unit with 2 shelves
Unité d'angle en plexiglas avec 2 étagères
Plexiglas-Eckschrank mit 2 Fachböden
Угловой шкаф из оргстекла с 2 полками
cm 31 L x 15 P x 43 H

- TR



1297

Angolare in INOX 316 con 2 ripiani
316 stainless steel corner unit with 2 shelves
Unité d'angle en acier inoxydable 316 avec 2 étagères
Eckschrank aus Edelstahl 316 mit 2 Einlegeböden
Угловой блок из нержавеющей стали 316 с 2 полками
cm 31 L x 15 P x 43 H

- TR - 54

- TR - 23



COMPLEMENTI

1298

Pensile in plexiglass con 2 ripiani
Plexiglass wall unit with 2 shelves
Unité murale en plexiglas avec 2 étagères
Plexiglas-Wandschrank mit 2 Einlegeböden
Настенный шкаф из оргстекла с 2 полками
cm 26 L x 12 P x 43 H

- TR



1299

Pensile in INOX 316 con 2 ripiani
INOX 316 wall unit with 2 shelves
Unité murale INOX 316 avec 2 étagères
Hängeschrank INOX 316 mit 2 Regalen
Настенный шкаф INOX 316 с 2 полками
cm 26 L x 12 P x 43 H

- TR - 54

- TR - 23



COMPLEMENTI

785

Pensile doccia rettangolare con 2 piani e 2 porta accappatoio
 Rectangular structure for shower with 2 shelves and 2 robe-hook
 Structure rectangulaire avec 2 plateaux et 2 porte peignoir
 Korbgestell rechteckig mit 2 Ablagen, 2 Haken
 Решётка 2-х уровневая + 2 крючка для душевого угла
 cm 25 L x 12P x 53 H

- 08



785

822

Griglia rettangolare con 2 piani per doccia
 Brass rectangular grill, 2 shelves for shower
 Grille rectangulaire eulaiton avec 2 plateaux
 Korbgestell rechteckig aus Messing, 2 Ablagen
 Решётка в ванную 2-х уровневая
 cm 25 L x 12 P x 52 H

- 08



822

COMPLEMENTI

773

Pensile doccia rettangolare adatto a box doccia con anta scorrevole, con 2 porta accappatoio
 Rectangular structure for shower with 2 shelves and robe-hook
 Structure rectangulaire avec 2 plateaux et porte peignoir
 Korbgestell für Dusche mit Schiebetüren, rechteckig, mit 2 Haken für Bademäntel
 Решётка 2-х уровневая + крючок для душевого угла
 cm 26 L x 55 H - P int. 12

- 08

Foto: versione sinistra
 Photo: left version
 Photo: version gauche
 Auf dem Bild: linke Ausführung
 Фото: Левый версия



Per ante scorrevoli (profilo cm 6 massimo)

For sliding doors (profile cm 6 maximum)
 Pour porte coulissantes (profil cm 6 maximum)
 Für Schiebetüren (Profil cm 6 maximal)
 для раздвижных дверей
 (максимальный профиль 6 см)

Brevetto Europeo N. 272623
 European Patent No. 272623
 Brevet Européen No. 272623
 Europäisches Patent Nr. 272623
 Европейский патент No 272 623



COMPLEMENTI

1300

Pensile doccia rettangolare con 2 piani e 2 porta accappatoio
 Rectangular structure for shower with 2 shelves and 2 robe-hook
 Structure rectangulaire avec 2 plateaux et 2 porte peignoir
 Korbgestell rechteckig mit 2 Ablagen, 2 Haken
 Решётка 2-х уровневая + 2 крючка для душевого угла
 cm 30 L x 13 P x 54 H

- 08



1301

Pensile doccia rettangolare adatto a box doccia con anta scorrevole, con 2 porta accappatoio
 Rectangular structure for shower with 2 shelves and robe-hook
 Structure rectangulaire avec 2 plateaux et porte peignoir
 Korbgestell für Dusche mit Schiebetüren, rechteckig, mit 2 Haken für Bademäntel
 Решётка 2-х уровневая + крючок для душевого угла
 cm 30 L x 12 P x 55 H

- 08

Foto: versione sinistra
 Photo: left version
 Photo: version gauche
 Auf dem Bild: linke Ausführung
 Фото: Левый версия



COMPLEMENTI

1071

Griglia porta spugna in ottone
 Brass grill sponge holder
 Grille porte éponge en laiton
 Korbgestell, Schwammhalter aus Messing
 Решётка в ванную
 cm 34 L x 13,5 P x 7 H

- 08

 Possibilità di fissaggio ad incollo
 Possibility of installation by glue
 Possibilité de fixation par colle
 Befestigungsmöglichkeit mit Klebstoff
 Возможность крепления на клей



840

Kit collante e biadesivo per un articolo
 Kit with bi-adhesive and glue for one article
 Kit avec collant et biadhésif pour un article
 Klebekit ist ein beidseitiger Klebestreifen
 Возможность установки на клей.Б/фдгеш

1072

Pensile doccia rettangolare con 1 piano e 2 porta accappatoio
 Rectangular structure for shower with 1 shelf and 2 robe-hook
 Structure rectangulaire avec 1 plateau et 2 porte peignoir
 Korbgestell rechteckig mit 1 Ablagen, 2 Haken
 Решётка 1-х уровневая + 2 крючка для душевого угла
 cm 31 L x 13,5 P x 35 H

- 08



1071



1072

COMPLEMENTI

1121

Griglia porta spugna in ottone ad angolo
Brass grill sponge holder
Grille porte éponge en laiton
Korbgestell, Schwammhalter aus Messing
Решётка угловая с ограничителем правая/левая
cm 25 L x 16 P x 8 H

- 08 dx
- 08 sx

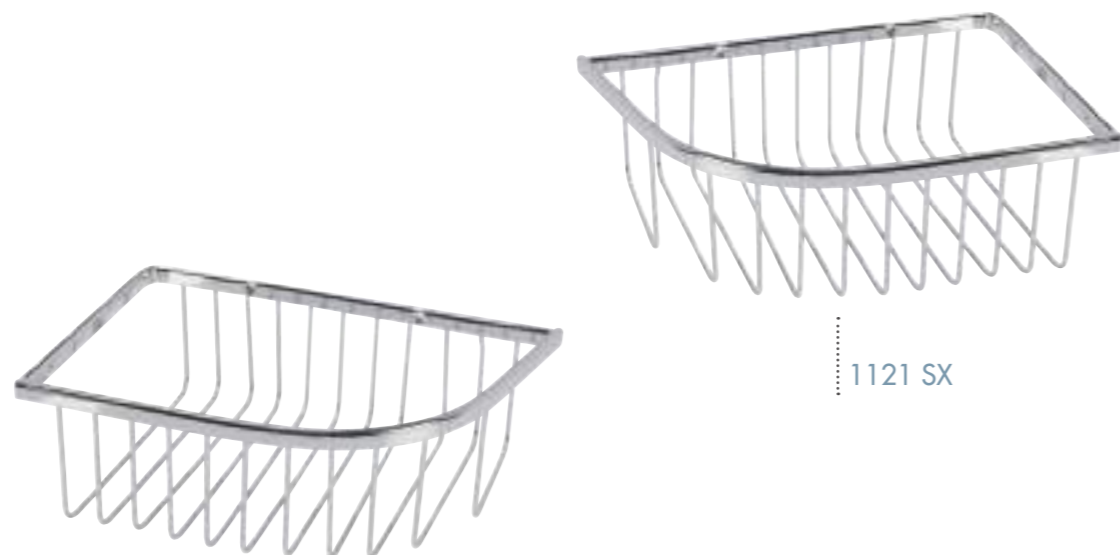

1121 SX



1121 DX

D15

Griglia porta spugna in ottone
Brass grill sponge holder
Grille porte éponge en laiton
Korbgestell, Schwammhalter aus Messing
Решётка в ванную
cm 25 L x 12 P x 8 H

- 08 - 23
- 16 - 25



+ 1007

D 15

868

Griglia angolare per doccia
Brass grill for shower
Grille angulaire
Korbgestell eckig für Dusche
Решётка в ванную
cm 27 L x 27 P x 7 H

- 08



+ 1007

868

1007

Set per incollo con colla
Metal part for fixing with glue
Plaque métallique pour fixation avec colle
Blech eckig für zum Kleben links
Крепеж на клей
cm Ø5

- 08
- 16 - 25



1007

COMPLEMENTI

872

Griglia porta spugna in ottone
Brass grill sponge holder
Grille porte éponge en laiton
Korbgestell, Schwammhalter aus Messing
Решётка в ванную
cm 28,5 L x 12,5 P x 7 H

- 08



872

873

Griglia porta spugna in ottone
Brass grill sponge holder
Grille porte éponge en laiton
Korbgestell, Schwammhalter aus Messing
Решётка в ванную
cm 40 L x 12,5 P x 7 H

- 08



873

875

Griglia angolare in ottone per doccia
Brass corner grill for shower
Grille angulaire en laiton pour douche
Korbgestell eckig aus Messing für Dusche
Решётка в ванную
cm 29 L x 20 P x 6 H

- 08



875

874

Griglia angolare in ottone per doccia
Brass corner grill for shower
Grille angulaire en laiton pour douche
Korbgestell eckig aus Messing für Dusche
Решётка в ванную
cm 26 L x 18 P x 6 H

- 08



874

COMPLEMENTI

571

Griglia angolare in ottone per doccia
Brass corner grill for shower
Grille angulaire en laiton pour douche
Korbgestell eckig aus Messing für Dusche
Решётка в ванную
cm 21 L x 12 P x 5 H

• 08
• 23
• 16 - 25



570

Griglia angolare in ottone con 2 ripiani
Brass corner grill with 2 shelves
Grille angulaire en laiton avec 2 plateaux
Korbgestell eckig aus Messing mit 2 Ablagen
Решётка в ванную 2-х уровневая
cm 20 L x 12 P x 29 H

• 08
• 23
• 16 - 25



569

Griglia angolare in ottone con 3 ripiani
Brass corner grill with 3 shelves
Grille angulaire en laiton avec 3 plateaux
Korbgestell eckig aus Messing mit 3 Ablagen
Решётка в ванную 3-х уровневая
cm 20 L x 12 P x 54 H

• 08
• 23
• 16 - 25

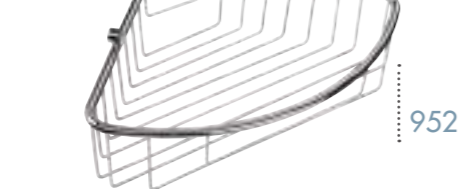

952

Griglia angolare in ottone
Brass corner grill
Grille angulaire en laiton
Korbgestell eckig aus Messing
Решётка в ванную
cm 29 L x 20 P x 7 H

• 08



879

Griglia angolare in ottone con 2 ripiani
Brass corner grill with 2 shelves
Grille angulaire en laiton avec 2 plateaux
Korbgestell eckig aus Messing mit 2 Ablagen
Решётка в ванную 2-х уровневая
cm 30 L x 20 P x 34 H

• 08



1007

Set per incollo con colla
Metal part for fixing with glue
Plaque métallique pour fixation avec colle
Blech eckig für zum Kleben links
Крепеж на клей
cm Ø5

• 08
• 16 - 25



1007



16

23

25



570

COMPLEMENTI

048

Struttura angolare sospesa in ottone con due ripiani in Vedral e 2 ganci

Wall mounted corner brass structure with 2 Vedral shelves and 2 hooks

Structure à angle suspendue en laiton avec 2 plateaux en Vedral et 2 crochets

Gestell eckig aus Messing mit 2 Ablagen aus Vedral und 2 Haken

Решётка 2-х уровневая + 2 крючка в ванную

cm 22 L x 13 P x 40 H

• 08



048

844

Mensola da 8 mm con balconcino

Shelf 8 mm with balcony

Console de 8 mm et balconnet

Ablage aus 8 mm mit Halteleiste

Стекланная полка с ограждением - толщина стекла 8 мм

cm 35 L x 25 P x 5 H

• 08

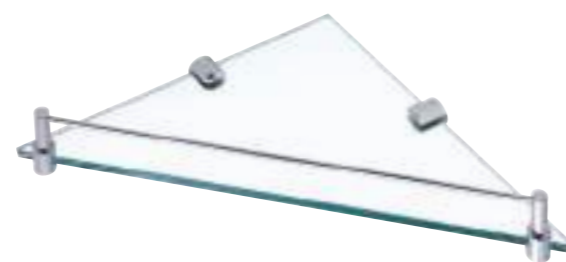

844

G 693 GIUNONE

Angolare in ottone con 3 ripiani in Vedral

Wall mounted corner brass with 3 Vedral shelves

Angulaire en laiton avec 3 plateaux en Vedral

Gestell eckig aus Messing mit 3 Ablagen aus Vedral

Решётка 3-х уровневая в ванную

cm 22 L x 13 P x 45 H

• 08

• 02

• 16 - 25 - 26 - 36



G 693

EL 31 ELITE

Angolare in ottone con 3 ripiani in Vedral

Wall mounted corner brass with 3 Vedral shelves

Angulaire en laiton avec 3 plateaux en Vedral

Gestell eckig aus Messing mit 3 Ablagen aus Vedral

Решётка 3-х уровневая в ванную

cm 22 L x 13 P x 45 H

• 08

• 02

• 16 - 25 - 26 - 36



EL 31



EL 31

COMPLEMENTI

RL 80

Struttura rettangolare sospesa in ottone con 2 ripiani in cristallo 5 mm

Wall mounted rectangular brass structure with 2 crystal glass shelves 5 mm

Structure rectangulaire suspendue en laiton avec 2 plateaux en cristal 5 mm

Gestell rechteckig aus Messing mit 2 Ablagen aus Kristallglas 5 mm

Стеклянная полка 2-х уровневая с ограждением см 45 L x 11 P x 45 H

• 08 - 10 - 23

• 36



RL 80

EL 694 ELITE

Struttura rettangolare sospesa in ottone con 2 ripiani in cristallo 5 mm

Wall mounted rectangular brass structure with 2 crystal glass shelves 5 mm

Structure rectangulaire suspendue en laiton avec 2 plateaux en cristal 5 mm

Gestell rechteckig aus Messing mit 2 Ablagen aus Kristallglas 5 mm

Стеклянная полка 2-х уровневая с ограждением см 45 L x 15 P x 38 H

• 08

• 02

• 16 - 25 - 26 - 36



EL 694



G 694

G 694 GIUNONE

Struttura rettangolare sospesa in ottone con 2 ripiani in cristallo 5 mm

Wall mounted rectangular brass structure with 2 crystal glass shelves 5 mm

Structure rectangulaire suspendue en laiton avec 2 plateaux en cristal 5 mm

Gestell rechteckig aus Messing mit 2 Ablagen aus Kristallglas 5 mm

Стеклянная полка 2-ух уровневая с ограждением см 45 L x 15 P x 38 H

• 08

• 02

• 16 - 25 - 26 - 36

Z 04

Mensola da 8mm

Shelf 8mm

Console 8mm

Ablage 8 mm

Стеклянная полка - толщина стекла 8 мм

см 60 L x 12 P x 2 H

• 08

Su misura
onmeasure/surmesure/maßgeschneiderte/настроили

• 08 - cm 30/59

• 08 - cm 61/100

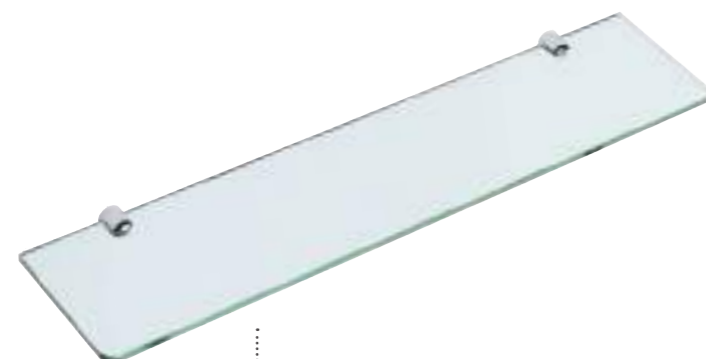

Z 04



766 SMART

Mensola da 8 mm e balconcino

Shelf with 8 mm crystal glass plane and balcony

Console avec plateau en cristal de 8 mm et balconnet

Ablage aus klarem Kristallglas 8 mm mit Halteleiste

Стеклянная полка с ограждением - толщина стекла 8 мм

• 08 - cm 40 L x 14 P x 7 H

• 08 - cm 30 L x 14 P x 7 H



819 MEDEA

Mensola da 8 mm con balconcino

Shelf with 8 mm crystal glass plane and balcony

Console avec plateau en cristal de 8 mm et balconnet

Ablage aus klarem Kristallglas 8 mm mit Halteleiste

Стеклянная полка с ограждением - толщина стекла 8 мм

• 08 - cm 40 L x 14 P x 7 H

• 08 - cm 30 L x 14 P x 7 H



820 URANIA

Mensola da 8 mm con balconcino

Shelf with 8 mm crystal glass plane and balcony

Console avec plateau en cristal de 8 mm et balconnet

Ablage aus klarem Kristallglas 8 mm mit Halteleiste

Стеклянная полка с ограждением - толщина стекла 8 мм

• 08 - cm 40 L x 14 P x 7 H

• 08 - cm 30 L x 14 P x 7 H

COMPLEMENTI

997

Sgabello contenitore inox 304 con ecopelle
Stainless steel and ecoleather container for lingerie
Container pour linge inox et faux cuir
Edelstahl-Wäschekorb
корзина для белья на стене
cm 32 L x 32 P x 52 H

- 55
- 24 - 23
- 16 - 25



997 - 55



997 - 24



997 - 23



COMPLEMENTI

638

Sgabello con 4 gambe
Stool with 4 legs
Tabouret avec 4 jambes
Hocker mit 4 Beinen
Стул на 4-х ножках
cm Ø 37 x 39 H

- 01

Kg 100 Carico statico
Staticload/Chargestatique/StatischeBelastung/
статическая нагрузка
CE norma MDD 93/42



638



650

650

Sgabello con 4 gambe
Stool with 4 legs
Tabouret avec 4 jambes
Hocker mit 4 Beinen
Стул на 4-х ножках
cm Ø 36 x 40 H

- 08

Kg 110 Carico statico
Staticload/Chargestatique/StatischeBelastung/
статическая нагрузка
CE norma MDD 93/42



1137/TR



1137/01



1137/23

1137

Sgabello plexiglass
Plexiglass stool
Tabouret en plexiglass
Hocker mit Plexiglas
оргстекло стул
cm 28 L x 25 P x 44 H

- TR

- 01 - 23

Kg 110 Carico statico
Staticload/Chargestatique/StatischeBelastung/
статическая нагрузка

Certificato - UNI EN 14183



979

979

Sgabello plexiglass
Plexiglass stool
Tabouret en plexiglass
Hocker mit Plexiglas
оргстекло стул
cm 28 L x 28 P x 44 H

- 08

COMPLEMENTI

994

Cestino con coperchio
ELITE / MARTE / IDRA
Dustbin with cover
Panier avec couverture
Korb mit Deckel
Контейнер для мусора
cm Ø 21 x 25 H

- 08
- 16 - 25



08



25



16

994

Cestino con coperchio
PRISMA / NEMI / NOTO / NOTO LIGHT
Dustbin with cover
Panier avec couverture
Korb mit Deckel
Контейнер для мусора
cm Ø 21 x 25 H

- 08
- 16 - 25



994 EL



994 MA



994 PR



994 NE



994 NTV



994 NT

Designer Gianluca Paludi STEP-BOX

1199

Sgabello plexiglass con getta rifiuti inox 304
Plexiglass stool with stainless steel 304 waste disposal
Tabouret en plexiglas avec élimination des déchets en acier inoxydable 304
Hocker aus Plexiglas mit Abfallentsorgung aus Edelstahl 304
Стул из оргстекла с утилизацией отходов из нержавеющей стали 304
cm 28 L x 25 P x 44 H

- 01 - 23



1199 - 01



1199 - 23

HOTELLERIE

_VARIETÀ, FUNZIONALITÀ E STILE

Designer: Stilhaus
Fuori misura: No

Designer: Stilhaus
Customized: No

Designer: Stilhaus
Personnalisé: No

Designer: Stilhaus
Kundenwünsche: Nein

Разработка дизайна: Stilhaus
Негабаритный: не



PERSONALIZZAZIONE LASER

laser customisation / personnalisation du laser
Laserindividualisierung / лазерная персонализация

Possibilità di personalizzare accessori o prodotti con il logo o il nome della struttura alberghiera (pag. 463)

Accessories or products can be customized with the logo or name of the hotel (pag. 463).

Possibilité de personnaliser des accessoires ou des produits avec le logo ou le nom de l'hôtel (pag. 463).

Produkten mit dem Logo oder Namen des Hotels (p. 463).

Возможность персонализации аксессуаров или продуктов с логотипом или названием отеля (стр. 463)



**VE 04**

Mensola con piano in vetro trasparente 8 mm
Shelf with transparent glass plane 8 mm
Etagère avec plan en verre transparent 8 mm
Ablage aus klarem Glas 8 mm
Стеклоплатформа - толщина стекла 8 мм
cm 60 L x 12 P x 5 H

- 08

**LZ 05**

Asta porta asciugamani
Towel rail
Porte serviette
Handtuchhalter
Полотенцедержатель
cm 61 L x 7 P x 5 H

- 08

**LZ 05.2**

Porta asciugamani doppia asta
Towel rail 2 bars
Porte serviette avec 2 bar
Doppel-Handtuchstange
олотенцедержатель двойной
cm 65 L x 11 P x 5 H

- 08

**LZ 10 M**

Porta bicchiere in ottone
Brass glass holder
Porte verre en laiton
Zahnbürstenhalter aus Messing
Настенный металлический стакан
cm 7 L x 11 P x 11 H

- 08

**LZ 30 V**

Porta dosatore sapone liquido
Wall-mounted liquid soap dispenser
Doseur de savon liquid
Seifenspender
Настенный стеклянный дозатор для мыла
cm 5 L x 9 P x 18 H

- 08

**LZ 11**

Porta rotolo
Paper holder
Porte rouleau
Papierrollenhalter
Настенный бумагодержатель
cm 17 L x 7 P x 4,5 H

- 08

**LZ 45**

Asta porta asciugamani
Towel rail
Porte serviette
Handtuchhalter
Полотенцедержатель
cm 50 L x 7 P x 5 H

- 08

**LZ 06**

Asta porta salviette
Serviette holder
Porte serviettes
Handtuchhalter
Полотенцедержатель
cm 36 L x 7 P x 5 H

- 08

**LZ 07**

Anello porta salviette
Serviette holder to ring shaped
Porte serviettes à anneau
Handtuchring
Полотенцедержатель - кольцо
cm 23 Ø x 5 P x 26 H

- 08

**LZ 11 S**

Porta rotolo di scorta
Paper holder of supply
Porte rouleau d'escorte
Ersatzpapierrollenhalter
Вертикальный бумагодержатель
cm 5 L x 7 P x 17 H

- 08

**1167**

Porta rotolo di scorta
Spare roll holder
Porte-rouleau de rechange
Ersatz-Rollenhalter
Держатель запасного валика
cm 10 L x 2,5 P x 14 H

- 08

**LZ 11C**

Porta rotolo con coperchio
Covered paper holder
Porte rouleau avec couvercle
Papierrollenhalter mit Deckel
Настенный бумагодержатель закрытый
cm 14 L x 12 P x 13 H

- 08

**LZ 09 V**

Porta sapone in vetro
Glass soap dish
Porte savon en verre
Seifenschale aus Glas
Настенная стеклянная мыльница
cm 12 L x 12 P x 8 H

- 08

**LZ 09 M**

Porta sapone in ottone
Brass soap dish
Porte savon en laiton
Seifenschale aus Messing
Настенная металлическая мыльница
cm 12 L x 8 P x 9 H

- 08

**LZ 10 V**

Porta bicchiere in vetro
Glass holder
Porte verre en verre
Zahnbürstenhalter aus Glas
Настенный стеклянный стакан
cm 7 L x 10 P x 9 H

- 08

**LZ 11.2**

Porta rotolo doppio
Paper holder of supply
Porte rouleau d'escorte
Doppel - Papierrollenhalter
Настенный бумагодержатель двойной
cm 25,5 L x 7 P x 5 H

- 08

**1005**

Porta rotolo INOX coperto
INOX covered paper holder
Porte rouleau avec couvercle en INOX
Papierrollenhalter INOX mit Deckel
Настенный бумагодержатель закрытый
cm 12 L x 13 P x 6 H

- 08

**LZ 809**

Porta accappatoio (2 ganci)
Robe hook (2 hooks)
Porte peignoir (2 crochets)
Bademantelhaken (2 Haken)
Крючок
cm 5,5 L x 5,5 P x 5,5 H

- 08



VE 13/1

Porta accappatoio (1 gancio)
Robe hook (1 hook)
Porte peignoir (1 crochet)
Bademantelhaken (1 Haken)
Крючок
cm 1 L x 4 P x 1 H

- 08



VE 13/3

Porta accappatoio (3 ganci)
Robe hook (3 hooks)
Porte peignoir (3 crochets)
Bademantelhaken (3 Haken)
Крючок тройной
cm 15 L x 4,5 P x 2 H

- 08



LZ 039

Porta scopino in ottone
Brass toilet-brush
Porte balayent en laiton
Bürstengarnitur aus Messing
Напольный
cm 8 Ø x 42 H

- 08



748

Griglia portasciugamani con 6 aste
Towel holder grill with 6 bars
Grille porte serviettes avec 6 barres
Badetuchablage mit Handtuchhalter 6 Stangen
Решётка для полотенец - 6 прутьев
cm 48 L x 28 P x 10 H

- 08

- 23



786

Griglia portasciugamani con 6 aste
Towel holder grill with 6 bars
Grille porte serviettes avec 6 barres
Badetuchablage mit Handtuchhalter 6 Stangen
Решётка для полотенец - 6 прутьев
cm 54 L x 28 P x 11 H

- 08

- 23



1236

Griglia portasciugamani con 6 aste
Towel holder grill with 6 bars
Grille porte serviettes avec 6 barres
Badetuchablage mit Handtuchhalter 6 Stangen
Решётка для полотенец - 6 прутьев
cm 63 L x 30 P x 10 H

- 08

HQC



LZ 039 M

Porta scopino a parete
Wall mounted toilet-brush
Porte balayent à mur
Bürstengarnitur wandhängend
Настенный металлический ёрш
cm 8 Ø x 42 H

- 08



1215

Porta scopino INOX 304
Brass toilet-brush
Porte balayent en laiton
Bürstengarnitur aus Messing
Напольный
cm 8 Ø x 42 H

- 55



1215 M

Porta scopino a parete INOX 304
Wall mounted toilet-brush
Porte balayent à mur
Bürstengarnitur wandhängend
Настенный металлический ёрш
cm 8 Ø x 42 H

- 55



493

Distributore asciugamani di carta in acciaio inox 304
Stainless steel distributor paper towels
Distributif serviettes de papier en acier inox
Papierhandtuchspender aus Edelstahl
Ящик для бумажных полотенец
cm 25 L x 12 P x 42 H

- 55

- 23

- 16 - 18



23



981

Distributore fazzoletti carta inox
Distributor handkerchiefs paper inox
Distributif mouchoirs papier inox
Spender für Kosmetiktücher inox
Ящик для листовой бумаги inox
cm 26 L x 12 P x 10 H

- 55

- 23

- 16 - 18

23

55



981 INC

Distributore fazzoletti carta da incasso
Paper handkerchief dispenser
Distributeur de mouchoirs en papier
Spender für Papiertaschentücher
Дозатор бумажных носовых платков
cm 26 L x 12 P x 10 H

- 55



1216

Porta scopino INOX 304
Brass toilet-brush
Porte balayent en laiton
Bürstengarnitur aus Messing
Напольный
cm 8 L x 8 P x 41 H

- 55



1216 M

Porta scopino a parete INOX 304
Wall mounted toilet-brush
Porte balayent à mur
Bürstengarnitur wandhängend
Настенный металлический ёрш
cm 8 L x 8 P x 41 H

- 55



995 08

Porta scopino in ABS
ABS toilet brush
Porte balayent en ABS
Bürstengarnitur aus ABS
Напольный АБС
cm Ø 9 x 43 H

- 08



1122

Distributore fazzoletti carta inox
Distributor handkerchiefs paper inox
Distributif mouchoirs papier inox
Spender für Kosmetiktücher inox
Ящик для листовой бумаги inox
cm 14 L x 12,5 P x 13 H

- 55

- 23

- 16 - 18



23

16 / 18



K 27

Distributore sacchetti igienici ABS
Sanitary bags dispenser
Distributif sachets hygiénique
Hygienebeutel Spender
Дозатор для гигиенических пакетов
cm 13 L x 5 P x 29 H

- 08

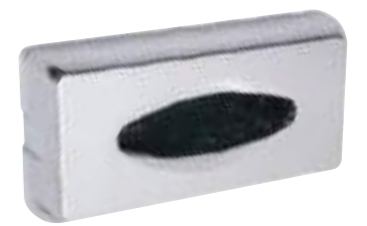

K 24

Distributore fazzoletti carta ABS
Distributor handkerchiefs paper ABS
Distributif mouchoirs papier ABS
Spender für Kosmetiktücher ABS
Ящик для листовой бумаги ABS
cm 26 L x 12 P x 5 H

- 08



K 19

Distributore asciugamani, fogli carta C o rotoli
Distributor towels in sheets paper C and rolls
Distributif serviettes, papier C or tu rouleaux
Papierhandtuchspender für C-Falz Handtücher oder Rollen
Ящик для гигиенической рулонной бумаги
cm 30 L x 19,5 P x 25 H

- 01

495

Distributore sapone liquido (Lt.1,2) in acciaio inox
Stainless steel distributor liquid soap (Lt.1,2)
Distributif de savon liquide (Lt.1,2) en acier inox
Seifenspender (Lt.1,2) aus Edelstahl
Дозатор для мыла - 1,2 литра
cm 10 L x 10,5 P x 27 H

- 55

+ 23

- 16 - 18

921

Distributore sapone liquido (Lt.0,8) in acciaio inox
Stainless steel distributor liquid soap (Lt.0,8)
Distributif de savon liquide (Lt.0,8) en acier inox
Seifenspender (Lt.0,8) aus Edelstahl
Дозатор для мыла - 0,8 литра
cm 9 L x 8 P x 19 H

- 55



494

Distributore sapone liquido in ABS
ABS distributor liquid soap
Distributif de savon liquide en ABS
Seifenspender aus ABS
Дозатор для мыла - литр
cm 10 L x 8 P x 25 H

- 08

K 32

Distributore sapone liquido (Lt.0,17) in ABS
ABS distributor liquid soap (Lt.0,17)
Distributif de savon liquide (Lt.0,17) en ABS
Seifenspender (Lt.0,17) aus ABS
Дозатор для мыла - 0,17 литра
cm 5,5 L x 7 P x 14 H

- 08

K 22

Distributore sapone liquido (Lt.1,2)
Distributor liquid soap (Lt.1,2)
Distributif de savon liquide (Lt.1,2)
Seifenspender (Lt.1,2)
Дозатор для мыла
cm 13 L x 10 P x 23 H

- 01

K 23

Distributore carta igienica
Distributor hygienic paper
Distributif papier hygiénique
Toilettenpapierspender
Ящик для гигиенической бумаги
cm Ø 19 x 12 P

- 01

K 26

Filo stendi biancheria
Retractable clothes line
Fil étendoir
Wäscheleine
Выдвижная бельевая верёвка
cm 9 Ø x 5/200 L

- 55

K 27 INOX

Distributore sacchetti igienici INOX 304
Sanitary bags dispenser
Distributif sachets hygiénique
Hygienebeutel Spender
Дозатор для гигиенических пакетов
cm 10 L x 2,5 P x 14 H

- 55

- 23



K 25

Distributore di carta copriwater INOX 304
STAINLESS STEEL 304 toilet paper dispenser
Distributeur de papier toilette en ACIER INOXYDABLE 304
Toilettenpapierspender aus EDELSTAHL 304
дозатор туалетной бумаги STAINLESS STEEL 304
cm 22,5 L x 4,5 P x 30 H

- 55

- 23

1309

Dispenser carta igienica misto
Dispenser carta igienica misto
Distributeur carta igienica misto
Spender carta igienica misto
Диспенсер carta igienica misto
cm 14 L x 15 P x 11 H

- 55

- 23



496

Distributore carta igienica in acciaio inox 304
Stainless steel distributor hygienic paper
Distributif papier hygiénique en acier inox
Toilettenpapierspender aus Edelstahl
Ящик для бумажных полотенец
cm 31 Ø x 13 P

- 55

- 23

K 48

Distributore automatico di sapone / gel igienizzante
Automatic soap dispenser / hygiene gel
Distributeur automatique de savon / gel d'hygiène
Automatischer Seifenspender / Hygienegel
Автоматический дозатор мыла / гигиенический гель
cm 9 L x 9,5 P x 20 H • 0,5 lt

- 01

925

Distributore carta igienica misto in acciaio inox
Stainless steel distributor hygienic paper in sheets
Distributif papier hygiénique feuilles en acier inox
Toilettenpapierspender für Einzelblatt Entnahme aus Edelstahl
Ящик для бумажных полотенец в листах
cm 13 L x 11 P x 30 H

- 55

+ 23

- 16 - 18

K 45

Distributore carta igienica con doppio rotolo in acciaio INOX 304
Toilet paper dispenser with double roll in stainless steel 304
Distributeur de papier hygiénique avec double rouleau en acier inoxydable inox 304
Toilettenpapierspender mit Doppelrolle aus Edelstahl Inox 304
Дозатор туалетной бумаги с двойным рулоном из нержавеющей стали 304
cm 31 Ø x 13 P

- 55

1043

Mensola di cortesia inox
Cortesy bracket inox
Etagère
Ablage
Полка для туалетных принадлежностей
cm 10 L x 5 P x 3 H

- 55

1138

Mensola di cortesia ad angolo inox
Cortesy bracket inox
Etagère
Ablage
Полка для туалетных принадлежностей
cm 13 L x 13 P x 2,5 H

- 55

1059

Vaschetta di cortesia inox
Stovage try inox
Tablet
Tablet
Лоток для туалетных принадлежностей
cm 20 L x 12 P x 3 H

- 55



K 50

Asciugamani a lama d'aria senza resistenza
Air knife hand dryers without resistance
Air knife hand dryers without resistance
Luftmesser-Händetrockner ohne Widerstand
Сушилки для рук с воздушным ножом без сопротивления
cm 22 L x 16 P x 28 H
CE: V 220 - 240 W 1100

- 01 ABS
- 08



01 ABS

K 39

Asciugamani elettrico con fotocellula INOX 304
Towels electrical worker with photoelectric cell INOX 304
Serviettes électrique avec photocellule INOX 304
Automatischer Handtrockner INOX 304
Сушилка для рук
cm 31 L x 27 P x 25 H
CE: V 220 W 2500 IP 24

- 55



K 46

Asciugamani elettrico JET - Led con raggi UV / Resistenza elettrica disattivabile / Motore AC a 2 velocità / Attivazione automatica con sensore
Towels electrical worker with photoelectric cell Serviettes électrique avec photocellule
Automatischer Handtrockner
Сушилка для рук
cm 30 L x 22 P x 68 H
CE: V 220-240 W 1900 IP 44

- 08



K 21

Asciugamani elettrico con fotocellula
Towels electrical worker with photoelectric cell Serviettes électrique avec photocellule
Automatischer Handtrockner
Сушилка для рук
cm 18 L x 12 P x 28 H
CE: V 220 W 1500 IP 24

- 08



K 40

Asciugacapelli elettrico a parete
Wall-mounted electrical hairdryer
Sèche-cheveux électrique à mur
Elektrischer Wandhaartrockner
Электрический фен
cm 25 L x 14 P x 23,5 H
CE: V 230 W 1500 IP 24

055 PIKKOLO

Asciugacapelli elettrico a parete con avviamento a pulsante
Wall-mounted electrical hairdryer with push button starter
Sèche-cheveux électrique à mur démarrage avec bouton
Elektrischer Wandhaartrockner mit Start-Taste
Электрический фен
cm 11 L x 21 H
CE: V 220 W 1500 IP 24



056

Asciugacapelli a parete
Wall hair dryer
Sèche-cheveux à mur
Wandhaartrockner
Электрический фен
cm 14 L x 45 H
CE: V 220 W 800 IP 24
- 056.00 Con avviamento automatico
Whitautomaticstart/Avecdémarrageautomatique
Mit automatischem Start/c автоматическим стартом



K 49

Asciugacapelli elettrico a parete Inox 304 e ABS
Wall-mounted electrical hairdryer
Sèche-cheveux électrique à mur
Elektrischer Wandhaartrockner
Электрический фен стены Inox 304 и ABS
cm 22 L x 11 H x 26 H
CE: V 220 - 240 W 1300 IP 21



478.3LT

Contenitore per rifiuti inox con pedale
Stainless steel refusals container with pedal
Containeur pour refus en acier inox avec pédale
Abfalleimer aus Edelstahl mit Fußpedal
Контейнер для мусора с педалью
cm ø 17 x 25 H

- 55
- 25 - 16



25 16

HQC

478.5LT

Contenitore per rifiuti inox con pedale
Stainless steel refusals container with pedal
Containeur pour refus en acier inox avec pédale
Abfalleimer aus Edelstahl mit Fußpedal
Контейнер для мусора с педалью
cm ø 21 x 29 H

- 55
- 23
- 25 - 16



16 23 25

HQC

1310.5LT CHIUSURA SILENZIOSA

Contenitore (5lt.) per rifiuti inox con pedale
Stainless steel refusals container (5 Lt.) with pedal
Containeur (5Lt.) pour refus inox avec pédale
Abfalleimer (5Lt.) aus Edelstahl mit Fußpedal
Овальный контейнер для мусора
cm 19 L x 14,3 P x 26,5 H

- 55
- 54



55

803.3L QUADRO

Contenitore (3lt.) per rifiuti inox con pedale
Stainless steel refusals container (3 Lt.) with pedal
Containeur (3Lt.) pour refus inox avec pédale
Abfalleimer (3Lt.) aus Edelstahl mit Fußpedal
Квадратный контейнер для мусора
cm 16 L x 16 P x 24,5 H

- 55



HQC

478.12

Contenitore per rifiuti inox con pedale (12 lt)
Stainless steel refusals container with pedal (12 lt)
Containeur pour refus en acier inox avec pédale (12 lt)
Abfalleimer aus Edelstahl mit Fußpedal (12 lt)
Контейнер для мусора с педалью (12 lt)
cm ø 25 x 40 H

- 55



HQC

987

Contenitore per rifiuti inox (12 lt)
Stainless steel refusals container(12 lt)
Containeur pour refus en acier inox (12 lt)
Abfalleimer aus Edelstahl (12 lt)
Контейнер для мусора (12 lt)
cm ø 23 x 28 H

- 55



23

1165

Cesto quadrato INOX 304 con coperchio basculante (8Lt)
STAINLESS STEEL 304 square basket with tilting lid (8Lt)
Panier carré en acier inoxydable 304 avec couvercle basculant (8Lt)
Viereckiger Korb aus Edelstahl 304 mit kippbarem Deckel (8Lt)
Нержавеющая сталь 304 квадратная корзина с откидной крышкой (8 литров)
cm 19 L x 19 P x 29 H

- 55
- 23

1166

Cesto quadrato INOX 304 (8Lt)
STAINLESS STEEL 304 square basket (8Lt)
Panier carré en ACIER INOXYDABLE 304 (8Lt)
Korb aus rostfreiem Stahl 304 quadratisch (8Lt)
БЕСШВЕЙНАЯ СТАЛЬ 304 квадратная корзина (8 литров)
cm 19 L x 19 P x 29 H

- 55
- 23



23

K 41

Contenitore per rifiuti ABS (25 lt)
ABS refusals container(25 lt)
Containeur pour refus en ABS (25 lt)
Abfalleimer aus ABS (25 lt)
Контейнер для ABS (25 lt)
cm 35 L x 27 P x 48 H

- 01





K 01

Specchio basculante con vetro antinfortunistica
Adjustable mirror with accident-prevention glass
Mirror basculant avec verre anti prévention des accidents
Bewegbarer Spiegel aus Sicherheitsglas
Навесное зеркало с защитным стеклом
cm 61 L x 70 x H 7P

- 01

CORRIMANO IN ACCIAIO VERNICIATO CONFORMI ALLA NORMATIVA D.P.R. 503/96



K 01.02

Specchio con vetro antinfortunistica
Mirror with accident-prevention glass
Mirror avec verre anti prévention des accidents
Spiegel aus Sicherheitsglas
Зеркало с защитным стеклом
cm 60 L x 90 H x H 7P

- 01



K 02

Corrimano di sicurezza orizzontale
in acciaio verniciato
Horizontal emergency handle en stell-clad
Poignée de sûreté horizontale en acier inox
Bad Sicherheitsgriff aus beschichtetem Stahl
Горизонтальный поручень

- K 02.01 - cm 30

- K 02.02 - cm 40

- K 02.03 - cm 60

- K 02.04 - cm 90



K 07

Impugnatura di sostegno ribaltabile
Rotary support handle en stell-clad
Poigne de soutien tournant en acier inox
Stützklappgriff
Складная ручка + держатель для рулона
cm 10 L x 60 P x 21 H

- 01

Con dispositivo di bloccaggio in posizione verticale.
With blocking device in vertical position
Avec dispositif de blocage en position verticale
Mit Sperre in die senkrechte Position
Крепеж на клей

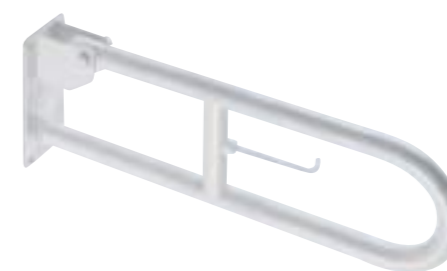

K 17

Impugnatura di sostegno ribaltabile con porta rotolo
Rotary support handle with paper holder en stell-clad
Poigne de soutien tournant avec porte roleau en acier inox
Bad Sicherheitsgriff klappbar mit Papierrollenhalter
Складная ручка + держатель для рулона
cm 10 L x 60 P x 21 H

- 01

Con dispositivo di bloccaggio in posizione verticale.
With blocking device in vertical position
Avec dispositif de blocage en position verticale
Mit Sperre in die senkrechte Position
Крепеж на клей



K 06

Impugnatura di sostegno fissa
Fixed support handle
Poigne de soutien fixe
Bad Haltestange
Поручень правосторонний
cm 16 L x 80 P x 20 H

- 01

Con rinforzo sinistro
With left reinforce/ Avec je renforce gauche
Mit Verstärkung links/ с фиксацией слева

- 01

Con rinforzo destro (come foto)
With right reinforce (same photo) / Avec renforce droite (come photo)
Mit Verstärkung rechts (wie auf dem Bild) / с фиксацией право



K 03

Corrimano di sicurezza orizzontale con 3
attacchi a parete
Horizontal emergency handle with 3 wall attacks
Poignée de sûreté horizontale avec 3 attaques à mur
Bad Sicherheitsgriff mit 3 Wandhalterungen
Перила на 3-х креплениях

- K 03.01 - cm 130

- K 03.02 - cm 150

- K 03.03 - cm 200



K 11

Corrimano verticale pavimento-parete
Vertical emergency handle floor-wall
Poignée de sûreté vertical
Wandhandlauf Boden-Wandstützgriff
Вертикальный поручень
cm 180 H

- 01



K 05

Impugnatura di sostegno da parete a pavimento
Support handle from wall to floor
Poigne de soutien de mur à plancher
Bad Haltestange Boden-Wandstützgriff
Поручень от стены к полу
cm 180 H

- 01

NYLON-ALLUMINIO



K 13

Sedile ribaltabile in nylon-alluminio con fissaggio a parete
Rotary seat in nylon-aluminium with wall fixing
Siège tournant en nylon-aluminium avec fixation à mur
Duschklappsitz aus Nylon-Aluminium für Wandmontage
Настенное сидение складное из нейлона/алюминия
cm 50 L x 35 P x 54 H

- 01



K 02 INOX

Corrimano di sicurezza orizzontale in acciaio lucido
Horizontal emergency handle en stell
Poignée de sûreté horizontale en acier inox
Bad Sicherheitsgriff aus beschichtetem Stahl
Горизонтальные поручни из полированной стали

- K 02.01.08 - cm 30

- K 02.02.08 - cm 40

- K 02.03.08 - cm 60

- K 02.04.08 - cm 90



K 04

Corrimano di sicurezza ad angolo
Corner horizontal emergency handle
Poignée de sûreté horizontale à angle
Eck-Wandhandlauf waagrecht
Угловой поручень

- K 04.02 - cm 70 x 70

- K 04.03 - cm 100 x 100



K 08

Impugnatura di sostegno a parete
Wall support handle
Poigne de soutien à mur
Winkelgriff
Поручень правосторонний угловой
cm 40 L x 70 H

- K 08 SX

- K 08 DX come foto

same photo / comme photo / wie auf dem Bild / как фото



K 17 INOX

Impugnatura di sostegno ribaltabile con porta rotolo
Rotary support handle with paper holder en stell
Poigne de soutien tournant avec porte roleau en acier inox
Bad Sicherheitsgriff klappbar mit Papierrollenhalter
Складная ручка + держатель для рулона
cm 10 L x 60 P x 21 H

- 55



K 07 INOX

Impugnatura di sostegno ribaltabile
Rotary support handle en stell-clad
Poigne de soutien tournant en acier inox
Stützklappgriff
Складная ручка
cm 10 L x 60 P x 21 H

- 55

Con dispositivo di bloccaggio in posizione verticale.
With blocking device in vertical position
Avec dispositif de blocage en position verticale
Mit Sperre in die senkrechte Position
Крепеж на клей

040

Bicchiere di ricambio
Glass spare
Verre de rechange
Ersatz Zahnputzbecher
Запасные стаканы

BIANCO
White
Blanc
Weiß

DECORATO
COLORATO
Decorated -
Coloured
Décoré - Coloré
Bemalt - Farbig



• 02
Bicchiere in ceramica per GIUNONE Ø cm 8,2
Ceramic glass for Giunone
Verre en céramique pour Giunone
Zahnputzbecher aus Keramik für Giunone



• 03
Bicchiere in ceramica per NEMI, IDRA Ø cm 7,4
Ceramic glass for Nemi, Idra
Verre en céramique pour Nemi, Idra
Zahnputzbecher aus Keramik für Nemi, Idra



• 04
Bicchiere in ceramica per SMART, FLORA Ø cm 6,0
Ceramic glass for Smart, Flora
Verre en céramique pour Smart, Flora
Zahnputzbecher aus Keramik für Smart, Flora



• 05
Bicchiere in vetro per ALFA Ø cm 5,7
Glass for Alfa
Verre pour Alfa
Zahnputzbecher aus Glas für Alfa



• 06
Bicchiere in vetro per LIZ VETRO Ø cm 5,9
Glass for Liz glass - Verre pour Liz verre -
Zahnputzbecher aus Glas für Liz



• 07
Bicchiere in ceramica per ZOE Ø cm 6,0
Ceramic glass for Zoe
Verre en céramique pour Zoe
Zahnputzbecher aus Keramik für Zoe



• 08
Bicchiere in vetro per MEDEA, DIANA Ø cm 6,2
Glass for Medea, Diana
Verre pour Medea, Diana
Zahnputzbecher aus Glas für Medea, Diana



• 09
Bicchiere in ceramica con perno per URANIA
Ceramic glass with bolt for Urania
Verre en céramique avec boulon pour Urania
Zahnputzbecher aus Keramik mit Zapfen für Urania



• 11
Bicchiere in vetro per SMART LIGHT, NOTO, MARTE Ø cm 5,9
Glass for Smart Light, Noto, Marte
Verre pour Smart Light, Noto, Marte
Zahnputzbecher aus Glas für Smart Light, Noto, Marte



• 12
Bicchiere in ceramica con perno per BUCKET, OPERA
Ceramic glass with bolt for Bucket, Opera
Verre en céramique avec boulon pour Bucket, Opera
Zahnputzbecher aus Keramik mit Zapfen für Bucket, Opera

040

Bicchiere di ricambio
Glass spare
Verre de rechange
Ersatz Zahnputzbecher
Запасные стаканы

BIANCO
White
Blanc
Weiß

DECORATO
COLORATO
Decorated -
Coloured
Décoré - Coloré
Bemalt - Farbig



• 13
Bicchiere in ceramica per MIZAR
Ceramic glass for Mizar
Verre en céramique pour Mizar
Zahnputzbecher aus Keramik für Mizar



• 14
Bicchiere in vetro con perno per SATURNO
Glass with bolt for Saturno
Verre en verre avec boulon pour Saturno
Zahnputzbecher aus Glas mit Zapfen für Saturno



• 15
Bicchiere in vetro con perno per VENUS
Glass with bolt for Venus
Verre en verre avec boulon pour Venus
Zahnputzbecher aus Glas mit Zapfen für Venus



• 16
Bicchiere in ceramica con perno per ZEFIRO
Ceramic glass with bolt for Zefiro
Verre en céramique avec boulon pour Zefiro
Zahnputzbecher aus Keramik mit Zapfen für Zefiro



• 17
Bicchiere in ceramica con perno per PRISMA
Ceramic glass with bolt for Prisma
Verre en céramique avec boulon pour Prisma
Zahnputzbecher aus Keramik mit Zapfen für Prisma



• 18
Bicchiere in vetro per ELITE Ø cm 10
Glass for Elite
Verre pour Elite
Zahnputzbecher aus Glas für Elite



• 19
Bicchiere in ceramica con perno per LIVING, GEA
Ceramic glass with bolt for Living, Gea
Verre en céramique avec boulon pour Living, Gea
Zahnputzbecher aus Keramik mit Zapfen für Living, Gea



• 20
Bicchiere in ceramica con perno per DIVA, FLUID
Ceramic glass with bolt for Diva, Fluid
Verre en céramique avec boulon pour Diva, Fluid
Zahnputzbecher aus Keramik mit Zapfen für L Diva, Fluid



• 21
Bicchiere in ceramica con perno per LIZ
Ceramic glass with bolt for Liz
Verre en céramique avec boulon pour Liz
Zahnputzbecher aus Keramik mit Zapfen für Liz

041

Porta sapone di ricambio
Soap dish spare
Porte savon de rechange
Ersatz Seifenschale
Запасные мыльницы

BIANCO
White
Blanc
Weiß

DECORATO
COLORATO
Decorated -
Coloured
Décoré - Coloré
Bemalt - Farbig



• 03
Porta sapone in ceramica per GIUNONE Ø cm 7,5
Ceramic soap dish for Giunone
Porte savon en céramique pour Giunone
Seifenschale aus Keramik für Giunone



• 04
Porta sapone in ceramica per NEMI, IDRA Ø cm 7,5
Ceramic soap dish for Nemi, Idra
Porte savon en céramique pour Nemi, Idra
Seifenschale aus Keramik für Nemi, Idra



• 05
Porta sapone in ceramica per SMART, FLORA Ø cm 6
Ceramic soap dish for Smart, Flora
Porte savon en céramique pour Smart, Flora
Seifenschale aus Keramik für Smart, Flora



• 06
Porta sapone in ceramica per OMEGA Ø cm 6,2
Ceramic soap dish for Omega
Porte savon en céramique pour Omega
Seifenschale aus Keramik für Omega



• 07
Porta sapone in vetro per ALFA, ELITE, DIANA Ø cm 6,2
Glass soap dish for Alfa, Elite, Diana
Porte savon en verre pour Alfa, Elite, Diana
Seifenschale aus Glas für Alfa, Elite, Diana



• 08
Porta sapone in vetro per LIZ VETRO Ø cm 5,9
Glass soap dish for Liz glass
Porte savon en verre pour Liz verre
Seifenschale aus Glas für Liz



• 10
Porta sapone in ceramica con perno per URANIA
Ceramic soap dish with bolt for Urania
Porte savon en céramique avec boulon pour Urania
Seifenschale aus Keramik mit Zapfen für Urania



• 12
Porta sapone in vetro per SMART LIGHT, NOTO, MARTE Ø cm 6,2
Glass soap dish for Smart Light, Noto, Marte
Porte savon en verre pour Smart Light, Noto, Marte
Seifenschale aus Glas für Smart Light, Noto, Marte



• 14
Porta sapone in ceramica per MIZAR
Ceramic soap dish for Mizar
Porte savon en céramique pour Mizar
Seifenschale aus Keramik für Mizar



• 15
Porta sapone in vetro con perno per SATURNO
Glass soap dish with bolt for Saturno
Porte savon en verre avec boulon pour Saturno
Seifenschale aus Glas mit Zapfen für Saturno

041

Porta sapone di ricambio
Soap dish spare
Porte savon de rechange
Ersatz Seifenschale
Запасные мыльницы

BIANCO
White
Blanc
Weiß

DECORATO
COLORATO
Decorated -
Coloured
Décoré - Coloré
Bemalt - Farbig



• 16
Porta sapone in ceramica con perno per ZEFIRO
Ceramic soap dish with bolt for Zefiro
Porte savon en céramique avec boulon pour Zefiro
Seifenschale aus Keramik mit Zapfen für Zefiro



• 17
Porta sapone in ceramica con perno per PRISMA
Ceramic soap dish with bolt for Prisma
Porte savon en céramique avec boulon pour Prisma
Seifenschale aus Keramik mit Zapfen für Prisma



• 19
Porta sapone in ceramica con perno per GEA
Ceramic soap dish with bolt for Gea
Porte savon en céramique avec boulon pour Gea
Seifenschale aus Keramik mit Zapfen für Gea



• 20
Porta sapone in ceramica con perno per DIVA, FLUID
Ceramic soap dish with bolt for Diva, Fluid
Porte savon en céramique avec boulon pour Diva, Fluid
Seifenschale aus Keramik mit Zapfen für Diva, Fluid



• 21
Porta sapone in ceramica con perno per BUCKET, OPERA
Ceramic soap dish with bolt for Bucket, Opera
Porte savon en céramique avec boulon pour Bucket, Opera
Seifenschale aus Keramik mit Zapfen für Bucket, Opera



• 22
Porta sapone in ceramica con perno per LIZ
Ceramic soap dish with bolt for Liz
Porte savon en céramique avec boulon pour Liz
Seifenschale aus Keramik mit Zapfen für Liz

037

Dosatore sapone liquido di ricambio
Liquid soap dispenser spare
Doseur de savon liquid de rechange
Ersatz Seifenspender
Запасные дозаторы

BIANCO
White
Blanc
Weiß

COLORATO
Coloured
Coloré
Farbig

037

Dosatore sapone liquido di ricambio
Liquid soap dispenser spare
Doseur de savon liquid de rechange
Ersatz Seifenspender
Запасные дозаторы

BIANCO
White
Blanc
Weiß

COLORATO
Coloured
Coloré
Farbig

042

Tazza per scopino di ricambio
Container for toilet-brush
Containeur pour balayent
Ersatz Behälter für Bürstengarnitur
Запасная колба от ерша

BIANCO
White
Blanc
Weiß

DECORATO
Decorated
Décoré
Bemalt

042

Tazza per scopino di ricambio
Container for toilet-brush
Containeur pour balayent
Ersatz Behälter für Bürstengarnitur
Запасная колба от ерша

BIANCO
White
Blanc
Weiß

DECORATO
Decorated
Décoré
Bemalt



• 01
Dosatore in vetro per ELITE, LIZ VETRO Ø cm 6,0
Glass dispenser for Elite, Liz glass
Doseur en verre pour Elite, Liz
Seifenspender aus Glas für Elite, Liz



• 16
Dosatore in vetro per SMART LIGHT, NOTO, MARTE Ø cm 6,2
Glass dispenser for Smart Light, Noto, Marte
Doseur en verre pour Smart Light, Noto, Marte
Seifenspender aus Glas für Smart Light, Noto, Marte



• 02
Tazza in ceramica per: G 12/i 20/i 21 Ø cm 8,3x H22
Ceramic container for: G 12/i 20/i 21
Containeur en céramique pour: G 12/i 20/i 21,
Behälter aus Keramik für: G 12/i 20/i 21



• 17
Tazza in ceramica per DIVA, FLUID
Ceramic container for Diva, Fluid
Containeur en céramique pour Diva, Fluid
Behälter aus Keramik für Diva, Fluid



• 03
Dosatore in vetro per DIANA Ø cm 6,2
Glass dispenser for Diana
Doseur en verre pour Diana
Seifenspender aus Glas für Diana



• 17
Dosatore in ceramica per LIZ
Ceramic dispenser for Liz
Doseur en céramique pour Liz
Seifenspender aus Keramik für Liz



• 03
Tazza in ceramica per: G 12a/1 12a (foto)
Ceramic container for: G 12a/1 12a
Containeur en céramique pour: G 12a/1 12a
Behälter aus Keramik für: G 12a/1 12a



• 039F2
Tazza in PVC Ø 7cm
PVC container Ø 7cm
Containeur en PVC Ø 7cm
Behälter aus PVC Ø 7cm



• 04
Dosatore in ceramica per SMART Ø cm 6,0
Ceramic dispenser for Smart
Doseur en céramique pour Smart
Seifenspender aus Keramik für Smart



• 18
Dosatore in ceramica per DIVA
Ceramic dispenser for Diva
Doseur en céramique pour Diva
Seifenspender aus Keramik für Diva



• 04
Tazza in ceramica per GABRY 186
Ceramic container for Gabry 186
Containeur en céramique pour Gabry 186
Behälter aus Keramik für Gabry 186



• CER 1200
Tazza in ceramica per Switch
Ceramic container for Switch
Containeur en céramique pour Switch
Behälter aus Keramik für Switch



• 06
Dosatore in ceramica con perno per URANIA
Ceramic dispenser with bolt for Urania
Doseur en céramique avec boulon pour Urania
Seifenspender aus Keramik mit Zapfen für Urania



• 07
Dosatore in vetro con perno per VENUS Ø cm 6,0
Glass dispenser with bolt for Venus
Doseur en verre avec boulon pour Venus
Seifenspender aus Glas mit Zapfen für Venus



• 10
Dosatore in ceramica con perno per BUCKET, OPERA Ø cm 7,0
Ceramic dispenser with bolt for Bucket, Opera
Doseur en céramique avec boulon pour Bucket, Opera
Seifenspender aus Keramik mit Zapfen für Bucket, Opera



• 11
Dosatore in ceramica per MIZAR Ø cm 6,2
Ceramic dispenser for Mizar
Doseur en céramique pour Mizar
Seifenspender aus Keramik für Mizar



• 12
Dosatore in ceramica con perno per ZEFIRO Ø cm 6,0
Ceramic dispenser with bolt for Zefiro
Doseur en céramique avec boulon pour Zefiro
Seifenspender aus Keramik mit Zapfen für Zefiro



• 13
Dosatore in ceramica con perno per PRISMA
Ceramic dispenser with bolt for Prisma
Doseur en céramique avec boulon pour Prisma
Seifenspender aus Keramik mit Zapfen für Prisma



• 14
Dosatore in vetro con perno per SATURNO
Glass dispenser with bolt for Saturno
Doseur en verre avec boulon pour Saturno
Seifenspender aus Glas mit Zapfen für Saturno



• 15
Dosatore in ceramica con perno per LIVING
Ceramic dispenser with bolt for Living
Doseur en céramique avec boulon pour Living
Seifenspender aus Keramik mit Zapfen für Living



• PA
Pompetta per dosatore (cromo)
Dispenser pump's (chrome)
Pompe pour doseur (chromé)
Pumpe für Seifenspender (Chrom)



• PB
Pompetta per dosatore (oro)
Dispenser pump's (gold)
Pompe pour doseur (or)
Pumpe für Seifenspender (Gold)



• PQ
Pompetta per dosatore
Dispenser pump's
Pompe pour doseur
Pumpe für Seifenspender



• PL
Pompetta per dosatore
Dispenser pump's
Pompe pour doseur
Pumpe für Seifenspender



• 09
Tazza in ceramica per BUCKET
Ceramic container for Bucket
Containeur en céramique pour Bucket
Behälter aus Keramik für Bucket



• 11
Tazza in ceramica per URANIA
Ceramic container for Urania
Containeur en céramique pour Urania
Behälter aus Keramik für Urania



• 12
Tazza in ceramica per ZEFIRO
Ceramic container for Zefiro
Containeur en céramique pour Zefiro
Behälter aus Keramik für Zefiro



• 13
Tazza in ceramica per COSI'
Ceramic container for Così
Containeur en céramique pour Così
Behälter aus Keramik für Così



• 14
Tazza in ceramica per LIVING, GEA
Ceramic container for Living, Gea
Containeur en céramique pour Living, Gea
Behälter aus Keramik für Living, Gea



• 15
Tazza in ceramica per ARIA
Ceramic container for Aria
Containeur en céramique pour Aria
Behälter aus Keramik für Aria



• 16
Tazza in ceramica per 972, ME 972
Ceramic container for 972, ME972 - Containeur en céramiq-
ue pour 972, ME972 - Behälter aus Keramik für 972, ME972

<p>095</p> <p>Base di ricambio Spare Base Base de rechange Ersatz Fußplatte Запасная основа</p>	<p>CROMO Chrome Chrome Chrom</p>	<p>ORO-BRONZO Gold-Bronze Or-Bronze Gold-Bronze</p>	<p>• 095.01 Base in ottone senza peso per piantane ø 25cm Brass base without weight for stands ø 25cm Base en laiton sans poids pour montants ø 25cm Fußplatte aus Messing ohne Beschwerung für Ständer ø 25 cm</p>	
				<p>• 095.02 Base in ottone con peso per piantane Di 19 / U 19 Brass base with weight for Di 19 / U 19 Base en laiton pour montants pour Di 19 / U 19 Fußplatte aus Messing mit Beschwerung für Ständer Di 19 / U 19</p>
				<p>• 01 Base in ottone per piantane senza peso ø 20cm Brass base without weight ø 20cm Base en laiton pour montants sans poids ø 20cm Fußplatte aus Messing ohne Beschwerung für Ständer ø 20cm</p>
<p>091</p> <p>Finale di ricambio End-knob Final de rechange Ersatz Endteil Запасная насадка</p>	<p>LEGNO OTTONE Wood-brass Bois-laïton Holz-Messing</p>	<p>VETRO CERAMICA BIANCA White glass-ceramic Verre-céramique Weiß Glas-Keramik</p>	<p>DECORATO Decorated Décoré Bemalt</p>	
				<p>• 01 Finale per NEMI End-knob for Nemi Endteil für Nemi</p>
				<p>• 02 Finale per ALFA End-knob for Alfa Endteil für Alfa</p>
<p>• 06 Finale per SMART LIGHT End-knob for Smart Light Endteil für Smart Light</p>				

<p>050</p> <p>Manico con ciuffo di ricambio Handle with brush Poignée avec touffe Griff und Ersatzbürstenkopf Запасная щетка от ерша</p>	<p>CROMO BIANCO White-Chrome Blanc-Chromé Weiß-Chrom</p>	<p>ORO-BRONZO Gold-Bronze Or-Bronze Gold-Bronze</p>	<p>• 050.01 Manico per Gabry Handle for Gabry Poignée pour Gabry Griff für Gabry</p>	
				<p>• 050.02 Manico con ciuffo in PVC Handle with PVC brush Poignée avec touffe en PVC Griff und Bürstenkopf aus Kunststoff (PVC)</p>
				<p>• 050.03 Manico + ciuffo in setola + coperchio per scopino Handle + bristle brush + cover toilet-brush Poignée + touffe en brin + couvercle pour balayent Griff + Bürstenkopf mit Borsten + Deckel</p>
<p>• 050.04 Coperchio in ottone per scopino ø cm 8 Brass cover for toilet-brush Couvercle en laiton pour balayent Deckel aus Messing für Bürstengarnitur</p>				
<p>103</p> <p>Manico con ciuffo di ricambio Handle with brush Poignée avec touffe Griff und Ersatzbürstenkopf Запасная щетка от ерша</p>	<p>CROMO BIANCO White-Chrome Blanc-Chromé Weiß-Chrom</p>	<p>ORO-BRONZO Gold-Bronze Or-Bronze Gold-Bronze</p>	<p>• 103 Gambo con ciuffo in setola cm 14 ø 55 Stem with bristle brush cm 14 ø 55 Tige avec touffe en brin cm 14 ø 55 Stielbürste und Bürstenkopf, Borsten cm 14 ø 55</p>	
				<p>• 103.NE Nero / Black / Noir / Swarz / Чорн Gambo con ciuffo in setola cm 14 Stem with bristle brush cm 14 Tige avec touffe en brin cm 14 Stielbürste und Bürstenkopf, Borsten cm 14</p>
				<p>• 103.65 Gambo con ciuffo in setola cm 14 x ø 65 Stem with bristle brush cm 14 x ø 65 Tige avec touffe en brin cm 14 x ø 65 Stielbürste und Bürstenkopf, Borsten cm 14 x ø 65</p>
<p>• 103.COSÌ Gambo con ciuffo in setola cm 10 x ø 55 Stem with bristle brush cm 10 x ø 55 Tige avec touffe en brin cm 10 x ø 55 Stielbürste und Bürstenkopf, Borsten cm 10 x ø 55</p>				
<p>• 103.IN Gambo con ciuffo in setola cm 3,5 x ø 65 Stem with bristle brush cm 3,5 x ø 65 Tige avec touffe en brin cm 3,5 x ø 65 Stielbürste und Bürstenkopf, Borsten cm 3,5 x ø 65</p>				
<p>• 103.IN 55 Gambo con ciuffo in setola cm 3,5 x ø 55 per 1946 Stem with bristle brush cm 3,5 x ø 55 for 1946 Tige avec touffe en brin cm 3,5 x ø 55 pour 1946 Stielbürste und Bürstenkopf, Borsten cm 3,5 x ø 55 für 1946</p>				
<p>VET</p> <p>Paralumi di ricambio Spare lampshades Abat-jour de rechange Ersatz Lampenläser абажуром замена</p>	<p>BIANCO White Blanc Weiß</p>	<p>DECORATO COLORATO Decorated - Coloured Décoré - Coloré Bemalt - Farbig</p>	<p>• VET N 17 Vetro per N 17 Glass for N 17 Verre pour N 17 Lampenglas für N 17</p>	
				<p>• VET 692 Vetro per 692 Glass for 692 Verre pour 692 Lampenglas für 692</p>
				<p>• VET CA 17 Vetro per CA 17 Glass for CA 17 Verre pour CA 17 Lampenglas für CA 17</p>
<p>• VET 774 Vetro Pyrex per 774 Glass Pyrex for 774 Verre Pyrex pour 774 Pyrex Glas für 774</p>				
<p>• LAMP9LED LED 69 30W 3000K 250 Lumen Lampada Bulb Ampoule Lamp</p>				
<p>• TRASF Trasformatore 15 W transformer 15 W transformateur 15 W transformator 15 W</p>				
<p>• TRASF 2 Trasformatore 20 W transformer 20 W transformateur 20 W transformator 20 W</p>				
<p>• TRASF 8 Trasformatore 30 W transformer 30 W transformateur 30 W transformator 30 W</p>				
<p>• TRASF 12 Trasformatore 60 W transformer 60 W transformateur 60 W transformator 60 W</p>				

ESPOSITORI

EXHIBITORS / EXPOSANTS / AUSSTELLUNGSSTÄNDER / НАПОЛЬНЫЙ



EXPO 17

Pannello espositore con presentazione fotografica
 Displayboard with picture
 Présentoir avec photo
 Ausstellungspaneel mit Fotopräsentation
 Выставочная панель с презентацией фотографий
 cm 60 L x 20 H



EXPO9

EXPO1

EXPO 9

Espositore per oggettistica con anta in vetro e serratura
 Display board for freestanding articles with glass door and lock
 Présentoir pour objets à poser avec guichet en verre et fermeture
 Ausstellungsständer für Zubehör mit Glastür und Schloss
 Напольный стенд с замком для настольных предметов
 cm 29 L x 20 P x 160 H

EXPO 1

Pannello espositore su ruote
 Display board on wheels
 Présentoir sur des roues
 Ausstellungsstand auf Rollen
 Напольный стенд на колесах
 cm 60 L x 42 P x 210 H

CONDIZIONI DI VENDITA

ACCETTAZIONE DELL'ORDINE E VALIDITÀ - Ogni ordine, variazione o annullamento devono pervenire per iscritto al nostro ufficio vendite, tramite cliente o Agenti. Gli ordini incompleti o privi di informazioni che non ne permettono una corretta esecuzione, possono subire ritardi di registrazione. Ogni ordine superiore a €750,00 + IVA, sarà valido se accettato con conferma d'ordine. In caso di annullamento ordine SPECIALE già eseguito ci riserviamo di addebitare il 50% del costo dello stesso. Le Condizioni Generali di Vendita si applicano a tutti i rapporti con i Clienti e s'intendono tacitamente accettate senza rinnovo ad ogni singolo ordinativo.

TEMPI DI CONSEGNA - I tempi di consegna sono espressi in giorni lavorativi e devono intendersi meramente indicativi; eventuali ritardi di consegna non danno diritto alla risoluzione del contratto, tanto meno ad indennizzi o risarcimenti di sorta. Gli ordini possono essere evasi anche parzialmente.

CONTROLLO DEL MATERIALE - RESI - La merce viaggia a rischio e pericolo del committente ai sensi dell'art. 1510 del codice civile; eventuali danni direttamente al vettore anche quando la merce è recapitata in porto franco e comunque inviare entro 24 ore dal ricevimento un email all'Azienda, indicando i riferimenti della fattura, articolo, quantità, motivazione ed eventuali immagini dell'insieme e del particolare contestato. Non si accettano resi di merce se non espressamente autorizzati per iscritto e comunque franchi di ogni spesa al magazzino della nostra sede. I resi causati da errori di trasmissione dell'ordine da parte del cliente verranno accreditati all'80% del prezzo netto di vendita. Per resi autorizzati, utilizzare l'imballo originale. Non si accettano richieste di resi di articoli speciali o articoli fuori produzione, pur rimanendo disponibili ad eventuali valutazioni che dovessero necessitare. Non si accettano richieste di resi per difetti visibili o di natura estetica, di materiali già installati. Il mancato rispetto di quanto sopra può provocare l'immediato decadimento della garanzia.

TOLLERANZE - Le illustrazioni dei nostri prodotti, deplianti e cataloghi, non costituiscono impegno di fedele riproduzione, la ditta si riserva il diritto di apportare modifiche ai propri prodotti senza l'obbligo di preavviso.

CONDIZIONI DI PAGAMENTO - Il mancato rispetto dei termini di pagamento, comporta l'addebito degli interessi al tasso prime-rate ABI maggiorato di 3 punti a far data dall'emissione della fattura + € 15,00 per recupero spese. E' facoltà della ditta sospendere le consegne di clienti inadempienti. L'azienda si riserva la proprietà delle merci non ancora pagate.

CONTRASSEGNO - Le spedizioni di importo totale inferiore a € 150,00 saranno effettuate in contrassegno o bonifico anticipato.

TRASPORTI - Il trasporto è franco per importi di imponible superiore ad e 250,00, in caso contrario si provvederà al recupero in fattura di € 15,00. Per ISOLE:

- Per importi di imponible inferiore ad € 500.00 il contributo per il trasporto è pari ad € 18,00;
- per importi superiori a € 700,00 il trasporto è franco.

IMBALLI - Per spedizioni di materiali con pallet si provvederà al recupero in fattura di € 10,00.

IMBALLI PER SPEDIZIONI SPECCHI - Per spedizioni si provvederà al recupero in fattura di: € 5,00 netti a specchio per misure fino cm150, € 10,00 netti a specchio per misure superiori cm 150

FORNITURE - Per forniture personalizzate e grandi volumi le condizioni di vendita e di trasporto verranno stabilite su preventivo.

LE PRESENTI CONDIZIONI DI VENDITA SI INTENDONO ACCETTATE CON L'ORDINE

CONDIZIONI VALIDE SOLO PER IL MERCATO ITALIANO

RAEE - Iscr. Al Registro A.E.E. n. IT 3110000008191, i prezzi delle illuminazioni non comprendono il contributo.

PRIVACY - Ai sensi della legge DL 196/2003 e del regolamento (UE) n. 2016/679 (GDPR), Stilhaus Arredo Bagno srl dichiara che i dati messi a disposizione dal committente verranno elaborati nel rispetto della legge sulla tutela della privacy.

Terms of sale FOR EXPORT/ Conditions de vente POUR L'EXPORTATION
Verkaufsbedingungen GILT FÜR AUSLÄNDISCHE / условия ПРОДАЖИ

ORDERS - All orders must be accepted by STILHAUS srl, no order can be cancelled without the written consent of the STILHAUS srl. Cancelled orders are subject to payment cancellation charges to cover all costs incurred by the company up to date of cancellation. Orders can be delivered partially too.
PRICES - The price-list does not include VAT, and prices can change whitout notice. All goods are sold ex works STILHAUS's factory.

DELIVERY - The delivery time starts from the date of the order-confirmation. The goods travel at buyer's risk even if sold free of carriage, the consignee must check the goods on their arrival and claim immediately eventual damages directly to the carrier who is the responsible. Any complaint must be presented in written form within 24 hours from receipt of the goods: otherwise STILHAUS SRL will not acknowledge any compensation for damages or assessed breakages.

RAE - Iscr. Register to A.E.E. n. 3110000008191 IT, prices do not include the contribution of the illuminations

PAYMENT TERMS - Payments must be done according to the terms agreed upon and indicated on our order confirmation; in case of delayed payments STILHAUS reserves itself the right to debit the purchaser with the applicable interests. The supplied products remain property of STILHAUS srl up to complete payment of the price.

RETURNS - Returned goods are not accepted if not agreed previously with STILHAUS by written authorization. Damage caused by an improper installation or wrong use are not covered by any guarantee.

LAW COURT - For any controversy the Court of Viterbo is the only competent authority.

In order to improve its products, STILHAUS reserves itself the right to modify the technical data, aesthetic and dimensional peculiarities without notice.

ALL THE ABOVE MENTIONED CONDITIONS ARE CONSIDERED AS FULLY ACCEPTED WHEN PLACING THE ORDER

COMMANDES - Toutes les commandes sont sujettes à l'approbation de STILHAUS srl. Aucune commande ne peut être annulée sans préalable approbation de STILHAUS srl, qui se réserve en tous cas le droit de débiter éventuels coûts soutenus jusqu'à la date de l'annulation. Les commandes peuvent être livrées partiellement.

PRIX - Nos marchandises sont facturées sur la base des tarifs en vigueur au jour de la livraison et peuvent varier sans précision. Le tarif ne comprend pas de TVA et la marchandise est vendue départ usine STILHAUS.

LIVRAISON - Le délai de livraison commencent à partir de la date de confirmation de l'a commande etsont toujours indicatifs. Le transfert du risque s'effectue vers l'acheteur au moment de l'expédition, même en cas de livraison franco. Le destinataire est obligé de vérifier les marchandises arrivées et de réclamer les éventuels dommages immédiatement directement au transporteur qui en est le responsable. En ce qui concerne la conformité, la quantité et la qualité apparente de la marchandise livrée par rapport à celle commandée, l'acheteur doit nous adresser ses réclamations éventuelles par écrit au plus tard dans un délai de 24 HEUERES après réception. Au delà les réclamations ne sont plus recevables.

RAEE - Iscr. Inscrivez-vous pour A.E.E. n. 3110000008191 IT, prix ne comprennent pas la contribution des illuminations

PAIEMENT - Les termes de paiement ne peuvent pas être retardés pour quelque cause que ce soit, même en cas de litige. Dans le cas de paiement retardé STILHAUS se réserve ledroit de débiter à l'acheteur les intérêts applicables. Les produits fournis restent propriété de STILHAUS srl jusqu'au paiement complet du prix.

GARANTIE - Notre garantie couvre tous défauts de fabrication à condition que notre produit ait été installé conformément à nos instructions de montage et aux règles de l'art. Notre garantie est limitée à la remise en état ou remplacement de la pièce reconnue défectueuse. La garantie ne couvre, en aucun cas, les frets de main d'oeuvre, des frais de déplacement, choc, utilisation de produits de nettoyage corrosifs ou abrasifs.

RETOURS - Aucun retour de marchandise ne peut-être effectué sans notre accord écrit.

CARACTÉRISTIQUES DU PRODUIT - Pour améliorer ses produits, STILHAUS se réserve le droit de modifier les données techniques, esthétique caractéristiques et dimensionnels sans avis.



CONTESTATIONS - En cas de contestation, le Tribunal de Viterbo est la seule juridiction reconnue et acceptée de part et d'autre.

TOUTES LES CONDITIONS SURMENTIONNÉES SONT CONSIDÉRÉES COMPLÈTEMENT ACCEPTÉES EN PASSANT LA COMMANDE

AUFTRÄGE - Alle Aufträge müssen von der STILHAUS srl bestätigt werden. Kein Auftrag kann ohne die schriftliche Zustimmung von STILHAUS srl annulliert werden. Die Kosten der Annullierung des Auftrags müssen vom Kunden getragen werden. Die Aufträge können partiell verändert werden.

PREISE - Die Preise beinhalten nicht die Mehrwertsteuer und können ohne Vorankündigung verändert werden. Alle Waren werden frei Fabrikhallen bereitgestellt.

LIEFERBESTIMMUNGEN - Die Lieferzeit beginnt mit dem Datum der Auftragsbestätigung. Die Waren werden nach Auftrag und zu Lasten des Käufers versandt. Der Käufer muss die Waren bei der Ankunft kontrollieren und eventuelle Schäden unverzüglich der betrauten Spedition melden. Was die Auftragskonformität, Qualität und Menge der gelieferten Waren betrifft, so muß der Käufer eventuelle Unstimmigkeiten innerhalb von 24 Stunden nach der Lieferung melden. Außerhalb der Fristen werden Reklamationen nicht akzeptiert.

RAEE - Iscr. Registrieren A.E.E. n. 3110000008191 IT, Preise enthalten keine Leuchtmittel

ZAHLUNGSMODALITÄTEN - Die Zahlung muss nach den Bestimmungen erfolgen die auf der Auftragsbestätigung vereinbart wurden. Im Falle einer verspäteten Zahlung, behält sich Stilhaus das Recht vor dem Käufer die Zinsen in Rechnung zu stellen. Die gelieferten Waren bleiben bis zur vollständigen Bezahlung Eigentum von STILHAUS srl.

RÜCKGABE - Durch nicht sachgemäße Installation und Gebrauch verursachte Schäden werden nicht von der Garantie gedeckt.

BESCHWERDE - Beschwerde- Gerichtsort ist Viterbo.

TOLLERANZEN - Mit dem Ziel die Produkte zu verbessern, behält sich Stilhaus vor, Veränderungen an den eigenen Produkten ohne Vorankündigung durchzuführen.

ALLE OBEN GENANNTEN BEDINGUNGEN GELTEN MIT DER ANNAHME DES AUFTRAGS ALS ANGENOMMEN

Заказы – все заказы должны быть приняты фабрикой Stil Haus, заказ не может быть аннулирован без письменного оповещения фабрикой. Отмененные заказы подлежат возврату денежных средств. Заказы также могут быть доставлены частично.

Цены – Прайс-лист не включает НДС, и цены в счете могут быть другими. Все товары вывозятся с фабрики самостоятельно.

Поставки – Срок поставки начинается с момента подтверждения заказа. Все риски ложатся на покупателя. Все претензии рассматриваются в письменной форме в течении 24 часов после получения товара. В противном случае фабрика Stil Haus не несет ответственности за возмещение поврежденного груза.

RAEE - ISCR. Зарегистрируйтесь, чтобы A.E.E. n. 3110000008191 IT, Цены не включают вклад иллюминации

Условия оплаты – оплата может быть произведена в соответствии с выставленным счетом. В случае задержки оплаты, фабрика оставляет за собой право не отгружать неоплаченный товар до момента погашения полной стоимости товара.

Возврат товара – Возврат товара не принимается если он не был согласован ранее письменно с фабрикой.

Гарантия не распространяется при неправильной установке, при неправильном использовании.

Единственным органом – способным разрешить спорные ситуации, является суд Витербо. С целью улучшения продуктов STILHAUS оставляет за собой право изменять технические характеристики, габариты и внешний вид изделий без предварительного уведомления.

ВСЕМИ ВЫШЕПЕРЕЧИСЛЕННЫМИ УСЛОВИЯМИ СЧИТАЮТСЯ КОГДА ВЫ СОГЛАСНЫ ПОДТВЕРДИТЬ ЗАКАЗ.

TABELLA COLORI

COLOUR CHART / TABLEAU COULEURS / FARBENTABELLE / ДИАГРАММА ЦВЕТА



La cromatura viene effettuata su particolari che vengono sottoposti ai seguenti trattamenti:
Pulimentatura, sgrassatura chimica con ultrasuoni, sgrassatura elettrolitica, nichelatura lucida livellante con uno spessore medio di 18-20 micron; cromatura con spessore medio di 0,3 micron.
Cromature conformi ai test di salinità secondo la norma UNI ISO 9227 NSS.
La doratura viene eseguita con oro 24 karati con spessore medio di 0,04 micron e verniciatura trasparente con cottura a forno a 180°C.
La verniciatura antico toscano viene effettuata su particolari che vengono sottoposti ai seguenti trattamenti:
Sabbatura, due mani di fondo, decorazione a mano, e verniciatura trasparente con cottura a forno a 180 °C.

The chrome-plating is effected on component that are treated with the following processes:
Polishing, chemical ultrasonic cleaning, electrolytic degreasing, shiny nickel-plating with a average thickness of 18-20 microns; chromium plating with average thickness of 0,3 microns.
Salinity test UNI ISO 9227 NSS is carried out.
The gilding is performed with gold 24 karats with average thickness of 0,04 microns coated by a transparent painting in oven cooking at 180°C.
The ancient Tuscan painting is made on parts that are treated with the following processes: sand bath, two ground coats, hand decoration and transparent painting in oven cooking at 180°C.

Le chromage est effectué sur des parties qui subissent les suivants traitements:
Polissage, dégraissage chimique par Ultrasons, dégraissage électrolytique, nickelage Brillant avec une épaisseur moyenne de 18-20 Microns; chromage avec épaisseur moyenne de 0,3 microns. Test de salinité UNI ISO 9227 NSS effectué. La dorure est réalisée en or 24 Carates avec épaisseur moyenne de 0,04 microns et couverte par une peinture transparente cuite au four à 180°C.
La peinture ancien toscano est réalisée sur des parties qui sont soumises aux suivants

traitements: sablage, deux mains de fond, décoration à la main couverte par une peinture transparente cuite au four à 180°C.
Die Verchromungen werden auf Einzelteilen angebracht die folgenden Verfahren unterzogen werden: Säuberung, chemische Entfettung mit Ultraschall, elektrolytische Entfettung, Vernickelung mit einer Stärke von ca. 18-20 Mikron. Verchromung mit einer Stärke von ca. 0.3 Mikron. Verchromung entspricht der Norm UNI ISO 9227 NSS.
Die Vergoldung wird mit 24 karätigem Gold in einer durchschnittlichen Stärke von 0,04 Mikron ausgeführt und mit einer transparenten Beschichtung bei 180 grad im Ofen gebrannt.
Die Farbe "Toskanisches Antik" wird auf Einzelteilen angebracht die folgenden Verfahren unterzogen werden: Sandstrahlung, 2 Lagen Grundierung, Verzierung per Hand und transparente Beschichtung bei 180 Grad im Ofen gebrannt.

Хромирование осуществляется на детали, которые проходят следующие процедуры: Полировка, обезжиривание и технология ультразвуковой очистки, глянцевое никелирование средней толщиной 18-20 мкм, хромирование толщиной в 0,3 мкм. Хромирование используется в соответствии со стандартом UNI ISO 9227 NSS
Золочение осуществляется 24 каратами средней толщиной 0,04 мкм и прозрачным покрытием при температуре 180° с. Тосканская живопись производится при следующих условиях: Пескоструйная обработка, два слоя грунтовки, ручная отделка, и прозрачным покрытием при температуре 180° с

FINITURE DISPONIBILI / AVAILABLE FINISHINGS / FINISSAGES DISPONIBLES / VERFÜGBARE OBERFLÄCHEN / ВАРИАНТЫ ОТДЕЛОК

02 CROMO - ORO / Chrome - Gold / Chrome - Or / Chrom - Gold / Хром - золото
ELITE / GIUNONE / SMART / BACKET

03 BIANCO - CROMO / White - Chrome / Blanche - Chrome / Weiß - Chrom / Белый - хром
GIUNONE / LIVING / BACKET / TOTEM

04 BIANCO - ORO / White - Gold / Blanche - Or / Weiß - Gold / Белый - золото
GIUNONE

05 NERO - CROMO / Blac - Chrome / Noir - Chrome / SwarZChrom / черный - Хром
LIVING / BACKET / TOTEM

CROMO / Chrome / Chrome / Chrom / Хром
08 ARIA / URANIA / DIANA / MEDEA / GEA / LIVING / BUCKET / DIVA / MARTE / PRISMA / SMART / SMART LIGHT / ELITE / GIUNONE / IDRA / NEMI / MARTE / MIZAR / OPERA / RAIL / REGAL / TOTEM / EQUILIBRIUM

09* OTTONE NATURALE / Natural Brass / Laiton naturel / Natürliches Messing / Натуральная латунь
RAIL / MEDEA / ELITE / URANIA / HASHI

10* OTTONE LUCIDO / Polished brass / Laiton poli / Poliertes Messing / Полированная латунь
RAIL / MEDEA

12 NICHEL LUCIDO / Polish nikel / Nikel poli / Nikel poliert / Глянцевый никель
IDRA

14* ORO CHIARO / Light gold / Or clair / Helles Gold / Светлое золото
MEDEA / HASHI / URANIA / ELITE / RAIL

15* ORO SATINATO / Satin gold / Or satiné / Satiniertes Gold / Сатиновое золото
MEDEA / HASHI / URANIA / ELITE / RAIL

16 ORO / Gold / Or / Gold / Золото
ELITE / GIUNONE / SMART LIGHT / MARTE / MEDEA / PRISMA / REGAL

17 ORO ROSA / Rose gold / L'or rose / Roségold / розовое золото
HASHI / OPERA / EQUILIBRIUM

18 ORO OPACO / Matt gold / Or mat / Mattes Gold / матовое золото
GEA / HASHI / MEDEA / REGAL / EQUILIBRIUM

19* ORO INGLESE / English gold / Or anglais / Englisches Gold / Английское золото
MEDEA / HASHI / URANIA / ELITE / RAIL

20 CROMO-ORO OPACO / Chrome-matt gold / Chrome-or mat / Chrom-mattes Gold / хром-матовое золото
BACKET

23 NERO OPACO / Black Matt/ Nour / Scharz / черный матовый
URANIA / KREA / HASHI / MEDEA / BACKET / RAIL / EQUILIBRIUM

24 BIANCO OPACO / White Matt/ Blanc opaque / Weiße / белый матовый
HASHI / BACKET / MEDEA

25 BRONZO / Bronze / Bronze / Bronze / Бронза
PRISMA / ELITE / GIUNONE / SMART / SMART LIGHT / IDRA / MARTE / REGAL

26 RAME / Copper / Cuivre / Kupfer / Медь
ELITE / GIUNONE / IDRA

27 BRONZO OPACO / Matt bronze / Bronze mat / Matte Bronze / матовая бронза
ELITE

28* BRONZO SCURO OPACO / Dark matt bronze / Bronze foncé mat / Dunkelbronze matt / Темная бронза матовая
MEDEA / HASHI / URANIA / ELITE / RAIL

33 CROMO - LEGNO NOCE / Chrome - Dark walnut wood / Chrome - bois noiser / Chrom - Nußb-
raun dunkel / белый - дерево орех
NEMI

36 NICHEL SATINATO / Satin nickel / Nickel satiné / Nickel matt / Никель сатин
URANIA / MEDEA / ELITE / GIUNONE / PRISMA / RAIL / MARTE / HASHI / EQUILIBRIUM

NICKEL SATINATO OPACO / Matt satin nickel / Nickel satiné mat / Nickel matt satinier /
Матовый сатиновый никель
37* RAIL / MEDEA / ELITE / URANIA / HASHI

CROMO - CERAMICA BIANCA / Chrome - white pottery / Chromé blanche céramique / Chrom Weiße
Keramik / хром - белая керамика
39 NEMI

CROMO - CERAMICA DECORATA / Chrome - decorated pottery / Chromé - médaillée céramique
/ Chrom - dekorierte Keramik / хром - керамика декорированная
40 NEMI

54 ACCIAIO SATINATO / Satin steel / Acier satiné / Stahl satinier / сатинованная сталь
SATURNO / KREA

55 ACCIAIO LUCIDO / Satin steel / Acier satiné / Stahl satinier / Полированная сталь
HOTELLERIE

56 NICHEL NERO LUCIDO / Glossy black nickel / Nickel noir brillant / Glänzend schwarzes Nickel /
Глянцевый черный никель
HASHI

57 NICHEL NERO SATINATO / Satin black nickel / Nickel noir satiné / Satiniertes schwarzes Nickel /
атласный чёрный никель
GEA

58 CROMO-NIKEL SATINATO / Chrome - Glossy Black Nickel / Chrome - Nickel noir brillant /
Chrom - Glänzendes Schwarz-Nickel / Хром - глянцевый черный никель
BACKET

59 NERO OPACO + ORO OPACO / Matt black + matt gold / Noir mat + or mat / Mattschwarz +
Mattgold / матовое черное + матовое золото
BACKET

60 CROMO-NIKEL SATINATO / Chrome-nikel satin / chrome-nikel satin / Chrom-Nikel-Satin /
хром-никелевый атлас
BACKET

61* NICHEL NERO SATINATO OPACO / Black matt satin nickel / Nickel noir mat satiné / Schwarzer
Nickel / Сатиновый матовый черный никель
RAIL / MEDEA / ELITE / URANIA / HASHI

HQC HQC PRODOTTO ESTERNO CON CONTROLLO DI QUALITÀ / high quality control for external production /
Produit externe avec contrôle de qualité / Externes Produkt mit Qualitätskontrolle /
Внешний продукт с контролем качества

QUALITÀ GARANTITA

QUALITY GUARANTEED / QUALITÉ GARANTIE / QUALITÄT GARANTIE / КАЧЕСТВО GARANTEED



GARANZIA

La STILHAUS riconosce una garanzia di 5 ANNI (con decorrenza dalla data d'acquisto comprovata dalla ricevuta o scontrino fiscale) sui propri prodotti i sul catalogo e con apposito tagliando nella confezione. La garanzia comporta per STILHAUS unicamente l'obbligo di provvedere alla sostituzione dei prodotti riconosciuti difettosi con l'esclusione di ogni altra prestazione così come le spese di trasporto, l'indennizzo o risarcimento per danni diretti o indiretti. La garanzia è valida solo se le non conformità dichiarate sono riconducibili a difetti di fabbricazione, riconosciute da personale autorizzato dal costruttore e se le istruzioni d'uso siano state seguite correttamente. Sono esclusi dalla garanzia le parti soggette a normale usura e le parti e/o componenti che dovessero risultare difettosi o danneggiati a causa di danni accidentali per incuria o inadeguato trattamento, per uso ed installazione impropri, e da successive manipolazioni eseguite da personale non autorizzato dal costruttore e/o dalla loro esposizione ad agenti corrosivi e/o abrasivi anomali. Stilhaus Arredo Bagno declina qualsiasi responsabilità per eventuali danni a persone, animali o cose, causati da errori d'installazione o imperfetto utilizzo o dalla mancata osservanza di tutte le prescrizioni contenute nelle informazioni che accompagnano il prodotto. Per ogni controversia in merito, il Foro competente è quello di Viterbo.

PULIZIA

Tutte le parti che compongono il prodotto possono essere pulite utilizzando un panno morbido imbevuto di detergenti liquidi per la pulizia della casa a base neutra. Consigliamo di asciugare il prodotto dopo l'uso con un panno asciutto. Non usare assolutamente detersivi abrasivi, sostanze infiammabili chimicamente aggressive e altri solventi.

TOLLERANZE - Le illustrazioni dei nostri prodotti, deplianti e cataloghi, non costituiscono impegno di fedele riproduzione, la ditta si riserva il diritto di apportare modifiche ai propri prodotti senza l'obbligo di preavviso.

PRODUZIONE ARTIGIANALE DELLE CERAMICHE

I nostri articoli in ceramica sono realizzati manualmente per colaggio, senza l'utilizzo di stampi industriali, la presenza di piccoli punti è caratteristica dell'artigianalità del prodotto.

PRESTAZIONI ESTETICHE E METODI DI CONTROLLO:

Il controllo di qualità viene effettuato secondo le seguenti specifiche:

- Occhio nudo, corretto se necessario

Distanza

- Corrispondente all'uso standard e funzionale
- In posizione eretta, con 50 cm tra l'occhio l'oggetto.

Visibilità

- Corrispondente alle condizioni operative

Zone di visualizzazione:

I componenti dei nostri articoli sono soggetti alle zone di visualizzazione definite nella tabella seguente. Queste zone di osservazione riflettono il livello di criticità nei confronti dell'utente finale e determinano il livello di accettabilità dei difetti

Zona 1

sporco non ammesso - non più di 1 punto inferiore a dia. 1 mm - non più di 1 graffio inferiore a 3 mm

- una zona visibile in modo permanente.

oppure

- una zona alternativamente nascosta o visibile (ad esempio: interno scopino)

Zona 2

sporco non ammesso - non più di 2 punti inferiori a 2 mm - non più di 2 graffi inferiori a 5 mm

Definita come zona nascosta in modo permanente (ad es. Sotto di una ceramica, ecc.).

Tolleranze in millimetri, inferiore al 5 % della misura totale.

WARRANTY

STILHAUS recognizes a 5-YEAR warranty (with effect from the date of purchase proven by the receipt) on its products in the catalog and with a special coupon in the package. The guarantee involves STILHAUS only the obligation to provide for the replacement of defective products with the exclusion of any other service as well as transport costs, compensation or compensation for direct or indirect damages. The warranty is valid only if the declared non-conformities are attributable to manufacturing defects, recognized by personnel authorized by the manufacturer and if the instructions for use have been followed correctly. Parts subject to normal wear and damage due to carelessness or inadequate installation or subsequent manipulations carried out by personnel not authorized by the manufacturer and / or their exposure to abnormal corrosive and / or abrasive agents are excluded from the guarantee. Stilhaus Arredo Bagno declines any for any damage to persons, animals or things, caused by installation errors or imperfect use or failure to comply with all the responsibilities contained in the information accompanying the product. For any dispute in this regard, the competent court is that of Viterbo.

CLEANING

All parts of the product can be cleaned with a soft soaked in neutral-based liquid household cleaning detergent. We recommend wiping the product after use with a dry cloth. Never use abrasive detergents, chemically aggressive flammable substances and other solvents.

TOLERANCES - The illustrations of our products, brochures and catalogs are not committed to faithful reproduction, the company reserves the right to make changes to its products without prior notice.

ARTISAN PRODUCTION OF CERAMICS

Our ceramic items are made manually by casting, without the use of industrial molds, the presence of small points is characteristic of the product's craftsmanship.

AESTHETIC PERFORMANCE AND CONTROL METHODS:

Quality control is carried out according to the following specifications:

- Naked eye, corrected if necessary

Distance

- Corresponding to standard and functional use
- In an upright position, with 50 cm between the eye and the object.

Visibility

- Corresponding to the operating conditions

Display area:

The components of our items are subject to the display zones defined in the table below. These observation areas reflect the level of criticality in the comparisons to the end user and determine the level of acceptability of the defects

Zone 1 -

dirt not erased - no more than 1 point less than 1 mm diameter -no more than 1 scratch less than 3mm

- a permanently visible area.

or

- an alternately hidden or visible area (for example: internal toilet brush)

Zone 2

dirt not erased - no more than 2 points less than 2 mm - no more than 2 scratches less than 5mm

Defined as a permanently hidden area (eg under a ceramic, etc.).

Tolerances in millimeters, less than 5% of the total measurement.

PERSONALIZZAZIONE LASER

LASER CUSTOMISATION / PERSONNALISATION DU LASER / LASERINDIVIDUALISIERUNG / ЛАЗЕРНАЯ ПЕРСОНАЛИЗАЦИЯ

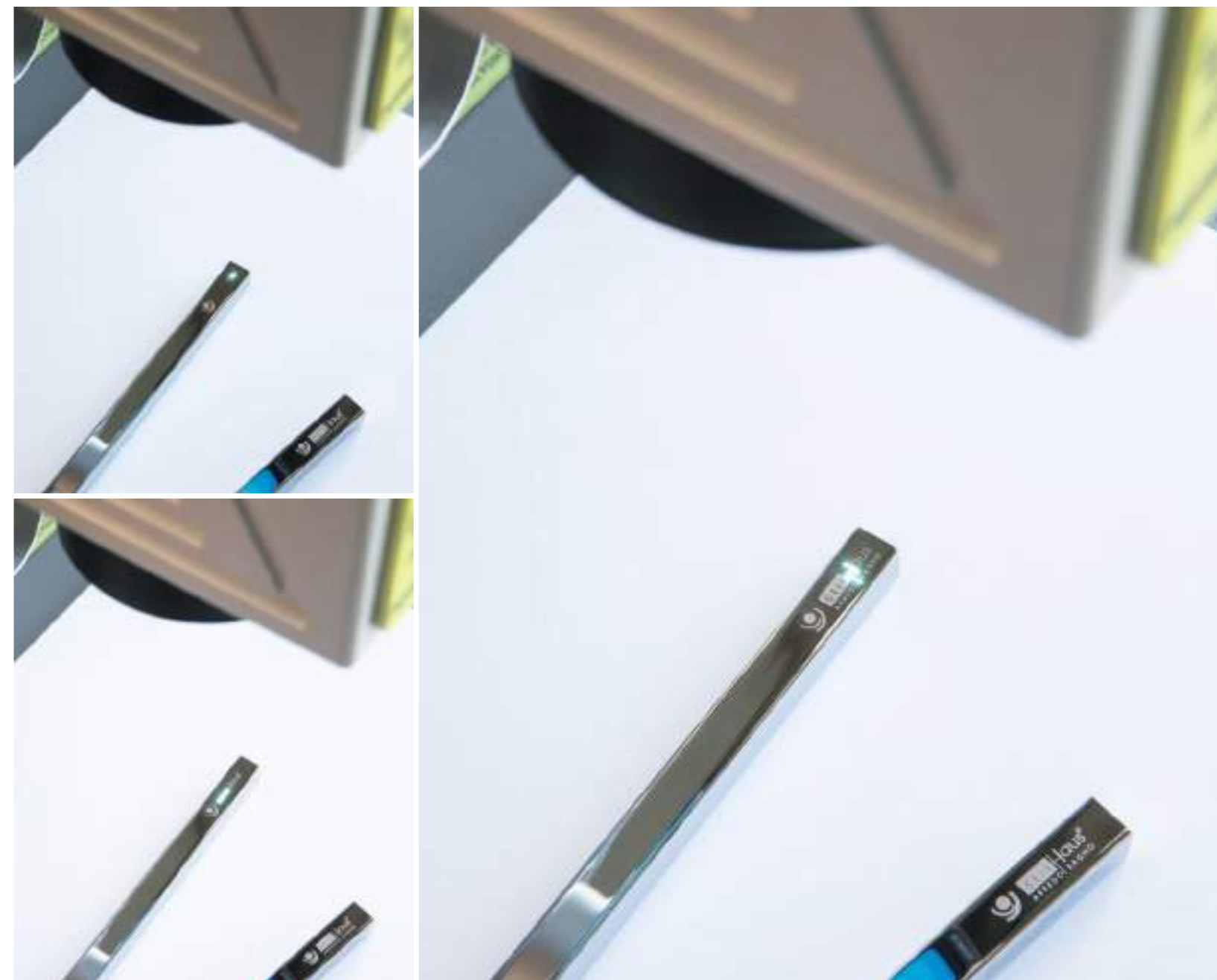

Possibilità di personalizzare accessori o prodotti con il logo o il nome della struttura alberghiera. Necessario l'invio di file in formato adatto (dxf o vettoriale).

Prezzo di listino € 2.50 a logo
Minimo 50 pezzi.

Accessories or products can be customized with the logo or name of the hotel. It is necessary to send files in a suitable format (dxf or vectorial).

List price € 2.50 per logo
Minimum 50 pieces

Possibilité de personnaliser des accessoires ou des produits avec le logo ou le nom de l'hôtel. Les fichiers doivent être envoyés dans un format approprié (dxf ou vectoriel).

Prix de liste : 2,50 € par logo
Minimum 50 pièces.

Möglichkeit der individuellen Gestaltung von Zubehör oder Produkten mit dem Logo oder Namen des Hotels. Die Dateien müssen in einem geeigneten Format (dxf oder Vektor) eingereicht werden.

Listenpreis € 2,50 pro Logo
Mindestens 50 Stück.

Возможность персонализации аксессуаров или продуктов с логотипом или названием отеля. Необходимо прислать файлы в подходящем формате (dxf или вектор).

Прейскурантная цена € 2,50 за логотип
Минимум 50 штук.

È vietata la riproduzione totale o parziale di foto e illustrazioni contenute in questo catalogo.
Partial total or of contained photos and illustrations in this catalogue is prohibited the reproduction.
Elle est défendue la reproduction totale ou partiel de photos et d'illustrations contenues dans ce je catalogue.
Запрещается полное или частичное воспроизведение фотографии и иллюстрации, содержащиеся в этом каталоге.



www.stilhaus.it



Stilhaus Arredo Bagno srl

Via della chimica, n°4 - 01100 Viterbo Italy
Tel. +39/0761.352736
www.stilhaus.it - e-mail: stilhaus@stilhaus.it

PHOTO: Fotostudio Mauro Mattioli - Viterbo
GRAFICA: Fotostudio Mauro Mattioli - Viterbo
PRINTING: ArtiGraficheCelori - Terni

Si ringrazia:
Effepi Rubinetterie SRL - Webert rubinetterie SRL
Emmevi rubinetterie SRL - Scarabeo ceramiche SRL
Olimpia cermica SRL

Finito di stampare nel mese di
Maggio 2022



NECESSARI PER IL BAGNO

WWW.STILHAUS.IT