

Vertigo.evolution

V.



PUNTOTRE

WWW.PUNTOTRE.COM



V.

Vertigo. evolution

Crescere, Maturare, Evolvere Vertigo Evolution.

Growing, Maturing, Evolving Vertigo Evolution.

Grandir, Mûrir, Évoluer Vertigo Evolution.



V.

Index.

COMP. VE 01
pag. 06/13

COMP. VE 02
pag. 14/21

COMP. VE 03
pag. 22/29

COMP. VE 04
pag. 30/37

COMP. VE 05
pag. 38/45

COMP. VE 06
pag. 46/53

COMP. VE 07
pag. 54/61

COMP. VE 08
pag. 62/69

COMP. VE 09
pag. 70/77

COMP. VE 10
pag. 78/85

COMP. VE 11
pag. 86/93

COMP. VE 12
pag. 94/101

COMP. VE 13
pag. 102/109

COMP. VE 14
pag. 110/117

finiture finishes finitions
pag. 118/121

abbinamenti consigliati
suggested combinations
associations recommandées
pag. 122/123

elenco composizioni
compositions' list
liste des compositions
pag. 124/127

Vertigo. evolution

Una proposta che trasmette dinamismo e flessibilità, efficace nella capacità contenitiva, risulta comunque leggera nel suo insieme, grazie agli elementi sfalsati ed al gioco delle tonalità.

A proposal that conveys dynamism and flexibility, effective in its storage capacity, it is nevertheless light as a whole, thanks to the staggered elements and the play of shades.

Une proposition qui transmet dynamisme et flexibilité, efficace dans sa capacité de rangement, et qui est néanmoins légère dans son ensemble, grâce aux éléments décalés et au jeu des nuances.

COMP. VE 01







^ Gli elementi BLADE, con la loro linea minimale, risultano efficaci complementi per la valorizzazione della composizione. Vedere a listino gli articoli disponibili.

The BLADE elements, with their minimal line, are effective complements for enhancing the composition. See available articles in the price list.

Les éléments BLADE, avec leur ligne minimale, mettent en valeur la composition. Consulter la liste de prix pour les articles disponibles.

Il vetro ha sempre rappresentato una scelta vincente nella realizzazione di top con vasca integrata, offrendo la massima flessibilità nelle colorazioni, in questa veste con superficie acidata, esprime anche una sofisticata eleganza. >

Glass has always been a winning choice in the realisation of tops with integrated bowl, offering maximum flexibility in colours; in this guise with an acid-etched surface, it also expresses sophisticated elegance.

Le verre a toujours été un choix gagnant dans la réalisation de plans avec vasque intégrée, offrant une flexibilité maximale dans les couleurs ; dans cette version avec surface dépolie à l'acide, il exprime par ailleurs une élégance sophistiquée.





COMP. VE 01 VERTIGO EVOLUTION

Linee e volumi che giocano insieme, la parte con finitura lignea del mobile, si abbina perfettamente agli elementi colorati.

Lines and volumes play together, the wooden-finished part of the furniture matches perfectly coloured elements.

Lignes et volumes qui jouent ensemble, la partie du meuble en finition bois s'accorde parfaitement avec les éléments colorés.

- 01 Lo specchio STEP, è progettato per incastonarsi su basi o top scatolati, fondendosi in un unico elemento con la composizione. / The STEP mirror is designed to fit into units or boxed tops, merging into a single element with the composition. / Le miroir STEP, est conçu pour s'encastrent dans les meubles ou plans-vasque, se fondant en un seul élément dans la composition.
- 02 Mensola BLADE, creata per adattarsi agli specchi a muro, è disponibile in Nero Opaco, oppure nelle finiture metalliche del nostro listino (opzionale). / BLADE shelf, created to fit the wall mirrors, is available in matt black, or in the metal finishes in our price list (optional). / L'étagère BLADE, créée pour s'adapter aux miroirs muraux, est disponible en Noir Mat, ou dans les finitions métalliques de notre liste de prix (en option).
- 03 Top in vetro acidato con vasca integrata, molte sono le opzioni di sagoma disponibili, così come la gamma di colorazioni che comprende l'intera gamma RAL. / Etched glass top with integrated basin, many shape options are available, as is the range of colours including the entire RAL range. / Plan en verre dépoli à l'acide avec vasque intégrée, les options de formes disponibles sont nombreuses, ainsi que la gamme de couleurs qui comprend toute la gamme RAL.

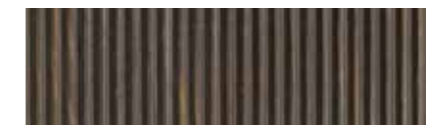

Polimerico 188X Thermo A



L016M Grigio Quarzo Opaco



Vetro Acidato L016M Grigio Quarzo

Vertigo. evolution

Vertigo Evolution sa sorprendere con la sua nuova linea sinuosa, una morbida curva che crea un elegante cambio di profondità.

Vertigo Evolution surprises with its new sinuous shape, a soft curve that creates an elegant change of depth.

Vertigo Evolution surprend par sa nouvelle ligne sinueuse, une courbe délicate qui crée un changement élégant de profondeur.

COMP. VE 02







Nei dettagli a fianco, viene evidenziata la morbida ed elegante curva che caratterizza questa versione, il top in Ocritech propone anche una vasca dedicata a questa soluzione.

In the details on the side, the soft and elegant curve that characterises this version is highlighted; the Ocritech top also features a dedicated basin.

Les détails ci-contre mettent en évidence la courbe délicate et élégante qui caractérise cette version ; le plan en Ocritech propose aussi une vasque dédiée à cette solution.

< Vertigo Evolution può tranquillamente attingere alla estesa gamma di elementi contenitivi della sua versione originale con maniglia, creando gradevoli giochi di abbinamento.

Vertigo Evolution can easily draw on the extensive range of storage elements of its original version with handle, creating pleasing combinations.

Vertigo Evolution peut facilement puiser dans la vaste gamme d'éléments de rangement de sa version originale avec poignée, créant ainsi des combinaisons agréables.





•01

•02

COMP. VE 02 VERTIGO EVOLUTION

Elegante ed esclusiva nella sua semplicità, questa soluzione risulta pratica e fruibile per un vasto pubblico.

Elegant and exclusive in its simplicity, this solution is practical and usable for a wide audience.

Élégante et exclusive dans sa simplicité, cette solution est pratique et destinée à un large public.

- 01 Gli specchi LUX4, nella versione a misura, dispongono dell'opzione LED a 3000K° senza maggiorazione di costo. / LUX4 mirrors, are also available, when made by measure, also with LED light 3000K°. / Les miroirs LUX4, dans la version sur mesure, ont une option à LED 3 000K° sans supplément de prix.
- 02 I frontali di Vertigo Evolution, aggiornati ora con la versione a gola, rendono il mobile più essenziale e pulito nelle sue forme. / The Vertigo Evolution fronts, now updated with a groove version, make the cabinet more essential and clean in its shape. / Les façades Vertigo Evolution, actualisées avec une ouverture à gorge, rendent le meuble plus essentiel dans sa forme.

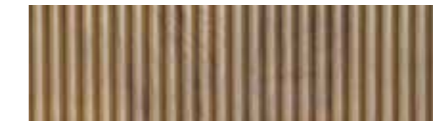

186X Dark Rockford

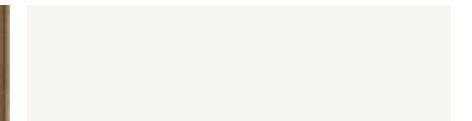

Ocritech Bianco Opaco

Vertigo. evolution

Una interessante interpretazione della soluzione del bagno per la coppia, non solo distinta da due mobili separati, ma anche enfatizzata da due tonalità di colore.

An interesting interpretation of the bathroom solution for the couple, not only distinguished by two separate vanities, but also emphasised by two shades of colour.

Une interprétation intéressante de la solution de la salle de bains pour le couple, qui se distingue par deux meubles séparés, mais qui est aussi emphatisée par deux nuances de couleur.

COMP. VE 03







< Grazie alla flessibilità offerta dai nuovi piani in Minerltek color, proporre la soluzione di monile monolitico è davvero ad ampio spettro, potendo contare su tutte le 50 tonalità della nostra gamma colore.

Thanks to the flexibility offered by the new Minerltek colour tops, offering the monolithic solution is truly wide-ranging, relying on all 50 shades of our colour range.

Grâce à la flexibilité offerte par les nouveaux plans en Minerltek coloré, la solution monolithique proposée est vraiment très vaste, pouvant compter sur les 50 teintes de notre gamme de couleurs.

< In questo scorcio dall'alto, si evidenzia la caratteristica della curva delle nuove basi lavabo, nate per dare una risposta a soluzioni di spazio, non rinunciano al valore estetico e minimale del mobile in se.

In this view, we highlight the characteristic curve of the new washbasin base units, created to provide an answer to space solutions, they do not renounce the aesthetic and minimalist value of the cabinet itself.

Cette vue du haut souligne la courbe caractéristique des nouveaux caissons lavabo, créés pour apporter une réponse aux solutions d'espace, sans renoncer à la valeur esthétique et minimaliste du meuble en soi.





COMP. VE 03 VERTIGO EVOLUTION

La versione "nuda" di questa composizione evidenzia il ricercato gioco di volumi e spazi, a loro volta enfatizzati dalle cornici di luce degli specchi.

The "naked" version of this composition highlights the refined play of volumes and spaces, which are emphasised by the light frames of the mirrors.

La version « nue » de cette composition met en évidence le jeu raffiné des volumes et des espaces, à leur tour emphasisés par les encadrements lumineux des miroirs.

- 01 Specchi LUX4 disponibili con dimensioni personalizzate e variante di tonalità luminosa a 3000K° nelle versioni "su misura". / LUX4 mirrors available with customised dimensions and 3000K° light colour variant in customised versions. / Les miroirs LUX4 sont disponibles dans des dimensions personnalisées et des variantes de tonalité lumineuse de 3000K° dans les versions « sur mesure ».
- 02 Specchio ingranditore con fattore x3 con attacco magnetico su piastra metallica su libera installazione sui nostri specchi a muro. / Magnifying mirror with x3 factor with magnetic attachment on metal plate for free installation on our wall mirrors. / Miroir grossissant avec facteur x3 avec fixation magnétique sur plaque métallique pour une installation libre sur nos miroirs muraux.
- 03 Effetto monolitico per top e mobile, utilizzando il Mineraltek Color, sono disponibili tutte le nostre 50 tonalità. / Monolithic effect for top and cabinet, using Mineraltek Colour, all our 50 shades are available. / Effet monolithique pour le plan et le caisson, avec le Mineraltek Color, nos 50 teintes sont toutes disponibles.

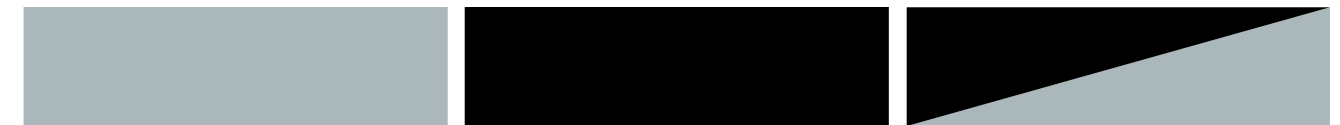

L054M Bruma Opaco

L017M Grigio Blu Opaco

Mineraltek Color

Vertigo. evolution

“Total White”, il principe dei colori, elegante e sensuale, il solo che riesca a mettere in evidenza i preziosi dettagli della composizione.

“Total White”, the prince of colours, elegant and sensual, the only one that can highlight the precious details of the composition.

« Total White », le prince des couleurs, élégant et sensuel, le seul qui puisse mettre en valeur les détails précieux de la composition.

COMP. VE 04







Meridian, una nuova ed esclusiva lampada con montaggio a parete, che non necessita di punto luce dedicato. Interessante e pratica la funzione regolabile del suo braccio.

Meridian, a new and exclusive wall-mounted lamp, which does not require a dedicated lighting point. The adjustable function of its arm is interesting and practical.

Meridian, une nouvelle lampe murale exclusive, qui ne nécessite pas de point d'éclairage dédié. Très intéressante et pratique, la fonction réglable de son bras.

v

Un tocco di raffinata tecnologia completa i nostri specchi illuminati, grazie all'interruttore capacitivo, che permette l'accensione e la funzione dimmer.

A touch of refined technology completes our illuminated mirrors, thanks to the capacitive switch, which enables the on/off and dimmer function.

Une touche de technologie raffinée complète nos miroirs lumineux, grâce à l'interrupteur capacitif qui permet l'allumage et la variation d'intensité.

< Una nuova vasca completa la gamma dei nostri piani Ocritech, con il suo design minimale e raffinato, Meta, può essere posizionata in modo asimmetrico o libero, lasciando libero sfogo alla creatività.

A new bowl completes the range of our Ocritech countertops. With its minimalist and refined design, Meta can be positioned asymmetrically or freely, giving free rein to creativity.

Une nouvelle vasque complète la gamme de nos plans en Ocritech ; avec son design minimaliste et raffiné, Meta peut être positionnée de manière asymétrique ou libre, laissant libre cours à la créativité.





COMP. VE 04 VERTIGO EVOLUTION

Forme e volumi giocano insieme in questa proposta, creando un insieme davvero intrigante, senza rinunciare a praticità e fruibilità.

Shapes and volumes play together in this proposal, creating a truly intriguing ensemble without sacrificing practicality and usability.

Les formes et les volumes jouent ensemble dans cette proposition, créant un ensemble vraiment intrigant, sans pour autant sacrifier l'aspect pratique et la facilité d'utilisation.

- 01 Lampada Meridian, in questo caso, viene alimentata direttamente dalla specchiera, alla quale deve risultare direttamente accostata, per permettere il passaggio dei cavi di alimentazione. / Meridian lamp, in this case, is powered directly from the mirror, to which it must be directly attached, to allow the power supply cables to pass through. / La lampe Meridian, dans ce cas, est alimentée directement par le miroir, auprès duquel elle doit être directement positionnée pour permettre le passage des câbles d'alimentation.
- 02 Lo specchio Sunset con illuminazione LED integrata a 3000K°, può disporre ora di un interruttore capacitivo (optional), per accensione e regolazione dimmer. / The Sunset mirror with integrated 3000K° LED lighting can now be equipped with a capacitive switch (optional), for switching and dimming. / Le miroir Sunset avec éclairage à LED 3000K° intégré peut désormais être équipé d'un interrupteur capacitif (en option) pour l'allumage et la gradation d'intensité.
- 03 Le vasche Meta, sono costruite integrando direttamente i nostri piani scatolati, in questo caso, devono rimanere in altezza 12cm / Meta bowls, are constructed by directly integrating our box tops, in this case, they must remain 12cm in height. / Les vasques Meta, sont construites en intégrant directement nos plans-vasque, dans ce cas, elles doivent garder une hauteur de 12 cm

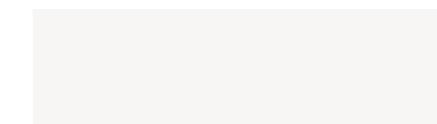

L001M Bianco Opaco

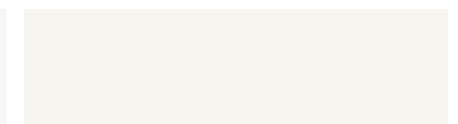

Ocritech Bianco Opaco

Vertigo. evolution

Il nuovo Vertigo Evolution, nella sua forma curva, in questa veste Nero Grafite, risulta sensuale come pochi e cattura immediatamente lo sguardo.

The new Vertigo Evolution, in its curved, Graphite Black guise, is as sensual as few and immediately catches the eye.

Le nouveau Vertigo Evolution dans sa forme courbe, dans cette version Noir Graphite, est sensuel comme peu d'autres et attire immédiatement l'attention.

COMP. VE 05







I top in Mineraltek dispongono di una vasta scelta per le sagome delle vasche, verificarne a listino la compatibilità con le nuove basi curve.

Mineraltek tops have a wide choice of basin shapes, check the price list for compatibility with the new curved bases.

Les plans en Mineraltek offrent un large choix de formes pour les vasques ; vérifier la liste de prix pour la compatibilité avec les nouveaux caissons courbes.

In questa proposta, lo specchio DIX con illuminazione integrata, diventa l'ideale estensione dei colori di top e mobile, per un effetto monocromatico di insieme.

In this proposal, the DIX mirror with integrated lighting becomes an ideal extension of the top and vanity colours, for an overall monochromatic effect.

Dans cette proposition, le miroir DIX avec éclairage intégré devient un prolongement idéal des couleurs du plan et du caisson, pour un effet monochrome global.





•01



•02

COMP. VE 05 VERTIGO EVOLUTION

Come un elegante vestito, la monocromia di questa proposta ne enfatizza esclusività ed armonia, per un risultato di sicuro effetto.

Like an elegant dress, the monochrome of this proposal emphasises exclusivity and harmony, for an impressive result.

Comme une robe élégante, le monochrome de cette proposition souligne son exclusivité et son harmonie, pour un résultat impressionnant.

- 01 Specchio DIX, disponibile in unica soluzione di dimensione e finitura, al fine di accentuarne l'esclusività. / DIX mirror, available in single size and finish to accentuate exclusivity. / Miroir DIX, disponible dans une seule taille et une seule finition pour souligner son exclusivité.
- 02 I top in Mineraltek, posso attingere alla completa gamma cromatica delle nostre laccature, trasformate successivamente in tonalità di gelcoat, per rendere la superficie adatta all'utilizzo del bagno domestico. / Mineraltek tops can draw on the full colour range of our lacquers, subsequently transformed into gelcoat shades, to make the surface suitable for domestic bathroom use. / Les plans en Mineraltek sont disponibles dans toute la gamme de couleurs de nos laques, transformées ensuite en nuances de gelcoat, pour adapter la surface à l'usage de la salle de bains.

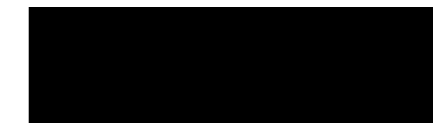

L049M Nero Grafite Opaco

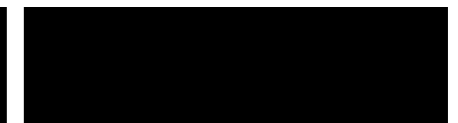

Mineraltek L049M Nero Grafite Opaco

Vertigo. evolution

La combinazione cromatica di questa soluzione, crea un effetto monolitico con mobile e consolle, proponendo per entrambi l'attualissimo colore verde salvia.

The colour combination of this solution creates a monolithic effect with the cabinet and console, offering for both the very up-to-date sage green colour.

La combinaison de couleurs de cette solution crée un effet monolithique avec le meuble et la console, offrant pour les deux la couleur vert sauge, très actuelle.

COMP. VE 06





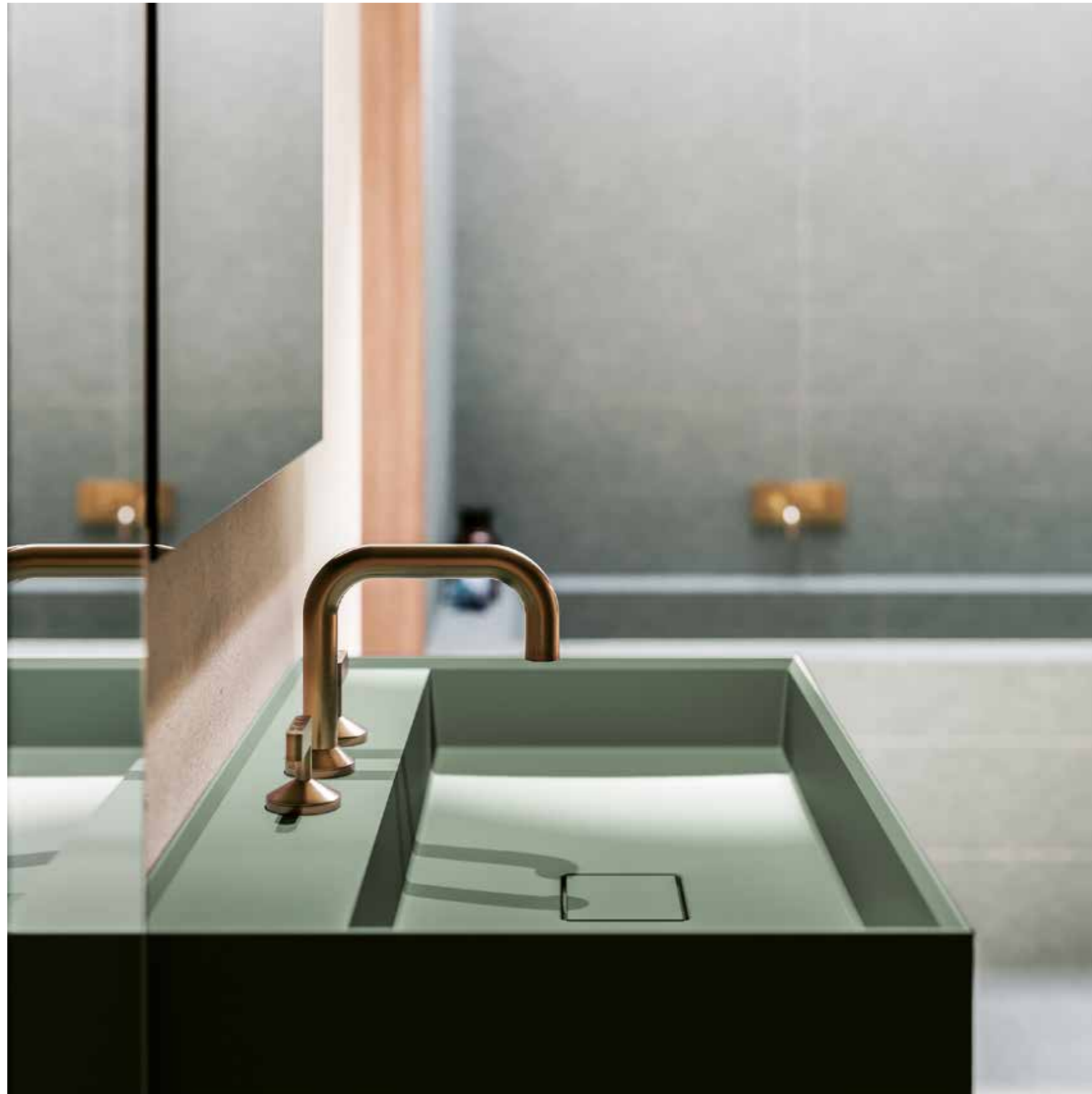

La purezza delle linee della consolle e del fianco, enfatizzano l'effetto cannettato dei frontali Vertigo Evolution.

The purity of the lines of the console and the side carcass, emphasise the fluted effect of the Vertigo Evolution fronts.

La pureté des lignes de la console et de la joue latérale souligne l'effet nervuré des façades Vertigo Evolution.

Le lampade Thin, sono divenute ormai un elemento > ampiamente utilizzato per arredare la sala da bagno. Grazie al cavo flessibile ed agli snodi che vengono forniti, si possono realizzare anche simpatici intrecci.

Thin lamps have now become a widely used element for furnishing the bathroom. Thanks to the flexible cable and the joints that are supplied, they can also be made into nice interlaces.

Les lampes Thin sont désormais un élément largement utilisé pour meubler la salle de bains. Grâce au câble flexible et aux joints d'articulation fournis, elles peuvent être utilisées aussi pour créer des entrelacements attrayants.

< Le nuove consolle COLOR vantano la possibilità di attingere a 12 colorazioni della nostra gamma, oltre al Bianco Opaco e Nero Opaco. Interessante la sagoma del bordo vasca che funge da salva-goccia .

The new COLOR consoles boast a choice of 12 colours from our range, in addition to Matt White and Matt Black. The shape of the console rim, which acts as a drip guard, is interesting.

Les nouvelles consoles COLOR offrent un choix de 12 couleurs de notre gamme, en plus du Blanc Mat et du Noir Mat. Très intéressant, le profil du bord de la vasque qui fait office de pare-gouttes.





COMP. VE 06 VERTIGO EVOLUTION

Linee rigorose e pulite per una soluzione dal minimo ingombro ma dalla grande capacità contenitiva.

Rigorous, clean lines for a solution with minimal space but great storage capacity.

Des lignes rigoureuses et épurées pour une solution à encombrement minimal mais à grande capacité de rangement.

- 01 Gli specchi LUX4, nella versione a misura, dispongono dell'opzione LED a 3000K° senza maggiorazione di costo. / LUX4 mirrors, are also available, when made by measure, also with LED light 3000K°. / Les miroirs LUX4, dans la version sur mesure, disposent de l'option LED 3000K° sans supplément de prix.
- 02 Le consolle COLOR, sono disponibili in 4 diverse misure ed offrono 12 colorazioni prese dalla nostra gamma di laccature, proprio per enfatizzare l'effetto monolitico dell'insieme. / COLOR consoles are available in 4 different sizes and offer 12 colours taken from our lacquer range, precisely to emphasise the monolithic effect of the whole. / Les consoles COLOR sont disponibles en 4 tailles différentes et offrent 12 couleurs tirées de notre gamme de laques, précisément pour souligner l'effet monolithique de l'ensemble.
- 03 I frontali di Vertigo Evolution, in questa soluzione, creano un simpatico effetto asimmetrico, lasciando la gola aperta su un lato. / The fronts of Vertigo Evolution, in this solution, create a nice asymmetrical effect, leaving the groove open on one side. / Les façades de Vertigo Evolution, dans cette solution, créent un bel effet asymétrique, laissant la gorge ouverte d'un côté.



L060M Verde Salvia Opaco



Compact L060M Verde Salvia Opaco

Vertigo. evolution

Una proposta importante, che, proprio grazie alle sue generose dimensioni, riesce ad esprimere tutta l'esclusività del nuovo Vertigo Evolution.

An important proposal, which, thanks to its generous dimensions, manages to express all the exclusivity of the new Vertigo Evolution.

Une proposition importante qui, grâce à ses dimensions généreuses, parvient à exprimer toute l'exclusivité du nouveau Vertigo Evolution.

COMP. VE 07







Qui a lato. La raffinata lavorazione delle gole, necessità di capacità e tecnologia di primordine per la sua realizzazione.

Here to the side. The fine workmanship of the grooves requires first-class skills and technology for its realisation.

Ci-contre. Le travail raffiné des gorges exige des compétences et une technologie de premier ordre pour leur réalisation.

< A sinistra. Un tocco di esclusività fornito dalle mensole HORIZON, nel ricercato abbinamento tra il Grigio Quarzo Lucido e la finitura Ottone Art.

Left. A touch of exclusivity provided by the HORIZON shelves, in the sophisticated combination of Polished Quartz Grey and Art Brass finish.

À gauche. Une touche d'exclusivité conférée par les étagères HORIZON, dans la combinaison raffinée du Gris Quartz Brillant et de la finition Laiton Art.





COMP. VE 07 VERTIGO EVOLUTION

Come in un domino, le forme si incastrano e creano affascinanti giochi di ombre e luci, in questa ricercata composizione.

Like dominoes, the shapes interlock and create fascinating plays of light and shadow in this sophisticated composition.

Comme des dominos, les formes s'imbriquent et créent de fascinants jeux d'ombre et de lumière dans cette composition sophistiquée.

- 01 Tutti gli specchi LUX illuminati delle nostre collezioni, sono disponibili anche a misura variabile, consentendo di creare ricercati effetti di luce nelle pareti. / All LUX illuminated mirrors in our collections are also available in variable sizes, allowing you to create sophisticated lighting effects on walls. / Tous les miroirs éclairés LUX de nos collections sont disponibles aussi en tailles variables, ce qui permet de créer des effets lumineux sophistiqués sur les murs.
- 02 Le mensole Horizon, sono ormai consolidati complementi nella nostra linea di arredo, con una ampia gamma di soluzioni e finiture. / Horizon shelves are now established complements in our furniture line, with a wide range of solutions and finishes. / Les étagères Horizon sont des compléments bien établis de notre gamme d'ameublement, avec un large éventail de solutions et de finitions.
- 03 Il lavabo SEI BIG in solid colorato Grigio Quarzo, si abbina perfettamente alle tonalità della composizione. Vedere a listino le 12 tonalità disponibili. / The SEI BIG washbasin in solid, is painted in Quartz Grey, perfectly matching the colours of the composition. See the price list for the 12 available shades. / Le lavabo SEI BIG dans le coloris Gris Quartz s'harmonise parfaitement avec les couleurs de la composition. Voir la liste des prix pour les 12 teintes disponibles.



Polimerico 188X Thermo A



GR16 Pietra Iseo

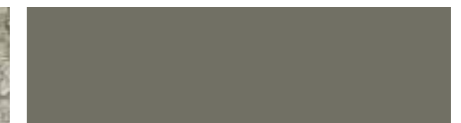

L016G Grigio Quarzo Lucido

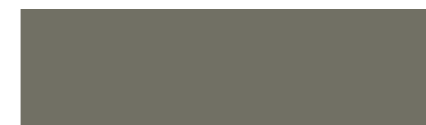

GR05 Grigio Quarzo

Vertigo. evolution

Una proposta che unisce le due anime di questo nuovo modello, dove la base curva di sinistra, diventa il naturale complemento del porta-lavabo dritto, a destra.

A proposal that unites the two souls of this new model, where the curved unit on the left becomes the natural complement to the straight washbasin unit on the right.

Une proposition qui unit les deux âmes de ce nouveau modèle, où la base incurvée de gauche devient le complément naturel du support de lavabo droit de droite.

COMP. VE 08







Tra le molte opportunità progettuali offerte nel nostro > catalogo, vi è anche quella dello specchio con taglio per adattarsi ad altri elementi. Verificare le possibilità a listino.

Among the many design opportunities offered in our catalogue, there is also the mirror with a cut-out to fit other elements. Check the possibilities in the price list.

Parmi les nombreuses possibilités de conception offertes dans notre catalogue, il y a aussi le miroir avec une découpe pour s'adapter à d'autres éléments. Vérifier les possibilités dans la liste de prix.

Questa variante MERIDIAN 2 della lampada, consente > la sua installazione sia sul profilo superiore che laterale dello specchio.

This MERIDIAN 2 variant of the lamp allows it to be installed on either the top or side profile of the mirror.

La variante MERIDIAN 2 de la lampe permet de l'installer sur le profil supérieur ou latéral du miroir.

< La serie di vasche CUT, disponibile in varie dimensioni e materiali, mantiene intatta l'essenzialità estetica, senza penalizzarne la praticità di utilizzo.

The CUT washbasin series, available in various sizes and materials, retains its aesthetic essentiality without penalising practicality.

La série de vasques CUT, disponible en plusieurs tailles et matériaux, conserve son essentialité esthétique sans pénaliser la praticité.





COMP. VE 08 VERTIGO EVOLUTION

Una proposta dal sapore nordico, dove l'effetto legno chiaro del polimerico Rovere Grain, si abbina al tono tenue del top in Mineraltek Bruma opaco.

A proposal with a Nordic flavour, where the light wood effect of the polymeric Oak Grain is combined with the soft shade of the matt Bruma Mineraltek.

Une proposition à la saveur nordique, où l'effet bois clair du Chêne Grain polymère s'harmonise avec le ton doux du plan en Mineraltek Bruma mat.

- 01 Lampada MERIDIAN 2, consigliata su specchio SP920 con profilo nero, qui posizionata sul fianco dello specchio stesso. / MERIDIAN 2 lamp, recommended on SP920 mirror with black profile, here positioned on the side of the mirror. / Lampe MERIDIAN 2, recommandée sur le miroir SP920 à profil noir, ici positionnée sur le côté-même du miroir.
- 02 Specchio BASIC a misura con profilo nero (SP920), qui proposto con una interessante soluzione di taglio per incastonarsi al mobile. / BASIC made-to-measure mirror with black profile (SP920), here proposed with an interesting cut-out solution to fit the cabinet. / Miroir BASIC sur mesure avec profil noir (SP920), ici proposé avec une solution intéressante de découpe pour s'encastrier dans le meuble.
- 03 I top in Mineraltek, sono ora disponibili con la nostra gamma di colorazioni laccate opache, lasciando libero sfogo alla creatività del designer. / Mineraltek tops are now available in our range of matt lacquer colours, giving the designer's creativity free rein. / Les plans en Mineraltek sont maintenant disponibles dans notre gamme de couleurs laquées mates, laissant libre cours à la créativité du décorateur.



Polimerico 183X Rovere Grain



Mineraltek L054M Bruma

Vertigo. evolution

La luce laterale mette in evidenza l'esclusivo effetto dei frontali Vertigo Evolution ed il ricercato gioco delle gole asimmetriche.

The side light underlines the unique effect of the Vertigo Evolution fronts and the sophisticated play of asymmetrical grooves.

L'éclairage latéral met en valeur l'effet des façades Vertigo Evolution et le jeu sophistiqué des gorges asymétriques.

COMP. VE 09







Interessante dettaglio per questa composizione, il lavabo COGNAC in ceramica nera opaca, è il complemento ideale per il nuovo top HPL in finitura JAZZ PLUS, con effetto anti-impronta che ne facilita anche la manutenzione.

An interesting detail for this composition, the COGNAC washbasin in matt black ceramic is the ideal complement to the new HPL top in JAZZ PLUS finish, with an anti-fingerprint effect that also facilitates maintenance.

Détail intéressant pour cette composition, le lavabo COGNAC en céramique noire mate, complément idéal du nouveau plan HPL en finition JAZZ PLUS, avec un effet anti-traces qui facilite l'entretien.

< Il nuovo specchio DIX con luce LED integrata, diventa un vero complemento d'arredo, la cui presenza enfatizza l'esclusività di ogni composizione.

The new DIX mirror with integrated LED light becomes a true furnishing accessory, whose presence emphasises the exclusivity of each composition.

Le nouveau miroir DIX avec lumière LED intégrée devient un véritable accessoire d'ameublement, dont la présence souligne l'exclusivité de chaque composition.





COMP. VE 09 VERTIGO EVOLUTION

Toni neutri ed eleganti per questa proposta dagli abbinamenti di sapore sartoriale, sa mantenere una raffinata esclusività, grazie all'equilibrio delle forme.

Neutral and elegant shades for this proposal with a sartorial flavour, it knows how to maintain a refined exclusivity, thanks to the balance of shapes.

Des tons neutres et élégants pour cette proposition à la saveur sartoriale, elle sait maintenir une exclusivité raffinée, grâce à l'équilibre des formes.

- **01** Specchio DIX in nero opaco con luce integrata a 3000K°, tono della luce naturale, disponibile in unica dimensione di 90cm. / DIX mirror in matt black with integrated 3000K° light, natural light tone, available in one size of 90cm. / Miroir DIX en noir mat avec lumière intégrée 3000K°, tonalité de lumière naturelle, disponible en une seule taille de 90cm.
- **02** Top in HPL con la nuova finitura Jazz Plus, esclusivo nella sua chiassosa eleganza. / Top in HPL with the new Jazz Plus finish, exclusive in its loud elegance. / Plan en HPL avec la nouvelle finition Jazz Plus, exclusive dans sa grande élégance.
- **02** Il lavabo Cognac in ceramica nera opaca, rappresenta solo una delle molteplici proposte presenti nella nostra offerta, in grado di soddisfare le esigenze più disparate. / The Cognac washbasin in matt black ceramic represents just one of the many proposals in our offer, capable of satisfying the most diverse requirements. / Le lavabo Cognac en céramique noire mate est l'une des nombreuses propositions de notre offre, capable de satisfaire les exigences les plus diverses.



L006M Grigio Luce Opaco



HPL H071 Jazz Plus



Ceramica Nera Opaca

Vertigo. evolution

Una proposta destinata a raccogliere i favori di una vasta fascia di pubblico, per la sua essenzialità e praticità, provvista di grandi volumi di stoccaggio, grazie alla nuova collezione di specchi contenitore CUBE, con vano a giorno integrato.

A proposal destined to win the favour of a wide segment of the public, for its essentiality and practicality, with large storage volumes, thanks to the new collection of CUBE storage mirrors, with integrated open compartment.

Une proposition destinée à gagner la faveur d'un vaste segment du public, en raison de son caractère essentiel et pratique, dotée de grands volumes de rangement, grâce à la nouvelle collection de miroirs de rangement CUBE, avec compartiment ouvert intégré.

COMP. VE 10







< Lo specchio CUBE è disponibile in diverse dimensioni a 2-3-4 ante, con il pratico vano a giorno inferiore che può essere illuminato da una striscia led dedicata.

The CUBE mirror is available in different sizes with 2-3-4 doors, with the practical lower open compartment that can be illuminated by a dedicated LED strip.

Le miroir CUBE est disponible en différentes tailles avec 2-3-4 portes, avec le compartiment inférieur ouvert pratique qui peut être éclairé par une bande LED dédiée.



In questo dettaglio, si evidenzia la nuova finitura Navajo Gold del top in HPL, una scelta mirata per un piano pratico e durevole, ma allo stesso tempo esclusivo. >

Highlighted in this detail is the new Navajo Gold finish of the HPL top, the right choice for a practical and durable, yet exclusive top.

Dans ce détail, nous soulignons la nouvelle finition Navajo Gold du plan en HPL, un choix ciblé pour un plan pratique et durable, mais aussi exclusif.





•01

•02

COMP. VE 10 VERTIGO EVOLUTION

Quasi un monolite questa composizione, dove anche la scelta della finitura del top è dettata dalla volontà di rimanere nelle tonalità del colore laccato.

Almost a monolith is this composition, where even the choice of the top finish is dictated by the desire to remain in the lacquered colour tones.

Cette composition est presque un monolithe, où même le choix de la finition du plan est dicté par le désir de rester dans les tons de la couleur laquée.

- 01 Specchio contenitore CUBE, con le caratteristiche ante a doppia facciata a specchio, permette la funzione trittico in modo efficace. / CUBE container mirror, with its characteristic double-sided mirrored doors, enables the triptych function effectively. / Ce miroir de rangement CUBE, avec ses portes miroir à double face caractéristiques, permet de réaliser la fonction triptyque.
- 02 Il piano in HPL di nuova generazione di questa composizione, ha un trattamento anti-impronta efficace, che conferisce alla superficie un effetto seta molto piacevole. / The new-generation HPL top of this composition has an effective anti-fingerprint treatment, giving the surface a very pleasant silk effect. / Le plan en HPL de nouvelle génération de cette composition bénéficie d'un traitement anti-traces qui confère à la surface un effet soyeux très agréable.



L056M Argilla Opaco



HPL H070 Navajo Gold

Vertigo. evolution

Un ambiente sofisticato ma rigoroso nei toni e nei volumi, proprio per enfatizzare la razionalità di una composizione votata alla praticità quotidiana, senza rinunciare all'esclusività di un modello ormai iconico tra le nostre proposte.

A sophisticated yet rigorous environment in terms of tone and volume, precisely to emphasise the rationality of a composition devoted to everyday practicality, without renouncing the exclusivity of a model that is now iconic among our proposals.

Une ambiance sophistiquée mais rigoureuse dans ses tons et ses volumes, afin de mieux souligner la rationalité d'une composition dédiée à la praticité quotidienne, sans renoncer à l'exclusivité d'un modèle désormais iconique parmi nos propositions.

COMP. VE 11





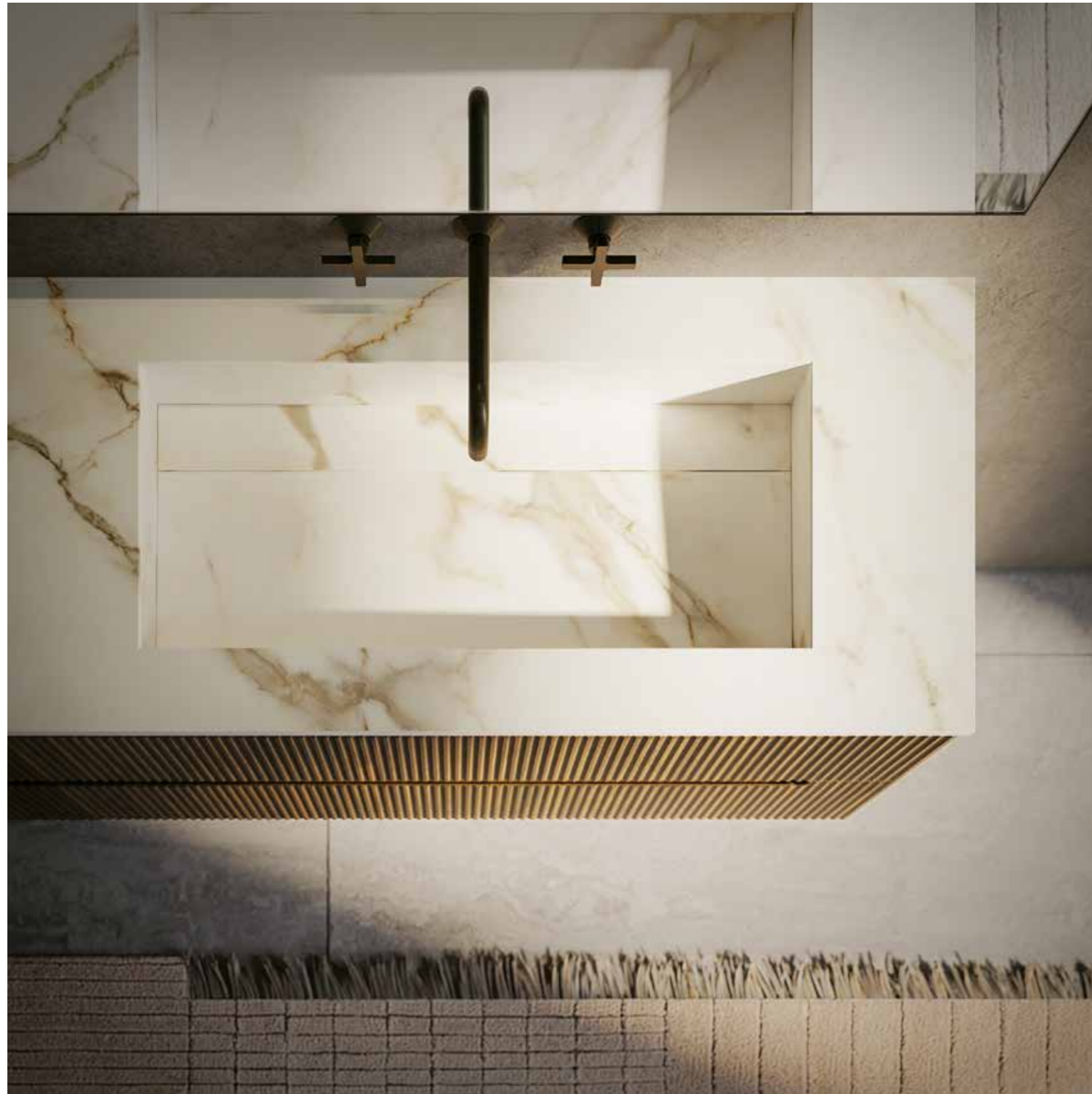

< Puntotre si avvale della collaborazione dei marchi più importanti ed innovativi nelle forniture di lastre gres per la realizzazione dei propri top. Questi sono soggetti alla disponibilità sul mercato per lo spessore delle lastre, pertanto, possono avere i bordi in massa ceramica o con finitura riportata, in modalità casuale.

Puntotre collaborates with the most important and innovative brands in the supply of stoneware slabs for the production of its tops. These are subject to market availability for the thickness of the slabs, so they can have the edges in ceramic mass or with a reported finish, at random.

Puntotre collabore avec les marques les plus importantes et innovantes dans la fourniture de dalles en grès pour la production de ses plans. Ceux-ci sont soumis à la disponibilité du marché pour l'épaisseur des dalles, de sorte qu'ils peuvent avoir les bords en masse céramique ou avec une finition rapportée.

∨ In questo scorcio, la sensazione di assoluto rigore, viene accentuata dal frontale cannettato, che con le sue linee verticali determina in modo significativo le geometrie dell'insieme.

In this glimpse, the feeling of absolute rigour is accentuated by the fluted front, whose vertical lines significantly determine the geometry of the whole.

Dans cet aperçu, la sensation de rigueur absolue est accentuée par la façade nervurée, dont les lignes verticales déterminent de manière significative la géométrie de l'ensemble.

< La vasca VEGA qui raffigurata, combina estetica minimalista con praticità e facilità manutentiva, data la possibilità di ispezionare e pulire facilmente lo scarico del lavabo.

The VEGA basin shown here combines minimalist aesthetics with practicality and ease of maintenance, as the basin drain can be easily inspected and cleaned.

La vasque VEGA présentée ici allie l'esthétique minimaliste à la praticité et à la facilité d'entretien, étant donné la possibilité de contrôler et de nettoyer facilement le drain du lavabo.





COMP. VE 11 VERTIGO EVOLUTION

Una proposta accattivante che grazie alla combinazione delle tonalità, enfatizza anche forme e volumi, per un risultato assolutamente apprezzabile.

An eye-catching proposal that, thanks to the combination of shades, also emphasises shapes and volumes, for an absolutely appreciable result.

Une proposition captivante qui, grâce à la combinaison des teintes, met également en valeur les formes et les volumes, pour un résultat absolument appréciable.

- 01 Le mensole SLAB, possono contare su una serie di pensili dedicati, che creano un effetto ad incastro nell'insieme. / SLAB shelves have a series of dedicated wall units, which create an interlocking effect in the whole. / Les étagères SLAB, peuvent compter sur une série de placards muraux dédiées, qui créent un effet d'emboîtement dans l'ensemble.
- 02 La versione della lampada MERIDIAN dedicata allo specchio BASIC, si sposa perfettamente con la versione nero opaco di quest'ultimo (cod. SP920). / The version of the MERIDIAN lamp dedicated to the BASIC mirror goes perfectly with the matt black version of the latter (cod. SP920). / La version de la lampe MERIDIAN dédiée au miroir BASIC se marie parfaitement avec la version Noire Mate de ce dernier (code SP920).
- 03 20 sono le finiture disponibili per i top in Gres, sia con finiture di pietra naturale che materiali tecnici. / 20 finishes are available for stoneware tops, with both natural stone finishes and technical materials. / 20 finitions sont disponibles pour les plans en Grès, avec des finitions en pierre naturelle et des matériaux techniques.



187X Bourbon Oak



L007M Grigio Seta Opaco



GR05 Gres Calacatta

Vertigo. evolution

Questa nicchia illuminata è la cornice ideale per questa nostra proposta, dove i frontali cannettati spiccano sul rivestimento dal formato innovativo.

This illuminated niche is the ideal setting for this proposal of ours, where the fluted fronts stand out against the wall with its innovative tile format.

Cette niche éclairée est le cadre idéal pour notre proposition, où les façades cannelées se détachent du revêtement au format innovant.

COMP. VE 12







Come la nostra modularità risulta essere la più performante del mercato, anche gli elementi a giorno, sono sviluppati in tutte le soluzioni e permettono ampio margine creativo ai progettisti. >

As our modularity is the best performing on the market, the open elements, too, are developed in all solutions and allow designers ample creative scope.

Comme notre modularité s'avère être la meilleure du marché, les éléments ouverts sont eux aussi développés dans toutes les solutions et laissent aux décorateurs une grande marge de manœuvre créative.

< In questa vista dall'alto, si apprezza pienamente la funzione degli elementi di raccordo per le profondità, che possono essere utilizzati per fruire di spazi altrimenti ristretti o, come in questo caso, essere semplici moduli decorativi per composizioni meno banali.

In this view from above, one fully appreciates the function of the depth connection elements, which can be used to make use of otherwise confined spaces or, as in this case, be simple decorative modules for less mundane compositions.

Dans cette vue du haut, on peut apprécier pleinement la fonction des éléments de raccordement pour les profondeurs, qui peuvent être utilisés pour exploiter des espaces plus restreints ou, comme dans ce cas, être de simples modules décoratifs pour des compositions moins banales.





COMP. VE 12 VERTIGO EVOLUTION

Elementi diversi per creare giochi di volumi e spazi, per dare dinamismo alla composizione.

Different elements to create games of volumes and spaces, to give dynamism to the composition.

Des éléments différents pour créer des jeux de volume et d'espace, afin de donner du dynamisme à la composition.

- 01 La flessibilità progettuale delle nostre specchiere LUX su misura, permette di creare interessanti composizioni, enfatizzate a loro volta dalla cornice di luce che si crea. / The design flexibility of our made-to-measure LUX mirrors makes it possible to create interesting compositions, emphasised in turn by the frame of light that is created. / La flexibilité de conception de nos miroirs LUX sur mesure permet de créer des compositions intéressantes, soulignées à leur tour par le cadre lumineux qui se crée.
- 02 I cambi di profondità disponibili nella nostra proposta modulare, permettono di collegare elementi di diverse profondità, con un interessante proposta di elementi a giorno, molto utili per le cose di uso quotidiano. / The available depth of change elements in our modular proposal, allow units of different depths to be connected, with an interesting proposal of open spaces, very useful for everyday things. / Les changements de profondeur disponibles dans notre proposition modulaire permettent d'assembler des éléments de différentes profondeurs, avec une proposition intéressante d'éléments ouverts, très utiles pour les objets de la vie quotidienne.

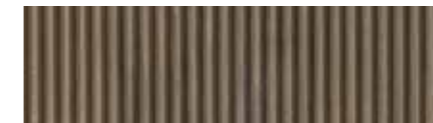

189X Fruit Wood



L061M Comodoro Opaco



Mineraltek L061M Comodoro Opaco

Vertigo. evolution

Una sorprendente capacità di stoccaggio per tutto il necessario del bagno, in questa composizione, che mantiene comunque in linea essenziale.

Surprising storage capacity for all bathroom necessities in this composition, which nonetheless maintains an essential shape.

Une capacité de rangement surprenante pour tout le nécessaire de la salle de bains dans cette composition qui conserve néanmoins une ligne essentielle.

.....
COMP. VE 13







Sopra. La finitura laccata rende ancor più evidente il gioco di chiaroscuro che si ottiene con l'effetto cannettato di Vertigo, notare anche i capaci cassettoni di questa soluzione.

Above. The lacquered finish makes the play of light and shade that is achieved with Vertigo's fluted effect even more evident, note also the capable drawers of this solution.

Ci-dessus. La finition laquée rend encore plus évident le jeu d'ombres et de lumières obtenu grâce à l'effet cannelé de Vertigo. À noter également les tiroirs spacieux de cette solution.

Questa inquadratura enfatizza la pulizia del design del lavabo dedicato alle base curve, un perfetto abbinamento per un mobile sorprendente.

This framing emphasises the clean design of the washbasin dedicated to the curved base, a perfect match for a striking piece of furniture.

La photo met en valeur le design épuré du lavabo dédié à la base incurvée, un accord parfait pour un meuble surprenant.





•01



•02

COMP. VE 13 VERTIGO EVOLUTION

Una curva lieve ed elegante raccorda le due parti di questa soluzione, in un seducente gioco di garbata signorilità.

A gentle and elegant curve connects the two parts of this solution, in a seductive play of gentle exclusivity.

Une courbe douce et élégante relie les deux parties de cette solution, dans un jeu séduisant d'élégance gracieuse.

- 01 Specchio BLACK, disponibile in svariate soluzioni, con o senza luce, a misure fisse e personalizzate. / BLACK mirror, available in a variety of solutions, with or without light, fixed and custom sizes. / Miroir BLACK, disponible en plusieurs solutions, avec ou sans lumière, en dimensions fixes et personnalisées.
- 02 Il progetto di Vertigo Evolution, è caratterizzato dal ricercato gioco delle sue gole, con le quali è possibile realizzare sia soluzione con gola tronca che passante. / The design of Vertigo Evolution, is characterised by the refined play of its grooves, with which it is possible to realise both truncated and through groove solutions. / Le projet de Vertigo Evolution se caractérise par le jeu raffiné de ses gorges, avec lesquelles il est possible de réaliser des solutions à gorge tronquée ou traversante.

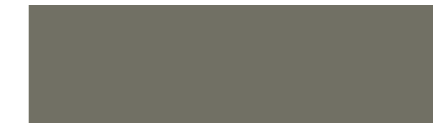

L016M Grigio Quarzo Opaco

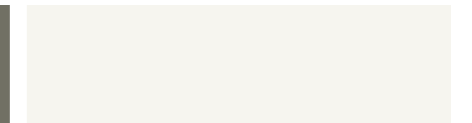

Ocritech Bianco Opaco

Vertigo. evolution

Calde ed accoglienti atmosfere per una composizione a doppio lavabo, sviluppata sulle nuove basi curve di Vertigo Evolution, che unite, creano un morbido arco di sicuro effetto, senza pregiudicare la capacità contenitiva del mobile.

Warm and cosy atmospheres for a double washbasin composition, developed on the new curved Vertigo Evolution base units, which together create a soft arc of great effect, without compromising the storage capacity of the cabinet.

Ambiances chaleureuses et accueillantes pour une composition à double lavabo, qui se développe sur les nouveaux meubles bas courbes Vertigo Evolution, qui ensemble créent un arc doux de grand effet, sans compromettre la capacité de rangement du meuble.

COMP. VE 14







> In questa immagine, ancor meglio percepibile la linea elegante delle curve disegnate dalla nuova collezione Evolution, un must di raffinatezza ed esclusività.

In this image, the elegant line of the curves designed by the new Evolution collection, a must of refinement and exclusivity, is even better perceived.

Sur cette image, on perçoit encore mieux la ligne élégante des courbes dessinées par la nouvelle collection Evolution, un must de raffinement et d'exclusivité.

< Qui a lato, evidenziata la linea minimale della lampada DUAL, disponibile anche in Bianco Opaco, qui abbinata alla nuova finitura bianca, disponibile sugli specchi BASIC su misura. Interessante ed utile anche lo specchio ingranditore (3X) con attacco magnetico.

Highlighted here is the minimalist line of the DUAL lamp, with lighting on two sides, also available in matt white, here combined with the new white finish, available on the bespoke BASIC mirrors. The magnifying mirror (3X) with magnetic attachment is also interesting and useful.

Ci-contre, la ligne minimaliste de la lampe DUAL, disponible aussi en Blanc Mat, associée à la nouvelle finition blanche disponible sur les miroirs BASIC. Intéressant et utile aussi le miroir grossissant (3X) avec fixation magnétique.





COMP. VE 14 VERTIGO EVOLUTION

Essenziale e pulita, ma allo stesso tempo una composizione che esprime eleganza e calda accoglienza, per un bagno esclusivo destinato alla coppia.

Essential and clean, but at the same time a composition that expresses elegance and warm welcome, for an exclusive bathroom for couples.

Essentielle et propre, tout en étant une composition qui exprime l'élégance et l'accueil chaleureux, pour une salle de bains exclusive destinée au couple.

- 01 Lampada DUAL abbinata alla nuova esclusiva versione in Bianco Opaco degli specchi BASIC, disponibili in opzione nella versione "su misura". / DUAL lamp combined with the new exclusive matt white version of the BASIC mirrors. / Lampe DUAL associée à la nouvelle version exclusive Blanc Mat des miroirs BASIC, disponibles en option dans la version "sur mesure".
- 02 Specchio ingranditore con fattore x3 con attacco magnetico su piastra metallica di libera installazione sui nostri specchi a muro. / Magnifying mirror with x3 factor with magnetic attachment on metal plate for free installation on our wall mirrors. / Miroir grossissant avec facteur x3 avec fixation magnétique sur plaque métallique pour une installation libre sur nos miroirs muraux.
- 03 Il piano in Ocritech di questa composizione, presenta la nuova vasca dedicata alle basi curve, delle quali segue il profilo. Lo scarico invisibile ma ispezionabile, contribuisce alla pulizia estetica dell'insieme. / The Ocritech top of this composition features the new basin dedicated to the curved base units, whose profile it follows. The invisible but inspectionable drain contributes to the aesthetic cleanliness of the whole. / Le plan en Ocritech de cette composition présente la nouvelle vasque dédiée aux meubles courbes, dont elle suit le profil. Le drain, invisible mais inspectable, contribue à la propreté esthétique de l'ensemble.



187X Bourbon Oak

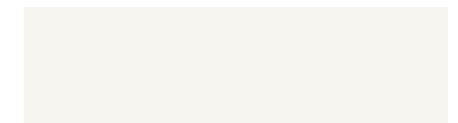

Ocritech Bianco Opaco



PIANTOTTE

0118

COLLEZIONE VERTIGO EVOLUTION

V.

LE FINITURE
FINISHES
FINITIONS

Vertigo. evolution

Polimerici Legno.



187X BURBON OAK



188X THERMO A



186X DARK ROCKFORD



183X ROVERE GRAIN



189X FRUIT WOOD

Finiture Laccato opaco. Matt lacquer finishes Couleurs laquées mates

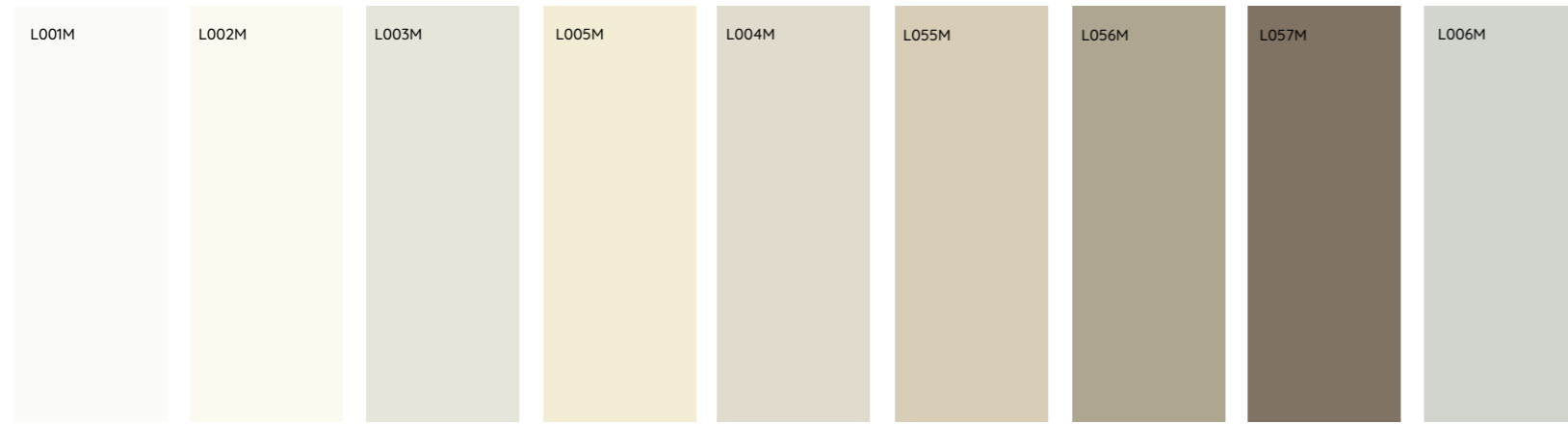

L001M BIANCO BASE / BASE WHITE / BLANC DE BASE
 L002M BIANCO PURO / PURE WHITE / BLANC PUR
 L003M BIANCO GRIGIO / WHITE GREY / BLANC GRIS
 L005M BIANCO PERLA / OYSTER WHITE / BLANC PERLE
 L004M PERGAMENA / PERGAMON / PERGAMON
 L005M SAHARA / SAHARA / SAHARA
 L006M ARGILLA / CLAY / ARGILE
 L007M TALPA / MOLE / TAUPE
 L006M GRIGIO LUCE / LIGHT GREY / GRIS LUMIÈRE

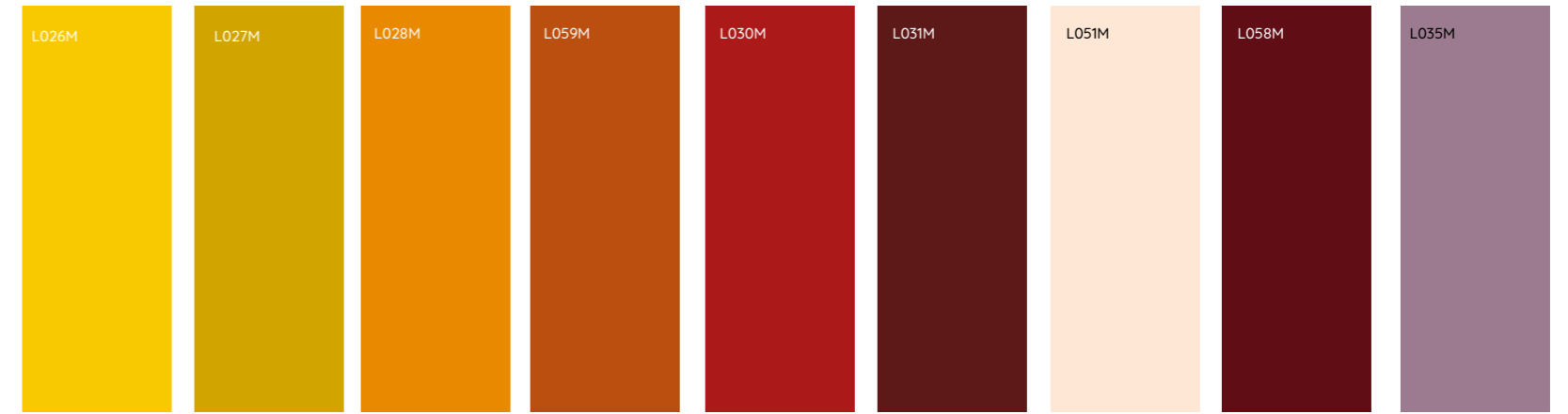

L026M GIALLO CADMIO / RAPE YELLOW / JAUNE COLZA
 L027M GIALLO MIELE / HONEY YELLOW / JUAUNE MIEL
 L028M ARANCIO GIALLO / YELLOW ORANGE / ORANGÉ JAUNE
 L059M MINIO / MINIO / MINIO
 L030M ROSSO SEGNALE / SIGNAL RED / ROUGE DE SÉCURITÉ
 L031M ROSSO PORPORA / PURPLE RED / ROUGE POURPRE
 L051M CIPRIA / POWDER PINK / POUDRE
 L058M JAPUR / JAPUR / JAPUR
 L035M VIOLETTO PASTELLO / PASTEL VIOLET / VIOLET PASTEL



L007M GRIGIO SETA / SILK GREY / GRIS SOIE
 L008M GRIGIO SILICEO / PEBBLE GREY / GRIS SILEX
 L009M GRIGIO AGATA / AGATE GREY / GRIS AGATE
 L010M GRIGIO PLATINO / PATINUM GREY / GRIS PLATINE
 L011M GRIGIO SEGNALE / SIGNAL GREY / GRIS DE SÉCURITÉ
 L012M GRIGIO POLVERE / DUSTY GREY / GRIS POUSSIÈRE
 L013M GRIGIO PIETRA / STONE GREY / GRIS PIERRE
 L014M GRIGIO CALCESTRUZZO / CONCRETE GREY / GRIS BÉTON
 L015M GRIGIO TOPO / MOUSE GREY / GRIS SOURIS

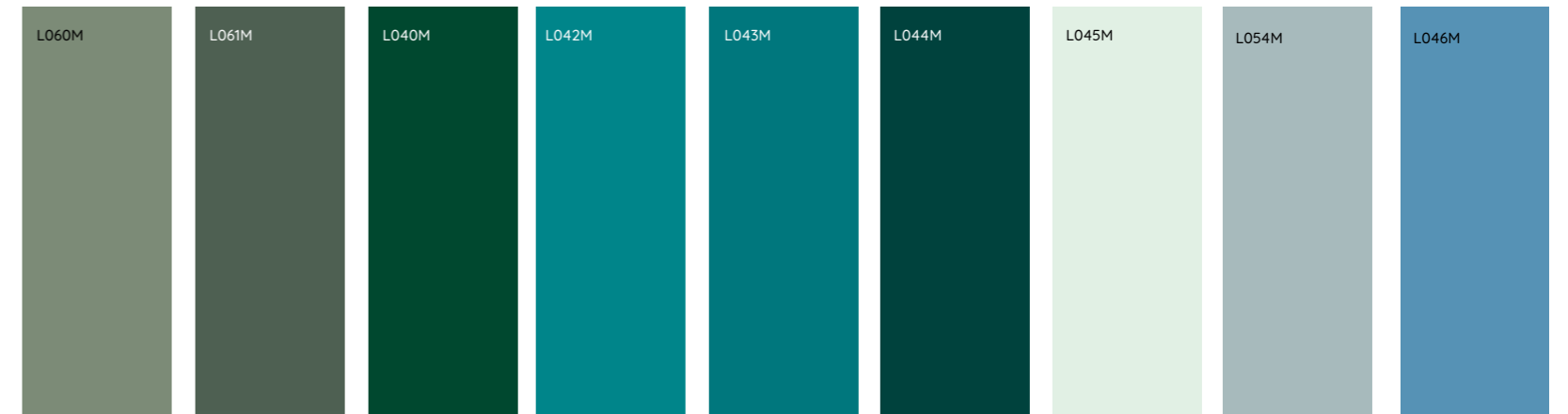

L060M VERDE SALVIA / SAGE GREEN / VERT SALVAGE
 L061M COMODORO / COMODORO / COMODORO
 L040M VERDE MUSCHIO / MOSS GREEN / VERT MOUSSE
 L042M BLU TURCHESE / TURQUOISE BLUE / BLEU TURQUOISE
 L043M BLU ACQUA / WATER BLUE / BLEU D'EAU
 L044M VERDE BLU / BLUE GREEN / VERT BLEU
 L045M AZZURRO TENUE / LIGHT AZURE / AZUR PÂLE
 L054M BRUMA / MIST / BROUILLARD
 L046M BLU PASTELLO / PASTEL BLUE / BLEU PASTEL



L016M GRIGIO QUARZO / QUARTZ GREY / GRIS QUARTZ
 L017M GRIGIO BLU / BLUE GREY / GRIS BLEU
 L018M GRIGIO BASALTO / BASALT GREY / GRIS BASALTE
 L019M GRIGIO GRAFITE / GRAPHITE GREY / GRIS GRAPHITE
 L021M BEIGE TERRA / TERRA BEIGE / BEIGE TERRA
 L022M BEIGE GRIGIASTRO / GREY BEIGE / BEIGE GRIS
 L023M GRIGIO BEIGE / BEIGE GREY / GRIS BEIGE
 L024M MARRONE TERRA / TERRA BROWN / BRUN TERRE
 L025M MARRONE GRIGIO / GREY BROWN / BRUN GRIS

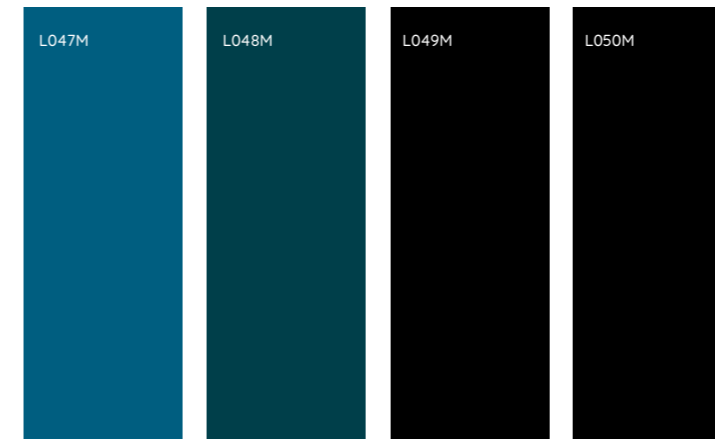

L047M BLU AZZURRO / AZURE BLUE / BLEU AZUR
 L048M BLU OCEANO / OCEAN BLUE / BLEU OCEAN
 L049M NERO GRAFITE / GRAPHITE BLACK / NOIR GRAPHITE
 L050M NERO PROFONDO / DEEP BLACK / NOIR FONCÉ

Abbinamenti consigliati.

Suggested Combinations Associations recommandées



A - Polimerico 188X Thermo A
 B - laccato opaco L007M Silk grey
 C - Gres GR16 Pietra Iseo
 D - metallo ossido

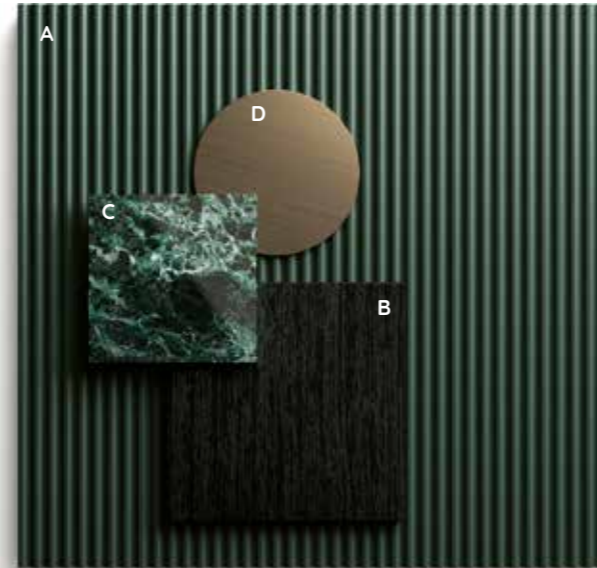

A - laccato opaco L061 Comodoro
 B - Melaminico 131X Legno Carbone U12 (liscio)
 C - Gres GR24 verde alpi lucido
 D - metallo ottone patinato



A - Polimerico 187X Burbon Oak
 B - laccato opaco L025M Grey brown
 C - Gres GR05 Calacatta Matt
 D - metallo brown

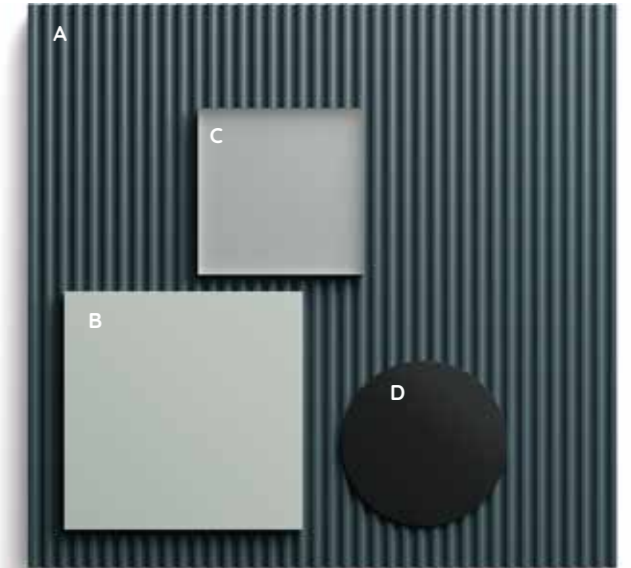

A - laccato opaco L017M Blue grey
 B - laccato opaco L006M Light grey
 C - vetro satinato LIGHT GREY RAL7035
 D - metallo nero



A - Polimerico 183X Rovere Grain
 B - laccato opaco L054M Bruma
 C - ochritech OC01 Matt White
 D - metallo nero

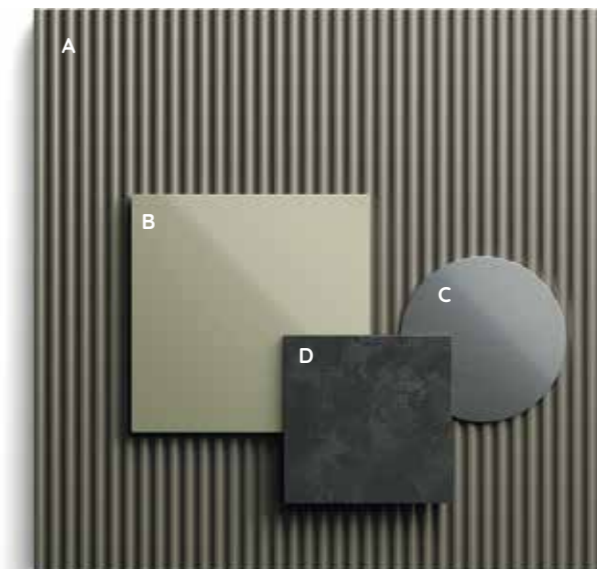

A - laccato opaco L016M Quartz grey
 B - laccato lucido L008G Pebble grey
 C - HPL H011 Ossido 0545
 D - metallo nikel

Elenco composizioni.

Compositions' list | Liste des compositions

PUNTOTRE

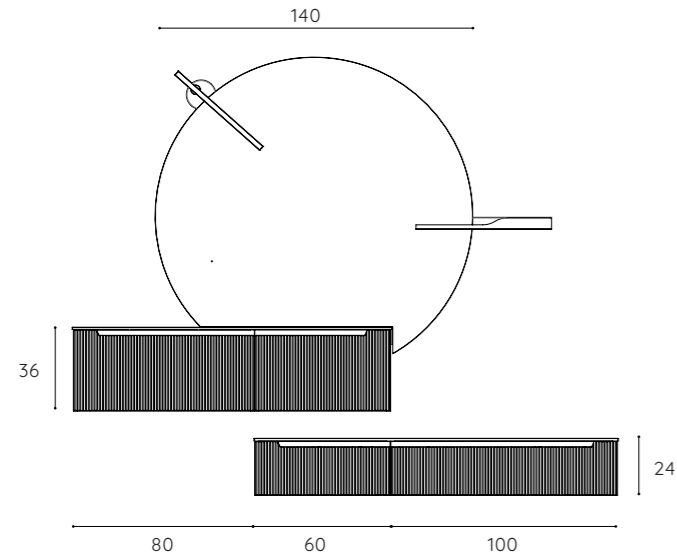

Composizione VE 01 | Pag. 06/13

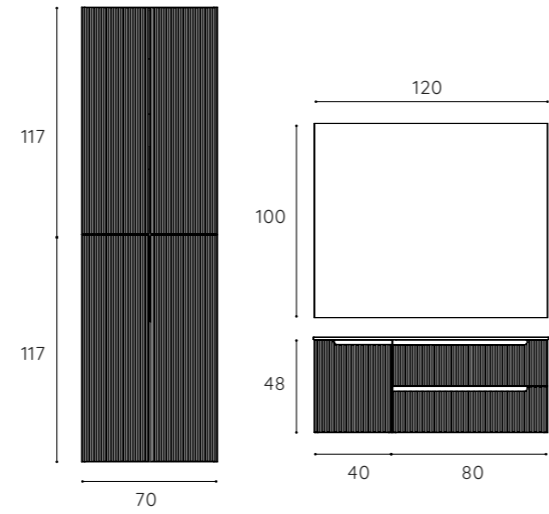

Composizione VE 02 | Pag. 14/21

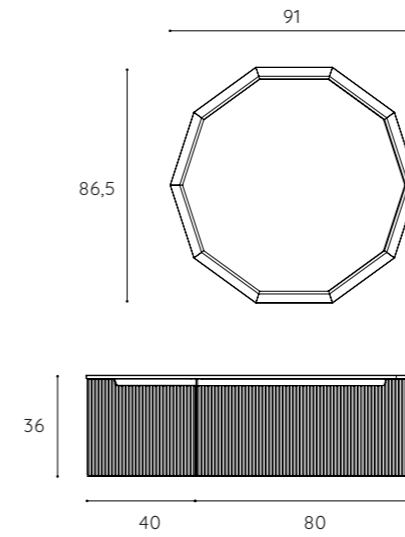

Composizione VE 05 | Pag. 38/45

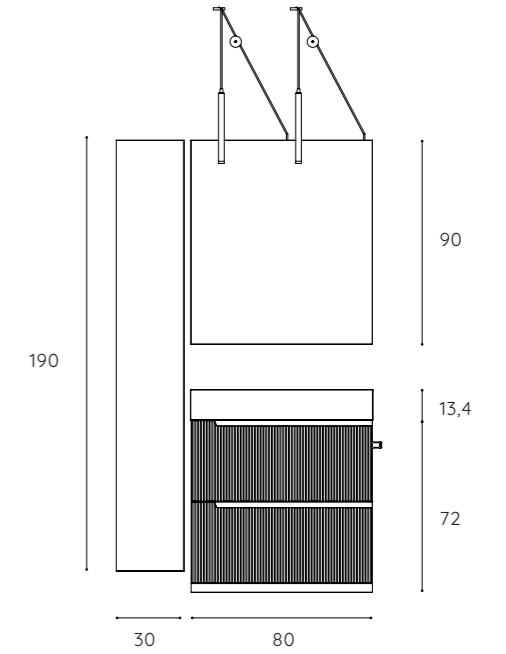

Composizione VE 06 | Pag. 46/53

COLLEZIONE VERTIGO EVOLUTION 0124

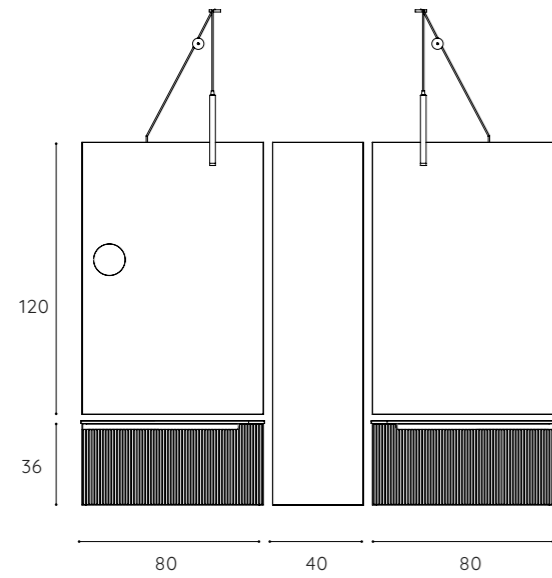

Composizione VE 03 | Pag. 22/29

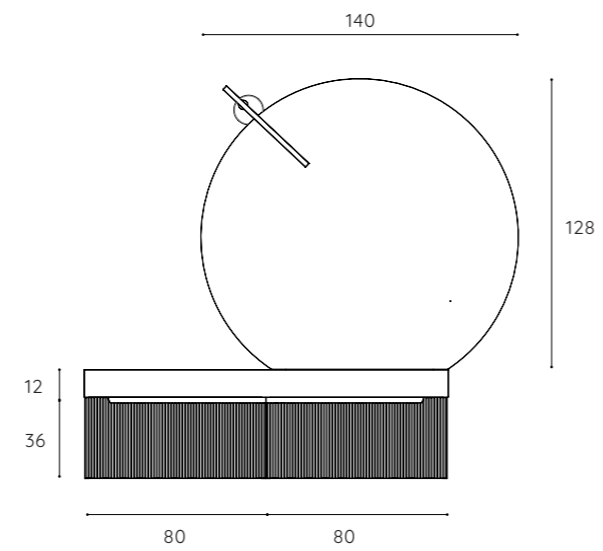

Composizione VE 04 | Pag. 30/37

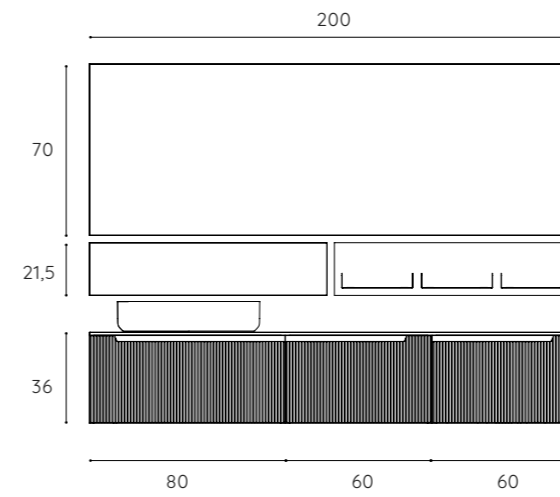

Composizione VE 07 | Pag. 54/61

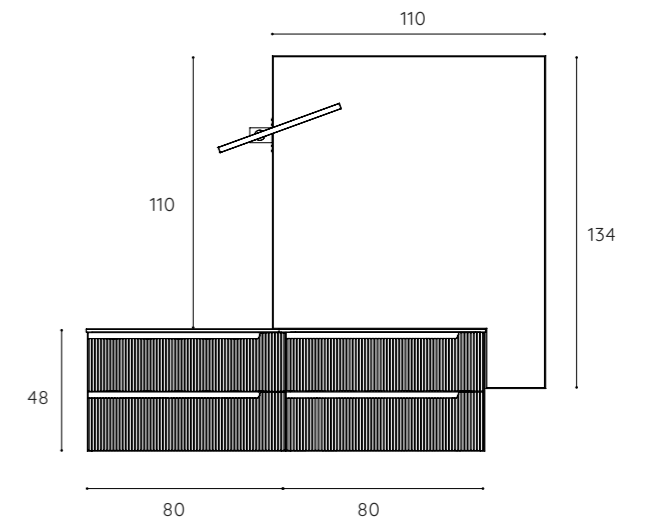

Composizione VE 08 | Pag. 62/69

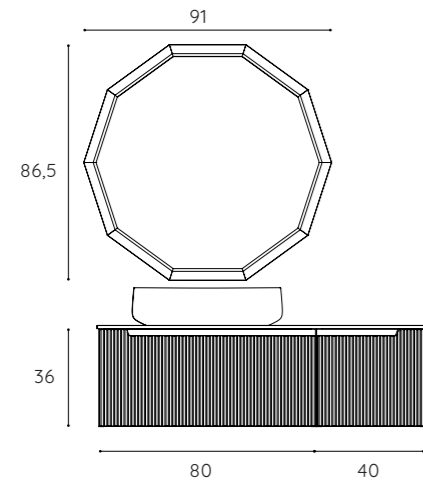

Composizione
VE 09 | Pag.
70/77

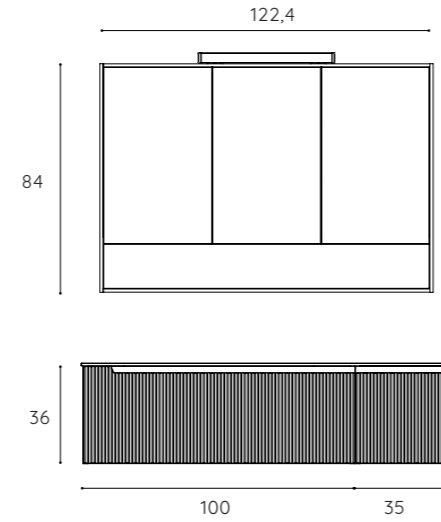

Composizione
VE 10 | Pag.
78/85

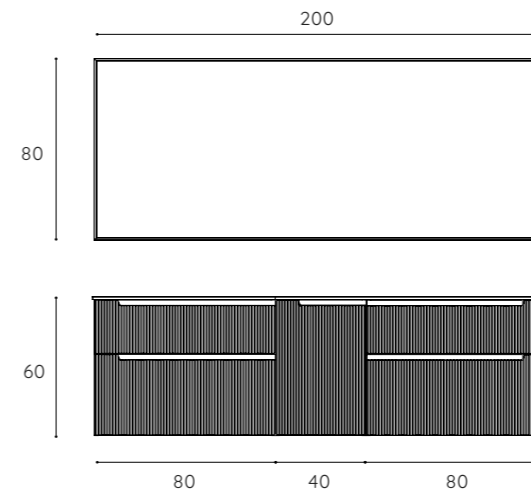

Composizione
VE 13 | Pag.
102/109

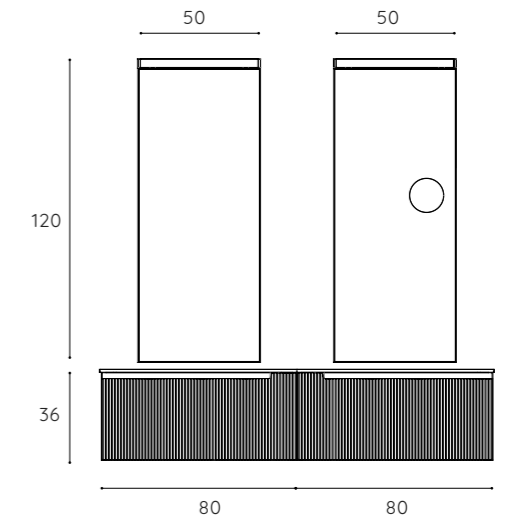

Composizione
VE 14 | Pag.
110/117

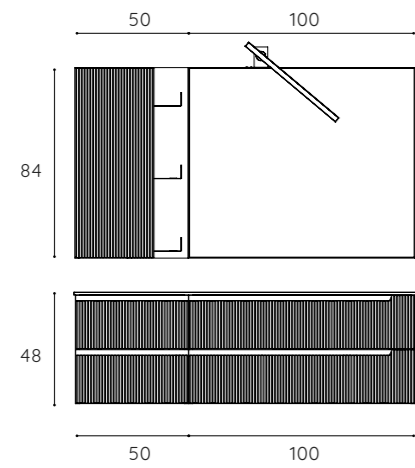

Composizione
VE 11 | Pag.
86/93

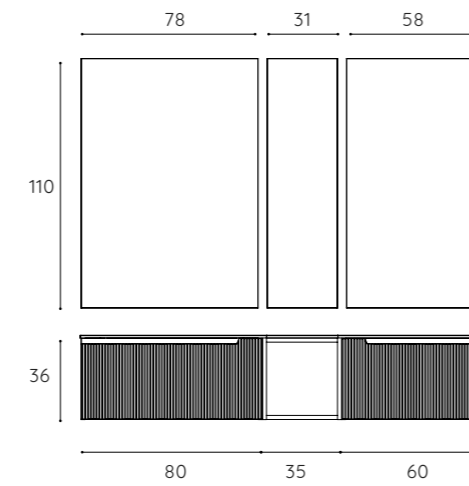

Composizione
VE 12 | Pag.
94/101

PUNTOTRE ARREDOBAGNO

Strada San Giovanni di Livenza, 19/G

33077 Sacile (PN) · Italy

Tel. +39 0434 768210

Fax +39 0434 768202

www.puntotre.com

info@puntotre.com

Credits

Project

Puntotre

Concept e art direction

Willy Dalto

Set design e styling

Nicola Barutto

Graphic design

Federica Mattietto

Images

Inthemiddle studio

Printing

Grafiche Italprint

THANKS TO

Jaquar World

Geda Nextage

Fima Frattini

Nicos International

www.puntotre.com