

# NAXANI

**2023** HOME COLLECTION

# INDEX

ARTIK	42
ALPE	14
BAXE	22
BERDER	02
CALMA	06
CLIFT	28
FEMTY	26
KIBELL	18
LENOX	38
TIMBER	32
ESPEJOS/ MIROIRS / MIRRORS	44
ILUMINACIÓN / ÉCLAIRAGE / LIGHTING	44

# BERDER



BERDER 120 [091] ■ KOLO 120 ■ RADIAL 120 ■ ODET



BERDER 100 [027] ■ CIRCLE ■ RADIAL 100 ■ DEVA



BERDER 100 [027] ■ CIRCLE



BERDER 100 [027] ■ LAO 100



# BERDER

MEDIDAS | MESURES | MEASUREMENTS

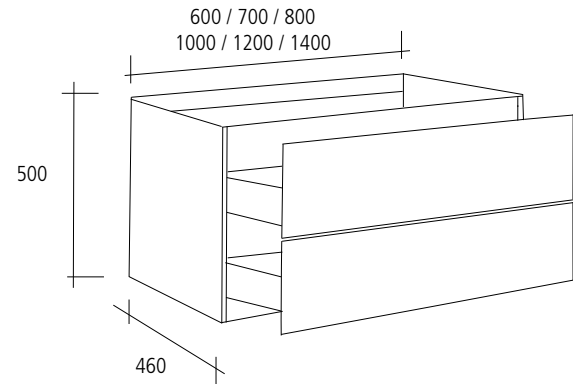

• Tableros PEFC con bajo contenido en formaldehído, según NORMA EU E1 y EE UU CARB2.

• Panneaux (agglomérés ou mdf) PEFC à faible teneur en formaldéhyde, selon la NORME EUROPÉENNE CLASSE E1 et AMÉRICAINNE CARB2.

• PEFC low formaldehyde content boards, conforming to STANDARDS EU E1 and EEUU CARB2.

ACABADOS | FINITIONS | FINISHES

Lacado satinado | Laques satinées | Silk lacquered



MATERIALES | MATÉRIELS | MATERIALS

ESTRUCTURA   STRUCTURE   STRUCTURE	FRENTE   FAÇADES   FRONTS			LATERALES   CÔTÉS   SIDES		
AGLOMERADO 16 MM AGGLOMÉRÉ 16 MM 16 MM CHIPBOARD	AGLOMERADO 16 MM AGGLOMÉRÉ 16 MM 16 MM CHIPBOARD	MDF HIDRÓFUGO 16 MM MDF HYDRÓFUGE 16 MM MOISTURE RESISTANT 16 MM MDF	MADERA MACIZA 21 MM BOIS MASSIF 21 MM 21 MM SOLID TIMBER	AGLOMERADO 16 MM AGGLOMÉRÉ 16 MM 16 MM CHIPBOARD	MDF 10 MM	MADERA MACIZA 21 MM BOIS MASSIF 21 MM 21 MM SOLID TIMBER
✓		✓		✓		
CAJONES EXTRACCIÓN TOTAL TIROIR OUVERTURE TOTALE FULL EXTENSION DRAWERS	CAJÓN CIERRE SILENCIOSO TIROIR FERMETURE EN DOUCEUR SOFT CLOSE DRAWER	PUERTA CIERRE SILENCIOSO CHARNIÈRES AVEC FREIN SOFT CLOSE DOOR	CAJONES "PUSH" TIROIRS "PUSH" PUSH DRAWERS	HUECO TUBERÍAS VIDE SANITAIRE SERVICE SPACE		
✓	✓			✓		

• CAJÓN METÁLICO DE CIERRE SILENCIOSO, APERTURA TOTAL Y CAPACIDAD DE CARGA DE 40 KG.  
TIROIR AVEC CÔTÉS MÉTALLIQUES, TIROIR FERMETURE EN DOUCEUR, À OUVERTURE TOTALE ET CAPACITÉ DE CHARGE 40 KG.  
METAL SIDED SOFT CLOSE DRAWER, FULL EXTENSION WITH 40 KG CAPACITY.

• COLGADOR DE ALTA RESISTENCIA, REGULABLE, CON CARGA MÁXIMA 65KG/ UNIDAD SEGÚN DIN 68840, CERTIFICADO LGA.  
FIXATIONS MURALES DE HAUTE RÉSIDENCE, RÉGLABLES, CHARGE MAXI 65KG/UNITÉ, SELON DIN 68840, CERTIFIÉ LGA.  
ADJUSTABLE WALL HANGER WITH HIGH CAPACITY OF 65 KG, CONFORMING TO STANDARDS DIN 68840, LGA CERTIFIED.

# BERDER

LAVABOS | PLAN VASQUES | WASHBASINS

• MATERIAL: solid surface acrílico • MATIÈRE: solid surface acrylique • MATERIAL: acrylic solid surface

LAO

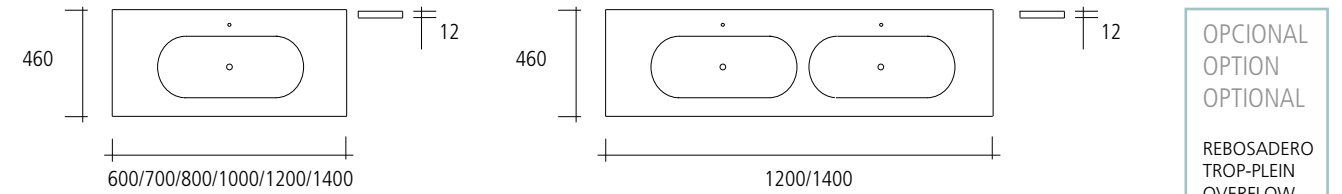

KOLO

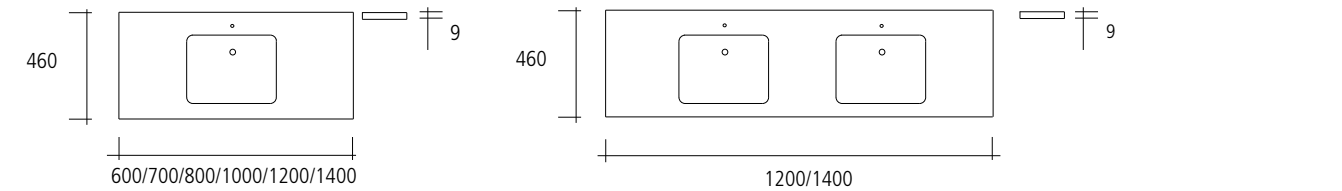

DARITO

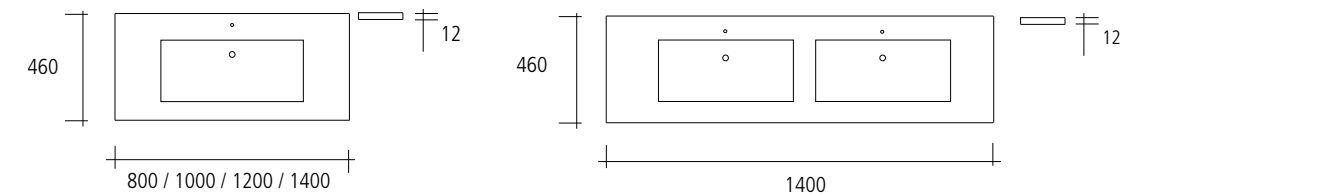

• MATERIAL: cerámica • MATIÈRE: céramique • MATERIAL: ceramic

CAMBRILS

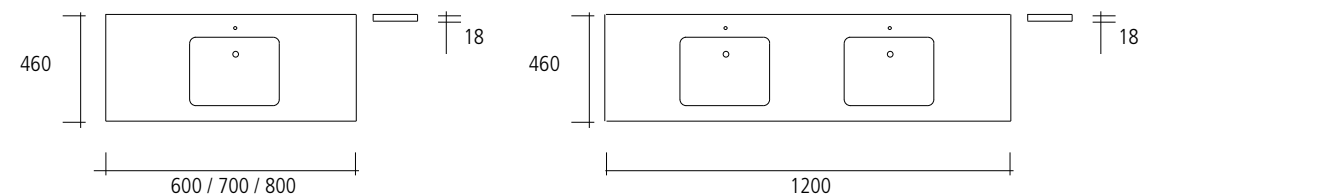

CIRCLE

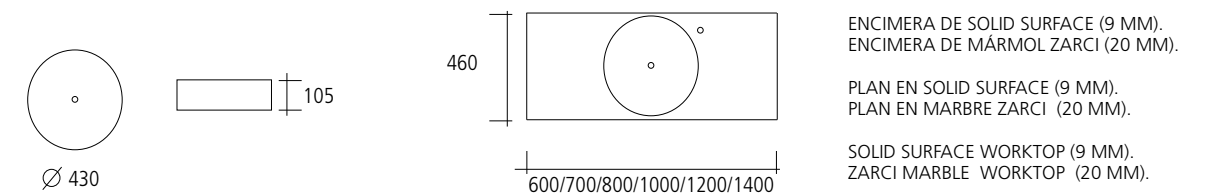

# CALMA



CALMA 100 [014 + BRASS] ■ CIRCLE ■ MÁRMOL ZARCI ■ RADIO 100 ■ DEVA

# CALMA



BLACK



INOX



BRASS

# CALMA



CALMA 100 [042 + BLACK] ■ KOLO 100 ■ ISI 100 ■ DEVA



CALMA 100 [042 + BLACK] ■ KOLO 100

# CALMA

MEDIDAS | MESURES | MEASUREMENTS

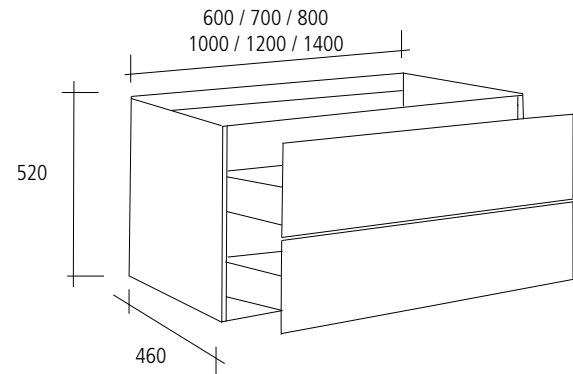

• Tableros PEFC con bajo contenido en formaldehído, según NORMA EU E1 y EE UU CARB2.

• Panneaux (agglomérés ou mdf) PEFC à faible teneur en formaldéhyde, selon la NORME EUROPÉENNE CLASSE E1 et AMÉRICAINNE CARB2.

• PEFC low formaldehyde content boards, conforming to STANDARDS EU E1 and EEUU CARB2.

## ACABADOS | FINITIONS | FINISHES

Lacado satinado | Laques satinées | Silk lacquered



Melaminado | Mé laminé | Melamine

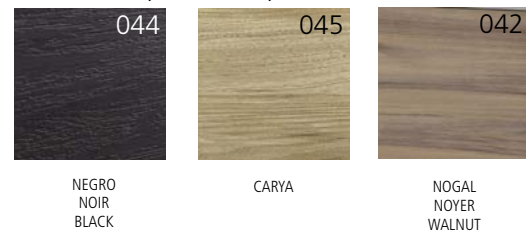

Asas | Poignées | Handles



## MATERIALES | MATÉRIELS | MATERIALS

ESTRUCTURA   STRUCTURE   STRUCTURE	FRENTES   FAÇADES   FRONTS			LATERALES   CÔTÉS   SIDES		
AGLOMERADO 16 MM AGGLOMÉRÉ 16 MM 16 MM CHIPBOARD	AGLOMERADO 16 MM AGGLOMÉRÉ 16 MM 16 MM CHIPBOARD	MDF HIDRÓFUGO 16 MM MDF HYDRÓFUGE 16 MM MOISTURE RESISTANT 16 MM MDF	MADERA MACIZA 21 MM BOIS MASSIF 21 MM 21 MM SOLID TIMBER	AGLOMERADO 16 MM AGGLOMÉRÉ 16 MM 16 MM CHIPBOARD	MDF 10 MM	MADERA MACIZA 21 MM BOIS MASSIF 21 MM 21 MM SOLID TIMBER
✓	✓	✓		✓		
CAJONES EXTRACCIÓN TOTAL TIROIR OUVERTURE TOTALE FULL EXTENSION DRAWERS	CAJÓN CIERRE SILENCIOSO TIROIR FERMETURE EN DOUCEUR SOFT CLOSE DRAWER	PUERTA CIERRE SILENCIOSO CHARNIÈRES AVEC FREIN SOFT CLOSE DOOR	CAJONES "PUSH" TIROIRS "PUSH" PUSH DRAWERS	HUECO TUBERÍAS VIDE SANITAIRE SERVICE SPACE		
✓	✓			✓		

• CAJÓN METÁLICO DE CIERRE SILENCIOSO, APERTURA TOTAL Y CAPACIDAD DE CARGA DE 40 KG.  
TIROIR AVEC CÔTÉS MÉTALLIQUES, TIROIR FERMETURE EN DOUCEUR, À OUVERTURE TOTALE ET CAPACITÉ DE CHARGE 40 KG.  
METAL SIDED SOFT CLOSE DRAWER, FULL EXTENSION WITH 40 KG CAPACITY.

• COLGADOR DE ALTA RESISTENCIA, REGULABLE, CON CARGA MÁXIMA 65KG/ UNIDAD SEGÚN DIN 68840, CERTIFICADO LGA.  
FIXATIONS MURALES DE HAUTE RÉ SISTANCE, RÉ GLABLES, CHARGE MAXI 65KG/UNITÉ, SELON DIN 68840, CERTIFIÉ LGA.  
ADJUSTABLE WALL HANGER WITH HIGH CAPACITY OF 65 KG, CONFORMING TO STANDARDS DIN 68840, LGA CERTIFIED.

# CALMA

LAVABOS | PLAN VASQUES | WASHBASINS

• MATERIAL: solid surface acrílico • MATIÈRE: solid surface acrylique • MATERIAL: acrylic solid surface

LAO

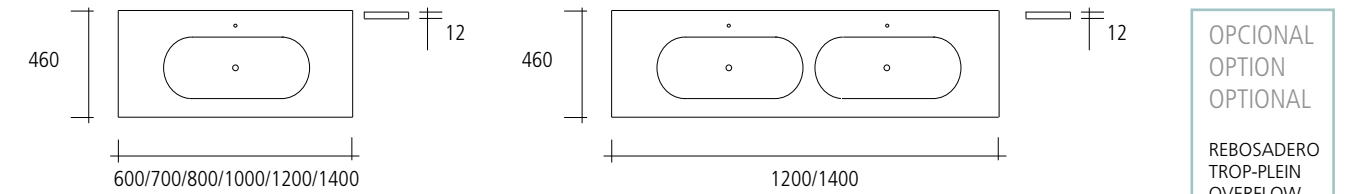

KOLO

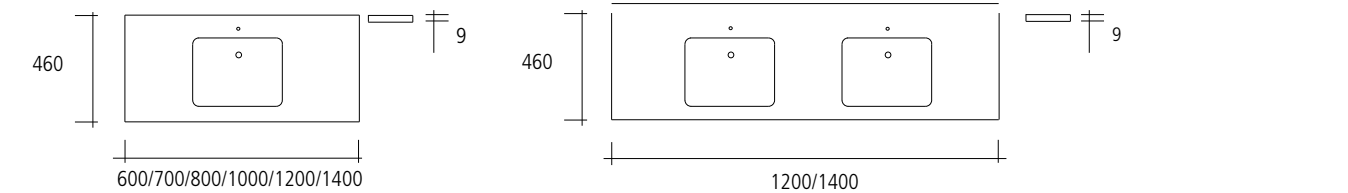

DARITO

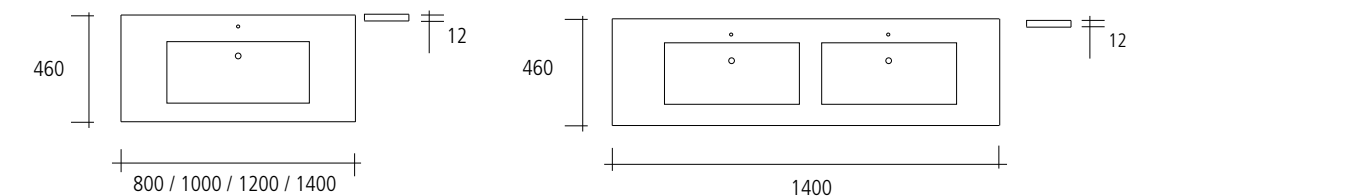

• MATERIAL: cerámica • MATIÈRE: céramique • MATERIAL: ceramic

CAMBRILS

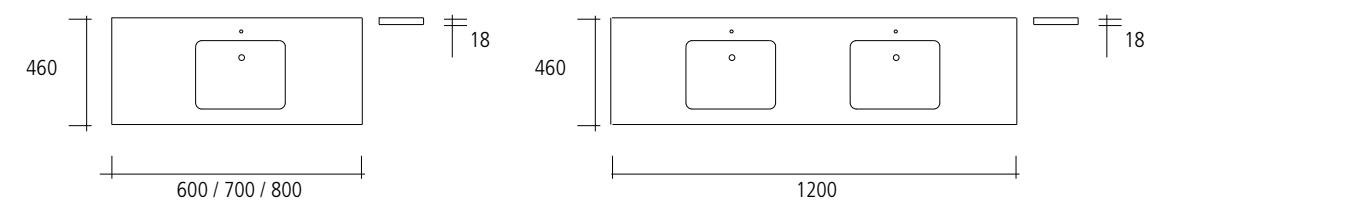

CIRCLE

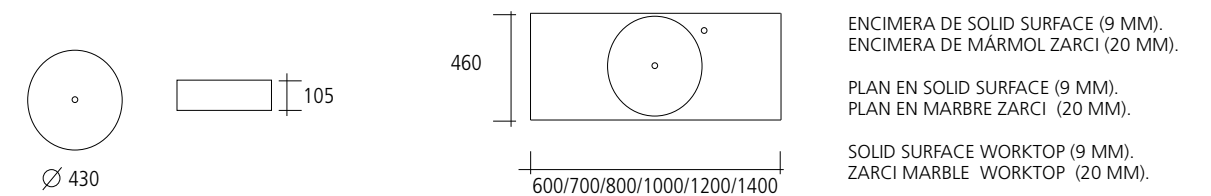

ENCIMERA DE SOLID SURFACE (9 MM).  
ENCIMERA DE MÁRMOL ZARCI (20 MM).

PLAN EN SOLID SURFACE (9 MM).  
PLAN EN MARBRE ZARCI (20 MM).

SOLID SURFACE WORKTOP (9 MM).  
ZARCI MARBLE WORKTOP (20 MM).



# ALPE



ALPE 80 [058] • CAMBRILS 80 • ISI 80 • DEVA



# ALPE

MEDIDAS | MESURES | MEASUREMENTS

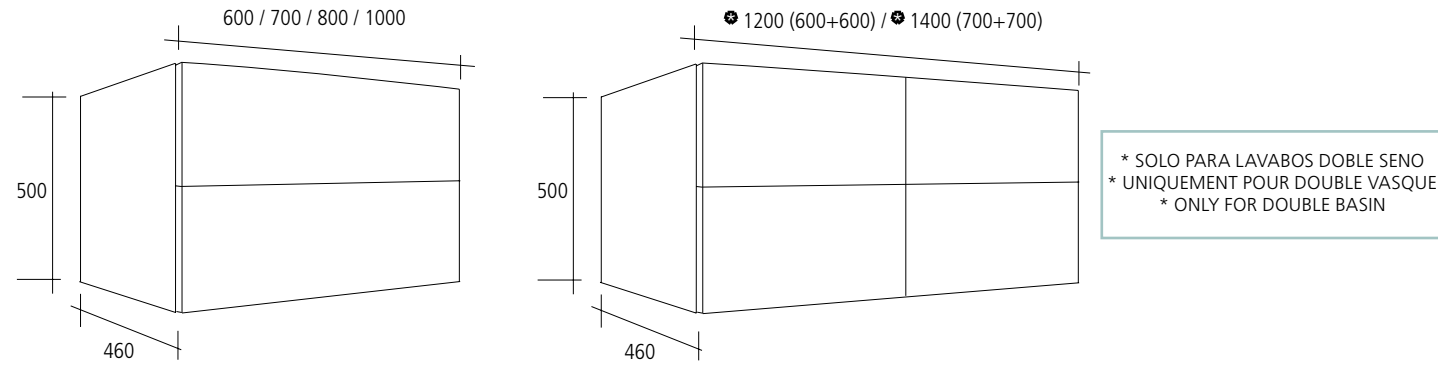

ACABADOS | FINITIONS | FINISHES

Madera maciza | Bois massif | Solid wood

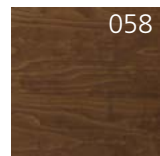

MADERA TINTADA  
BOIS TINTÉ  
STAINED TIMBER

- MUEBLE EN MADERA MACIZA TINTADA
- MEUBLE EN BOIS MASSIF TENTÉ.
- SOLID SATAINED TIMBER VANITY.

MATERIALES | MATÉRIELS | MATERIALS

ESTRUCTURA   STRUCTURE   STRUCTURE	FRENTE   FAÇADES   FRONTS			LATERALES   CÔTÉS   SIDES		
MADERA MACIZA 21 MM BOIS MASSIF 21 MM 21 MM SOLID TIMBER	AGLOMERADO 16 MM AGGLOMÉRÉ 16 MM 16 MM CHIPBOARD	MDF HIDRÓFUGO 16 MM MDF HYDROFUGE 16 MM MOISTURE RESISTANT 16 MM MDF	MADERA MACIZA 21 MM BOIS MASSIF 21 MM 21 MM SOLID TIMBER	AGLOMERADO 16 MM AGGLOMÉRÉ 16 MM 16 MM CHIPBOARD	MDF 10 MM	MADERA MACIZA 21 MM BOIS MASSIF 21 MM 21 MM SOLID TIMBER
✓			✓			✓
CAJONES EXTRACCIÓN TOTAL TIROIR OUVERTURE TOTALE FULL EXTENSION DRAWERS	CAJÓN CIERRE SILENCIOSO TIROIR FERMETURE EN DOUCEUR SOFT CLOSE DRAWER	PUERTA CIERRE SILENCIOSO CHARNIÈRES AVEC FREIN SOFT CLOSE DOOR	CAJONES "PUSH" TIROIRS "PUSH" PUSH DRAWERS	HUECO TUBERÍAS VIDE SANITAIRE SERVICE SPACE		
✓	✓			✓		

• CAJÓN METÁLICO DE CIERRE SILENCIOSO, APERTURA TOTAL Y CAPACIDAD DE CARGA DE 40 KG.  
TIROIR AVEC CÔTÉS MÉTALLIQUES, TIROIR FERMETURE EN DOUCEUR, À OUVERTURE TOTALE ET CAPACITÉ DE CHARGE 40 KG.  
METAL SIDED SOFT CLOSE DRAWER, FULL EXTENSION WITH 40 KG CAPACITY.

• COLGADOR DE ALTA RESISTENCIA, REGULABLE, CON CARGA MÁXIMA 65KG/ UNIDAD SEGÚN DIN 68840, CERTIFICADO LGA.  
FIXATIONS MURALES DE HAUTE RÉSIDANCE, RÉGLABLES, CHARGE MAXI 65KG/UNITÉ, SELON DIN 68840, CERTIFIÉ LGA.  
ADJUSTABLE WALL HANGER WITH HIGH CAPACITY OF 65 KG, CONFORMING TO STANDARDS DIN 68840, LGA CERTIFIED.

# ALPE

LAVABOS | PLAN VASQUES | WASHBASINS

• MATERIAL: solid surface acrílico • MATIÈRE: solid surface acrylique • MATERIAL: acrylic solid surface

LAO

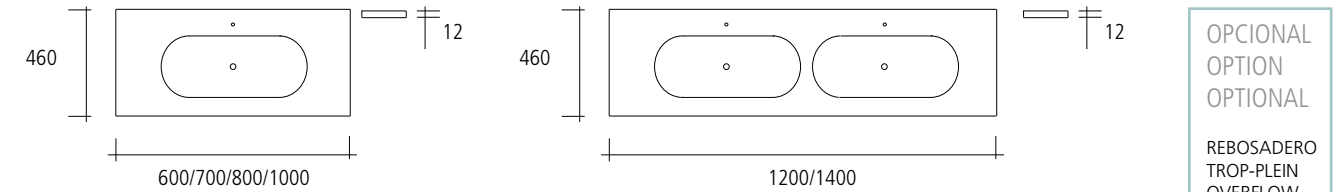

KOLO

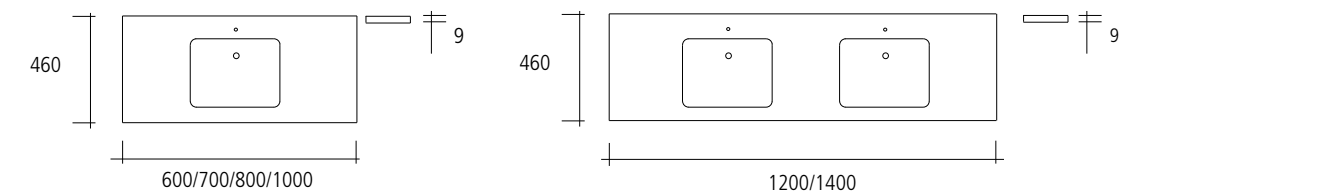

DARITO

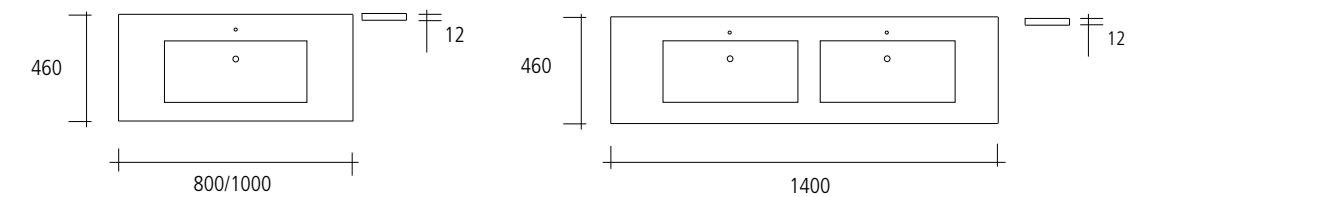

• MATERIAL: cerámica • MATIÈRE: céramique • MATERIAL: ceramic

CAMBRILS

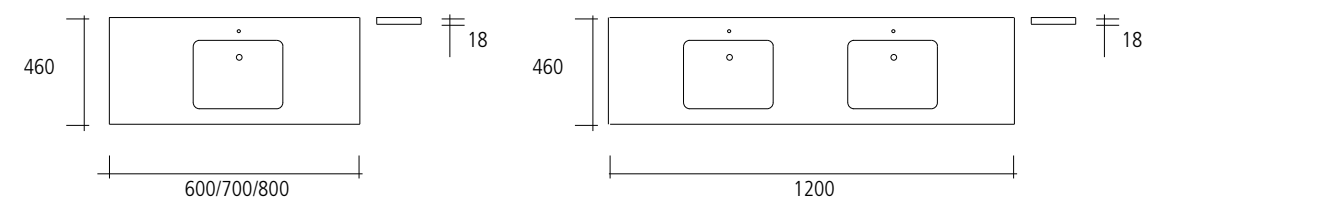

CIRCLE

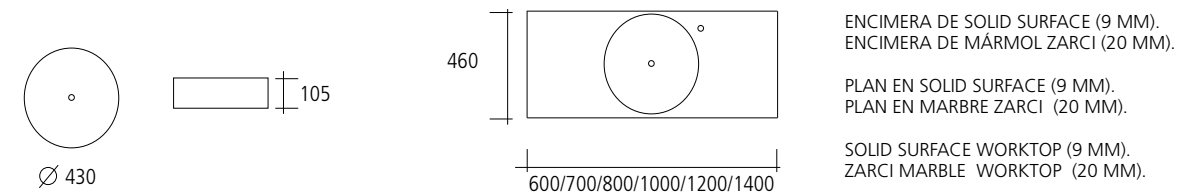

# KIBELL



KIBELL 100 [011] ■ DARITO 100 ■ ISI 100 ■ ODET XXL



# KIBELL

MEDIDAS | MESURES | MEASUREMENTS

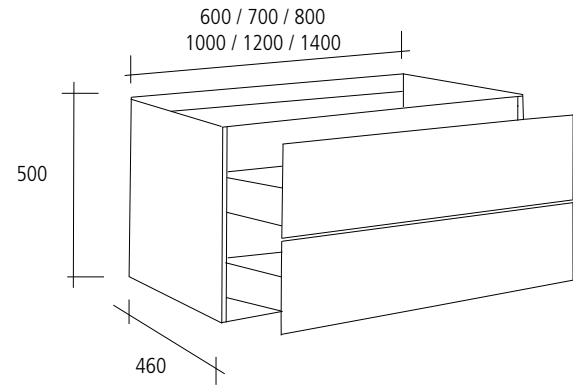

- Tableros PEFC con bajo contenido en formaldehído, según NORMA EU E1 y EE UU CARB2.
- Panneaux (agglomérés ou mdf) PEFC à faible teneur en formaldéhyde, selon la NORME EUROPÉENNE CLASSE E1 et AMÉRICAINNE CARB2.
- PEFC low formaldehyde content boards, conforming to STANDARDS EU E1 and EEUU CARB2.

## ACABADOS | FINITIONS | FINISHES

Lacado satinado | Laques satinées | Silk lacquered



## MATERIALES | MATÉRIELS | MATERIALS

ESTRUCTURA   STRUCTURE   STRUCTURE	FRENTE   FAÇADES   FRONTS			LATERALES   CÔTÉS   SIDES		
AGLOMERADO 16 MM AGGLOMÉRÉ 16 MM 16 MM CHIPBOARD	AGLOMERADO 16 MM AGGLOMÉRÉ 16 MM 16 MM CHIPBOARD	MDF HIDRÓFUGO 16 MM MDF HYDROFUGE 16 MM MOISTURE RESISTANT 16 MM MDF	MADERA MACIZA 21 MM BOIS MASSIF 21 MM 21 MM SOLID TIMBER	AGLOMERADO 16 MM AGGLOMÉRÉ 16 MM 16 MM CHIPBOARD	MDF 10 MM	MADERA MACIZA 21 MM BOIS MASSIF 21 MM 21 MM SOLID TIMBER
✓		✓			✓	
<b>CAJONES EXTRACCIÓN TOTAL TIROIR OUVERTURE TOTALE FULL EXTENSION DRAWERS</b>	<b>CAJÓN CIERRE SILENCIOSO TIROIR FERMETURE EN DOUCEUR SOFT CLOSE DRAWER</b>	<b>PUERTA CIERRE SILENCIOSO CHARNIÈRES AVEC FREIN SOFT CLOSE DOOR</b>	<b>CAJONES "PUSH" TIROIRS "PUSH" PUSH DRAWERS</b>	<b>HUECO TUBERÍAS VIDE SANITAIRE SERVICE SPACE</b>		
✓			✓	✓		

• CAJÓN METÁLICO DE CIERRE SILENCIOSO, APERTURA TOTAL Y CAPACIDAD DE CARGA DE 40 KG.  
TIROIR AVEC CÔTÉS MÉTALLIQUES, TIROIR FERMETURE EN DOUCEUR, À OUVERTURE TOTALE ET CAPACITÉ DE CHARGE 40 KG.  
METAL SIDED SOFT CLOSE DRAWER, FULL EXTENSION WITH 40 KG CAPACITY.

• COLGADOR DE ALTA RESISTENCIA, REGULABLE, CON CARGA MÁXIMA 65KG/ UNIDAD SEGÚN DIN 68840, CERTIFICADO LGA.  
FIXATIONS MURALES DE HAUTE RÉSIDENCE, RÉGLABLES, CHARGE MAXI 65KG/UNITÉ, SELON DIN 68840, CERTIFIÉ LGA.  
ADJUSTABLE WALL HANGER WITH HIGH CAPACITY OF 65 KG, CONFORMING TO STANDARDS DIN 68840, LGA CERTIFIED.

# KIBELL

LAVABOS | PLAN VASQUES | WASHBASINS

• MATERIAL: solid surface acrílico • MATIÈRE: solid surface acrylique • MATERIAL: acrylic solid surface

## LAO

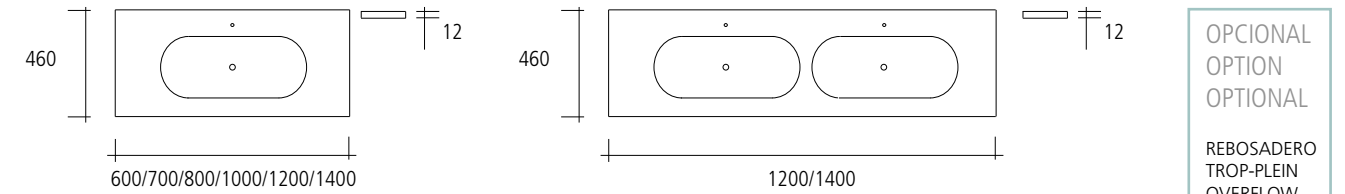

## KOLO

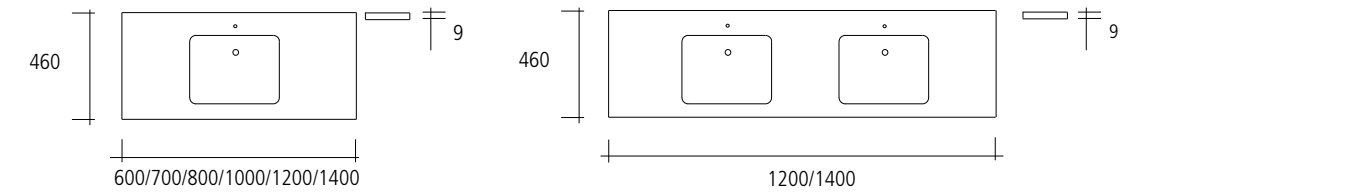

## DARITO

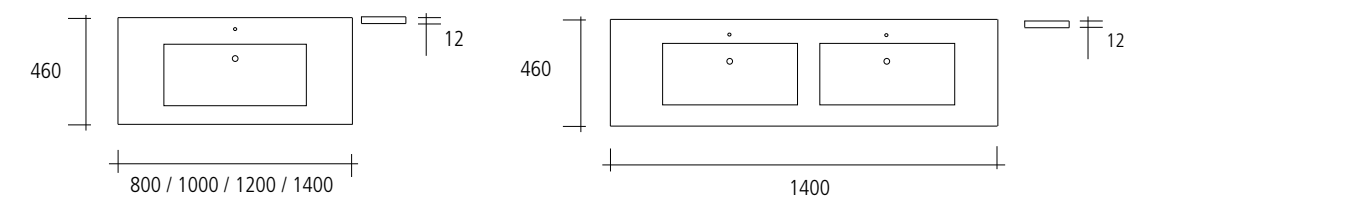

• MATERIAL: cerámica • MATIÈRE: céramique • MATERIAL: ceramic

## CAMBRILS

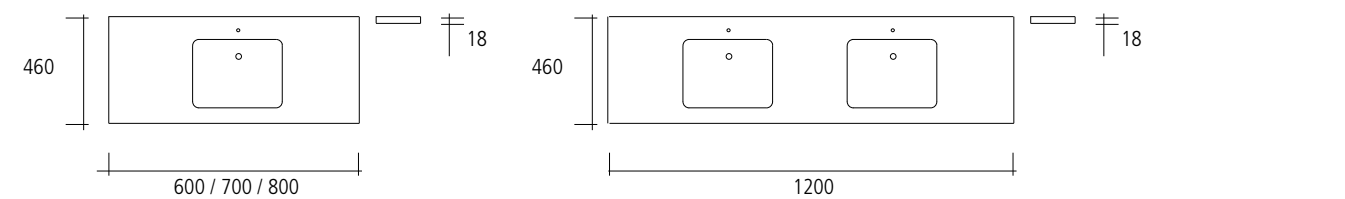

## CIRCLE

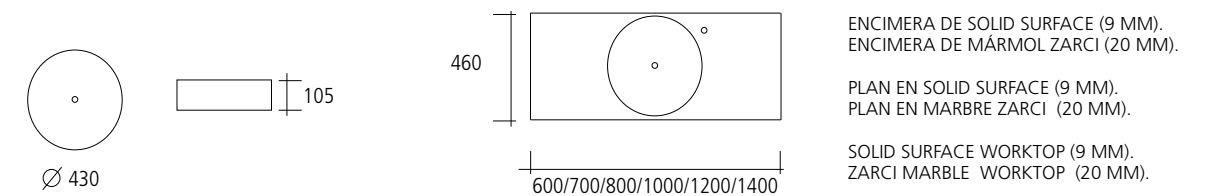

ENCIMERA DE SOLID SURFACE (9 MM).  
ENCIMERA DE MÁRMOL ZARCI (20 MM).

PLAN EN SOLID SURFACE (9 MM).  
PLAN EN MARBRE ZARCI (20 MM).

SOLID SURFACE WORKTOP (9 MM).  
ZARCI MARBLE WORKTOP (20 MM).

# BAXE



BAXE 80 [044] ■ DARITO 80 ■ ISI 80 ■ DEVA



BAXE 140 [117] ■ LAO 140 ■ ISI 140 ■ DEVA



BAXE 80 [044] ■ DARITO 80



BAXE 140 [117] ■ LAO 140



# BAXE

MEDIDAS | MESURES | MEASUREMENTS

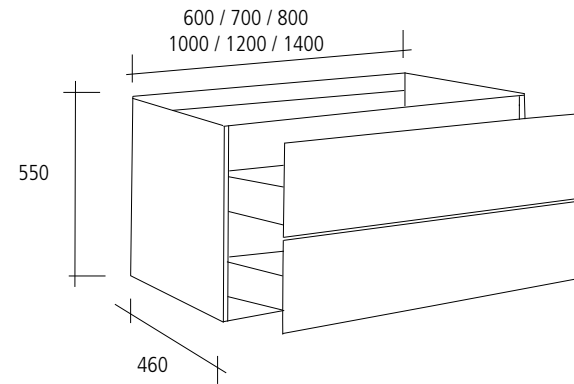

• **Tableros PEFC con bajo contenido en formaldehído, según NORMA EU E1 y EE UU CARB2.**

• **Panneaux (agglomérés ou mdf) PEFC à faible teneur en formaldéhyde, selon la NORME EUROPÉENNE CLASSE E1 et AMÉRICAINNE CARB2.**

• **PEFC low formaldehyde content boards, conforming to STANDARDS EU E1 and EEUU CARB2.**

ACABADOS | FINITIONS | FINISHES

Lacado satinado | Laques satinées | Silk lacquered



Melaminado | Mé laminé | Melamine

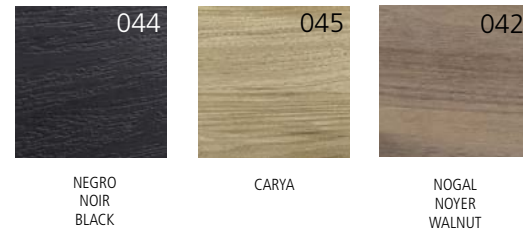

MATERIALES | MATÉRIELS | MATERIALS

ESTRUCTURA   STRUCTURE   STRUCTURE	FRENTE   FAÇADES   FRONTS			LATERALES   CÔTÉS   SIDES		
	AGLOMERADO 16 MM AGGLOMÉRÉ 16 MM 16 MM CHIPBOARD	AGLOMERADO 16 MM AGGLOMÉRÉ 16 MM 16 MM CHIPBOARD	MDF HIDRÓFUGO 16 MM MDF HYDROFUGE 16 MM MOISTURE RESISTANT 16 MM MDF	MADERA MACIZA 21 MM BOIS MASSIF 21 MM 21 MM SOLID TIMBER	AGLOMERADO 16 MM AGGLOMÉRÉ 16 MM 16 MM CHIPBOARD	MDF 10 MM
✓	✓			✓		
CAJONES EXTRACCIÓN TOTAL TIROIR OUVERTURE TOTALE FULL EXTENSION DRAWERS	CAJÓN CIERRE SILENCIOSO TIROIR FERMETURE EN DOUCEUR SOFT CLOSE DRAWER	PUERTA CIERRE SILENCIOSO CHARNIÈRES AVEC FREIN SOFT CLOSE DOOR	CAJONES "PUSH" TIROIRS "PUSH" PUSH DRAWERS	HUECO TUBERÍAS VIDE SANITAIRE SERVICE SPACE		
✓	✓			✓		

• CAJÓN METÁLICO DE CIERRE SILENCIOSO, APERTURA TOTAL Y CAPACIDAD DE CARGA DE 40 KG.  
TIROIR AVEC CÔTÉS MÉTALLIQUES, TIROIR FERMETURE EN DOUCEUR, À OUVERTURE TOTALE ET CAPACITÉ DE CHARGE 40 KG.  
METAL SIDED SOFT CLOSE DRAWER, FULL EXTENSION WITH 40 KG CAPACITY.

• COLGADOR DE ALTA RESISTENCIA, REGULABLE, CON CARGA MÁXIMA 65KG/ UNIDAD SEGÚN DIN 68840, CERTIFICADO LGA.  
FIXATIONS MURALES DE HAUTE RÉSIDANCE, RÉGLABLES, CHARGE MAXI 65KG/UNITÉ, SELON DIN 68840, CERTIFIÉ LGA.  
ADJUSTABLE WALL HANGER WITH HIGH CAPACITY OF 65 KG, CONFORMING TO STANDARDS DIN 68840, LGA CERTIFIED.

# BAXE

LAVABOS | PLAN VASQUES | WASHBASINS

• **MATERIAL: solid surface acrílico • MATIÈRE: solid surface acrylique • MATERIAL: acrylic solid surface**

LAO

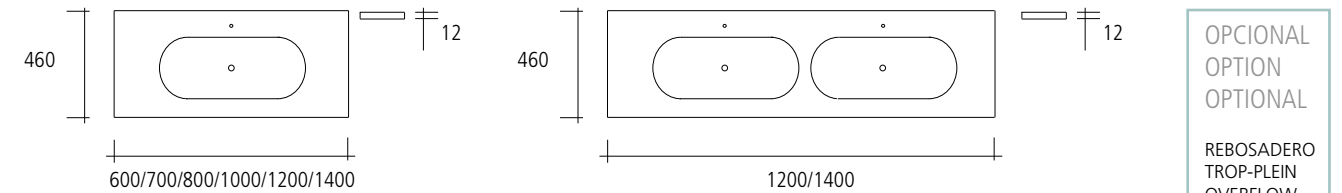

KOLO

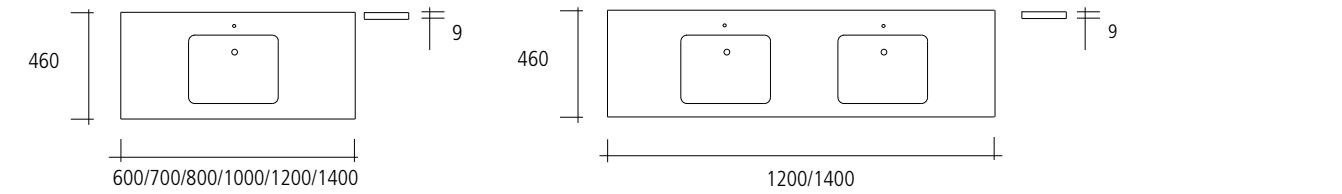

DARITO

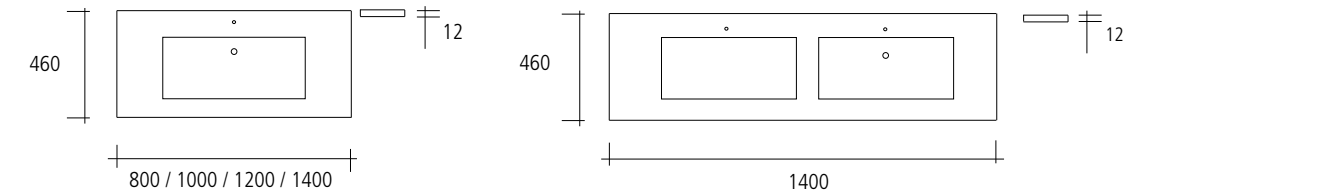

• **MATERIAL: cerámica • MATIÈRE: céramique • MATERIAL: ceramic**

CAMBRILS

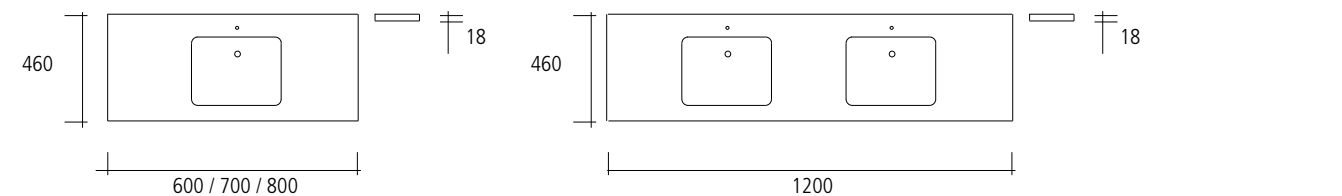

CIRCLE

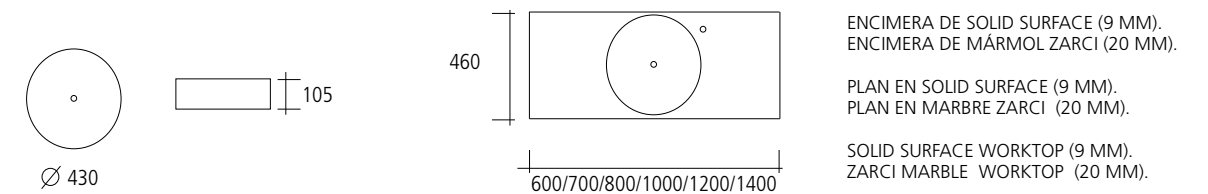



## MEDIDAS | MESURES | MEASUREMENTS

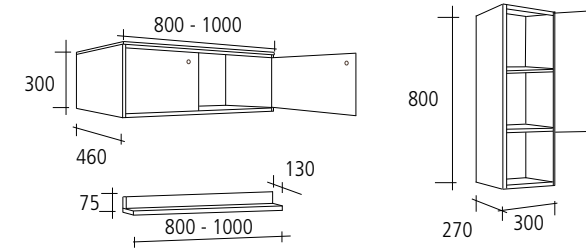

## ACABADOS | FINITIONS | FINISHES

Madera maciza | Bois massif | Solid wood

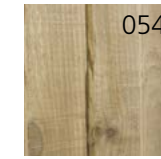

MADERA ENVEJECIDA  
BOIS VIEILLI  
DISTRESSED WOOD

- MUEBLE EN MADERA MACIZA
- MEUBLE EN BOIS MASSIF.
- SOLID WOOD VANITY.

## MATERIALES | MATÉRIELS | MATERIALS

ESTRUCTURA   STRUCTURE   STRUCTURE	FRENTES   FAÇADES   FRONTS			LATERALES   CÔTÉS   SIDES		
PINO MACIZO 21 MM PIN MASSIF 21 MM 21 MM SOLID PINE	AGLOMERADO 16 MM AGGLOMÉRÉ 16 MM 16 MM CHIPBOARD	MDF HIDRÓFUGO 16 MM MDF HYDROFUGE 16 MM MOISTURE RESISTANT 16 MM MDF	PINO MACIZO 21 MM PIN MASSIF 21 MM 21 MM SOLID PINE	AGLOMERADO 16 MM AGGLOMÉRÉ 16 MM 16 MM CHIPBOARD	MDF 10 MM	PINO MACIZO 21 MM PIN MASSIF 21 MM 21 MM SOLID PINE
✓			✓			✓
CAJONES EXTRACCIÓN TOTAL TIROIR OUVERTURE TOTALE FULL EXTENSION DRAWERS	CAJÓN CIERRE SILENCIOSO TIROIR FERMETURE EN DOUCEUR SOFT CLOSE DRAWER	PUERTA CIERRE SILENCIOSO CHARNIÈRES AVEC FREIN SOFT CLOSE DOOR		CAJONES "PUSH" TIROIRS "PUSH" PUSH DRAWERS		HUECO TUBERÍAS VIDE SANITAIRE SERVICE SPACE
		✓				✓

- COLGADOR DE ALTA RESISTENCIA, REGULABLE, CON CARGA MÁXIMA 65KG/ UNIDAD SEGÚN DIN 68840, CERTIFICADO LGA. FIXATIONS MURALES DE HAUTE RÉSISTANCE, RÉGLABLES, CHARGE MAXI 65KG/UNITÉ, SELON DIN 68840, CERTIFIÉ LGA. ADJUSTABLE WALL HANGER WITH HIGH CAPACITY OF 65 KG, CONFORMING TO STANDARDS DIN 68840, LGA CERTIFIED.

## LAVABOS | PLAN VASQUES | WASHBASINS

• MATERIAL: solid surface acrílico • MATIÈRE: solid surface acrylique • MATERIAL: acrylic solid surface

LAO

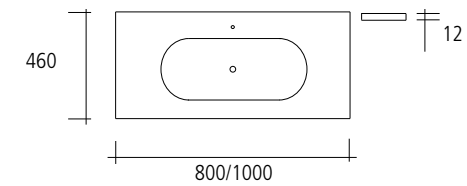

OPCIONAL  
OPTION  
OPTIONAL

REBOSADERO  
TROP-PLEIN  
OVERFLOW

KOLO

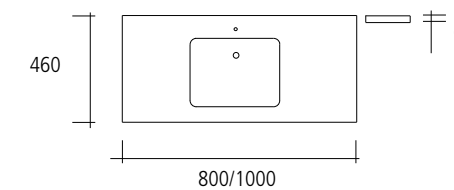

• MATERIAL: cerámica • MATIÈRE: céramique • MATERIAL: ceramic  
CIRCLE

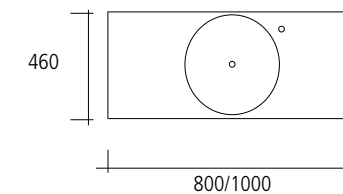
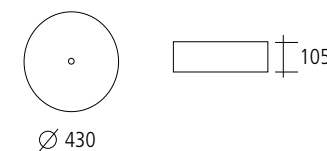

ENCIMERA DE SOLID SURFACE (9 MM).  
ENCIMERA DE MÁRMOL ZARCI (20 MM).

PLAN EN SOLID SURFACE (9 MM).  
PLAN EN MARBRE ZARCI (20 MM).

SOLID SURFACE WORKTOP (9 MM).  
ZARCI MARBLE WORKTOP (20 MM).

# CLIFT



CLIFT 60 [011] ■ ISI 60 ■ DEVA



CLIFT 50 [045] ■ ISI 50 ■ DEVA





# CLIFT

MEDIDAS | MESURES | MEASUREMENTS

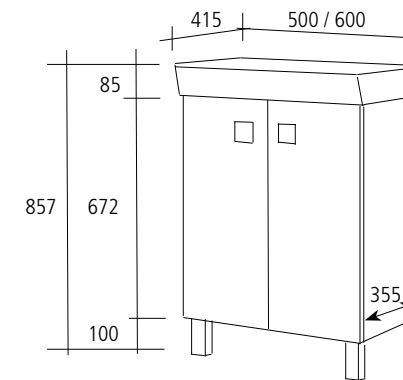

- Tableros PEFC con bajo contenido en formaldehído, según NORMA EU E1 y EE UU CARB2.
- Panneaux (agglomérés ou mdf) PEFC à faible teneur en formaldéhyde, selon la NORME EUROPÉENNE CLASSE E1 et AMÉRICAINNE CARB2.
- PEFC low formaldehyde content boards, conforming to STANDARDS EU E1 and EEUU CARB2.

ACABADOS | FINITIONS | FINISHES

Lacado satinado | Laques satinées | Silk lacquered



Melaminado | Mèlaminé | Melamine

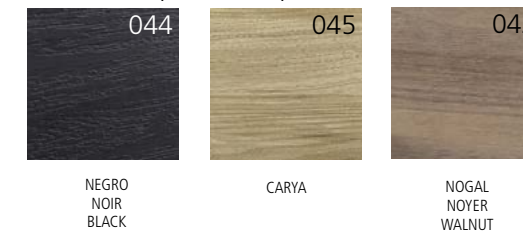

MATERIALES | MATÉRIELS | MATERIALS

ESTRUCTURA   STRUCTURE   STRUCTURE	FRENTES   FAÇADES   FRONTS			LATERALES   CÔTÉS   SIDES		
	AGLOMERADO 16 MM AGGLOMÉRÉ 16 MM 16 MM CHIPBOARD	AGLOMERADO 16 MM AGGLOMÉRÉ 16 MM 16 MM CHIPBOARD	MDF HIDRÓFUGO 16 MM MDF HYDRÓFUGE 16 MM MOISTURE RESISTANT 16 MM MDF	MADERA MACIZA 21 MM BOIS MASSIF 21 MM 21 MM SOLID TIMBER	AGLOMERADO 16 MM AGGLOMÉRÉ 16 MM 16 MM CHIPBOARD	MDF 10 MM
✓	✓			✓		
<b>CAJONES EXTRACCIÓN TOTAL TIROIR OUVERTURE TOTALE FULL EXTENSION DRAWERS</b>	<b>CAJÓN CIERRE SILENCIOSO TIROIR FERMETURE EN DOUCEUR SOFT CLOSE DRAWER</b>	<b>PUERTA CIERRE SILENCIOSO CHARNIÈRES AVEC FREIN SOFT CLOSE DOOR</b>		<b>CAJONES "PUSH" TIROIRS "PUSH" PUSH DRAWERS</b>		<b>HUECO TUBERÍAS VIDE SANITAIRE SERVICE SPACE</b>
		✓				✓

- COLGADOR DE ALTA RESISTENCIA, REGULABLE, CON CARGA MÁXIMA 65KG/ UNIDAD SEGÚN DIN 68840, CERTIFICADO LGA.  
FIXATIONS MURALES DE HAUTE RÉSIDANCE, RÉGLABLES, CHARGE MAXI 65KG/UNITÉ, SELON DIN 68840, CERTIFIÉ LGA.  
ADJUSTABLE WALL HANGER WITH HIGH CAPACITY OF 65 KG, CONFORMING TO STANDARDS DIN 68840, LGA CERTIFIED.

# TIMBER



TIMBER 120 [011] ■ CAMBRILS 120 ■ ISI 120 ■ DEVA



TIMBER 60 [011] ■ CAMBRILS 60 ■ RADIO 60 ■ DEVA

# TIMBER



TIMBER 80 [045] • CAMBRILS 80 • ISI 80 • DEVA

# TIMBER

MEDIDAS | MESURES | MEASUREMENTS

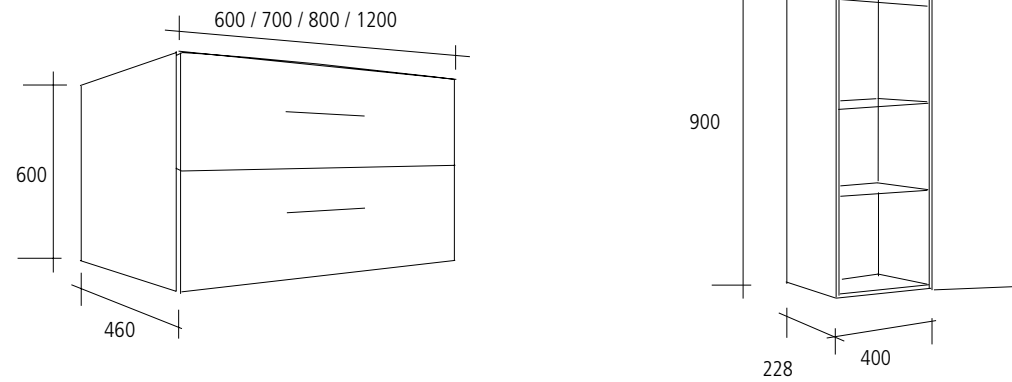

- Tableros PEFC con bajo contenido en formaldehído, según NORMA EU E1 y EE UU CARB2.
- Panneaux (agglomérés ou mdf) PEFC à faible teneur en formaldéhyde, selon la NORME EUROPÉENNE CLASSE E1 et AMÉRICAINNE CARB2.
- PEFC low formaldehyde content boards, conforming to STANDARDS EU E1 and EEUU CARB2.

## ACABADOS | FINITIONS | FINISHES

Lacado satinado | Laques satinées | Silk lacquered



Melaminado | Mé laminé | Melamine

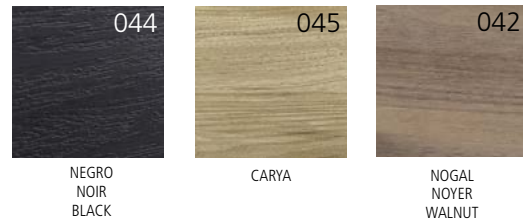

## MATERIALES | MATÉRIELS | MATERIALS

ESTRUCTURA   STRUCTURE   STRUCTURE	FRENTE   FAÇADES   FRONTS			LATERALES   CÔTÉS   SIDES		
AGLOMERADO 16 MM AGGLOMÉRÉ 16 MM 16 MM CHIPBOARD	AGLOMERADO 16 MM AGGLOMÉRÉ 16 MM 16 MM CHIPBOARD	MDF HIDRÓFUGO 16 MM MDF HYDROFUGE 16 MM MOISTURE RESISTANT 16 MM MDF	MADERA MACIZA 21 MM BOIS MASSIF 21 MM 21 MM SOLID TIMBER	AGLOMERADO 16 MM AGGLOMÉRÉ 16 MM 16 MM CHIPBOARD	MDF 10 MM	MADERA MACIZA 21 MM BOIS MASSIF 21 MM 21 MM SOLID TIMBER
✓	✓			✓		
CAJONES EXTRACCIÓN TOTAL TIROIR OUVERTURE TOTALE FULL EXTENSION DRAWERS	CAJÓN CIERRE SILENCIOSO TIROIR FERMETURE EN DOUCEUR SOFT CLOSE DRAWER	PUERTA CIERRE SILENCIOSO CHARNIÈRES AVEC FREIN SOFT CLOSE DOOR	CAJONES "PUSH" TIROIRS "PUSH" PUSH DRAWERS	HUECO TUBERÍAS VIDE SANITAIRE SERVICE SPACE		
✓	✓			✓		

- CAJÓN METÁLICO DE CIERRE SILENCIOSO, APERTURA TOTAL Y CAPACIDAD DE CARGA DE 40 KG. TIROIR AVEC CÔTÉS MÉTALLIQUES, TIROIR FERMETURE EN DOUCEUR, À OUVERTURE TOTALE ET CAPACITÉ DE CHARGE 40 KG. METAL SIDED SOFT CLOSE DRAWER, FULL EXTENSION WITH 40 KG CAPACITY.

- COLGADOR DE ALTA RESISTENCIA, REGULABLE, CON CARGA MÁXIMA 65KG/ UNIDAD SEGÚN DIN 68840, CERTIFICADO LGA. FIXATIONS MURALES DE HAUTE RÉ SISTANCE, RÉGLABLES, CHARGE MAXI 65KG/UNITÉ, SELON DIN 68840, CERTIFIÉ LGA. ADJUSTABLE WALL HANGER WITH HIGH CAPACITY OF 65 KG, CONFORMING TO STANDARDS DIN 68840, LGA CERTIFIED.

# TIMBER

LAVABOS | PLAN VASQUES | WASHBASINS

- MATERIAL: solid surface acrílico • MATIÈRE: solid surface acrylique • MATERIAL: acrylic solid surface

LAO

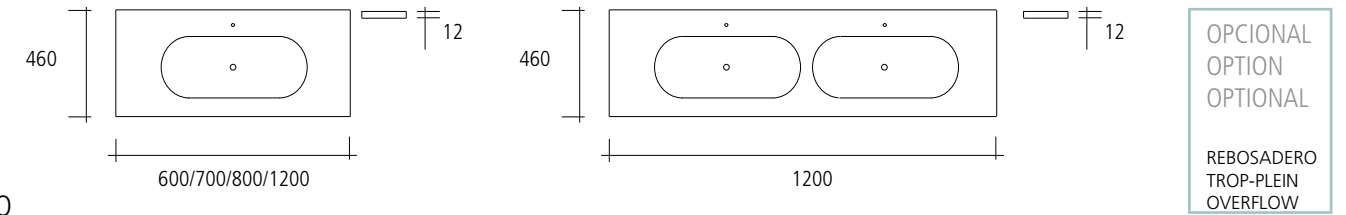

KOLO

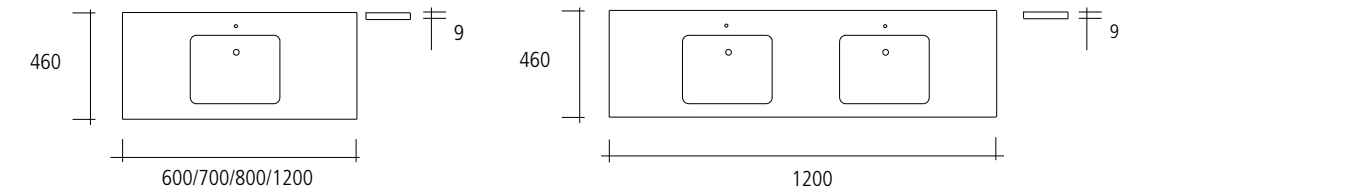

DARITO



- MATERIAL: cerámica • MATIÈRE: céramique • MATERIAL: ceramic

CAMBRILS

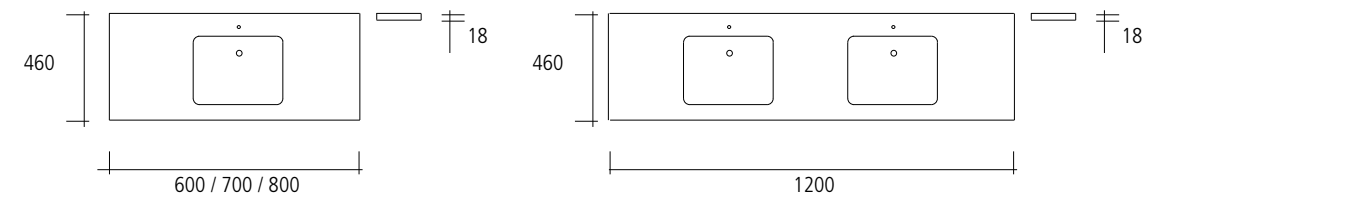

CIRCLE

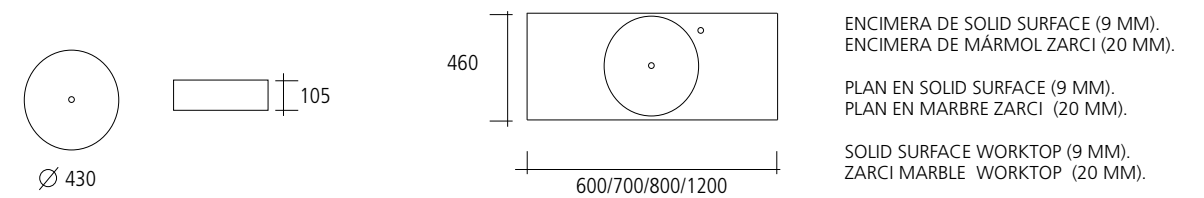

# LENOX



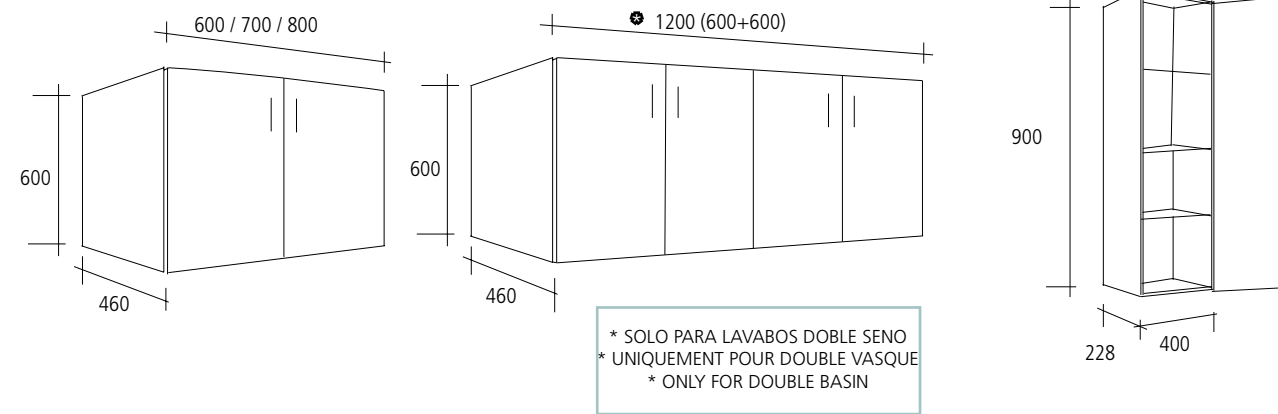

- Tableros PEFC con bajo contenido en formaldehído, según NORMA EU E1 y EE UU CARB2.
- Panneaux (aglomerados ou mdf) PEFC à faible teneur en formaldéhyde, selon la NORME EUROPÉENNE CLASSE E1 et AMÉRICAINNE CARB2.
- PEFC low formaldehyde content boards, conforming to STANDARDS EU E1 and EEUU CARB2.

## ACABADOS | FINITIONS | FINISHES

Lacado satinado | Laques satinées | Silk lacquered



Melaminado | Mé laminé | Melamine

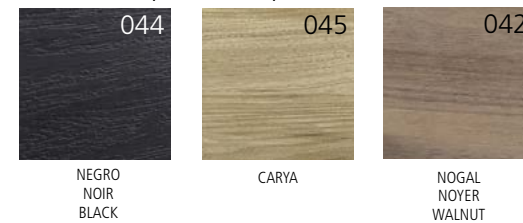

## MATERIALES | MATÉRIELS | MATERIALS

ESTRUCTURA   STRUCTURE   STRUCTURE	FRENTES   FAÇADES   FRONTS			LATERALES   CÔTÉS   SIDES		
AGLOMERADO 16 MM AGGLOMÉRÉ 16 MM 16 MM CHIPBOARD	AGLOMERADO 16 MM AGGLOMÉRÉ 16 MM 16 MM CHIPBOARD	MDF HIDRÓFUGO 16 MM MDF HYDROFUGE 16 MM MOISTURE RESISTANT 16 MM MDF	MADERA MACIZA 21 MM BOIS MASSIF 21 MM 21 MM SOLID TIMBER	AGLOMERADO 16 MM AGGLOMÉRÉ 16 MM 16 MM CHIPBOARD	MDF 10 MM	MADERA MACIZA 21 MM BOIS MASSIF 21 MM 21 MM SOLID TIMBER
✓	✓			✓		
CAJONES EXTRACCIÓN TOTAL TIROIR OUVERTURE TOTALE FULL EXTENSION DRAWERS	CAJÓN CIERRE SILENCIOSO TIROIR FERMETURE EN DOUCEUR SOFT CLOSE DRAWER	PUERTA CIERRE SILENCIOSO CHARNIÈRES AVEC FREIN SOFT CLOSE DOOR		CAJONES "PUSH" TIROIRS "PUSH" PUSH DRAWERS		HUECO TUBERÍAS VIDE SANITAIRE SERVICE SPACE
		✓				✓

- COLGADOR DE ALTA RESISTENCIA, REGULABLE, CON CARGA MÁXIMA 65KG/ UNIDAD SEGÚN DIN 68840, CERTIFICADO LGA.
- FIXATIONS MURALES DE HAUTE RÉSISTANCE, RÉGLABLES, CHARGE MAXI 65KG/UNITÉ, SELON DIN 68840, CERTIFIÉ LGA.
- ADJUSTABLE WALL HANGER WITH HIGH CAPACITY OF 65 KG, CONFORMING TO STANDARDS DIN 68840, LGA CERTIFIED.

## LAVABOS | PLAN VASQUES | WASHBASINS

- MATERIAL: solid surface acrílico • MATIÈRE: solid surface acrylique • MATERIAL: acrylic solid surface

### LAO

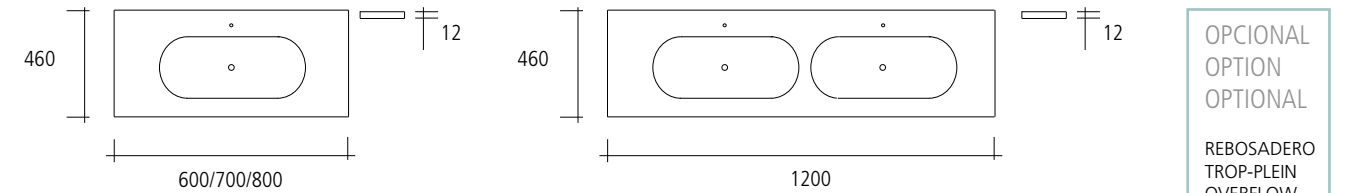

### KOLO

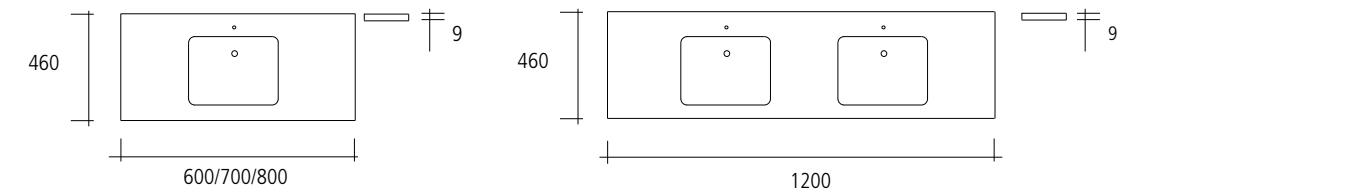

### DARITO



- MATERIAL: cerámica • MATIÈRE: céramique • MATERIAL: ceramic

### CAMBRILS

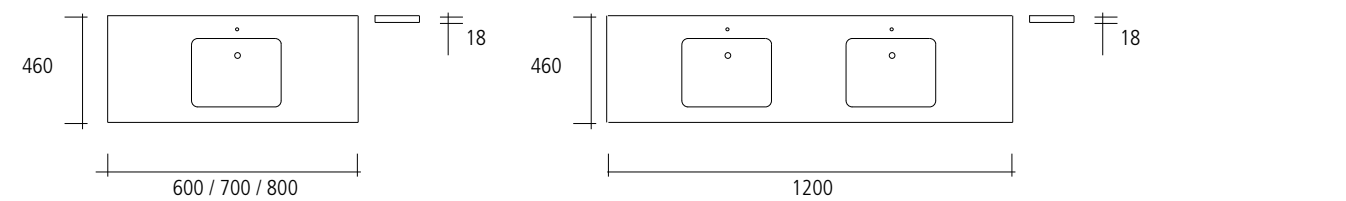

### CIRCLE

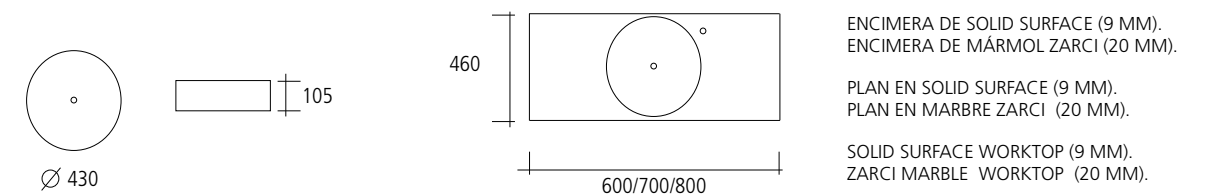

# ARTIK



## MEDIDAS | MESURES | MEASUREMENTS

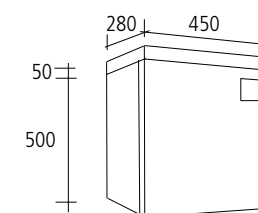

# ARTIK

- Tableros PEFC con bajo contenido en formaldehído, según NORMA EU E1 y EE UU CARB2.
- Panneaux (agglomérés ou mdf) PEFC à faible teneur en formaldéhyde, selon la NORME EUROPÉENNE CLASSE E1 et AMÉRICAINNE CARB2.
- PEFC low formaldehyde content boards, conforming to STANDARDS EU E1 and EEUU CARB2.

## ACABADOS | FINITIONS | FINISHES

Lacado satinado | Laques satinées | Silk lacquered



Melaminado | Mé laminé | Melamine



## MATERIALES | MATÉRIELS | MATERIALS

ESTRUCTURA   STRUCTURE   STRUCTURE	FRENTES   FAÇADES   FRONTS			LATERALES   CÔTÉS   SIDES		
	AGLOMERADO 16 MM AGGLOMÉRÉ 16 MM 16 MM CHIPBOARD	AGLOMERADO 16 MM AGGLOMÉRÉ 16 MM 16 MM CHIPBOARD	MDF HIDRÓFUGO 16 MM MDF HYDROFUGE 16 MM MOISTURE RESISTANT 16 MM MDF	PINO MACIZO 21 MM PIN MASSIF 21 MM 21 MM SOLID PINE	AGLOMERADO 16 MM AGGLOMÉRÉ 16 MM 16 MM CHIPBOARD	MDF 10 MM
✓	✓	✓		✓		
CAJONES EXTRACCIÓN TOTAL TIROIR OUVERTURE TOTALE FULL EXTENSION DRAWERS	CAJÓN CIERRE SILENCIOSO TIROIR FERMETURE EN DOUCEUR SOFT CLOSE DRAWER	PUERTA CIERRE SILENCIOSO CHARNIÈRES AVEC FREIN SOFT CLOSE DOOR		CAJONES "PUSH" TIROIRS "PUSH" PUSH DRAWERS		HUECO TUBERÍAS VIDE SANITAIRE SERVICE SPACE
		✓				

- COLGADOR DE ALTA RESISTENCIA, REGULABLE, CON CARGA MÁXIMA 65KG/ UNIDAD SEGÚN DIN 68840, CERTIFICADO LGA. FIXATIONS MURALES DE HAUTE RÉSIDANCE, RÉGLABLES, CHARGE MAXI 65KG/UNITÉ, SELON DIN 68840, CERTIFIÉ LGA. ADJUSTABLE WALL HANGER WITH HIGH CAPACITY OF 65 KG, CONFORMING TO STANDARDS DIN 68840, LGA CERTIFIED.

# COMPLEMENTOS / COMPLEMENTS

## ESPEJOS | MIROIRS | MIRRORS

MINI

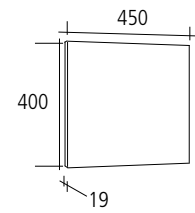

ISI

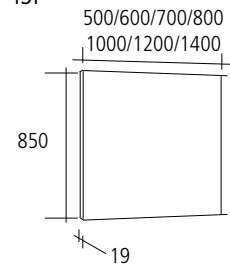

MILO

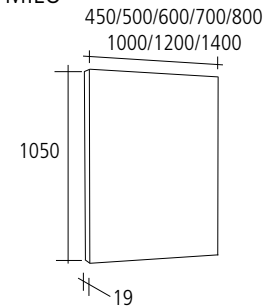

RADIO

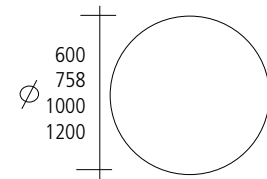

## ILUMINACIÓN | ÉCLAIRAGE | LIGHTNING [LED IP44]

DEVA



ODET



## OPCIONAL | OPTION | OPTIONAL



[ES]

Los datos y características indicados en este catálogo no son vinculantes.  
 NAXANI DESIGN SL se reserva los derechos de cualquier modificación técnica y/o estética sin previo aviso.  
 Para especificaciones técnicas o medidas exactas les rogamos contacten con nuestro departamento comercial.  
 Los colores de los materiales y acabados son sólo indicativos.  
 Los productos del catálogo están sujetos a la Ley de Protección Jurídica del Diseño Industrial, siendo Naxani el propietario del Diseño Industrial de los mismos, registrados en la Oficina Europea de Patentes y Marcas.

[FR]

Les données et caractéristiques indiquées dans ce catalogue ne sont pas contractuelles.  
 NAXANI DESIGN SL se réserve le droit de tout changement technique ou esthétique sans préavis.  
 Pour obtenir une dimension précise ou une spécificité technique, vous devez contacter notre département commercial.  
 Les couleurs et finitions sont donnés à titre indicatif.  
 Les produits du catalogue sont la propriété de Naxani et enregistrés à l'Office de l'Union Européenne pour la propriété intellectuelle .

[EN]

The information and characteristics specified in this catalogue are not binding.  
 NAXANI DESIGN SL reserves the right to make any modifications without the obligation to give notice thereof.  
 Please contact our commercial department for technical specifications or exact measurements.  
 Colours of materials and finishes are only indicative.  
 All copyrights and intellectual property rights, including trademarks, and Industrial Design, remain the property of Naxani and are explicitly reserved on the European Union Intellectual Property Office.



**NX**

Naxani Design SL  
Valencia, **Spain**

T. +34 962 456 363  
F. +34 962 404 589  
info@naxani.com

**naxani.com**