

NX

2023 COLLECTION

*Designing bathrooms...*



## INDEX

Aalto	54
Aran	222
Bacall	18
Banaavat	08
Batz	132
Bert	108
Boxy	230
Chic	72
Doki mini	243
Dumbo	92
Ernie	96
Grid	218
Hayem	194
Igi	124
Kondo	116
Linjer	140
Malmö	234
Marmor	200
Memphis	204
Nebbe	227
Osovan	62
Prenn	170
Puma	236
Roten	158
Shosuba	148
Simenta	04
Slat	28
Suró	48
Tulip	212
Unda	78
Valnöt	186
Complementos / Complements	240
Medidas / Mesures / Measurements	244
Lavabos / Plan Vasques / Washbasins	256
Iluminación / Éclairage / Lighting	262
Acabados / Finitions / Finishes	260

*Simenta*







Simenta 200 Betón wevet - Forma Large 200 wasbasin - Ilargi 120 mirror



*Banaavat*

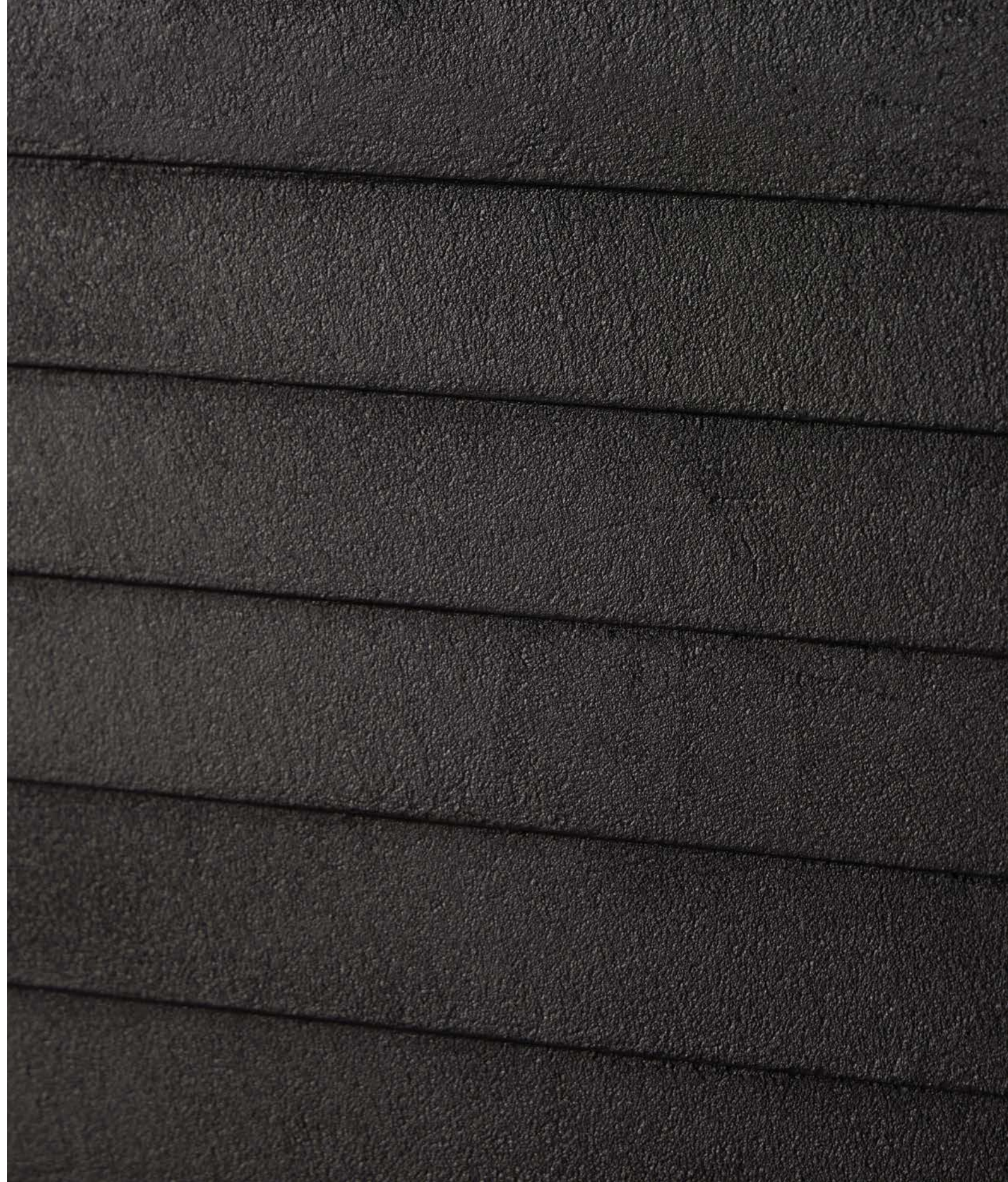





**Banaavat** 2C 160 Betón grafito - **Daro** 160 washbasin - **Haruki** mirror - **Banaavat** 2P Grafito Betón wall cabinet



**Banaavat** 2C 160 Betón grafito







*Banaavat* 1C 180 Betón natural



*Bacall*







**Bacall 1C** 122 Walnut - **Alma** 122 washbasin - **Aalto** 120 Walnut mirror



**Bacall 1C** 182 Iroko - **Forma Large** 182 washbasin - **Slope** 180 120 Iroko mirror







**Bacall 2C 102 Iroko - Ares 102 washbasin - Callisto 60 mirror**





**Bacall 2 C 162** Maple - Solid top 162 - Oval basin - **Dondo XXL** mirror



*Slat*









**Slat 1C** 140 Walnut - **Daro** 140 washbasin - **Ilargi** 120 Solid mirror - **Slat 1P** Walnut wall cabinet





*Slat 1C* 140 Oak - *Forma large* 140 washbasin - *Aalto* 140 Oak mirror - *Kondo 3P* Oak wall cabinet





**Slat 1C Twin** 200 Maple - Solid top 200 - 1Q84 basin - **Callisto** mirrors



**Slat 1C** 100 Maple - **2R** washbasin - **Nou** solid mirror



*Slat 1C 120 Ash - Ares 120 washbasin - Haruki 120 mirror - Kondo 3P White wall cabinet*







Slat 2C 180 Walnut - Forma Large 180 washbasin - Haruki 120 mirror







**Slat 2C** 140 Iroko - Solid top 140 - **1Q84** basin - **Ilargi** 120 Solid mirror - **Slat 2P** Iroko wall cabinet



*Suró*

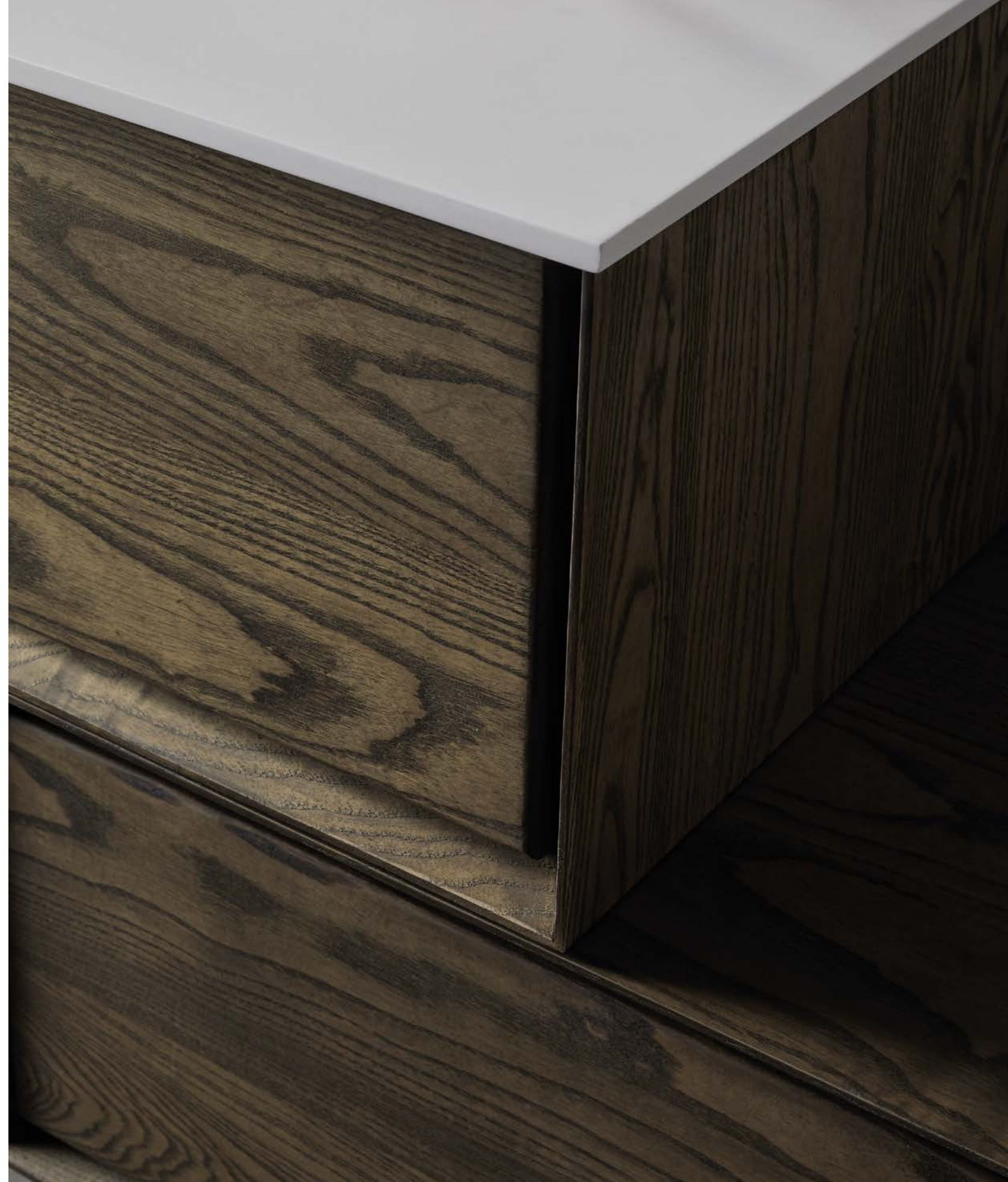





*Suró 31* 140 Smoked Ash - *Daro* 140 washbasin - *Ilargi* 120 Solid mirror - *Suró* 2P wall cabinet





**Suró 64** 160 Smoked Ash - Solid top 160 - **1Q84** basin - **Suró** 150 Smoked Ash mirror - **Suró** 2P wall cabinet

*Aalto*







**Aalto 130 Oak - Daro 130 washbasin - Aalto 130 Oak mirror**





*Aalto* 150 Walnut - *Daro* 150 washbasin - *Nou* Solid surface mirrors - *Kondo 2P* Walnut Shelving unit



**Aalto 150** Walnut - **Daro 150** washbasin - **Nou** Solid surface mirrors - **Kondo 2P** Walnut Shelving unit

*Osnovan*







**Osnovan 1C 160 White - Solid top 160 - Oval basin - Callisto 70 mirrors**



**Osnovan 1C 140 Wevet - Daro 140 washbasin - Callisto 140 mirror**





**Osnovan 2C** 140 Cemento Tex - **Daro** 140 washbasin - **Haruki** mirror - **Osnovan 2P** Cemento Tex shelving unit



Osnovan 2C 140 Cemento Tex





Osovan 2C 170 Grafito - Prim basin - Solid top 180 - Ilargi 120 mirror

*Chic*





**Chic** 200 Black - Solid top 200 - *Prim* basin - *Callisto* 160 mirror







**Chic 150** Wevet - **Aran 150** washbasin - **Callisto 150** mirror

*Unda*







**Unda** 180 Maple - **Daro** 180 washbasin - **Slope** 180 Maple mirror - **Kondo 1P** Maple







**Unda** 140 Walnut - Solid top 140 - **Rodó** basin - **Capiton** 140 mirror





Unda 140 Walnut - *Forma Large* 140 washbasin - *Aalto* 140 Walnut mirror





**Unda** 140 Ash - Solid top 140 - 1Q84 basin - *llargi* 120 Solid mirror



*Unda* 140 Ash - *Daro* 140 washbasin - *Aalto* 140 Ash mirror



*Dumbo*







*Dumbo* 160 Stained timber - Solid top 160 - *Oval* basin - *Nou* Solid mirror



*Ernie*

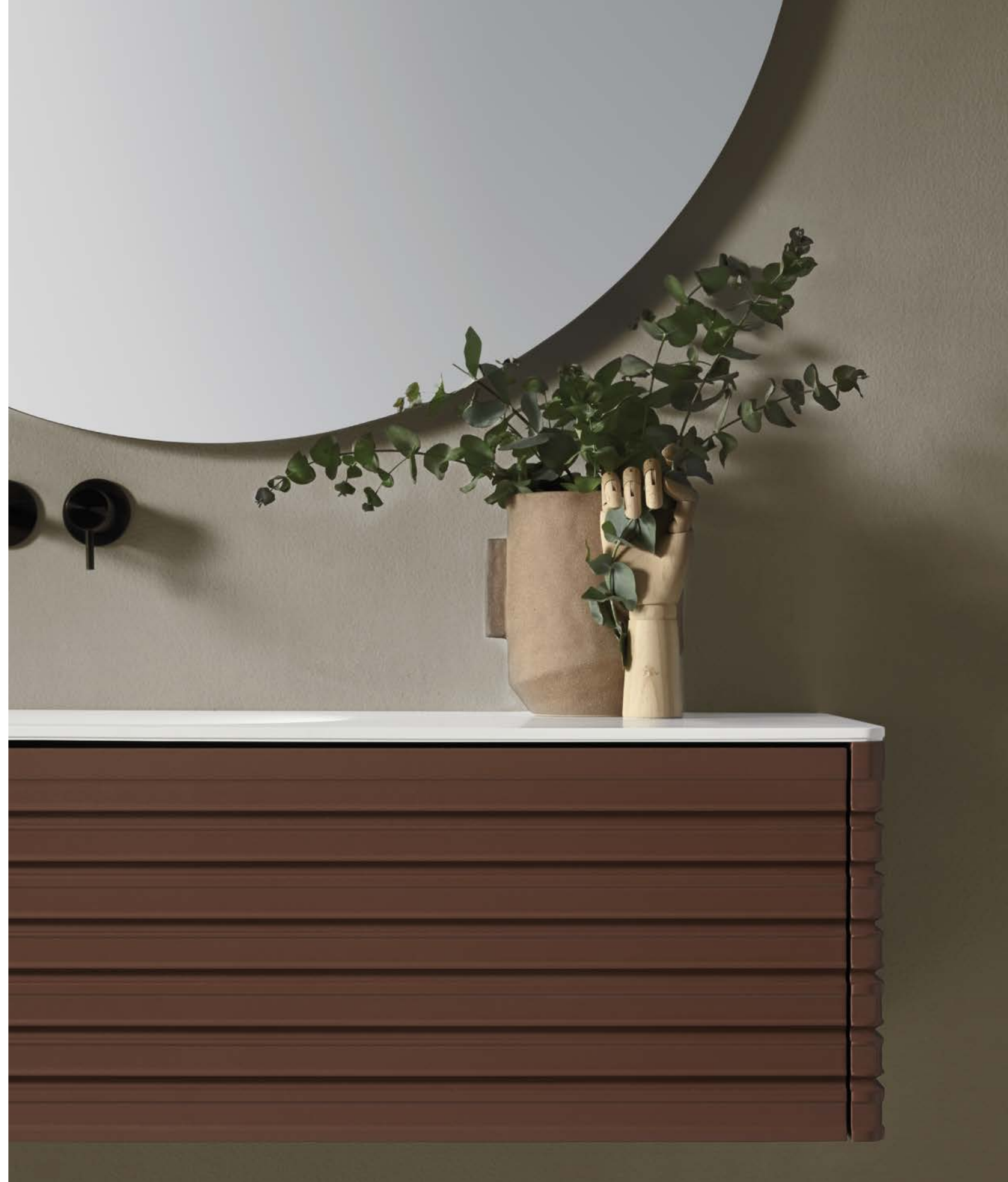









*Ernie* 100 Cemento - *2R* 100 washbasin - *Dondo* mirror



**Ernie** 200 Wevet - Solid top 200 - **Rodó** basins - **llargi** 120 solid mirror







Ernie 200 Wevet - Solid top 200 - Rodó basin - Ilargi 120 solid mirror



*Bert*





**Bert 120 Grafito - Forma Large 120 washbasin - Dondo XXL mirror**





**Bert 140 Ocean - Patra 140 washbasin - Eris 140 Solid mirror**





**Bert** 100 Blush - **Daro** 100 washbasin - **Eris** 100 Solid mirror





## *Kondo*

117





**Kondo 1P** Maple



**Kondo 3P Oak**

**Kondo 3P White**



**Kondo 2P** Walnut Shelving units



**Kondo 1P** Maple Shelving units



*Igi*





**lgi** 2C 110 Oak - **Daro** 110 washbasin - **Aalto** 100 Oak mirror





**lgi** 2C 180 Oak - Solid top 180 - **1Q84** basin - **llargi** 120 Solid mirror





**Igi** 1C 140 Oak - Marble Emperador top 140 - *Oval* basin - *Prenn* 140 Oak mirror



**Igi** 1C 140 Oak - 2R 140 washbasin - *Prenn* 140 Oak mirror



*Batz*







*Batz 1C 140 Oak - Patra 140 washbasin - Prenn 140 Oak mirror*





**Batz** 1C 140 Oak - Solid top 140 - **Prim** basin - **Prenn** 140 Oak mirror



**Batz** 2C 110 Oak - **Daro** 110 washbasin - **Eris** 110 Solid mirror



*Linjer*







*Linjer 1C 130 Ash - Latu 130 washbasin - Dondo XXL mirror*



**Linjer 2C 120** Ash - Solid top 120 - **Oval** basin - **Ilargi 120** Solid mirror



**Linjer 2C 140** Ash - **2R 140** washbasin - **Ilargi 120** Solid mirror



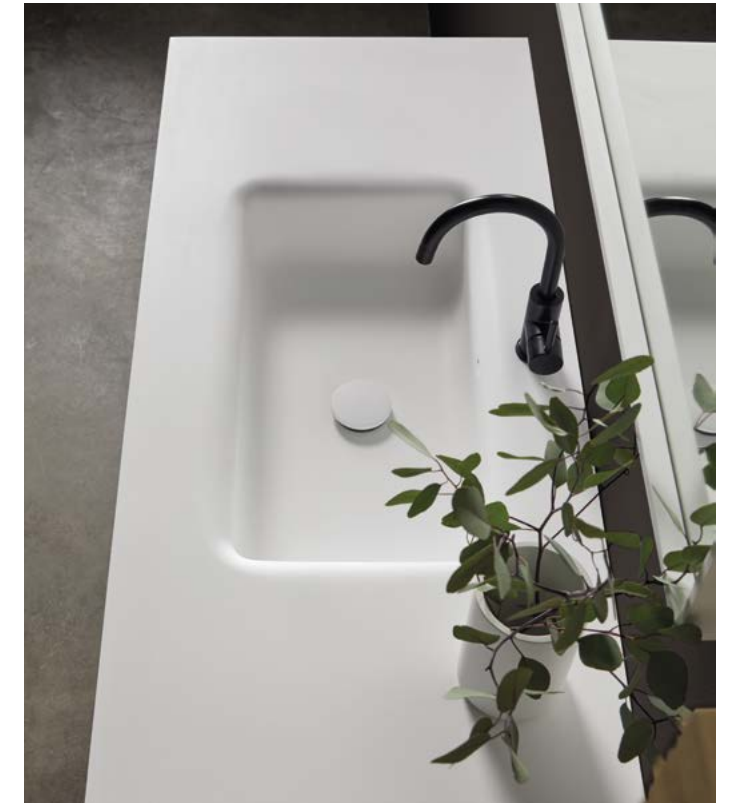

Linjer 2C 140 Ash - *Daro* 140 washbasin - *Eris* 110 Solid mirror - *Linjer* module



*Shosuba*



*Shosuba* 140 burned top - *Rodó* basin - *Shosuba* 110 White - *Eris* 110 mirror



**Shosuba** 140 Ash top - **Oval** basin - **Shosuba** 110 White - **Dondo XXL** mirror



**Shosuba 140** Ash top - **1Q84** basin - **Shosuba 80** White - **Magnetic 140** mirror







**Shosuba 140** burned top - **Prim** basin - **Shosuba 80** Terracota - **Capiton 140** mirror



*Shosuba 140 burned top - Prim basin - Shosuba 110 Cemento - Dondo XXL mirror*



*Roten*







**Roten 150 Ash - Forma Large 150** washbasin - **Aalto 150 Ash** mirror



**Roten** 150 Ash - **Forma Large 150** washbasin - **Aalto** 150 Ash mirror





Roten 180 White - *Forma Large* 180 washbasin - *Ilargi* 120 Solid mirror - *Roten* White wall cabinet - *Ren* 80 Solid shelf





**Roten** 210 Black - Solid top 210 - **1Q84** basin - **Eris** 150 Solid mirror - **Roten** Black wall cabinet - **Ren** small Solid shelf



1Q84 basin

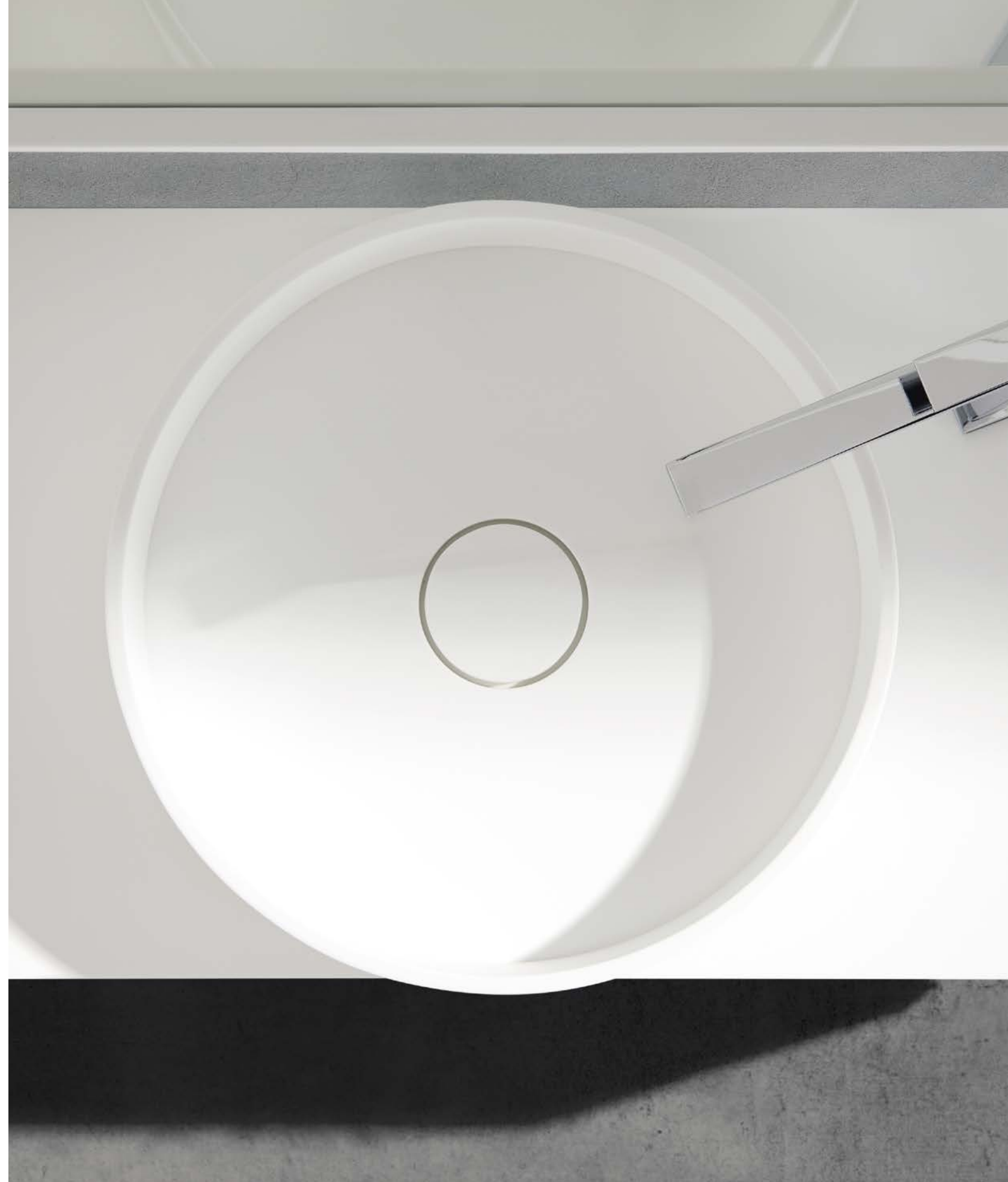



*Prenn*







*Prenn 31-150 Burned - Oval basin - Prenn 31-150 burned complement - Capiton 90 mirror - Capiton 140 mirror*



**Prenn** 31-140 Burned - **Square** 140 washbasin - **Prenn** 31-140 Burned complement - **Haruki** 120 mirror



*Prenn 31-130 Maple - Square 130 washbasin - Ilargi 120 mirror - Kondo 1P Maple Shelving Unit*





**Prenn** 31-140 Oak - Emperador 140 Marble top - **Prim** basin - **Prenn** 31-140 Oak complement - **Prenn** 140 Oak mirror



**Prenn** 31-140 Walnut - **Daro** 140 washbasin - **Prenn** 31-140 Walnut complement - **Prenn** 140 Walnut mirror



**Prenn** 31-140 Walnut - **Marquina** 140 Marble top - **1Q84** basin - **Prenn** 31-140 Walnut complement - **Prenn** 140 Walnut mirror





**Prenn 64-160 Oak - Prenn 160 washbasin - Prenn 160 and 50 Oak mirrors - Prenn Oak wall cabinet**



**Prenn 64-140 Iroko - Prenn 140 washbasin - Prenn 140 Iroko mirror - Prenn 50 Iroko mirror**







*Prenn 31-140 Iroko - Prenn 140 washbasin - Prenn 31-140 Iroko complement - Elara 140 mirror*

*Valnöt*





**Valnöt** 160 Walnut - Marquina 160 Marble top - **Oval** basin - **Aalto** 150 Walnut mirror





Valnöt 160 Walnut - Patra 160 washbasin - Ilargi 120 Solid mirror





*Valnöt* 200 Walnut - *Aran* 200 washbasin - *Dondo XXL* mirror - *Ren* 80 Solid shelf

*Hayem*







**Hayem** 150 White - Solid top 150 - **Ofali** 120 basin - **Hayem** towell rail Walnut and one door White complement - **Aalto** 140 mirror - **Cubo** 35 Walnut shelf



*Hayem 150* White - *Hayem* Walnut towell rail - *Latu 150* washbasin - *Aalto 140* mirror



*Marmor*







**Marmor** 140 White - **Marmor** 140 Carrara basin - **Magnetic** 140 mirror

*Memphis*





*Memphis 80* Angora Grey - *Lao 80* washbasin - *Ilgora* solid mirror - *Ren* shelving units





*Memphis 80 Walnut - Lao 80 washbasin - Ilgora solid mirror - Cubo Walnut shelving units*



*Memphis 130 Walnut - Lao 130 washbasin - Ilargi 120 Solid mirror*



Memphis 130 Petroleum - Lao 130 washbasin - Haruki 120 Solid mirror - Ren 80 Solid shelf



*Tulip*







*Tulip* 240 Tulipier - *Tulpan* 240 washbasin - *Dondo XXL* mirror - *Ren small* Solid shelving units



**Tulip** 120 Tulipier- **Latu** 120 washbasin - **Ilargi** 120 Solid mirror - **Ren** Solid shelving unit - **Tulip** Tulipier wall cabinet



*Grid*







*Grid 108 Oak - Ares 108 washbasin - Elara 100 mirror - Ren 80 Solid shelf*

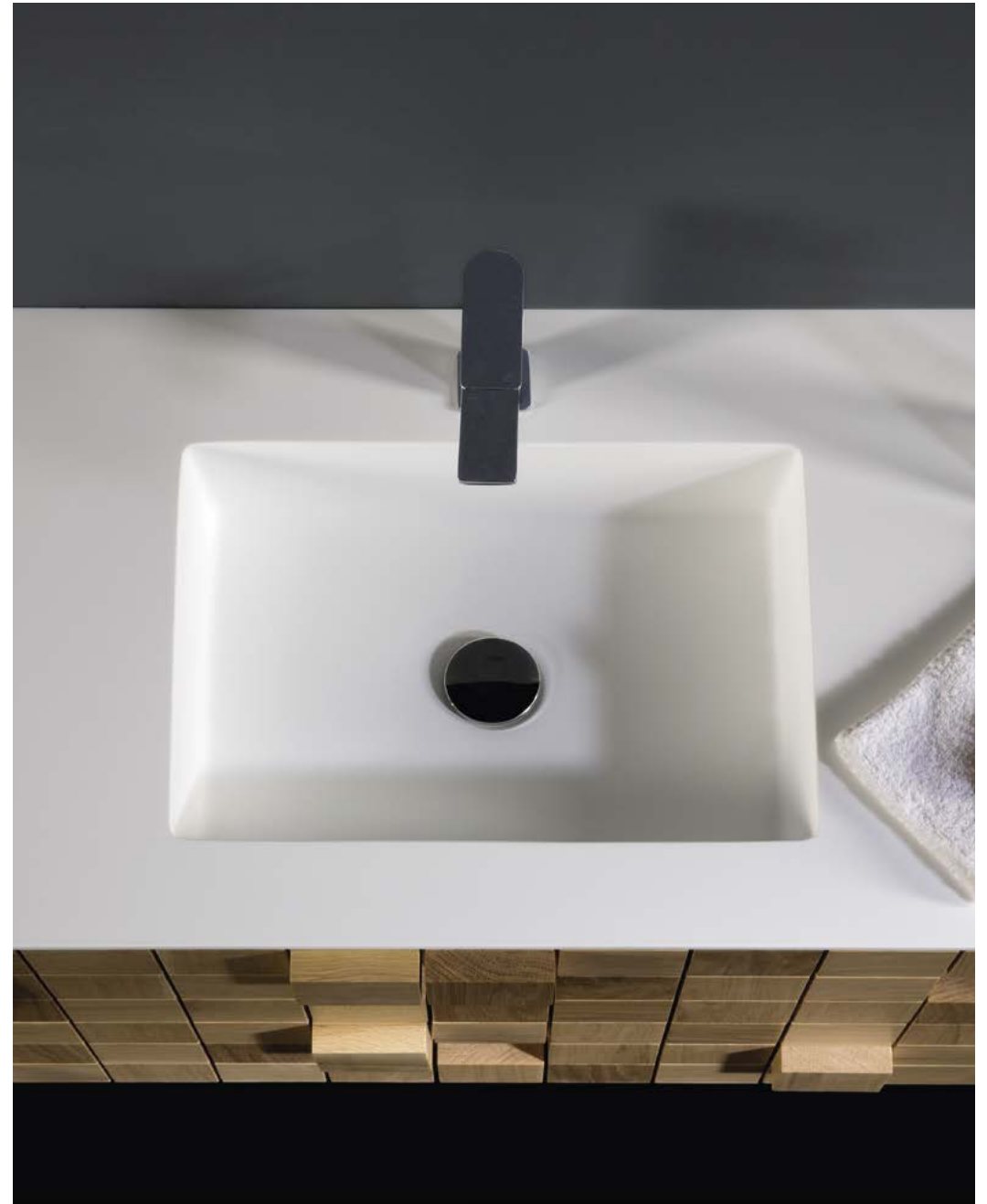

*Aran*



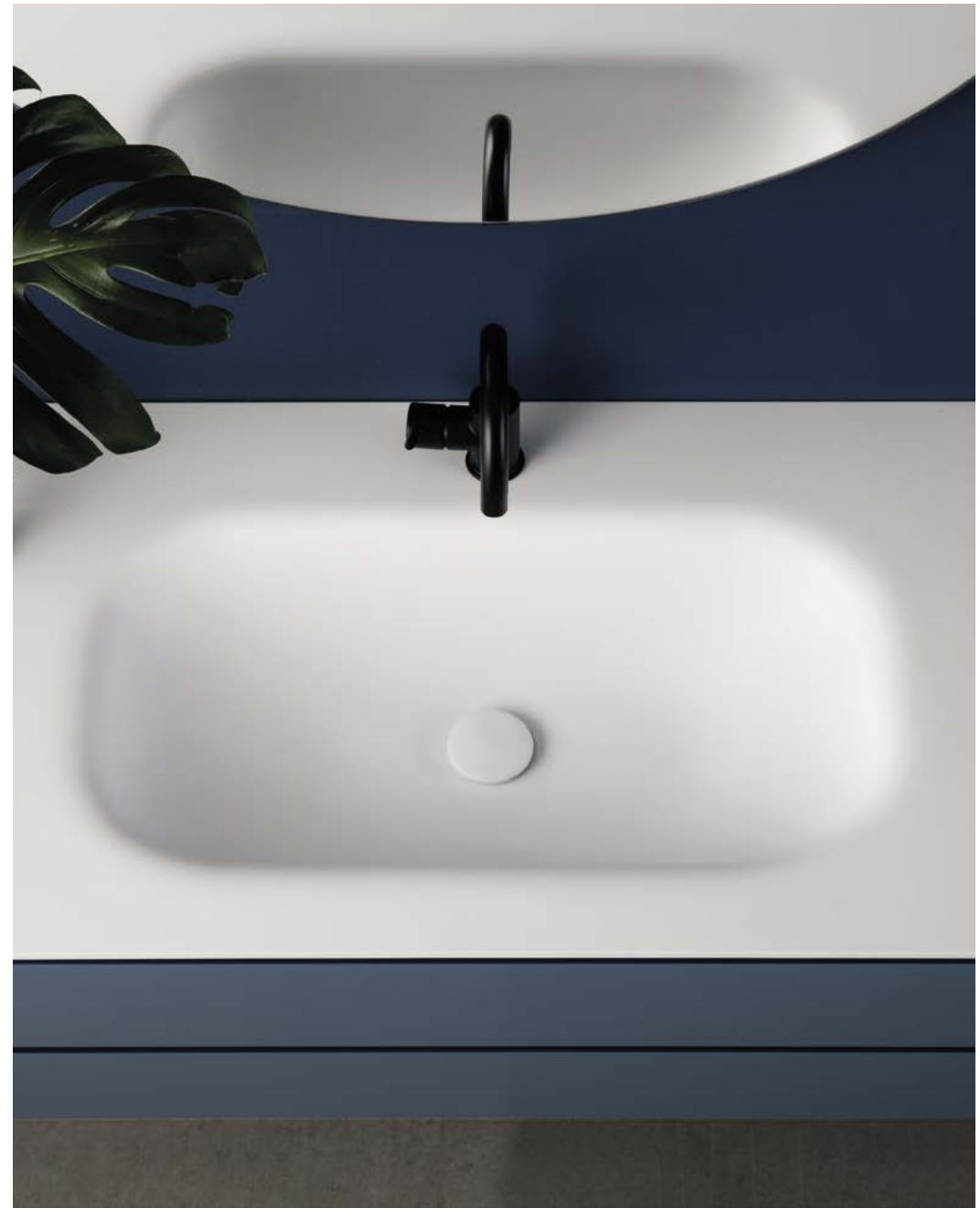

Aran 100 Blue Insta - Forma Small 100 washbasin - Dondo mirror





**Aran** 140 Angora Grey - **Forma Large** 140 washbasin - **Magnetic** 140 mirror - **Ren** 80 Solid shelf - **Nebbe** Angora Grey wall cabinet.



# Boxy



Boxy 160 Ocean - Ares 160 washbasin - Elara 80 mirror - Boxy Mansonia shelf.







**Boxy** 190 Sand - **Ares** 190 washbasin - **Elara** 110 mirror - **Boxy** Mansonia shelf.

# Malmö



Malmö 120 Oak - Lusk 120 washbasin - Malmö Oak mirror



*Puma*







**Puma** Oak wall cabinet



**Puma** 130 Oak - **Puma** washbasin - **Puma** mirror with Solid shelf

# Complements



1. *Cubo* Oak 2. *Doki* White 3. *Ren* 80 Solid shelf



1. *Kondo 3P* Oak 2. *Ren 35* Solid 3. *Ren Small* Solid 4. *Ren 80* Solid 5. *Ren 50* Solid 6. *Doki* white gloss

7-8. *Nebbe* White gloss 9. *Doki mini* Mole



# MUEBLES / MEUBLES / VANITIES

## AALTO [mueble / meuble / vanity]

\***(ES) Ancho a medida (FR) Largeur sur-mesure (EN) Tailored Length.**

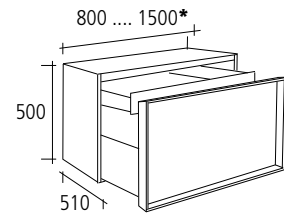

(ES) Madera (FR) Bois (EN) Wood



## ARAN [mueble / meuble / vanity]

\***(ES) Ancho a medida (FR) Largeur sur-mesure (EN) Tailored Length.**

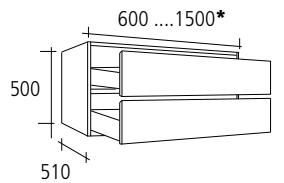

(ES) Brillo (FR) Brillant (EN) Gloss



(ES) Satinado (FR) Satiné (EN) Silk



(ES) Texturado (FR) Texturé (EN) Textured



(ES) Mate (FR) Mat (EN) Matt



## BACALL [mueble / meuble / vanity]

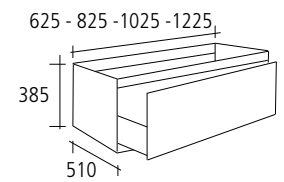

BACALL 1C

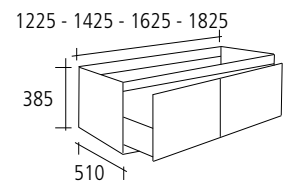

BACALL [1C+1C]

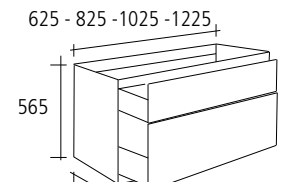

BACALL 2C

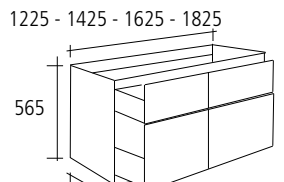

BACALL [2C+2C]

(ES) Madera (FR) Bois (EN) Wood

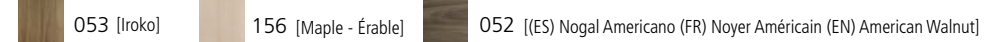

## BANAAVAT [mueble / meuble / vanity]

\***(ES) Ancho a medida (FR) Largeur sur mesure (EN) Tailored Length.**

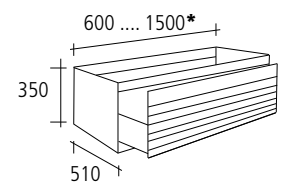

BANAAVAT 1C

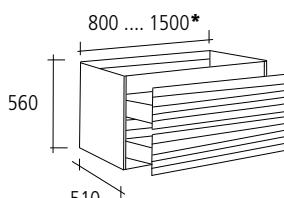

BANAAVAT 2C

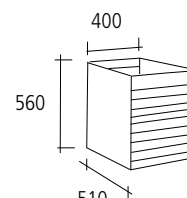

BANAAVAT 1P

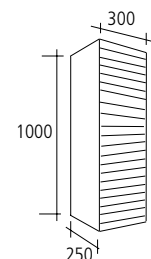

BANAAVAT SEMI. 1P

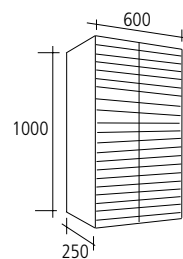

BANAAVAT SEMI. 2P

(ES) Cemento (FR) Béton (EN) Cement

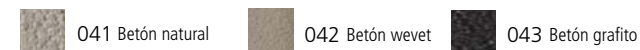

## BATZ [mueble / meuble / vanity]

\***(ES) Ancho a medida (FR) Largeur sur-mesure (EN) Tailored Length.**

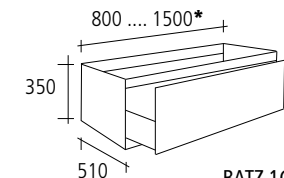

BATZ 1C

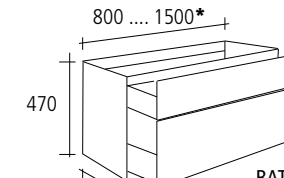

BATZ 2C

(ES) Madera (FR) Bois (EN) Wood



## BERT [mueble / meuble / vanity]

\***(ES) Ancho a medida (FR) Largeur sur-mesure (EN) Tailored Length.**

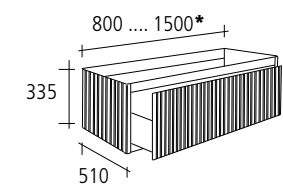

(ES) Satinado (FR) Satiné (EN) Silk



(ES) Texturado (FR) Texturé (EN) Textured



(ES) Mate (FR) Mat (EN) Matt

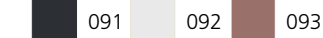

## BOXY [mueble / meuble / vanity]

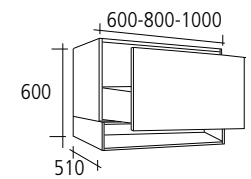

BOXY 1C

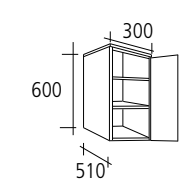

BOXY 30

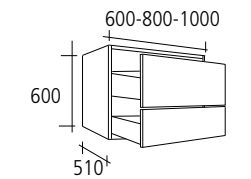

BOXY 2C

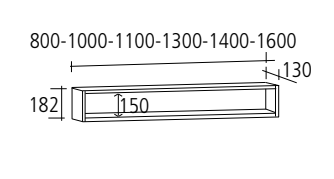

BOXY [ESTANTE - ÉTAGÈRE - SHELF]

(ES) Satinado (FR) Satiné (EN) Silk



(ES) Texturado (FR) Texturé (EN) Textured



(ES) Mate (FR) Mat (EN) Matt



## CHIC [mueble / meuble / vanity]

\***(ES) Ancho a medida (FR) Largeur sur-mesure (EN) Tailored Length.**

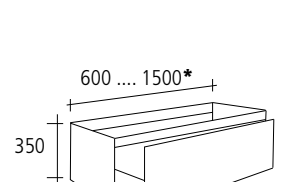

CHIC SEMI. 1P

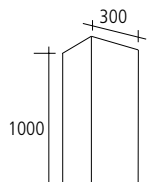

CHIC SEMI. 2P

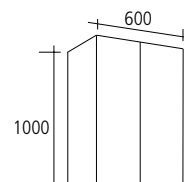

(ES) Satinado (FR) Satiné (EN) Silk



(ES) Texturado (FR) Texturé (EN) Textured



(ES) Mate (FR) Mat (EN) Matt



DOKI MINI [mueble / meuble / vanity]

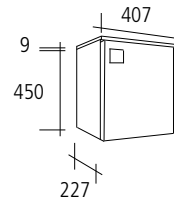

- (ES) Satinado (FR) Satiné (EN) Silk  
 015 117 111 014 115  
 019 011 016 017 027 113
- (ES) Texturado (FR) Texturé (EN) Textured  
 081 082 083 084
- (ES) Mate (FR) Mat (EN) Matt  
 091 092 093

DUMBO [mueble / meuble / vanity]

\*(ES) Ancho a medida (FR) Largeur sur-mesure (EN) Tailored Length.

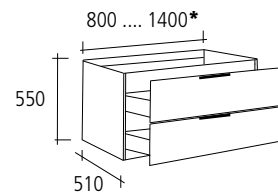

- (ES) Madera (FR) Bois (EN) Wood  
 158 [(ES) Madera tintada (FR) Bois teinté (EN) Stained timber]

ERNIE [mueble / meuble / vanity]

\*(ES) Ancho a medida (FR) Largeur sur-mesure (EN) Tailored Length.

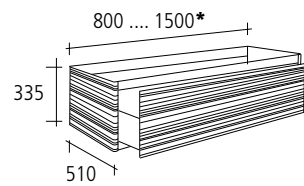

- (ES) Satinado (FR) Satiné (EN) Silk  
 015 117 111 014 115  
 019 011 016 017
- (ES) Texturado (FR) Texturé (EN) Textured  
 081 082 083 084
- (ES) Mate (FR) Mat (EN) Matt  
 091 092 093

GRID [mueble / meuble / vanity]

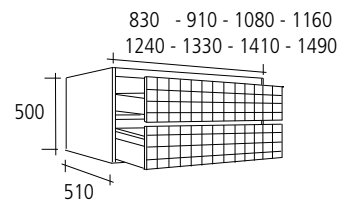

- (ES) Madera (FR) Bois (EN) Wood  
 051 [(ES) Roble Americano (FR) Chêne Américain (EN) American Oak]

HAYEM [mueble / meuble / vanity]

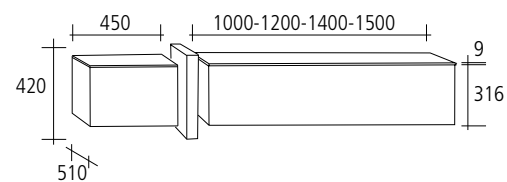

- (ES) Satinado (FR) Satiné (EN) Silk  
 011
- (ES) Brillo (FR) Brillant (EN) Gloss  
 025
- (ES) Madera (FR) Bois (EN) Wood  
 052 [(ES) Nogal Americano (FR) Noyer Américain (EN) American Walnut)]

IGI [mueble / meuble / vanity]

\*(ES) Ancho a medida (FR) Largeur sur-mesure (EN) Tailored Length.

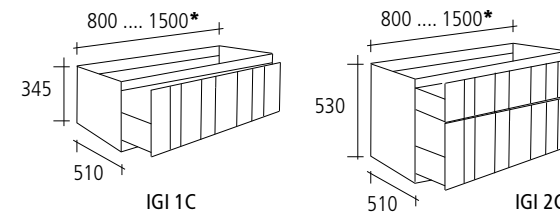

- (ES) Madera (FR) Bois (EN) Wood  
 051 [(ES) Roble Americano (FR) Chêne Américain (EN) American Oak)]

KONDO [mueble columna / wall cabinet / meuble colonne]

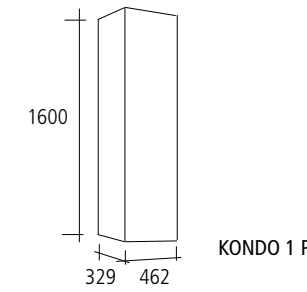

- (ES) Madera (FR) Bois (EN) Wood  
 051 [(ES) Roble Am.(FR) Chêne Am. (EN) Am. Oak]  
 056 [(ES) Fresno (FR) Frêne (EN) Ash]  
 052 [(ES) Nogal Americano (FR) Noyer Américain (EN) American Walnut)]  
 053 [Iroko]  
 156 [Maple -Érable]

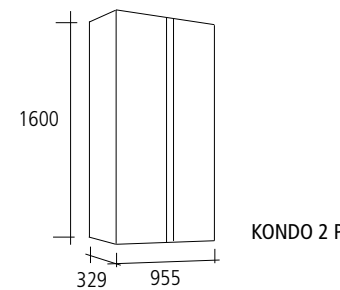

- (ES) Satinado (FR) Satiné (EN) Silk  
 011 117 027 016 019

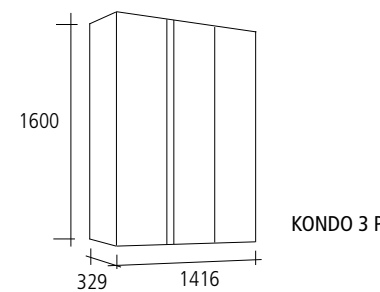

- (ES) Texturado (FR) Texturé (EN) Textured  
 081 082 083 084

- (ES) Mate (FR) Mat (EN) Matt  
 091 092 093

KONDO [módulo / shelving unit / module]

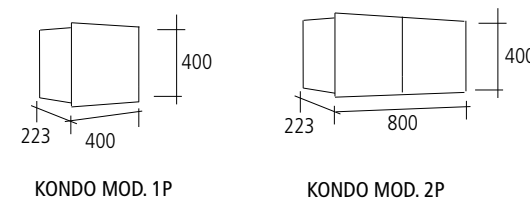

- (ES) Madera (FR) Bois (EN) Wood  
 051 [(ES) Roble Am.(FR) Chêne Am. (EN) Am. Oak]  
 056 [(ES) Fresno (FR) Frêne (EN) Ash]  
 052 [(ES) Nogal Americano (FR) Noyer Américain (EN) American Walnut)]  
 053 [Iroko]  
 156 [Maple -Érable]

LINJER [mueble / meuble / vanity]

\*(ES) Ancho a medida (FR) Largeur sur-mesure (EN) Tailored Length.

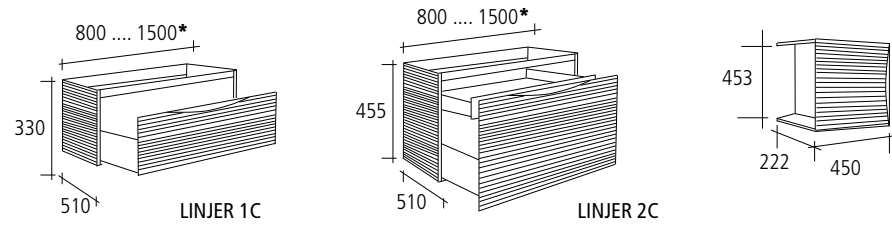

(ES) Madera (FR) Bois (EN) Wood  
 056 [(ES) Fresno (FR) Frêne (EN) Ash]

MALMÖ [mueble / meuble / vanity]

\*(ES) Ancho a medida (FR) Largeur sur-mesure (EN) Tailored Length.

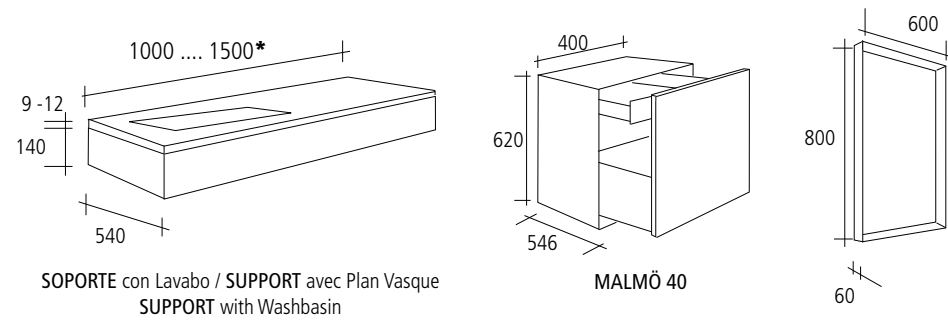

(ES) Madera (FR) Bois (EN) Wood  
 051 [(ES) Roble Am.(FR) Chêne Am. (EN) Am. Oak]

MARMOR [mueble / meuble / vanity]

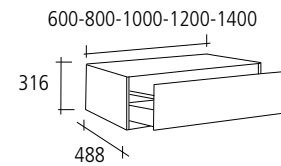

(ES) Brillo (FR) Brillant (EN) Gloss  
 025  
 (ES) Satinado (FR) Satiné (EN) Silk  
 011

MEMPHIS [mueble / meuble / vanity]

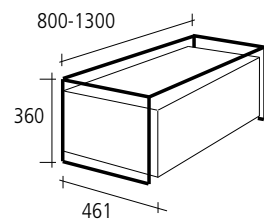

MEMPHIS [ES] con cajonera [FR] avec tiroir [EN] with drawer

(ES) Satinado (FR) Satiné (EN) Silk  
 011 027 017 015 117 111 115 019  
 (ES) Texturado (FR) Texturé (EN) Textured  
 081 082 083 084 (ES) Mate (FR) Mat (EN) Matt  
 091 092 093

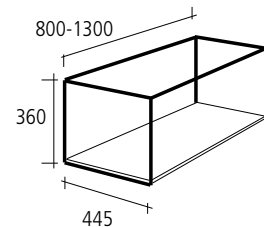

MEMPHIS [es] con estante madera maciza [fr] avec étagère en bois massif [en] with solid wooden shelf

(ES) Madera (FR) Bois (EN) Wood  
 052 [(ES) Nogal Americano (FR) Noyer Américain (EN) American Walnut)]

OSNOVAN [mueble / meuble / vanity]

\*(ES) Ancho a medida (FR) Largeur sur-mesure (EN) Tailored Length.

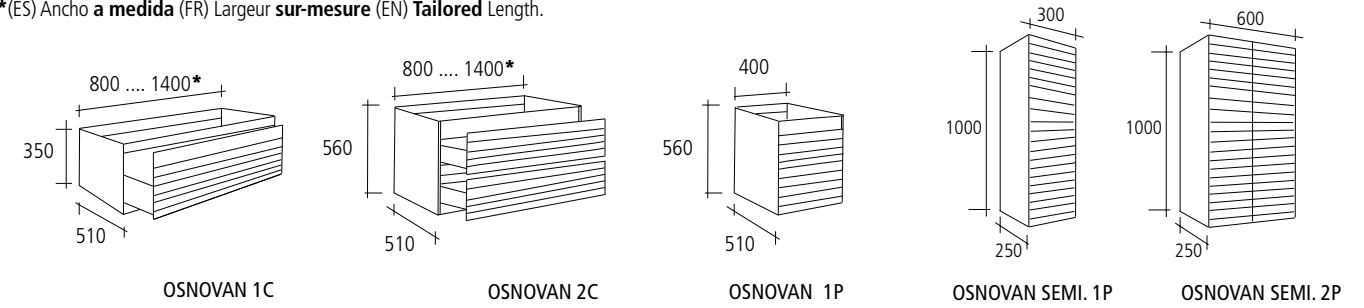

(ES) Satinado (FR) Satiné (EN) Silk  
 019 027 011 016 017  
 (ES) Texturado (FR) Texturé (EN) Textured  
 081 082 083 084 (ES) Mate (FR) Mat (EN) Matt  
 091 092 093  
 015 117 014

PRENN [mueble / meuble / vanity]

\*(ES) Ancho a medida (FR) Largeur sur-mesure (EN) Tailored Length.

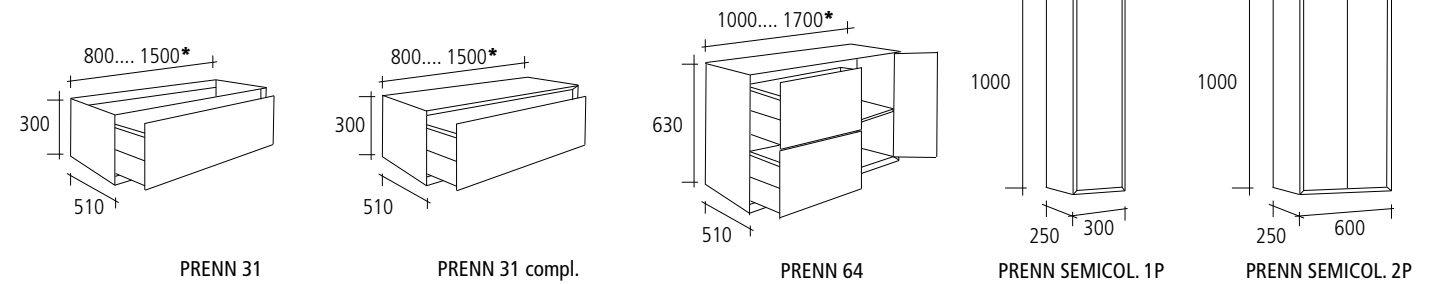

(ES) Madera (FR) Bois (EN) Wood  
 051 [(es) Roble Americano (fr) Chêne Américain (eng) American Oak]  
 052 [(ES) Nogal Americano (FR) Noyer Américain (EN) American Walnut)]  
 053 [Iroko]  
 156 [Maple - Érable]  
 057 [(ES) Fresno quemado (FR) Frêne brûlé (EN) Burned Ash)]

PUMA [mueble / meuble / vanity]

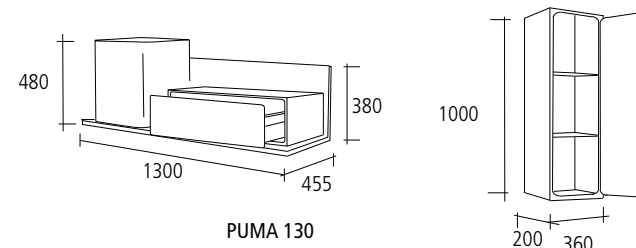

(ES) Frente (FR) Façade (EN) Fronts  
 062 [Pure acrylic stone]  
 (ES) Madera (FR) Bois (EN) Wood  
 051 [(ES) Roble Americano (FR) Chêne Américain (EN) American Oak)]

ROTEN [mueble / meuble / vanity]

\*(ES) Ancho a medida (FR) Largeur sur mesure (EN) Tailored Length.

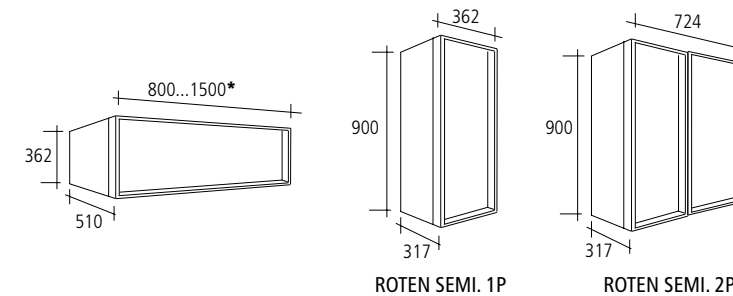

(ES) Satinado (FR) Satiné (EN) Silk  
 011 019  
 (ES) Madera (FR) Bois (EN) Wood  
 056 [(ES) Fresno (FR) Frêne (EN) Ash)]



SHOSUBA [mueble / meuble / vanity]

\*[ES] Ancho **a medida** (FR) Largeur **sur mesure** (EN) **Tailored** Length.

[ES] encimera [FR] plan travail [EN] worktop

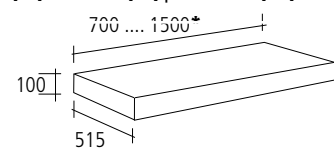

(ES) Madera (FR) Bois (EN) Wood

- 056 [(ES) Fresno (FR) Frêne (EN) Ash]
- 057 [(ES) Fresno quemado (FR) Frêne brûlé (EN) Burned Ash)]

[ES] cajonera [FR] tiroir [EN] drawer

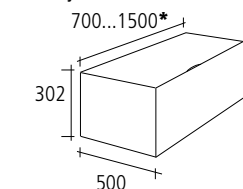

(ES) Satinado (FR) Satiné (EN) Silk

- 011 027 017 015 117 111 115 019

(ES) Texturado (FR) Texturé (EN) Textured

- 081 082 083 084

(ES) Mate (FR) Mat (EN) Matt

- 091 092 093

[ES] 2 puertas [FR] 2 portes [EN] 2 doors

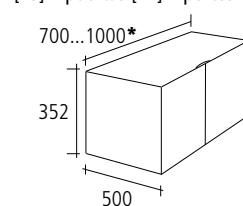

SIMENTA [mueble / meuble / vanity]

\*[ES] Ancho **a medida** (FR) Largeur **sur-mesure** (EN) **Tailored** Length.

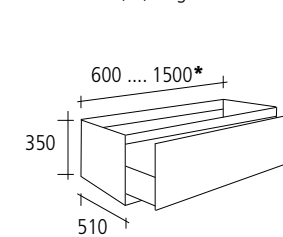

SIMENTA\*

(ES) Cemento (FR) Béton (EN) Cement

- 041 Betón natural
- 042 Betón wevet
- 043 Betón grafito

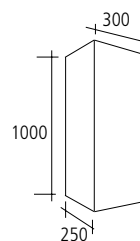

SIMENTA SEMI. 1P

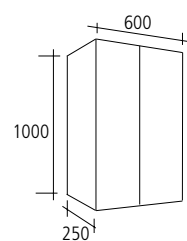

SIMENTA SEMI. 2P

SLAT [mueble / meuble / vanity]

\*[ES] Ancho **a medida** (FR) Largeur **sur mesure** (EN) **Tailored** Length.

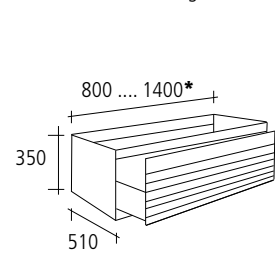

SLAT 1C\*

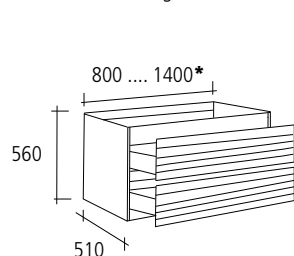

SLAT 2C\*

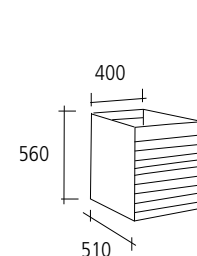

SLAT 1P

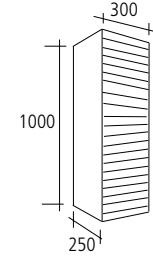

SLAT SEMI. 1P

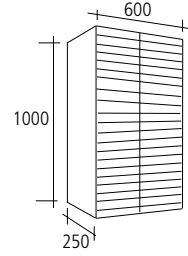

SLAT SEMI. 2P

(ES) Madera (FR) Bois (EN) Wood

- 051 [(ES) Roble Am.(FR) Chêne Am. (EN) Am. Oak]
- 053 [Iroko]
- 052 [(ES) Nogal Americano (FR) Noyer Américain (EN) American Walnut]
- 056 [(ES) Fresno (FR) Frêne (EN) Ash]
- 156 [Maple - Érable]

SURÓ [mueble / meuble / vanity]

\*[ES] Ancho **a medida** (FR) Largeur **sur mesure** (EN) **Tailored** Length.

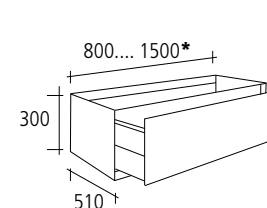

SURÓ 31

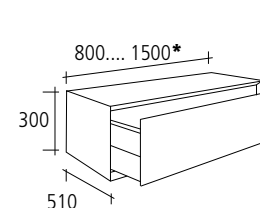

SURÓ 31 compl.

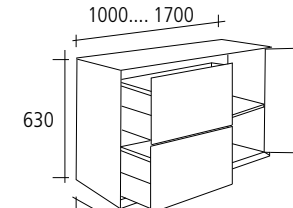

SURÓ 64

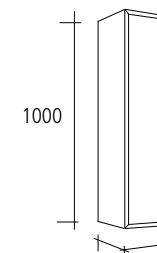

SURÓ SEMICOL. 1P

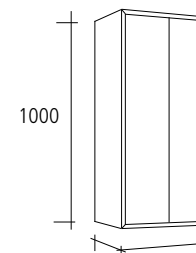

SURÓ SEMICOL. 2P

(ES) Madera (FR) Bois (EN) Wood

- 158 [(ES) Fresno ahumado (FR) Ash fumé (EN) Smoked Ash)]

TULIP [mueble / meuble / vanity]

\*[ES] Ancho **a medida** (FR) Largeur **sur mesure** (EN) **Tailored** Length.

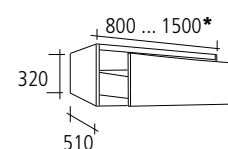

TULIP

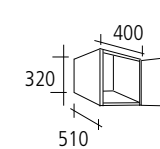

TULIP COMPL.

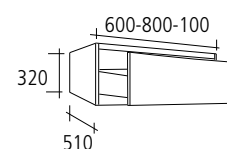

TULIP COMPL.

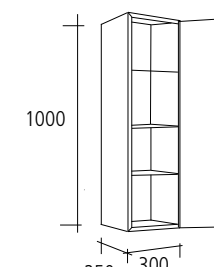

TULIP SEMI. 1P

(ES) Madera (FR) Bois (EN) Wood

- 055 [ tulipier ]

UNDA [mueble / meuble / vanity]

\*[ES] Ancho **a medida** (FR) Largeur **sur mesure** (EN) **Tailored** Length.

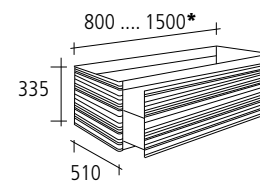

(ES) Madera (FR) Bois (EN) Wood

- 052 [(ES) Nogal Americano (FR) Noyer Américain (EN) American Walnut]
- 056 [(ES) Fresno (FR) Frêne (EN) Ash]
- 156 [Maple - Érable]

VALNÖT [mueble / meuble / vanity]

\*[ES] Ancho **a medida** (FR) Largeur **sur mesure** (EN) **Tailored** Length.

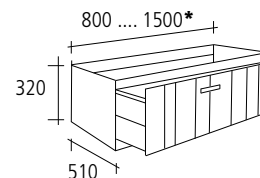

(ES) Madera (FR) Bois (EN) Wood

- 052 [ (es) Nogal Americano (fr) Noyer Américain (eng) American Walnut ]

# COMPLEMENTOS / COMPLEMENTS

## CUBO [accesorios / accessories / accessoires]

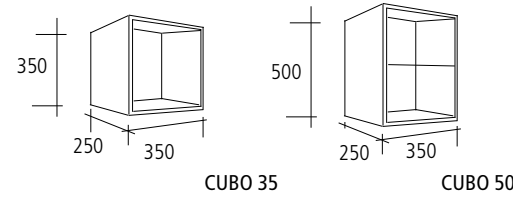

- (ES) Madera (FR) Bois (EN) Wood
- 051 [(ES) Roble Americano (FR) Chêne Américain (EN) American Oak]
  - 052 [(ES) Nogal Americano (FR) Noyer Américain (EN) American Walnut)]

## NEBBE [accesorios / accessories / accessoires]

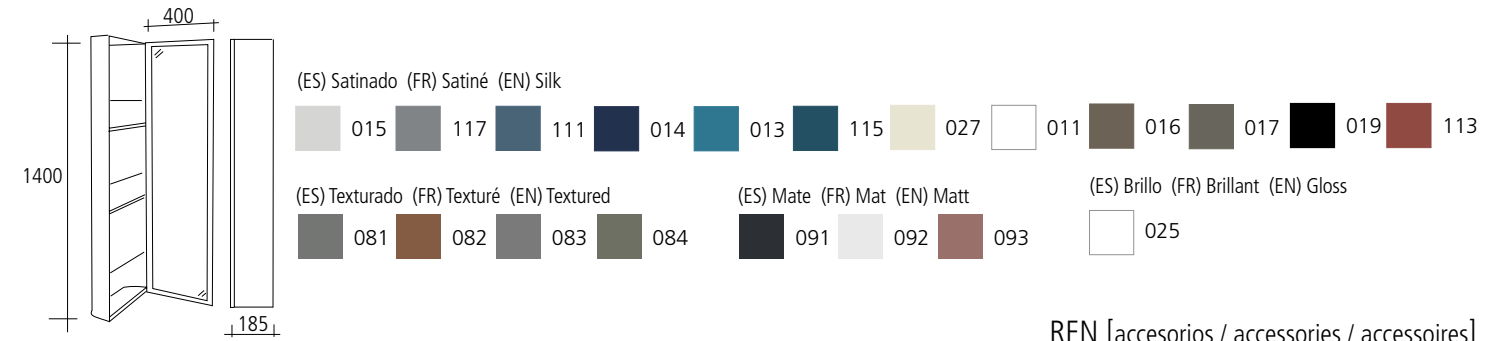

- (ES) Satinado (FR) Satiné (EN) Silk
- 015 117 111 014 013 115 027 011 016 017 019 113
- (ES) Texturado (FR) Texturé (EN) Textured
- 081 082 083 084
- (ES) Mate (FR) Mat (EN) Matt
- 091 092 093
- (ES) Brillo (FR) Brillant (EN) Gloss
- 025

## DOKI [accesorios / accessories / accessoires]

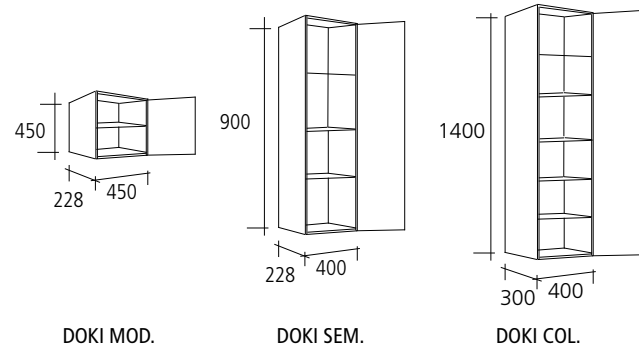

- (ES) Brillo (FR) Brillant (EN) Gloss
- 025
- (ES) Satinado (FR) Satiné (EN) Silk
- 015 117 111 014 013 115 027 011 016 017 019 113
- (ES) Mate (FR) Mat (EN) Matt
- 091 092 093
- (ES) Texturado (FR) Texturé (EN) Textured
- 081 082 083 084

## REN [accesorios / accessories / accessoires]

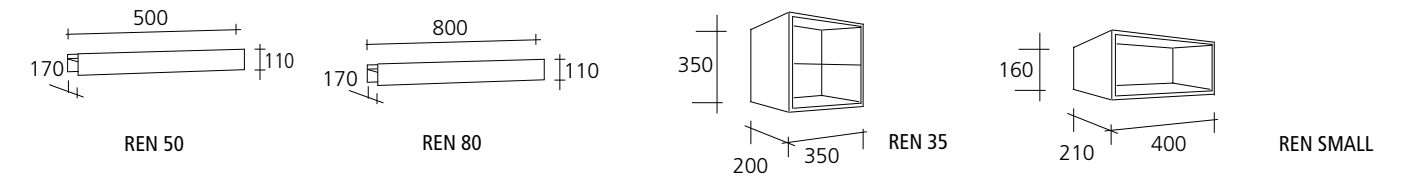

# ESPEJOS / MIRRORS / MIROIRS

## AALTO [espejo / mirror / miroir]

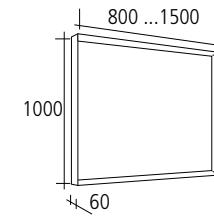

- (ES) Madera (FR) Bois (EN) Wood
- 051 [(ES) Roble Am.(FR) Chêne Am. (EN) Am. Oak]
  - 056 [(ES) Fresno (FR) Frêne (EN) Ash]
  - 052 [(ES) Nogal Americano (FR) Noyer Américain (EN) American Walnut)]
  - 053 [Iroko]
  - 156 [Maple - Érable]

## KONDO [mueble columna / wall cabinet / meuble colonne]

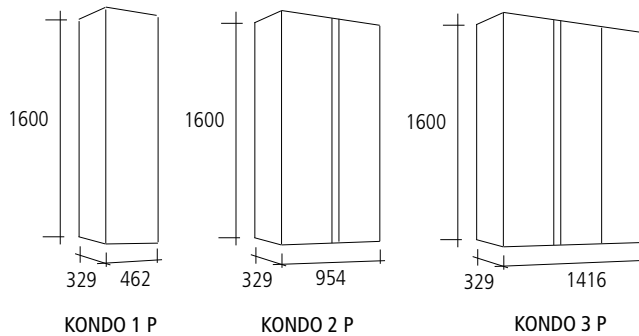

- (ES) Madera (FR) Bois (EN) Wood
- 051 [(ES) Roble Am.(FR) Chêne Am. (EN) Am. Oak]
  - 056 [(ES) Fresno (FR) Frêne (EN) Ash]
  - 052 [(ES) Nogal Americano (FR) Noyer Américain (EN) American Walnut)]
  - 053 [Iroko]
  - 156 [Maple - Érable]
- (ES) Satinado (FR) Satiné (EN) Silk
- 011 117 027 016 019
- (ES) Texturado (FR) Texturé (EN) Textured
- 081 082 083 084
- (ES) Mate (FR) Mat (EN) Matt
- 091 092 093

## KONDO [módulo / shelving unit / module]

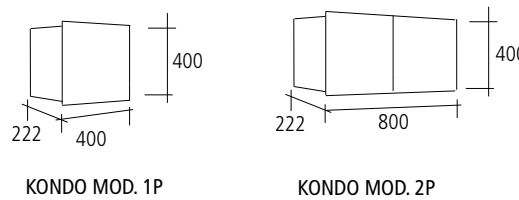

- (ES) Madera (FR) Bois (EN) Wood
- 051 [(ES) Roble Am.(FR) Chêne Am. (EN) Am. Oak]
  - 056 [(ES) Fresno (FR) Frêne (EN) Ash]
  - 052 [(ES) Nogal Americano (FR) Noyer Américain (EN) American Walnut)]
  - 053 [Iroko]
  - 156 [Maple - Érable]

## CALLISTO [espejo / mirror / miroir]

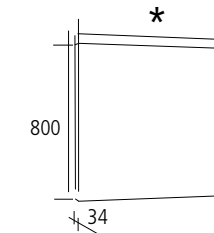

\* 600-700-800-900-1000-1100-1200-1300-1400-1500

[ES] Espejo con retroiluminación LED y sistema de difusión de la luz / Sistema antivaho.  
 [EN] Mirror with Led backlight / Tactile switch system to switch on/off the lighting.  
 [FR] Miroir avec rétroéclairage Led / Interrupteur tactile.

## CAPITON [espejo / mirror / miroir]

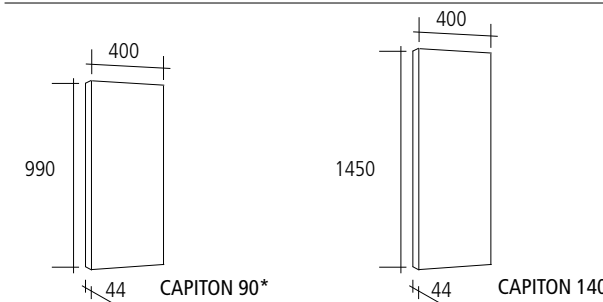

[ES] Sistema antivaho\*  
 [EN] No steam-system\*  
 [FR] Système antibuée\*

## DONDO [espejo / mirror / miroir]

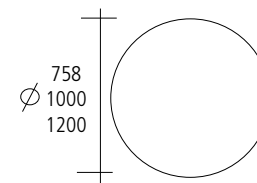

[ES] Sistema antivaho - Sensor para apagar/encender la luz.  
 [EN] Tactile switch system to switch on/off the lighting - No steam-system.  
 [FR] Interrupteur tactile - Système antibuée.

ELARA [espejo / mirror / miroir]

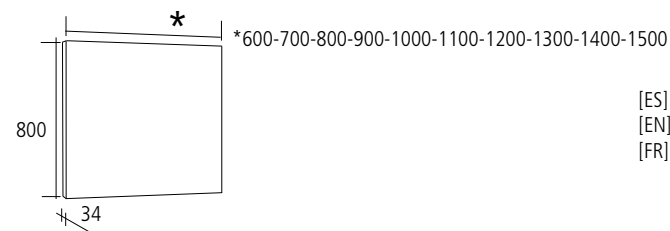

[ES] Sistema antivaho - Sensor para apagar/encender la luz.  
 [EN] Tactile switch system to switch on/off the lighting - No steam-system.  
 [FR] Interrupteur tactile - Système antibuée.

ERIS [espejo / mirror / miroir]

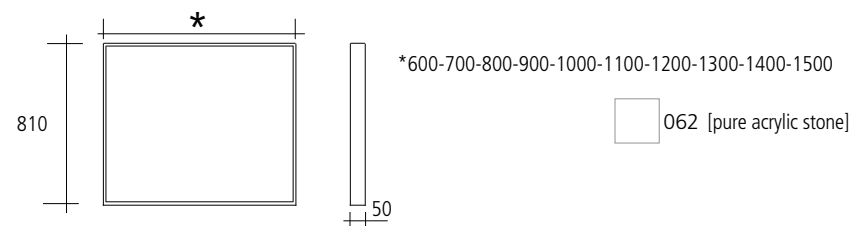

HARUKI [espejo / mirror / miroir]



[ES] Espejo con retroiluminación LED y sistema de difusión de la luz.  
 Sensor para apagar/encender la luz.  
 [EN] Mirror with Led backlight  
 Tactile switch system to switch on/off the lighting  
 [FR] Miroir avec rétroéclairage Led  
 Interrupteur tactile.

ILARGI [espejo / mirror / miroir]

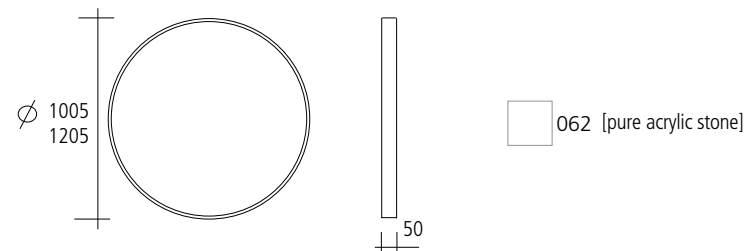

ILGORA [espejo / mirror / miroir]

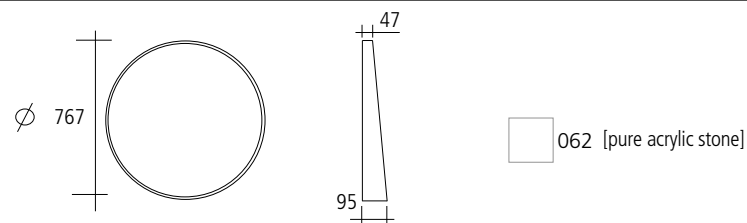

MAGNETIC [espejo / mirror / miroir]

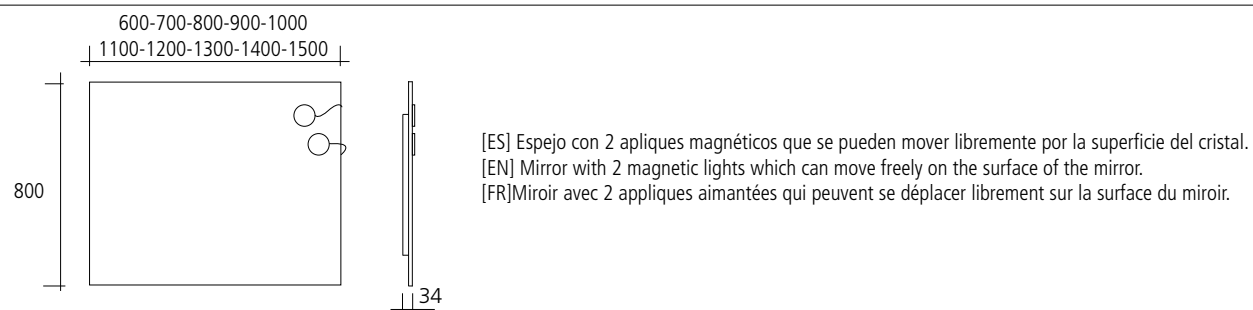

[ES] Espejo con 2 apliques magnéticos que se pueden mover libremente por la superficie del cristal.  
 [EN] Mirror with 2 magnetic lights which can move freely on the surface of the mirror.  
 [FR] Miroir avec 2 appliques aimantées qui peuvent se déplacer librement sur la surface du miroir.

NOU [espejo / mirror / miroir]

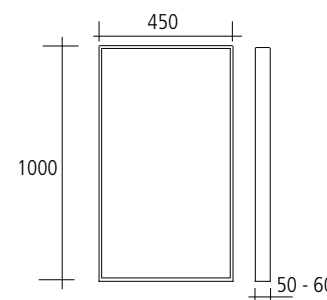

(ES) Madera (FR) Bois (EN) Wood

- 051 [(ES) Roble Am.(FR) Chêne Am. (EN) Am. Oak]
- 056 [(ES) Fresno (FR) Frêne (EN) Ash]
- 052 [(ES) Nogal Americano (FR) Noyer Américain (EN) American Walnut]
- 053 [Iroko]
- 156 [Maple - Érable]
- 158 [(ES) Fresno ahumado (FR) Ash fumé (EN) Smoked Ash]
- 058 [(ES) Madera tintada (FR) Bois teinté (EN) Stained timber)]

062 [pure acrylic stone]

PUMA [espejo / mirror / miroir]

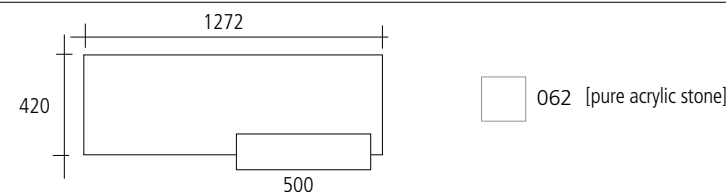

PRENN [espejo / mirror / miroir]

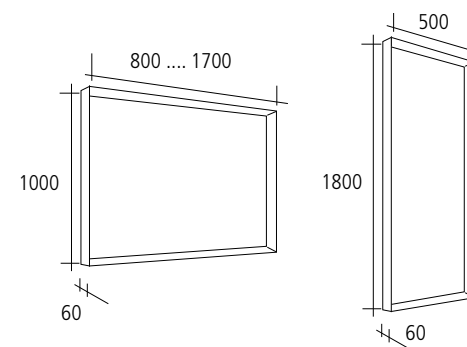

(ES) Madera (FR) Bois (EN) Wood

- 051 [(ES) Roble Americano (FR) Chêne Américain (EN) American Oak]
- 052 [(ES) Nogal Americano (FR) Noyer Américain (EN) American Walnut]
- 053 [Iroko]
- 156 [Maple - Érable]

SLOPE [espejo / mirror / miroir]

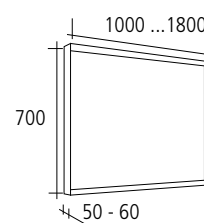

(ES) Madera (FR) Bois (EN) Wood

- 051 [(ES) Roble Am.(FR) Chêne Am. (EN) Am. Oak]
- 056 [(ES) Fresno (FR) Frêne (EN) Ash]
- 052 [(ES) Nogal Americano (FR) Noyer Américain (EN) American Walnut]
- 058 [(ES) Madera tintada (FR) Bois teinté (EN) Stained timber)]
- 053 [Iroko]
- 156 [Maple - Érable]

062 [pure acrylic stone]

SURÓ [espejo / mirror / miroir]

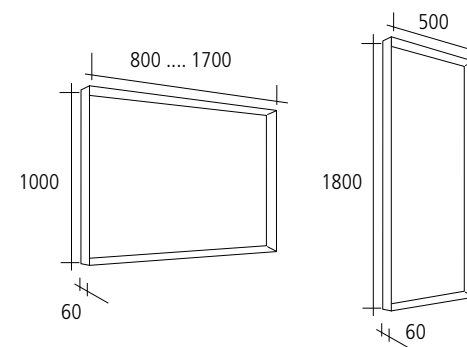

(ES) Madera (FR) Bois (EN) Wood

- 158 [(ES) Fresno ahumado (FR) Ash fumé (EN) Smoked Ash)]



# LAVABOS / PLAN VASQUES / WASHBASINS

ALMA [solid surface]

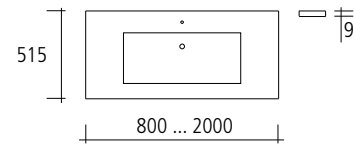

ARES [solid surface]

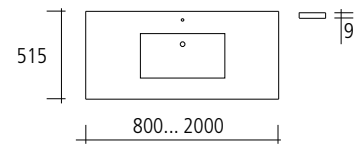
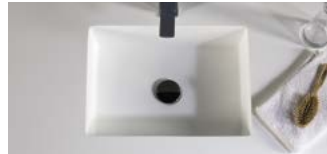

ARAN [solid surface]

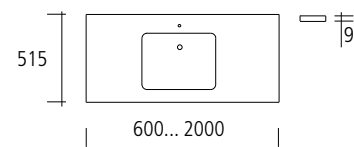

INIS [solid surface]

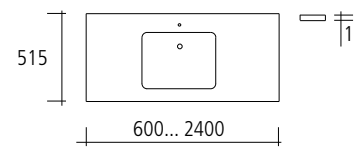

DARO [solid surface]

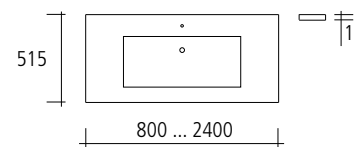

LATU [solid surface]

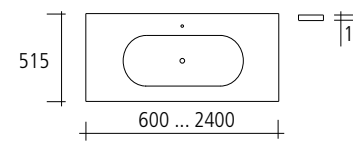

2R [solid surface]

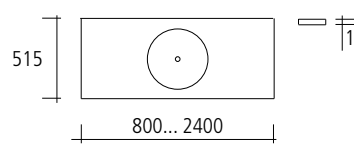

FORMA LARGE [solid surface]

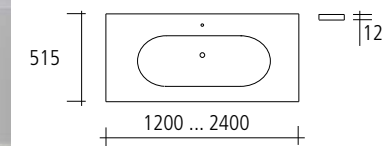

FORMA SMALL [solid surface]

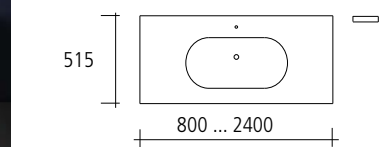

BORVO [solid surface]

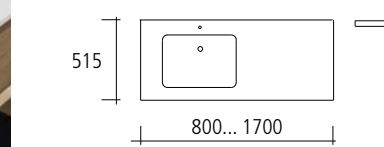

PRENN [solid surface]

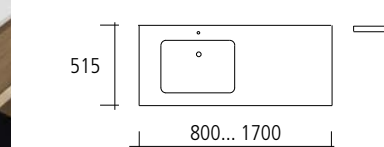

PATRA [solid surface]

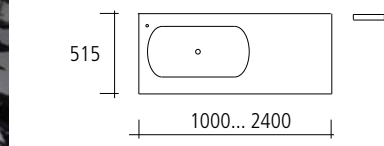

TULPAN [solid surface]

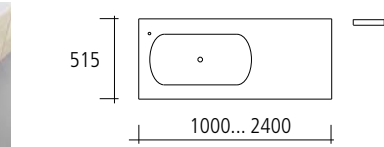

SQUARE [solid surface]

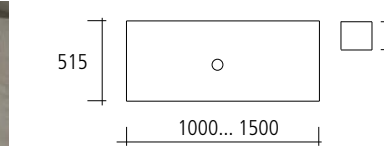

CLERC [solid surface]

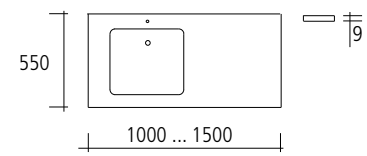

LUSK [solid surface]

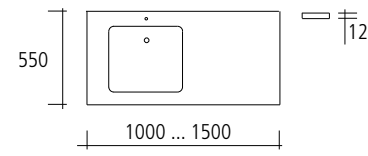

BIHAN [solid surface]

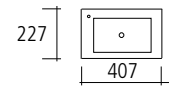

[ES] Compatible con la serie DOKI MINI.  
 [EN] Compatible with DOKI MINI collection.  
 [FR] Compatible avec la série DOKI MINI.

PUMA [solid surface]

[ES] Compatible con la serie PUMA 130.  
 [EN] Compatible with PUMA 130 collection.  
 [FR] Compatible avec la série PUMA 130.

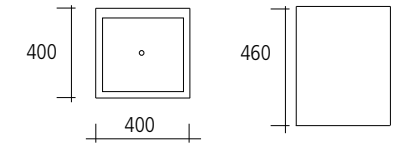

PRIM [solid surface]

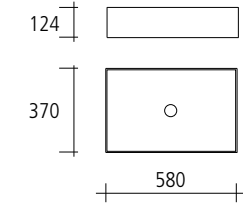

RODÓ [solid surface]

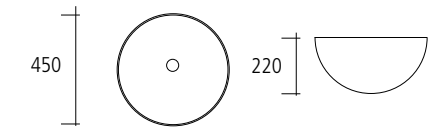

**LAVABOS / VASQUES / BASINS**

1Q84 [solid surface]

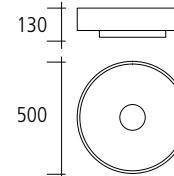

HIRGA [cerámica / ceramic / ceramique]

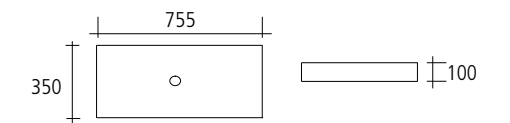

NIT [solid surface]

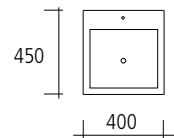

OVUM [cerámica / ceramic / ceramique]

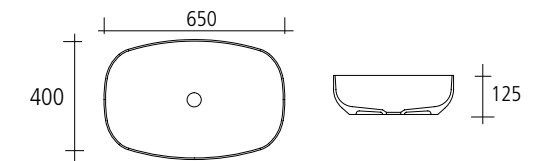

OFALI [solid surface]

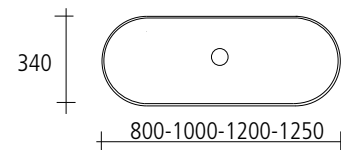

OVAL [solid surface]

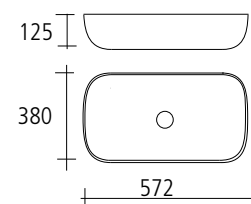

**LAVABOS DE MÁRMOL NATURAL / PLAN VASQUE MARBRE NATUREL / NATURAL MARBLE WASHBASIN**

MARMOR

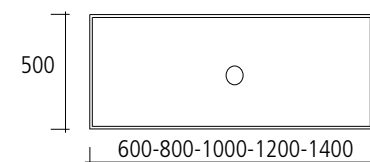

[ES] Compatible con la serie MARMOR.  
 [EN] Compatible with MARMOR collection.  
 [FR] Compatible avec la série MARMOR.

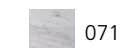

# ACABADOS / FINITIONS / FINISHINGS

[ES] Lacado satinado [FR] Laques satinées [EN] Silk lacquered

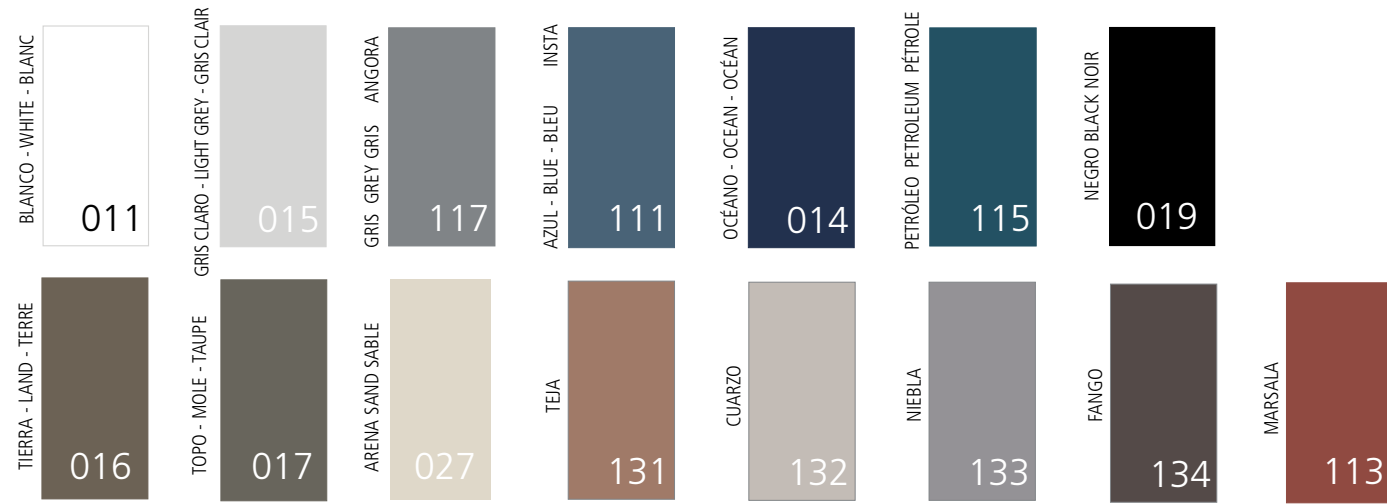

[ES] Rechapados [FR] Placages bois [EN] Veneer



[ES] Tablero marino [FR] Contreplaqués marine [EN] Plywood



[ES] Lacado brillo [FR] Laques brillantes [EN] Gloss lacquered

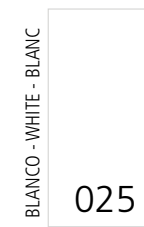

[ES] Lacado mate [FR] Lacques mates [EN] Matt lacquered

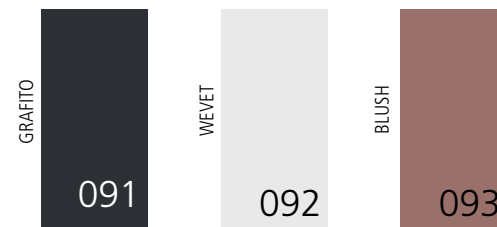

[ES] Cemento [FR] Beton [EN] Cement



[ES] Lacados texturados [FR] Laques texturées [EN] Textured finishes

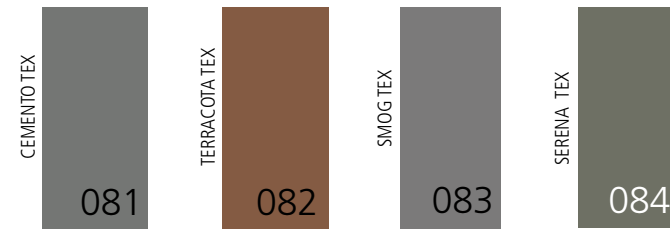

[ES] Maderas macizas [FR] Bois massif [EN] Solid Wood.



[ES] Mármol natural [FR] Marbre naturel [EN] Natural marble

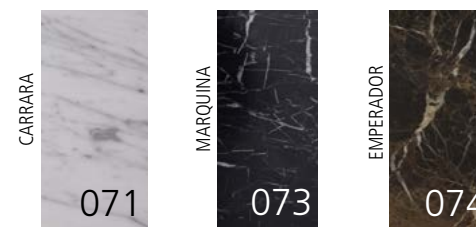

## SU COLOR A MEDIDA.

Si no encuentra el color que está buscando Naxani le ofrece acabar su mueble con el color de la carta RAL ó NCS que desee. Consultenos el PVP y plazo de entrega.

## COULEURS SUR DEMANDE.

Si les couleurs de série ne vous conviennent pas, Naxani vous propose de choisir une couleur de la carte RAL ou NCS. Nous consulter pour le prix et le délai.

## YOUR COLOUR TO ORDER.

If you don't find the colour you want, Naxani offers to finish your unit to any colour from the RAL or NCS colour chart. Ask us for the price and delivery time.



# ILUMINACIÓN / ÉCLAIRAGE / LIGHTING

HARUKI  
Led IP65



CALLISTO  
Led IP65



NIKI  
Led IP44  
10 W



MAGNETIC  
Led IP44  
2x3,5 W



ODET XXL  
800 mm  
Led IP44  
15 W



ODET XL  
608 mm  
Led IP44  
12 W



ODET L  
458 mm  
Led IP44  
10 W



DEVA  
Led IP44  
5,5 W



Product Design: Begoña Povo. Naxani lab  
Printed by: Logik Graphics.

## MADE IN SPAIN

### **Naxani Design SL**

Headquarters  
Av. de la libertad 38  
Alzira (Valencia) **Spain**

T. +34 962 456 363  
info@naxani.com

### **Naxani Export**

Commercial office.  
20 allée des petits Brivins  
44500 La Baule **France**

T. +33 240 662 590  
info@naxani.com

**[www.naxani.com](http://www.naxani.com)**

Los datos y características indicados en este catálogo no son vinculantes.  
NAXANI DESIGN SL se reserva los derechos de cualquier modificación técnica y/o estética sin previo aviso.  
Para especificaciones técnicas o medidas exactas les rogamos contacten con nuestro departamento comercial.  
Los colores de los materiales y acabados son sólo indicativos.  
Los productos del catálogo están sujetos a la Ley de Protección Jurídica del Diseño Industrial, siendo Naxani el propietario del Diseño Industrial de los mismos, registrados en la Oficina Europea de Patentes y Marcas.

Les données et caractéristiques indiquées dans ce catalogue ne sont pas contractuelles.  
NAXANI DESIGN SL se réserve le droit de tout changement technique ou esthétique sans préavis.  
Pour obtenir une dimension précise ou une spécificité technique, vous devez contacter notre département commercial.  
Les couleurs et finitions sont donnés à titre indicatif.  
Les produits du catalogue sont la propriété de Naxani et enregistrés à l'Office de l'Union Européenne pour la propriété intellectuelle.

The information and characteristics specified in this catalogue are not binding.  
NAXANI DESIGN SL reserves the right to make any modifications without the obligation to give notice thereof.  
Please contact our commercial department for technical specifications or exact measurements.  
Colours of materials and finishes are only indicative.  
All copyrights and intellectual property rights, including trademarks, and Industrial Design, remain the property of Naxani and are explicitly reserved on the European Union Intellectual Property Office.

# NAXANI

Naxani Design SL  
Valencia, Spain

T. +34 962 456 363  
[info@naxani.com](mailto:info@naxani.com)

[www.naxani.com](http://www.naxani.com)