

Galimberti Nino

NUOVO  
CLAS  
SICO  
MILANESE

VOLUME 1  
ENGLISH

NUOVO  
CLAS  
SICO  
MILANESE

Galimberti Nino

11/2022

<b>DINING TABLES</b>	<b>p. 10</b>	>
<b>CHAIRS</b>	<b>p. 11</b>	>
<b>SOFAS</b>	<b>p. 13</b>	>
<b>ARMCHAIRS AND OTTOMANS</b>	<b>p. 15</b>	>
<b>COFFEE AND SIDE TABLES</b>	<b>p. 18</b>	>
<b>CONSOLES</b>	<b>p. 20</b>	>
<b>DESKS</b>	<b>p. 21</b>	>
<b>VANITY TABLES</b>	<b>p. 22</b>	>
<b>BOOKCASES</b>	<b>p. 23</b>	>
<b>STORAGES</b>	<b>p. 24</b>	>
<b>NIGHT STORAGES</b>	<b>p. 26</b>	>
<b>BEDS</b>	<b>p. 28</b>	>
<b>COMPLEMENTARY FURNITURE</b>	<b>p. 29</b>	>
<b>CUSHIONS</b>		>
<b>MATTRESSES</b>		>

<b>ACQUAMARINA</b> / CLUB CHAIR	<b>p. 304</b>	>
<b>ADELE</b> / DINING ARM CHAIR	<b>p. 208</b>	>
<b>AMBRA</b> / BENCH	<b>p. 290</b>	>
<b>AMBRA</b> / COFFEE TABLE	<b>p. 278</b>	>
<b>AMBRA</b> / DESK	<b>p. 296</b>	>
<b>AMBRA</b> / NIGHT TABLE · CHEST OF DRAWERS	<b>p. 280</b>	>
<b>AMBRA</b> / STORAGEES	<b>p. 264</b>	>
<b>AMBRA</b> / VANITY TABLE	<b>p. 292</b>	>
<b>ANDRÈ</b> / SIDE TABLE	<b>p. 222</b>	>
<b>ANEMONE</b> / OTTOMAN	<b>p. 310</b>	>
<b>ANEMONE</b> / SOFA	<b>p. 308</b>	>
<b>ARGO</b> / NIGHT TABLE · LOUNGE TABLE	<b>p. 234</b>	>
<b>ASMARA</b> / NIGHT TABLE · CHEST OF DRAWERS	<b>p. 356</b>	>
<b>ASMARA</b> / SIDEBOARD	<b>p. 32</b>	>
<b>ASTRID</b> / WALL MIRROR	<b>p. 362</b>	>
<b>BIRKIN</b> / DINING CHAIR	<b>p. 220</b>	>
<b>BRIGITTA</b> / ARMCHAIR	<b>p. 426</b>	>
<b>CAMELIA</b> / ARMCHAIR	<b>p. 312</b>	>
<b>CAMELIA</b> / COFFEE TABLE	<b>p. 318</b>	>

<b>CHARLI</b> / SIDE TABLE	<b>p. 166</b>	>
<b>COLETTE</b> / DINING CHAIR	<b>p. 218</b>	>
<b>CORALLO</b> / DINING TABLE	<b>p. 322</b>	>
<b>DILETTA</b> / DINING ARM CHAIR	<b>p. 46</b>	>
<b>DOLCEVITA</b> / BENCH	<b>p. 432</b>	>
<b>DOLCEVITA</b> / COFFEE TABLE · SIDE TABLE	<b>p. 444</b>	>
<b>DOLCEVITA</b> / DINING TABLE	<b>p. 448</b>	>
<b>DOLCEVITA</b> / NIGHT TABLE · CHEST OF DRAWERS	<b>p. 428</b>	>
<b>DOLCEVITA</b> / SHOWCASE · SIDEBOARD	<b>p. 438</b>	>
<b>DOLCEVITA</b> / VANITY TABLE	<b>p. 436</b>	>
<b>EDMOND</b> / SOFA	<b>p. 364</b>	>
<b>EGLE</b> / DINING CHAIR	<b>p. 204</b>	>
<b>ELIODORO</b> / ARMCHAIR	<b>p. 302</b>	>
<b>ELIODORO</b> / SOFA	<b>p. 298</b>	>
<b>ELLIOT</b> / BED	<b>p. 368</b>	>
<b>ELLIOT DECÒ</b> / BED	<b>p. 372</b>	>
<b>FERRANDO</b> / COFFEE TABLE · SIDE TABLE	<b>p. 328</b>	>
<b>FERRANDO</b> / CONSOLE	<b>p. 334</b>	>
<b>GEMMA</b> / DINING CHAIR · DINING ARM CHAIR	<b>p. 336</b>	>



<b>GILDA</b> / DINING CHAIR	<b>p. 340</b>	>
<b>GILDA COVER</b> / DINING CHAIR	<b>p. 344</b>	>
<b>GIORGIO</b> / CLUB CHAIR	<b>p. 124</b>	>
<b>GIORGIO</b> / SOFA · SOFA BED	<b>p. 120</b>	>
<b>HIRO</b> / DINING TABLE	<b>p. 214</b>	>
<b>HOLLYWOOD</b> / CLUB CHAIR	<b>p. 380</b>	>
<b>HOLLYWOOD</b> / SOFA	<b>p. 374</b>	>
<b>HUGO</b> / CHAISE LONGUE	<b>p. 392</b>	>
<b>HUGO</b> / CLUB CHAIR · OTTOMAN	<b>p. 396</b>	>
<b>HUGO</b> / SOFA · MODULAR SOFA	<b>p. 384</b>	>
<b>JACOB</b> / BED	<b>p. 400</b>	>
<b>JACQUES</b> / COFFEE TABLE	<b>p. 118</b>	>
<b>JOLO</b> / BED	<b>p. 404</b>	>
<b>JULIETTE</b> / CLUB CHAIR	<b>p. 162</b>	>
<b>JULIETTE</b> / SMALL OTTOMAN	<b>p. 164</b>	>
<b>KELLY</b> / BED	<b>p. 460</b>	>
<b>KELLY</b> / CLUB CHAIR	<b>p. 458</b>	>
<b>KELLY</b> / SOFA	<b>p. 452</b>	>
<b>KOBE</b> / DESK	<b>p. 156</b>	>

<b>KUBBU</b> / OTTOMAN	<b>p. 408</b>	>
<b>LADONE</b> / BED	<b>p. 130</b>	>
<b>LIRICA</b> / CONSOLE	<b>p. 126</b>	>
<b>LUCY</b> / CHAIR	<b>p. 232</b>	>
<b>LUMIÈRE</b> / CONSOLE	<b>p. 414</b>	>
<b>LUMIÈRE</b> / DESK	<b>p. 410</b>	>
<b>LUMIÈRE</b> / VANITY TABLE	<b>p. 412</b>	>
<b>MARTON</b> / DINING TABLE	<b>p. 326</b>	>
<b>MODULO</b> / BOOKCASE	<b>p. 188</b>	>
<b>MORGAN</b> / DINING TABLE	<b>p. 418</b>	>
<b>MORGAN</b> / LOW COFFEE TABLE	<b>p. 420</b>	>
<b>NARA</b> / BENCH	<b>p. 92</b>	>
<b>NARA</b> / CONSOLE	<b>p. 94</b>	>
<b>NARA</b> / DESK	<b>p. 72</b>	>
<b>NARA</b> / NIGHT TABLE · CHEST OF DRAWERS	<b>p. 76</b>	>
<b>NARA</b> / SHOWCASE WITH DRAWERS	<b>p. 90</b>	>
<b>ORLANDO</b> / DINING TABLE	<b>p. 352</b>	>
<b>ORLANDO</b> / FLOOR LAMP	<b>p. 348</b>	>
<b>ORLANDO</b> / SIDE TABLE	<b>p. 350</b>	>



<b>PETRO</b> / COFFEE TABLE · SIDE TABLE	<b>p. 138</b>	>
<b>PETRO</b> / CONSOLE	<b>p. 148</b>	>
<b>PIGRONE</b> / CLUB CHAIR	<b>p. 466</b>	>
<b>PIGRONE</b> / SOFA	<b>p. 464</b>	>
<b>QUINTO</b> / CHAISE LONGUE	<b>p. 182</b>	>
<b>QUINTO</b> / SOFA · MODULAR SOFA	<b>p. 172</b>	>
<b>RIGO</b> / DINING TABLE	<b>p. 42</b>	>
<b>SINATRA</b> / ARMCHAIR · OTTOMAN	<b>p. 470</b>	>
<b>SOPHIA</b> / DINING ARM CHAIR	<b>p. 472</b>	>
<b>STILBO</b> / NIGHT TABLE · CHEST OF DRAWERS	<b>p. 134</b>	>
<b>TALLO</b> / SIDE TABLE	<b>p. 226</b>	>
<b>THEA</b> / CLUB CHAIR	<b>p. 228</b>	>
<b>THEA SOFT</b> / CLUB CHAIR	<b>p. 230</b>	>
<b>THEO</b> / DINING TABLE	<b>p. 106</b>	>
<b>TIFFANY</b> / CONSOLE	<b>p. 48</b>	>
<b>TISSI</b> / BED	<b>p. 96</b>	>
<b>TISSI</b> / BENCH	<b>p. 116</b>	>
<b>TISSI</b> / LOUNGE CHAIR	<b>p. 110</b>	>
<b>TISSI</b> / CHAIR	<b>p. 108</b>	>

<b>TISSI</b> / SMALL BENCH	<b>p. 114</b>	>
<b>TOMO</b> / DINING TABLE	<b>p. 194</b>	>
<b>TULIPANO</b> / SIDE TABLE	<b>p. 354</b>	>
<b>TUSCANIA</b> / CLUB CHAIR · OTTOMAN	<b>p. 424</b>	>
<b>VIOLA</b> / CLUB CHAIR	<b>p. 184</b>	>
<b>YANG</b> / COFFEE TABLE · SIDE TABLE	<b>p. 224</b>	>
<b>YANG</b> / SHOWCASE	<b>p. 52</b>	>
<b>YANG</b> / WALL UNIT	<b>p. 64</b>	>
<b>YANG</b> / SIDEBOARD	<b>p. 62</b>	>
<b>ZAFFIRO</b> / BED	<b>p. 244</b>	>
<b>ZAFFIRO ALTO</b> / BED	<b>p. 258</b>	>
<b>ZIRCONE</b> / DINING TABLE	<b>p. 240</b>	>

**TECHNICAL FEATURES** >

**FINISHES** >

**UPHOLSTERY** >



DINING TABLES



**CORALLO**

Gallery >

Technical features >



**CORALLO**

Gallery >

Technical features >



**DOLCEVITA**

Gallery >

Technical features >



**HIRO**

Gallery >

Technical features >



**HIRO WO**

Gallery >

Technical features >



**MARTON**

Gallery >

Technical features >



**MORGAN**

Gallery >

Technical features >



**ORLANDO**

Gallery >

Technical features >



**RIGO**

Gallery >

Technical features >



**THEO**

Gallery >

Technical features >



**TOMO**

Gallery >

Technical features >



**ZIRCONE**

Gallery >

Technical features >

CHAIRS



**ADELE**

Gallery >

Technical features >



**BIRKIN**

Gallery >

Technical features >



**COLETTE**

Gallery >

Technical features >



**DILETTA**

Gallery >

Technical features >



**EGLE**

Gallery >

Technical features >



**EGLE**

Gallery >

Technical features >



**EGLE**

Gallery >

Technical features >



**EGLE**

Gallery >

Technical features >



**GEMMA**

Gallery >

Technical features >



**GEMMA**

Gallery >

Technical features >



**GILDA**

Gallery >

Technical features >



**GILDA BI**

Gallery >

Technical features >



CHAIRS



**GILDA COVER**

Gallery >

Technical features >



**GILDA BI COVER**

Gallery >

Technical features >



**LUCY**

Gallery >

Technical features >



**SOPHIA**

Gallery >

Technical features >



**TISSI**

Gallery >

Technical features >

SOFAS



**ANEMONE**

Gallery >

Technical features >



**EDMOND**

Gallery >

Technical features >



**ELIODORO**

Gallery >

Technical features >



**GIORGIO**

Gallery >

Technical features >



**HOLLYWOOD**

Gallery >

Technical features >



**HUGO**

Gallery >

Technical features >



**HUGO**

Gallery >

Technical features >



**HUGO**

Gallery >

Technical features >



**KELLY**

Gallery >

Technical features >





SOFAS



**PIGRONE**

Gallery >

Technical features >



**QUINTO**

Gallery >

Technical features >



**QUINTO**

Gallery >

Technical features >



**QUINTO**

Gallery >

Technical features >

ARMCHAIRS AND OTTOMANS



**ACQUAMARINA**

Gallery >

Technical features >



**AMBRA**

Gallery >

Technical features >



**ANEMONE**

Gallery >

Technical features >



**BRIGITTA**

Gallery >

Technical features >



**CAMELIA**

Gallery >

Technical features >



**DOLCEVITA**

Gallery >

Technical features >



**DOLCEVITA**

Gallery >

Technical features >



**ELIODORO**

Gallery >

Technical features >



**GIORGIO**

Gallery >

Technical features >



**HOLLYWOOD**

Gallery >

Technical features >



**HUGO**

Gallery >

Technical features >



**HUGO**

Gallery >

Technical features >



ARMCHAIRS AND OTTOMANS



**JULIETTE**

Gallery >

Technical features >



**JULIETTE**

Gallery >

Technical features >



**KELLY**

Gallery >

Technical features >



**KUBBU**

Gallery >

Technical features >



**NARA**

Gallery >

Technical features >



**PIGRONE**

Gallery >

Technical features >



**SINATRA**

Gallery >

Technical features >



**SINATRA**

Gallery >

Technical features >



**THEA**

Gallery >

Technical features >



**THEA SOFT**

Gallery >

Technical features >



**TISSI**

Gallery >

Technical features >



**TISSI**

Gallery >

Technical features >

ARMCHAIRS AND OTTOMANS



**TISSI**

Gallery >

Technical features >



**TUSCANIA**

Gallery >

Technical features >



**TUSCANIA**

Gallery >

Technical features >



**VIOLA**

Gallery >

Technical features >



COFFEE AND SIDE TABLES



**AMBRA**

Gallery >

Technical features >



**ANDRÈ**

Gallery >

Technical features >



**ARGO**

Gallery >

Technical features >



**ARGO**

Gallery >

Technical features >



**ARGO**

Gallery >

Technical features >



**CAMELIA**

Gallery >

Technical features >



**CAMELIA**

Gallery >

Technical features >



**CHARLI**

Gallery >

Technical features >



**DOLCEVITA**

Gallery >

Technical features >



**DOLCEVITA**

Gallery >

Technical features >



**DOLCEVITA**

Gallery >

Technical features >



**FERRANDO**

Gallery >

Technical features >

COFFEE AND SIDE TABLES



**FERRANDO**

Gallery >

Technical features >



**JACQUES**

Gallery >

Technical features >



**MORGAN**

Gallery >

Technical features >



**ORLANDO**

Gallery >

Technical features >



**PETRO**

Gallery >

Technical features >



**PETRO**

Gallery >

Technical features >



**TALLO**

Gallery >

Technical features >



**TULIPANO**

Gallery >

Technical features >



**PETRO**

Gallery >

Technical features >



**YANG**

Gallery >

Technical features >



**YANG**

Gallery >

Technical features >



CONSOLES



**FERRANDO**

- Gallery >
- Technical features >



**LIRICA**

- Gallery >
- Technical features >



**LUMIÈRE**

- Gallery >
- Technical features >



**NARA**

- Gallery >
- Technical features >



**PETRO**

- Gallery >
- Technical features >



**TIFFANY**

- Gallery >
- Technical features >

DESKS



**AMBRA**

- Gallery >
- Technical features >



**KOBE**

- Gallery >
- Technical features >



**KOBE**

- Gallery >
- Technical features >



**LUMIÈRE**

- Gallery >
- Technical features >



**LUMIÈRE**

- Gallery >
- Technical features >



**NARA**

- Gallery >
- Technical features >



VANITY TABLES



**AMBRA**

- Gallery >
- Technical features >



**DOLCEVITA**

- Gallery >
- Technical features >



**LUMIÈRE**

- Gallery >
- Technical features >

BOOKCASES



**MODULO**

- Gallery >
- Technical features >



**MODULO**

- Gallery >
- Technical features >



**MODULO**

- Gallery >
- Technical features >



STORAGES



**AMBRA**

- Gallery >
- Technical features >



**AMBRA**

- Gallery >
- Technical features >



**AMBRA**

- Gallery >
- Technical features >



**AMBRA**

- Gallery >
- Technical features >



**AMBRA**

- Gallery >
- Technical features >



**AMBRA**

- Gallery >
- Technical features >



**ASMARA**

- Gallery >
- Technical features >



**ASMARA**

- Gallery >
- Technical features >



**ASMARA**

- Gallery >
- Technical features >

STORAGES



**DOLCEVITA**

- Gallery >
- Technical features >



**DOLCEVITA**

- Gallery >
- Technical features >



**DOLCEVITA**

- Gallery >
- Technical features >



**NARA**

- Gallery >
- Technical features >



**YANG**

- Gallery >
- Technical features >



**YANG**

- Gallery >
- Technical features >



**YANG**

- Gallery >
- Technical features >



NIGHT STORAGES



**AMBRA**  
 Gallery >  
 Technical features >



**AMBRA**  
 Gallery >  
 Technical features >



**AMBRA**  
 Gallery >  
 Technical features >



**AMBRA**  
 Gallery >  
 Technical features >



**AMBRA**  
 Gallery >  
 Technical features >



**ASMARA**  
 Gallery >  
 Technical features >



**ASMARA**  
 Gallery >  
 Technical features >



**ASMARA**  
 Gallery >  
 Technical features >



**DOLCEVITA**  
 Gallery >  
 Technical features >



**DOLCEVITA**  
 Gallery >  
 Technical features >



**NARA**  
 Gallery >  
 Technical features >



**NARA**  
 Gallery >  
 Technical features >

NIGHT STORAGES



**NARA**  
 Gallery >  
 Technical features >



**NARA**  
 Gallery >  
 Technical features >



**NARA**  
 Gallery >  
 Technical features >



**STILBO**  
 Gallery >  
 Technical features >



**STILBO**  
 Gallery >  
 Technical features >



BEDS



**ELLIOT**

- Gallery >
- Technical features >



**ELLIOT DECÒ**

- Gallery >
- Technical features >



**JACOB**

- Gallery >
- Technical features >



**JOLO**

- Gallery >
- Technical features >



**KELLY**

- Gallery >
- Technical features >



**LADONE**

- Gallery >
- Technical features >



**TISSI**

- Gallery >
- Technical features >



**ZAFFIRO**

- Gallery >
- Technical features >



**ZAFFIRO ALTO**

- Gallery >
- Technical features >

COMPLEMENTARY FURNITURE



**ASTRID**

- Gallery >
- Technical features >



**ORLANDO**

- Gallery >
- Technical features >







Galimberti Nino

SIDEBOARD

# ASMARA

— Studio Galimberti • 2016 —



▶  
ASMARA - ASM 84D  
232 x 54 x h.90 cm

Timeless and sophisticated, Asmara collection will add a bright decorative accent and precious storage space to any home. Its minimalist structure is highlighted and embellished by the linear base, that gives it the lightness, and by the solid wood profile, which frames doors and underlines the importance and preciousness of brass handles, giving a charm that has no age to these pieces.

STORAGES >

TECHNICAL FEATURES >











▲   
ASMARA - ASM 82B  
120 x 54 x h.90 cm

Galimberti Nino

DINING TABLE

# RIGO

— Studio Galimberti · 2012 —



RIGO - RIG 82T  
190/open 309 x 100 x h.76 cm

This elegant dining table, stunning in its simplicity, will bring a touch of luxurious sophistication to a classically decorated dining room, thanks to its exquisite craftsmanship and the use of precious material. Celebrating the essence of pure form, this table showcases a minimalistic top where the striking natural veins of the wood are a one-of-a-kind artistic decoration of the piece.

 DINING TABLES >

 TECHNICAL FEATURES >







Galimberti Nino

DINING ARM CHAIR

# DILETTA

— Studio Galimberti • 2020 —



 ▶  
DILETTA - DIL 31B  
59 x 63 x h.90 cm

A surprising series of curves distinguish the elegant and sinuous design of this chair. Around a dining table or behind a classic desk, this piece will give a touch of refined and timeless elegance to both a classic and contemporary interior. The perfectly proportioned wooden base beautifully contrasts with the soft curves that characterize the seat and backrest.

 CHAIRS >

 TECHNICAL FEATURES >



Galimberti Nino

CONSOLE

# TIFFANY

— Studio Galimberti · 1994 —



 TIFFANY - TFY 01E  
90 x 43 x h.87 cm

The Tiffany console is the quintessence of the decorative element that is expressed in conferring an unusual and timeless prestige and dynamism to any interiors, be it classic or contemporary. A romantic idea, a reminiscence of classicism, it expresses in its being the craftsmanship, the mastery of the art of cabinetry and the great attention to the detail of the high-manufactured furniture piece.

 CONSOLES >

 TECHNICAL FEATURES >





Galimberti Nino

SHOWCASE

# YANG

— Ilenia Viscardi · 2020 —



  
YANG - YAN 24D  
92 x 53 x h.171 cm

The delicate shapes of this beautiful piece of furniture with a charming design and unique style will give a refined and timeless elegance to any interior, as modern as classical one. The sophisticated showcase, aerial and sunny, with a slight oriental touch, with the handles that are set like jewels in the structure of the doors, is supported by the base with minimal geometric lines embellished with the delicate sculptural decoration of the legs.

 | STORAGES >

 | TECHNICAL FEATURES >













Galimberti Nino

SIDEBOARD

# YANG

— Ilenia Viscardi · 2020 —



  
YANG - YAN 48L  
240 x 50 x h.90 cm

The delicate shapes of these beautiful pieces of furniture with a charming design and unique style will give a refined and timeless elegance to any interior, as modern as classical one. The sophisticated showcase, aerial and sunny, and the beautiful sideboard with a slight oriental touch, with the handles that are set like jewels in the structure of the doors, are supported by the base with minimal geometric lines embellished with the delicate sculptural decoration of the legs.

 | STORAGES >

 | TECHNICAL FEATURES >



Galimberti Nino

WALL UNIT

# YANG

— Ilenia Viscardi · 2020 —



 ▶  
YANG - YAN 33M  
280 X 40 X H.45 cm

The delicate shapes of these beautiful pieces of furniture with a charming design and unique style will give a refined and timeless elegance to any interior, as modern as classical one. The sophisticated showcase, aerial and sunny, and the beautiful sideboard with a slight oriental touch, with the handles that are set like jewels in the structure of the doors, are supported by the base with minimal geometric lines embellished with the delicate sculptural decoration of the legs.

 | STORAGES >

 | TECHNICAL FEATURES >









Galimberti Nino

DESK

# NARA

— Ilenia Viscardi · 2020 —



 **NARA - NAR 33P**  
150 x 75 x h.75 cm

This splendid desk is part of the Nara collection, unique and unmistakable, with a surprising blend of oriental and western styles. The design that is both simple and sophisticated at the same time, the precious materials used for the creation of this prestigious piece of furniture, will give a timeless elegance to any home, both modern and classic one.

 **DESKS** >

 **TECHNICAL FEATURES** >



Galimberti Nino





Galimberti Nino

NIGHT TABLE · CHEST OF DRAWERS

# NARA

— Ilenia Viscardi · 2020 —



 **NARA - NAR 21N**  
53 x 42 x h.50 cm

Art Dèco style and oriental scents of the old Japanese city Nara, to which the collection dedicates its name, are naturally fused in the design of these refined night storages. This careful blend of stylistic expressions, so different in the timing line and in the geographical provenience gives birth to a collection with a unique and incomparable style. The design with simple and sophisticated lines at the same time, the use of fine materials, the delicate play of contrast in the handles will give timeless sophistication and elegance to any interior.

 | NIGHT STORAGES >

 | TECHNICAL FEATURES >









▲    
NARA - NAR 07G  
140 x 50 x h.82 cm







▲   
NARA - NAR 08H  
140 x 50 x h.65 cm







▲    
NARA - NAR 09L  
53 x 42 x h.136 cm

◀    
NARA - NAR 10M  
60 x 42 x h.65 cm

Galimberti Nino

SHOWCASE WITH DRAWERS

# NARA

— Ilenia Viscardi · 2020 —



 NARA - NAR 93F  
92 x 49 x h.194 cm

Art Déco style and oriental scents of the old Japanese city Nara, to which the collection dedicates its name, are naturally fused in the design of this refined showcase. This careful blend of stylistic expressions, so different in the timing line and in the geographical provenience gives birth to a collection with a unique and incomparable style. The design with simple and sophisticated lines at the same time, the use of fine materials, the delicate play of contrast in the handles will give timeless sophistication and elegance to any interior.

 NIGHT STORAGES >

 TECHNICAL FEATURES >



Galimberti Nino

BENCH  
**NARA**

— Ilenia Viscardi · 2020 —



 **NARA - NAR 67R**  
130 x 40 x h.44 cm

This splendid bench is part of the Nara collection, unique and unmistakable, with a surprising blend of oriental and western styles. The design that is both simple and sophisticated at the same time, the precious materials used for the creation of this prestigious piece of furniture, will give a timeless elegance to any home, both modern and classic one.

 **ARMCHAIRS  
AND OTTOMANS** >

 **TECHNICAL FEATURES** >





Galimberti Nino

CONSOLE

# NARA

— Ilenia Viscardi · 2020 —



  
NARA - NAR 45A  
150 x 40 x h.85 cm

This splendid console is part of the Nara collection, unique and unmistakable, with a surprising blend of oriental and western styles. The design that is both simple and sophisticated at the same time, the precious materials used for the creation of this prestigious piece of furniture, will give a timeless elegance to any home, both modern and classic one.

 CONSOLES >

 TECHNICAL FEATURES >



Galimberti Nino

BED

# TISSI

— Ilenia Viscardi · 2020 —



 ▶  
TISSI - TIS 18B  
235 x 236 x h.102 cm

Sensual, curvy, mischievous. Tissi bed manages to be proactive and audacious thanks to its rounded and inviting shapes. Its important dimensions and its lines that constantly change direction, make it a unique and gritty piece. Tissi bed, while appearing strong and alter, dominates the scene with lightness and elegance. It adapts to every kind of environment, from classic to contemporary.

 BEDS >

 TECHNICAL FEATURES >











Galimberti Nino

DINING TABLE

# THEO

— Studio Galimberti • 2022 —



 THEO - TEO 16R  
Ø160 x h.76 cm

Theo dining table will stand out with its elegant and soft lines both in a modern and contemporary environment, where it will be an important presence thanks to the harmonious combination of the linearity of the top with the expressive solidity of the bases.

 DINING TABLE >

 TECHNICAL FEATURES >



Galimberti Nino

DINING CHAIR

**TISSI**

— Studio Galimberti · 2019 —



 ▶  
TISSI - TIS 41D  
59 x 62 x h.74 cm

Tissi chair is an elegant and comfortable piece distinctive for its soft rounded silhouette that seems to float in midair supported by four thin legs decorated with brass ferrules. This item will be decorative and functional for any kind of environment, as around a dining table, as in front of a desk.

 CHAIRS >

 TECHNICAL FEATURES >





Galimberti Nino

LOUNGE CHAIR

# TISSI

— Studio Galimberti · 2019 —



 ▶  
TISSI - TIS 55A  
59 x 62 x h.70 cm

Tissi lounge chair and benches are elegant and comfortable pieces, distinctive for their soft rounded silhouette that seem to float in midair supported by four thin legs decorated with brass ferrules. These items will be decorative and functional for any kind of environment, in the bedroom, entrance hall or living room.

 | **ARMCHAIRS  
AND OTTOMANS** >

 | **TECHNICAL FEATURES** >





Galimberti Nino

SMALL BENCH

**TISSI**

— Studio Galimberti • 2019 —



 ▶  
TISSI - TIS 73C  
64 x 46 x h.41 cm

Tissi lounge chair and benches are elegant and comfortable pieces, distinctive for their soft rounded silhouette that seem to float in midair supported by four thin legs decorated with brass ferrules. These items will be decorative and functional for any kind of environment, in the bedroom, entrance hall or living room.

 | **ARMCHAIRS  
AND OTTOMANS** >

 | **TECHNICAL FEATURES** >



Galimberti Nino

BENCH

# TISSI

— Studio Galimberti • 2019 —



 TISSI - TIS 62B  
136 x 43 x h.43 cm

Tissi lounge chair and benches are elegant and comfortable pieces, distinctive for their soft rounded silhouette that seem to float in midair supported by four thin legs decorated with brass ferrules. These items will be decorative and functional for any kind of environment, in the bedroom, entrance hall or living room.

 [ARMCHAIRS AND OTTOMANS](#) >

 [TECHNICAL FEATURES](#) >



Galimberti Nino

COFFEE TABLE

# JACQUES

— Studio Galimberti • 2018 —



  
JACQUES - JCQ 63B  
Ø130 x h.33 cm

The charming cut-out silhouette of this coffee table gives it a light and airy look, making it a statement piece in a contemporary or modern interior. Metal inserts add a surprising textural contrast with the round upper and lower tops, for a refined final effect.

 COFFEE AND  
SIDE TABLES >

 TECHNICAL FEATURES >



Galimberti Nino

SOFA • SOFA BED

# GIORGIO

— Studio Galimberti • 2020 —



 ▶  
GIORGIO - GIO 24D  
240 x 100 x h.80 cm

The tradition of shapes and proportions is expressed with sublime elegance in Giorgio sofas revealing itself decisively in the fine worked quilts of the backrest and armrests. This beautiful collection of the upholstered furniture will infuse a timeless charm in every ambience of the house, both classic and contemporary, and it will be noticed and appreciated as a presence of pure class even in an absolutely modern location.

 SOFAS >

 TECHNICAL FEATURES >





Galimberti Nino

CLUB CHAIR

# GIORGIO

— Studio Galimberti • 2020 —



GIORGIO - GIO 40A  
114 x 100 x h.80 cm

The tradition of shapes and proportions is expressed with sublime elegance in Giorgio club chair revealing itself decisively in the fine worked quilts of the backrest and armrests. This beautiful collection of the upholstered furniture will infuse a timeless charm in every ambience of the house, both classic and contemporary, and it will be noticed and appreciated as a presence of pure class even in an absolutely modern location.

ARMCHAIRS  
AND OTTOMANS >

TECHNICAL FEATURES >





Galimberti Nino

CONSOLE

# LIRICA

— Filippo Mambretti · 2012 —



  
LIRICA - LIR 63B  
114 x 41 x h.89 cm

Sophisticated shapes of the Lirica console evoke the style of the 1950s revisited in the contemporary key. Its soft but elegant lines reflect the perfect harmony between style and functionality allowing this piece to express a strong decorative impact in any environment.

 CONSOLES >

 TECHNICAL FEATURES >



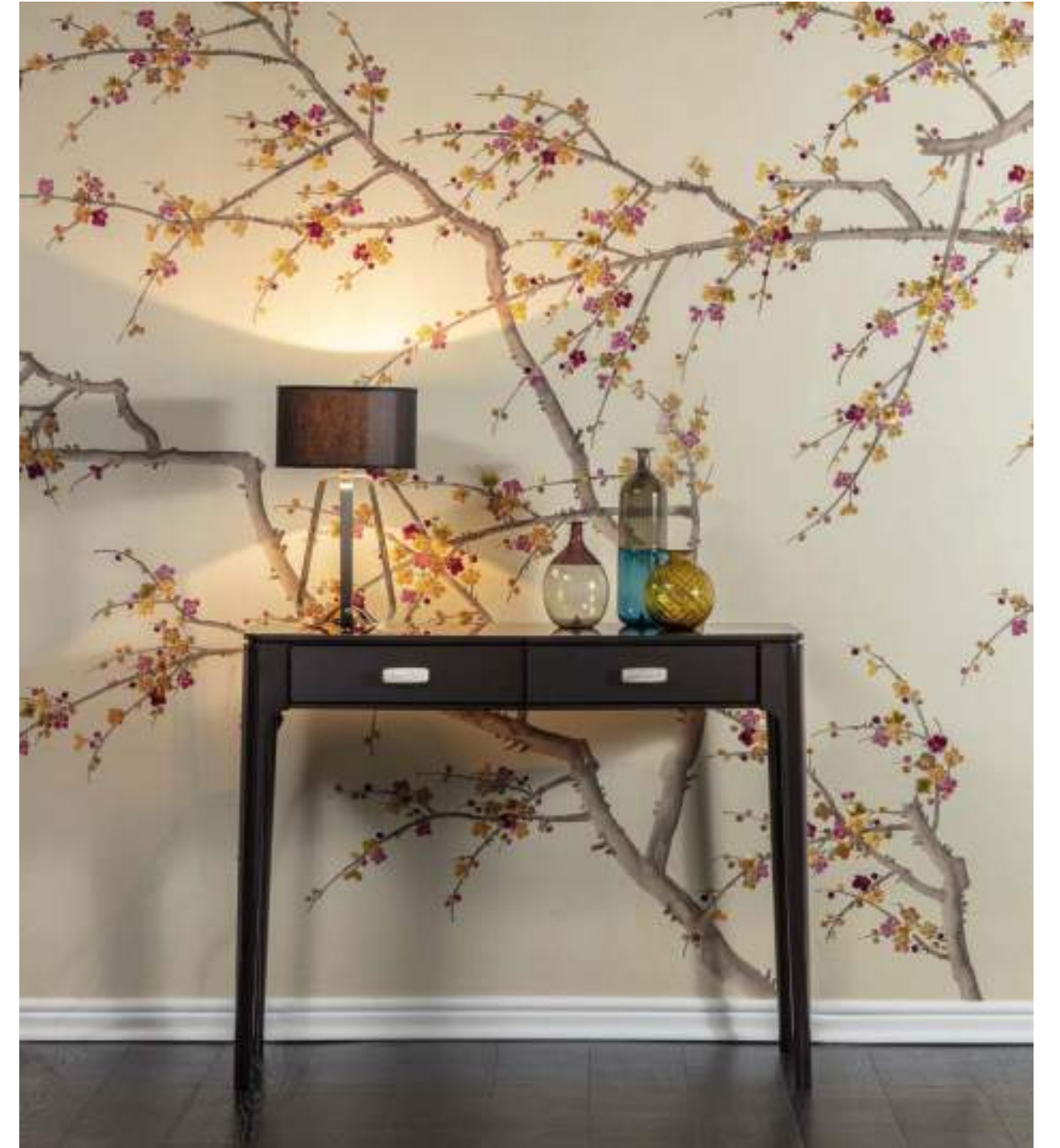

Galimberti Nino

BED

# LADONE

— Studio Galimberti · 2019 —



LADONE - LAD 21P  
194 x 222 x h.115 cm

The Ladone bed is timeless and sophisticated, boasting a classic silhouette and a modern chromatic combination to highlight the multiple shades of colour. The unique design integrates a comfortable curved headboard and a shaped footboard, intriguingly upholstered.

 BEDS >

 TECHNICAL FEATURES >





Galimberti Nino

NIGHT TABLE · CHEST OF DRAWERS

# STILBO

— Studio Galimberti · 2019 —



 ▶  
STILBO - STI 31A  
120 x 51 x h.87 cm

The simple lines, the minimal aesthetic and functional design enriched with unique and refined details define these exquisite night storages that will adorn any bedroom with their clean sophistication. Evoking the elegance of classic 1960s furniture this simple yet chic design will elevate the style of any interior.

 | NIGHT STORAGES >

 | TECHNICAL FEATURES >





▲    
STILBO - STI 42B  
56 x 42 x h.56 cm

Galimberti Nino

COFFEE TABLE • SIDE TABLE

# PETRO

— Studio Galimberti • 2020 —



 PETRO - PET 35H  
120 x 120 x h.40 cm

Proportions and linear shapes of these refined coffee and side tables make them perfectly suitable for any living room, providing a high sense of style while maintaining a delicate and timeless design. A decidedly balanced appearance characterized by precious details infuses refinement and elegance in both a classic and contemporary interior.

 COFFEE AND  
SIDE TABLES >

 TECHNICAL FEATURES >









▲    
PETRO - PET 34F  
180 x 100 x h.40 cm





▲  PETRO - PET 37M  
50 x 50 x h.56 cm





Galimberti Nino

CONSOLE

# PETRO

— Studio Galimberti • 2020 —

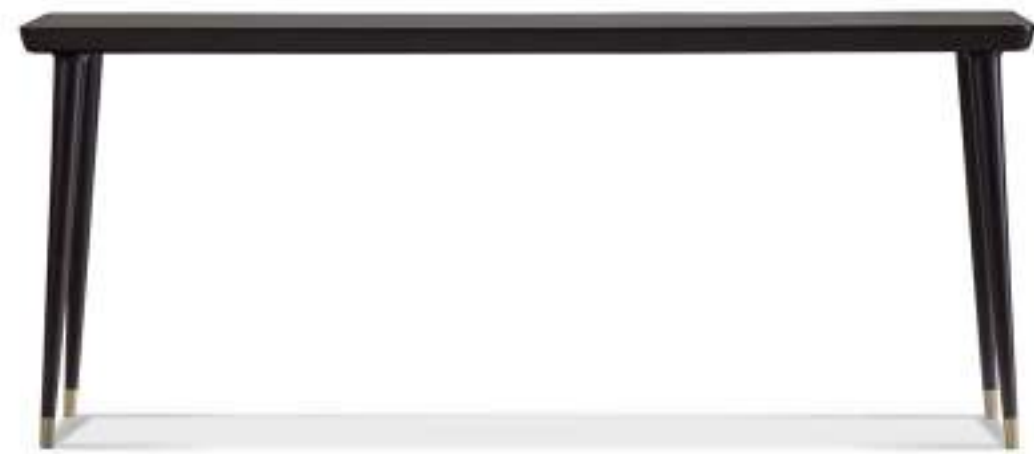

 PETRO - PET 40P  
180 x 45 x h.75 cm

Proportions and linear shapes of these refined consoles make them perfectly suitable for any living room, providing a high sense of style while maintaining a delicate and timeless design. A decidedly balanced appearance characterized by precious details infuses refinement and elegance in both a classic and contemporary interior.

 CONSOLES >

 TECHNICAL FEATURES >





▲    
PETRO - PET 41S  
180 x 45 x h.56 cm



▲  PETRO - PET 42T  
180 x 45 x h.40 cm





Galimberti Nino

DESK

# KOBE

— Studio Galimberti · 2018 —



 ▶  
KOBE - KOB 02B  
150 x 50 x h.73 cm

Strict by symmetrical and regular lines Kobe desk represents order and rationality. The metal inserts create the frame for the wooden elements that compose the item. It generates essential shapes that are capable to host decorative details, such as handles and leather pocket with embossed stitching, which make it charming and unique.

 DESKS >

 TECHNICAL FEATURES >







▲   
KOBÉ - KOB 04D  
170 x 75 x h.73 cm



Galimberti Nino

CLUB CHAIR

# JULIETTE

— Studio Galimberti · 2011 —



JULIETTE - JUL 01A  
85 x 89 x h.69 cm

Elegance and comfort blend with the contemporary, curved, soft and essential lines of the Juliette club chair and ottoman, giving the origin to a perfectly balanced design full of harmony. Its timeless charm and inviting padded structure are highlighted by the linear base in solid wood, minimalist but at the same time characterized by a impressive and surprising visual impact.

 | **ARMCHAIRS  
AND OTTOMANS** >

 | **TECHNICAL FEATURES** >



Nuovo Classico Milanese



Galimberti Nino

SMALL OTTOMAN

# JULIETTE

— Studio Galimberti · 2011 —



JULIETTE - JUL 36F  
40 x 40 x h.42 cm

Elegance and comfort blend with the contemporary, curved, soft and essential lines of the Juliette club chair and ottoman, giving the origin to a perfectly balanced design full of harmony. Its timeless charm and inviting padded structure are highlighted by the linear base in solid wood, minimalist but at the same time characterized by a impressive and surprising visual impact.

 | **ARMCHAIRS  
AND OTTOMANS** >

 | **TECHNICAL FEATURES** >

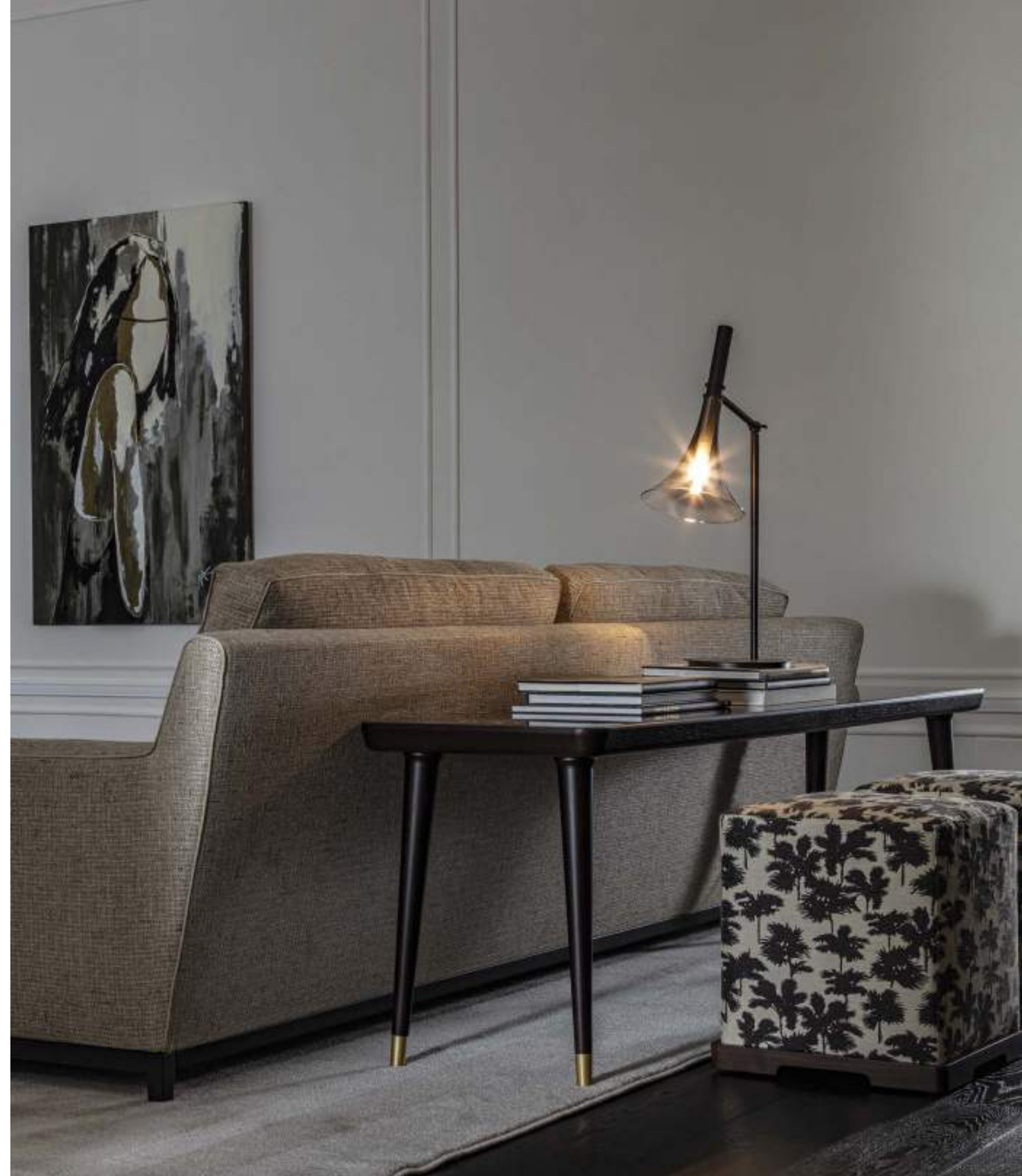

Galimberti Nino

SIDE TABLE

# CHARLI

— Studio Galimberti • 2010 —



 CHARLI - CHA 26B  
Ø74 x h.51 cm

The unique and refined silhouette of Charli coffee table make it the expression of the craftsmanship essence. Three minimalist legs, enriched by sumptuous brass ferrules, sustain a wonderful corolla and a thin glass top, whose transparency opens the vision of the wonderful support construction. In an entryway, living room or bedroom, its presence will be a touch of unique and inimitable style.

 COFFEE AND  
SIDE TABLES >

 TECHNICAL FEATURES >







Galimberti Nino

SOFA • MODULAR SOFA

# QUINTO

— Studio Galimberti • 2019 —



 ▶  
QUINTO - QUN C11  
268 x 192 x h.80 cm

A rigorous and clean shape with a square appearance softened by the cozy cushions, the Quinto sofas and modular sofas recall the clean and minimal lines of Nordic design. A clear and sincere piece in its simplicity but characterized by a timeless style that will fill with charm any environment where it's placed.

 SOFAS >

 TECHNICAL FEATURES >









▲   
QUINTO - QUN 31B  
268 x 96 x h.80 cm







Galimberti Nino

CHAISE LONGUE

# QUINTO

— Studio Galimberti • 2019 —



 ▶  
QUINTO - QUN 42D  
192 x 96 x h.80 cm

A rigorous and clean shape with a square appearance softened by the cozy cushions, the Quinto chaises longues recall the clean and minimal lines of Nordic design. A clear and sincere piece in its simplicity but characterized by a timeless style that will fill with charm any environment where it's placed.

 | SOFAS >

 | TECHNICAL FEATURES >



Galimberti Nino

CLUB CHAIR

# VIOLA

— Ilenia Viscardi · 2020 —



 **VIOLA - VIO 72K**  
110 x 75 x h.80 cm

A club chair with innovative and audacious lines and surprising textile workmanship, with its sculptural structure, iconic shape and comfortable and wide seat that manages to fill with charm and fantasy the scenery of the environment in which it may express its innate grit and undeniable versatility.

 **ARMCHAIRS  
AND OTTOMANS** >

 **TECHNICAL FEATURES** >





Galimberti Nino

BOOKCASE

# MODULO

— Studio Galimberti • 2007 —



 **MODULO - MOD 201**  
175 x 43 x h.50 cm

A library with a rigorous and light character, which allows it to fit harmoniously into any environment, Modulo is simply "The Library". A wonderful piece of decoration characterized by a pure and essential line, by a studied simplicity of the design and a choice of sophisticated materials and refined details that allow it to play a leading role within the living space, thanks to the variety of proposed finishes, which give it a strong decorative charm of contemporary taste.

 **BOOKCASES** >

 **TECHNICAL FEATURES** >







MODULO - MOD 202  
175 x 43 x h.92 cm





▲   
MODULO - MOD 206  
175 x 43 x h.264 cm



Galimberti Nino

DINING TABLE

# TOMO

— Ilenia Viscardi · 2020 —



  
TOMO - TOM 32C  
300 x 110 x h.75 cm

The sculptural shapes combined with the light and aerial appearance give the unique perfection of the proportions to the Tomo table despite its decidedly important dimensions. A personality that is not limited to any style allows it to be combined with every type of chair, from the most classic to the most modern. Its nature does not allow to be locked up in any stylistic category except the one called work of art.

 | DINING TABLES >

 | TECHNICAL FEATURES >











Galimberti Nino

DINING CHAIR

# EGLE

— Studio Galimberti • 2020 —



 ▶  
EGLE - EGL 14B  
51 x 54 x h.82 cm

The perfection of Egle chair and bar stool proportions is reflected in the successful combination of the back with its delicate and sinuous curves, expression of a soft embrace, with the base in precious solid wood in which the smoothness of the finish beautifully contrasts with the bright and luxurious presence of brass details. A unique piece with a personality strong enough to impress its character in any environment, both classic and modern.

 CHAIRS >

 TECHNICAL FEATURES >







Galimberti Nino

DINING ARM CHAIR

# ADELE

— Studio Galimberti • 2017 —



 ▶  
ADELE - ADE 22B  
57 x 63 x h.83 cm

The Adele arm chair summarises the essence of contemporary design and the memory of tradition. Subtle elegance and timeless allure distinguish the elegant design of this versatile piece of functional decor that will make a statement in any interior, either by a dining table, behind a desk or in an entryway.

 CHAIRS >

 TECHNICAL FEATURES >







Galimberti Nino

DINING TABLE

# HIRO

— Ilenia Viscardi · 2019 —



 HIRO - HIR 21N  
210 x 101 x h.75 cm

Celebrating the essence of pure form, suitable for modern and classic decors, the contrasting textures of marble top and wooden legs confer sophistication and character to the piece. A stunning combination of natural materials and fine craftsmanship, this dining table redefines interiors with its sleek silhouette and architectural presence.

 DINING TABLES >

 TECHNICAL FEATURES >





Galimberti Nino

DINING CHAIR

# COLETTE

— Studio Galimberti • 2019 —



 ▶  
COLETTE - COL 23B  
47 x 51 x h.82 cm

The Colette chair simple yet elegant, made of linear pieces that boast exquisite craftsmanship and fine materials. Its gentle curves envelop the body in a comfortable hug. A perfect chair for a contemporary decor, this piece will add a note of sophistication to any dining or living room.

 CHAIRS >

 TECHNICAL FEATURES >



Galimberti Nino

DINING CHAIR

# BIRKIN

— Studio Galimberti · 2004 —



 **BIRKIN - BIR 33B**  
48 x 51 x h.86 cm

Leather and a sophisticated design combine in this exquisite chair that will be an ideal companion for a dining table in a loft or for a writing desk in a modern office. The structure in metal boasts sculptural details that create a rigorous frame for the seat and backrest.

 CHAIRS >

 TECHNICAL FEATURES >





Galimberti Nino

SIDE TABLE

# ANDRÈ

— Studio Galimberti • 2018 —



 ANDRÈ - AND 51B  
Ø50 x h.54 cm

A stunning piece of functional decor that boasts a sculptural silhouette and exquisite craftsmanship, this side table is versatile and elegant and can be displayed in any room in the house. Its dynamic silhouette is crafted of wood with a walnut veneer. Its curved legs are adorned with metal inserts.

 COFFEE AND  
SIDE TABLES >

 TECHNICAL FEATURES >



Galimberti Nino

COFFEE TABLE • SIDE TABLE

# YANG

— Studio Galimberti • 2018 —



▲  
YANG - YAN 03C  
141 x 71 x h.40 cm

▲  
YANG - YAN 01A  
51 x 51 x h.50 cm  
YANG - YAN 02B  
61 x 61 x h.70 cm

These stunning coffee and side tables will be a versatile addition to a modern home. Their geometric structure is made of walnut with a delicate sculptural decoration at the bottom of each of four legs. The top is in marble, whose natural veins will add a luxurious accent and a refined allure to any room in the house. These pieces are part of the Yang collection and can be combined with the others in the same series for a dynamic and sophisticated decoration.

COFFEE AND  
SIDE TABLES >

TECHNICAL FEATURES >



Galimberti Nino

SIDE TABLE

# TALLO

— Studio Galimberti · 2019 —



 **TALLO - TAL 01A**  
50 x 45 x h.51 cm

Striking and unique, the playful design of this side table is also its very functional aspect, which allows it to come close to a bed, sofa or armchair becoming a perfect companion for relaxing times spent reading a book or lounging with a drink.

 **COFFEE AND SIDE TABLES** >

 **TECHNICAL FEATURES** >



Galimberti Nino

CLUB CHAIR

# THEA

— Ilenia Viscardi · 2004 —



 THEA - THE 31C  
72 x 71 x h.72 cm

A versatile seating option that is modern and sophisticated, this club chair exudes industrial allure and will be a stunning addition to a modern living room, study or bedroom. Its sinuous structure in metal supports a seat and back covered in leather with visible stitches for a striking contrast.

 **ARMCHAIRS  
AND OTTOMANS** >

 **TECHNICAL FEATURES** >



Galimberti Nino

CLUB CHAIR

# THEA SOFT

— Ilenia Viscardi · 2004 —



THEA SOFT - THE 32D  
72 x 71 x h.72 cm

A versatile seating option that is modern and sophisticated, this club chair exudes industrial allure and will be a stunning addition to a modern living room, study or bedroom. Its sinuous structure in metal supports a seat and back covered in leather with visible stitches for a striking contrast.

ARMCHAIRS  
AND OTTOMANS >

TECHNICAL FEATURES >



Galimberti Nino

CHAIR

# LUCY

— Studio Galimberti · 2018 —



 **LUCY - LCY 22E**  
48 x 45 x h.55 cm

This stunning chair will be a precious seating option around a dining table, in an entryway or behind a desk, and it will add a sculptural decoration that will not pass unnoticed. Its soft pluffy seat contrasts with the rigorous geometry of the unique silhouette with its minimal lines.

 CHAIRS >

 TECHNICAL FEATURES >



Galimberti Nino

NIGHT TABLE · LOUNGE TABLE

# ARGO

— Studio Galimberti · 2019 —



  
ARGO - ARG 07S  
48 x 48 x h.56 cm

A unique and sophisticated accent to a classic or contemporary interior, these night and lounge tables will imbue with brilliance a bedroom, also creating a functional space to store books or everyday objects. Their striking contrast between the warm wooden top and the sculptural base creates a look that is both classic and innovative.

 COFFEE AND  
SIDE TABLES >

 TECHNICAL FEATURES >





ARGO - ARG 23A  
Ø90 x h.63 cm







▲   
ARGO - ARG 11D  
60 x 60 x h.62 cm

Galimberti Nino

DINING TABLE

# ZIRCONE

— Studio Galimberti • 2018 —



ZIRCONE - ZIR 32B  
210/open 330 x 110 x h.78 cm

Extraordinarily versatile design of Zircon table allows it to be placed in any dining room, both classic and contemporary. This elegant table with a soft oval shape is decorated with metal ferrules to complete the fascinating legs with a unique and sophisticated touch.

 | DINING TABLES >

 | TECHNICAL FEATURES >





Galimberti Nino

BED

# ZAFFIRO

— Studio Galimberti · 2014 —



 ▶  
ZAFFIRO - ZAF 01A  
197 x 220 x h.123 cm

Bed with a refined and timeless design, Zaffiro stands out for being an extremely versatile piece which presence will impose itself in every bedroom, both classic and contemporary. It's rich in precious ornamental details and with structural characteristics such as the vertical profiles of the headboard, the soft curves and the feet covered in metal, you will not be able to resist to its unsurpassed charm.

 BEDS >

 TECHNICAL FEATURES >









▲   
ZAFFIRO - ZAF 01A  
177 x 220 x h.123 cm









Galimberti Nino

BED

# ZAFFIRO ALTO

— Studio Galimberti · 2014 —



 ▶  
ZAFFIRO ALTO - ZAH 11A  
197 x 220 x h.172 cm

Bed with a refined and timeless design, Zaffiro Alto stands out for being an extremely versatile piece which presence will impose itself in every bedroom, both classic and contemporary. It's rich in precious ornamental details and with structural characteristics such as the vertical profiles of the headboard, the soft curves and the feet covered in metal, you will not be able to resist to its unsurpassed charm.

 BEDS >

 TECHNICAL FEATURES >







STORAGES

# AMBRA

— Studio Galimberti • 2014 —



AMBRA - AMB 35E  
122 x 50 x h.210 cm

This elegant series of storages is part of the Ambra collection, precious and timeless pieces that can be displayed alone or combined with the other items in the same series and will be the versatile addition to any classic or contemporary home. The linear silhouette of the wooden structure is highlighted and adorned with the luxurious insert in brass, the precious material that is used for the feet ferrules and the round handles as well to add the glamorous look to these items. The drawers bottom is covered with the ecological leather for the further classy touch.

STORAGES >

TECHNICAL FEATURES >







▲    
AMBRA - AMB 47B  
240 x 50 x h.210 cm







▲   
AMBRA - AMB 37G  
122 x 55 x h.96 cm



▲  AMBRA - AMB 38H  
178 x 55 x h.96 cm





▲    
AMBRA - AMB 40M  
122 x 55 x h.151 cm



▲    
AMBRA - AMB 39L  
178 x 45 x h.71 cm



Galimberti Nino

COFFEE TABLE

# AMBRA

— Studio Galimberti • 2014 —



 AMBRA - AMB 32B  
140 x 80 x h.41 cm

This stunning coffee table is an exquisite statement piece for either a modern or a classic living room. The linear silhouette of the wooden structure is underlined and decorated with the luxurious insert in brass, the precious material that is used for the feet ferrules as well to add the glamorous look to this item.

 COFFEE AND SIDE TABLES >

 TECHNICAL FEATURES >



Galimberti Nino

NIGHT TABLE · CHEST OF DRAWERS

# AMBRA

— Studio Galimberti · 2014 —



 ▶  
AMBRA - AMB 41N  
122 x 55 x h.96 cm

This elegant series of night tables and chests of drawers is part of the Ambra collection, precious and timeless pieces that can be displayed alone or combined with the other items in the same series and will be the versatile addition to any classic or contemporary home. The linear silhouette of the wooden structure is highlighted and adorned with the luxurious insert in brass, the precious material that is used for the feet ferrules and the round handles as well to add the glamorous look to these items. The drawers bottom is covered with the ecological leather for the further classy touch.

 | NIGHT STORAGES >

 | TECHNICAL FEATURES >





▲    
AMBRA - AMB 44R  
56 x 45 x h.53 cm



▲  AMBRA - AMB 45S  
70 x 45 x h.65 cm







▲    
AMBRA - AMB 43Q  
160 x 55 x h.96 cm





▲    
AMBRA - AMB 42P  
122 x 50 x h.71 cm

Galimberti Nino

BENCH

# AMBRA

— Studio Galimberti • 2014 —



 ▶  
AMBRA - AMB 31A  
120 x 45 x h.46 cm

This stunning bench is an exquisite statement piece for either a modern or a classic bedroom or entrance hall. Part of the Ambra collection, it can be combined with the others in the same series. The glamorous looking wooden structure has the perimeter brass inserts and four tapered legs adorned with feet in brass.

 | [ARMCHAIRS AND OTTOMANS](#) >

 | [TECHNICAL FEATURES](#) >



Galimberti Nino

VANITY TABLE

# AMBRA

— Studio Galimberti • 2014 —



  
AMBRA - AMB 34D  
111 x 55 x h.78 cm

The vanity table of the Ambra collection is a precious piece of furniture that boast a retrochic allure and exquisite details, it will decorate any ambience with its refined elegance. The linear silhouette of the wooden structure is underlined and decorated with the luxurious insert in brass, the precious material that is used for the feet ferrules and the handles as well to add the glamorous look to this item. The drawers bottom is covered with the ecological leather for the further classy touch.

 | VANITY TABLES >

 | TECHNICAL FEATURES >





Galimberti Nino

DESK

# AMBRA

— Studio Galimberti · 2014 —



AMBRA - AMB 33C  
140 x 70 x h.77 cm

The writing desk of the Ambra collection is a precious piece of furniture that boast a retrochic allure and exquisite details, it will decorate any ambience with its refined elegance. The linear silhouette of the wooden structure is underlined and decorated with the luxurious insert in brass, the precious material that is used for the feet ferrules and the handles as well to add the glamorous look to this item. The drawers bottom is covered with the ecological leather for the further classy touch.

 DESKS >

 TECHNICAL FEATURES >



Galimberti Nino

SOFA

# ELIODORO

— Studio Galimberti • 2014 —



 ▶  
ELIODORO - ELI 61A  
260 x 110 x h.95 cm

This charming sofa, inspired by the elegance of the Art Deco style, stands out with its vibrant classic shape in every ambience of the house. The curved backrest wraps around the seat and flows into the sloping armrests, creating a soft and inviting look, both timeless and comfortable. The metal-covered base adds a touch of luxury, light but significant, making this piece a refined addition to any interior, be it contemporary or traditional.

 SOFAS >

 TECHNICAL FEATURES >







Galimberti Nino

ARMCHAIR

# ELIODORO

— Studio Galimberti • 2014 —



ELIODORO - ELI 62B  
120 x 105 x h.92 cm

This charming armchair, inspired by the elegance of the Art Deco style, stands out with its vibrant classic shape in every ambience of the house. The curved backrest wraps around the seat and flows into the sloping armrests, creating a soft and inviting look, both timeless and comfortable. The metal-covered base adds a touch of luxury, light but significant, making this piece a refined addition to any interior, be it contemporary or traditional.

 | **ARMCHAIRS  
AND OTTOMANS** >

 | **TECHNICAL FEATURES** >



Galimberti Nino

CLUB CHAIR

# ACQUAMARINA

— Studio Galimberti • 2014 —



 **ACQUAMARINA - ACQ 02B**  
78 x 90 x h.72 cm

Elegance and comfort mix in a harmonious design that adds a refined touch to both a modern and a classic interior. Either in a hall or living room, as in the study or as an extra seat in the bedroom, Acquamarina club chair will be functional and decorative. The solid wood profile of the armrests gives a pleasant feeling of winding.

 **ARMCHAIRS  
AND OTTOMANS** >

 **TECHNICAL FEATURES** >





Galimberti Nino

SOFA

# ANEMONE

— Studio Galimberti · 2015 —



 ANEMONE - ANE 11A  
294 x 130 x h.95 cm

The Anemone sofa will express its superb elegance in any modern or classic ambience, thanks to its precious presence and its great comfort. The unique and sinuous shape of its structure, precious covered, has rounded and soft corners, and it's enriched by the fascinating fringe decoration that adds a surprising sense of movement under the seat.

 SOFAS >

 TECHNICAL FEATURES >



Galimberti Nino

OTTOMAN

# ANEMONE

— Studio Galimberti • 2015 —



ANEMONE - ANE 12B  
170 x 80 x h.45 cm

The Anemone ottoman will express its superb elegance in any modern or classic ambience, thanks to its precious presence and its great comfort. The unique and sinuous shape of its structure, preciously covered, has rounded and soft corners, and it's enriched by the fascinating fringe decoration that adds a surprising sense of movement under the seat.

ARMCHAIRS  
AND OTTOMANS >

TECHNICAL FEATURES >



Galimberti Nino

ARMCHAIR

# CAMELIA

— Studio Galimberti • 2015 —



 CAMELIA - CAM 01A  
78 x 80 x h.77 cm

This comfortable elegant armchair boasts a timeless design that will be equally stunning in a classic or contemporary home. It combines slender legs in brass with an enveloping and sinuous silhouette that includes a generous and cozy seat.

 **ARMCHAIRS  
AND OTTOMANS** >

 **TECHNICAL FEATURES** >









Galimberti Nino

COFFEE TABLE

# CAMELIA

— Studio Galimberti • 2015 —



  
CAMELIA - CAM 02B  
150 x 140 x h.23 cm

These sleek and sophisticated coffee tables are a refined choice for a modern or contemporary interior, where their timeless color combination and complementing finishes will create a harmonious effect.

 | COFFEE AND  
SIDE TABLES >

 | TECHNICAL FEATURES >





CAMELIA - CAM 03C  
Ø80 x h.23 cm



Galimberti Nino

DINING TABLE

# CORALLO

— Studio Galimberti • 2014 —



 CORALLO - COR 61A  
400 x 120 x h.76 cm

The Corallo tables stand out for the surprising curved silhouette of the legs, reminiscent of the tulip flower shape, and for the presence of the precious metal details that create a delicate contrast of color and material. These tables are a wonderful addition to a modern or classic home, where they will be of strong visual impact both as a decorative piece in an entrance hall and as a dining table.

 DINING TABLES >

 TECHNICAL FEATURES >





▲   
CORALLO - COR 62B  
Ø130 x h.76 cm

Galimberti Nino

DINING TABLE

# MARTON

— Studio Galimberti • 2021 —



MARTON - MAR 28N  
280 x 110 x h.75 cm

The architectural shape, massive and functional but at the same time refined and sophisticated, the elegant combination of materials and finishes and the fine craftsmanship of the Marton table will put it at the center of attention in any environment. Marton will be able to express the prevalence of pure form over decoration with its harmonious and natural presence.

 | DINING TABLES >

 | TECHNICAL FEATURES >



Galimberti Nino

COFFEE TABLE · SIDE TABLE

# FERRANDO

— Studio Galimberti · 2012 —



  
FERRANDO - FER 01A  
120 x 80 x h.43 cm

With their linear but soft shapes, these beautiful coffee and side tables will be a refined touch for a living area, giving an elegant tone to the house. The satin brass of their sinuous base and thin legs, raises and highlights the brass frame, which welcomes and protects the top in precious natural marble. The charming appearance of these pieces will donate a sophisticated elegance and timeless style to any environment.

 | COFFEE AND  
SIDE TABLES >

 | TECHNICAL FEATURES >







▲   
FERRANDO - FER 02B  
Ø70 x h.70 cm



Galimberti Nino

CONSOLE

# FERRANDO

— Studio Galimberti • 2012 —



  
FERRANDO - FER 03C  
120 x 35 x h.86 cm

With its linear but soft shapes, this beautiful console will be a refined touch for an entrance hall, giving an elegant tone to the house. The satin brass of its sinuous base and thin legs, raise and highlight the brass frame, which welcomes and protects the top in precious natural marble. The charming appearance of this piece will donate a sophisticated elegance and timeless style to any environment.

 CONSOLES >

 TECHNICAL FEATURES >

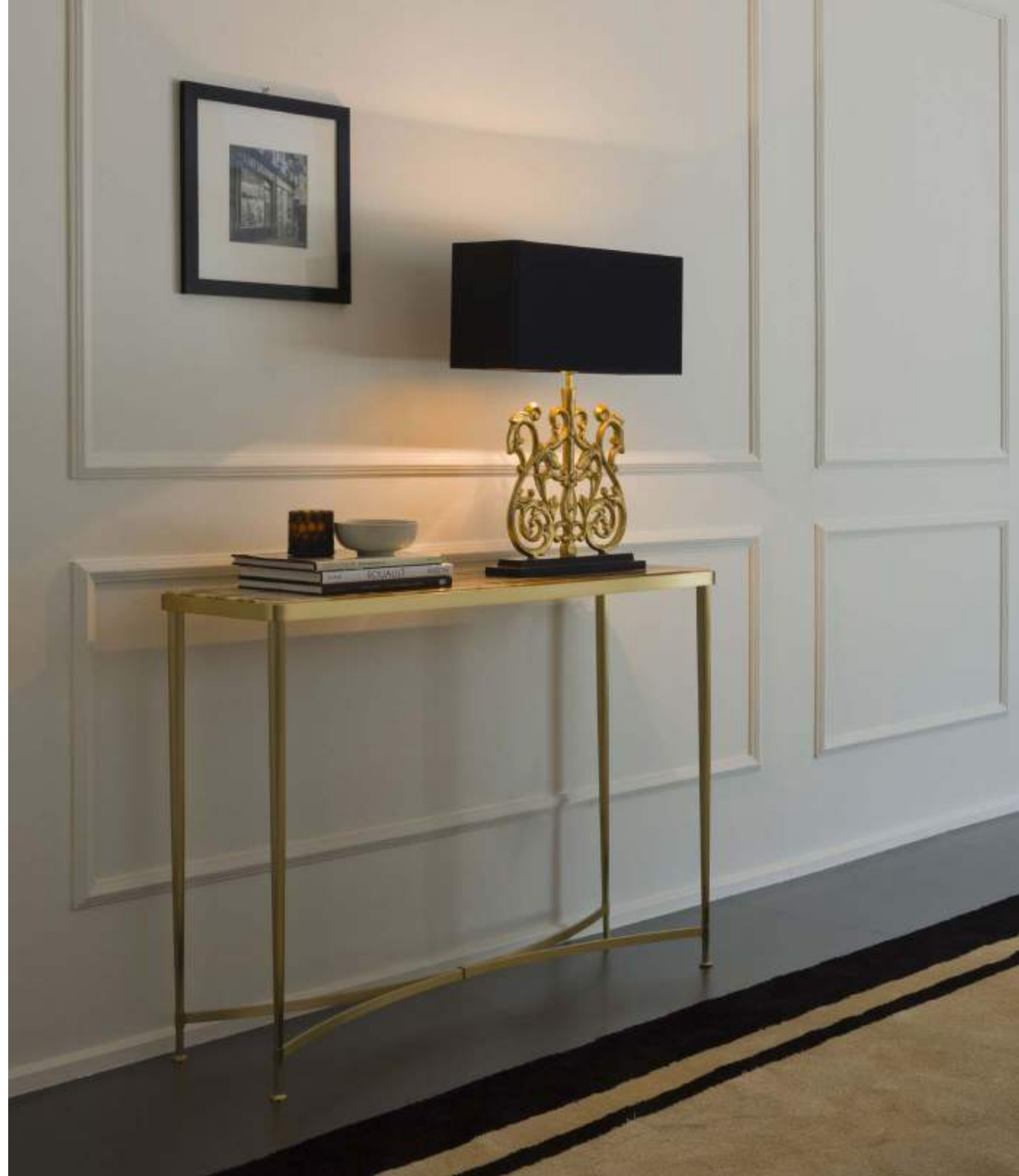

Galimberti Nino

DINING CHAIR · DINING ARM CHAIR  
**GEMMA**  
— Studio Galimberti · 2014 —



 ▶  
GEMMA - GEM 21A  
61 x 60 x h.91 cm

A superb addition to a modern or classic home, this chair is versatile and elegant and it will best express itself both around an important dining table, in a study or in the entrance area. Its wooden structure with rigorous and fluid shapes, highlights its exquisite craftsmanship.

 CHAIRS >

 TECHNICAL FEATURES >





▲   
GEMMA - GEM 22B  
61 x 60 x h.91 cm

Galimberti Nino

DINING CHAIR

# GILDA

— Studio Galimberti · 2009 —



 ▶  
GILDA - GIL 41A  
52 x 56 x h.92 cm

This exquisite chair combines a sinuous silhouette with comfortable seating experience. Either behind a desk in a study, as an accent piece in an entryway or around a dining table, this chair will be a precious addition to both modern and classic homes.

 CHAIRS >

 TECHNICAL FEATURES >





▲  GILDA BI - GIB 91A  
52 x 56 x h.92 cm



Galimberti Nino

DINING CHAIR

# GILDA COVER

— Studio Galimberti • 2009 —



GILDA COVER - GIL 42B  
52 x 56 x h.92 cm

This exquisite chair combines a sinuous silhouette with comfortable seating experience. Either behind a desk in a study, as an accent piece in an entryway or around a dining table, this chair will be a precious addition to both modern and classic homes.

 CHAIRS >

 TECHNICAL FEATURES >





▲  GILDA BI COVER - GIB 92B  
52 x 56 x h.92 cm

Galimberti Nino

FLOOR LAMP

# ORLANDO

— Studio Galimberti • 2017 —



 **ORLANDO - ORL 16F**  
Ø65 x h.164 cm

The Orlando floor lamp will give a touch of incredible charm to any living room or study, and, combined with the tables of the same collection, it will fill a classic or modern home with sophisticated elegance. Its structure, adorned with refined metal inserts, features a sculptural column with vertical grooves that evoke the splendor of classical buildings.

 **COMPLEMENTARY FURNITURE** >

 **TECHNICAL FEATURES** >





Galimberti Nino

SIDE TABLE

# ORLANDO

— Studio Galimberti • 2017 —



  
ORLANDO - ORL 14D  
Ø63 x h.71 cm  
ORLANDO - ORL 15E  
Ø52 x h.53 cm

The coffee tables of the Orlando collection offer a precious and versatile exhibition area, while decorating a living room, an entrancehall or a study with traditional elegance. The round base supports a splendid fluted and sinuous column with the marble top. The metal inserts add a precious material contrast.

 | COFFEE AND  
SIDE TABLES >

 | TECHNICAL FEATURES >



Galimberti Nino

DINING TABLE

# ORLANDO

— Studio Galimberti • 2017 —



 ORLANDO - ORL 18G  
Ø110 x h.77 cm

The classic style and elegant forms blend to create an exceptional table that boasts functionality and refinement. The round top is supported by a grooved column raised on a crossed base, enriched with metal details. The perfect design to add timeless elegance to a contemporary home and fine craftsmanship of this table will make it the focal point of any ambience.

 DINING TABLES >

 TECHNICAL FEATURES >



Galimberti Nino

SIDE TABLE

# TULIPANO

— Studio Galimberti · 2015 —



TULIPANO - TUL 21A  
Ø61 x h.71 cm

Evoking the elegance of classic furniture, this side table with its simple and joyful design will enrich with the style any ambience. Crafted with utmost attention to details, this versatile item reminds with its look the shape of the tulip flower.

COFFEE AND  
SIDE TABLES >

TECHNICAL FEATURES >



Galimberti Nino

NIGHT TABLE · CHEST OF DRAWERS

# ASMARA

— Studio Galimberti · 2016 —



▶  
ASMARA - ASM 87G  
180 x 52 x h.74 cm

Timeless and sophisticated, Asmara collection will add a bright decorative accent and precious storage space to any home. Its minimalist structure is highlighted and embellished by the linear base, that gives it the lightness, and by the solid wood profile, which frames drawers and underlines the importance and preciousness of brass handles, giving a charm that has no age to these pieces.

📦 | NIGHT STORAGES >

📄 | TECHNICAL FEATURES >





▲  ASMARA - ASM 88H  
64 x 42 x h.58 cm





▲    
ASMARA - ASM 86F  
120 x 52 x h.90 cm



Galimberti Nino

WALL MIRROR

# ASTRID

— Studio Galimberti • 2017 —



 ▶  
ASTRID - AST 10A  
115 x 5 x h.172 cm

The simple silhouette of this mirror and its refined frame create a timeless, iconic piece that is a staple in any home. Either positioned in a modern entryway or a traditional bedroom, the essential lines and pure geometric proportions of this piece will add subtle elegance to any decor.

 COMPLEMENTARY  
FURNITURE >

 TECHNICAL FEATURES >



Galimberti Nino

SOFA

# EDMOND

— Studio Galimberti • 2017 —



 EDMOND - EDM 12B  
198 x 95 x h.80 cm

This elegant sofa will add a sophisticated retro vibe to any classic or modern living room while providing comfortable seating combined with stunning decorative quality. The padded structure, the delicately curved armrests and the soft lines are highlighted with the use of a wooden base with a slight visual impact.

 SOFAS >

 TECHNICAL FEATURES >







EDMOND - EDM 11A  
248 x 95 x h.80 cm



Galimberti Nino

BED

# ELLIOT

— Studio Galimberti · 2017 —



 ▶  
ELLIOT - ELL 31A  
195 x 214 x h.137 cm

Focused on simplicity with a steady eye on style, this bed of Art Deco-inspired design is enriched with luxurious details to enliven a modern and classic bedroom. The wooden frame of the upholstered headboard and the wooden base of the padded structure create a play of contrasts and materials and add the luxury touch to this piece.

 BEDS >

 TECHNICAL FEATURES >





Galimberti Nino

BED  
**ELLIOT DECÒ**

— Studio Galimberti · 2017 —



 ▶  
ELLIOT DECÒ - ELD 51A  
195 x 214 x h.137 cm

Focused on simplicity with a steady eye on style, this bed of Art Deco-inspired design is enriched with luxurious details to enliven a modern and classic bedroom. The wooden frame of the upholstered headboard and the wooden base of the padded structure create a play of contrasts and materials and add the luxury touch to this piece.

 BEDS >

 TECHNICAL FEATURES >



Galimberti Nino

SOFA

# HOLLYWOOD

— Studio Galimberti • 2008 —



HOLLYWOOD - HOL 11A  
220 x 105 x h.86 cm

The charm of traditional style and exquisite craftsmanship create a beautiful piece of decor that is both elegantly decorative and comfortably functional. The structure, completely upholstered, features a generous seat, capitonné back and curved welcoming armrests. This sofa will add a decorative and timeless touch to any living room or study.

 SOFAS >

 TECHNICAL FEATURES >







Galimberti Nino

CLUB CHAIR

# HOLLYWOOD

— Studio Galimberti • 2008 —



 **HOLLYWOOD - HOL 12B**  
103 x 105 x h.86 cm

The charm of traditional style and exquisite craftsmanship create a beautiful piece of decor that is both elegantly decorative and comfortably functional. The structure, completely upholstered, features a generous seat, capitonné back and curved welcoming armrests. This club chair will add a decorative and timeless touch to any living room or study.

 **ARMCHAIRS  
AND OTTOMANS** >

 **TECHNICAL FEATURES** >







Galimberti Nino

SOFA • MODULAR SOFA

# HUGO

— Studio Galimberti • 2017 —



 **HUGO - HUG C22**  
294 x 220 x h.68 cm

The elegant silhouette of Hugo sofas and modular sofas and their comfortable structure are the distinctive traits of these pieces that invite to relax and entertain, providing ample seating space. The straight lines of the solid wood base, the soft cushions and minimalist accents make this collection a significant presence in any interior.

 **SOFAS** >

 **TECHNICAL FEATURES** >







▲   
HUGO - HUG 23C  
212 x 104 x h.68 cm



Galimberti Nino

CHAISE LONGUE

# HUGO

— Studio Galimberti • 2017 —



 ▶  
HUGO - HUG 41U  
220 x 106 x h.68 cm

The elegant silhouette of Hugo chaises longues and their comfortable structure are the distinctive traits of these pieces that invite to relax and entertain, providing ample seating space. The straight lines of the solid wood base, the soft cushions and minimalist accents make this collection a significant presence in any interior.

 SOFAS >

 TECHNICAL FEATURES >





HUGO - HUG 40T  
220 x 106 x h.68 cm



Galimberti Nino

CLUB CHAIR • OTTOMAN

# HUGO

— Studio Galimberti • 2017 —



 ▶  
HUGO - HUG 21A  
108 x 104 x h.68 cm

The elegant silhouette of Hugo club chair and ottoman and their comfortable structure are the distinctive traits of these pieces that invite to relax and entertain, providing ample seating space. The straight lines of the solid wood base, the soft cushions and minimalist accents make this collection a significant presence in any interior.

 | **ARMCHAIRS  
AND OTTOMANS** >

 | **TECHNICAL FEATURES** >







Galimberti Nino

BED

# JACOB

— Studio Galimberti · 2017 —



 JACOB - JAC 01A  
191 x 213 x h.130 cm

The bed with its sober shape and strong character will perfectly suite both modern and classic bedrooms. The wooden base and the padded structure with the quilted headboard, enriched with the buffalo horn buttons, create the play of contrasts of materials to add sophisticated touch to this piece.

 BEDS >

 TECHNICAL FEATURES >





Galimberti Nino

BED

# JOLO

— Studio Galimberti • 2017 —



 JOLO - JOL 21A  
191 x 213 x h.150 cm

A striking addition to both classical or eclectic interiors, this sophisticated bed exudes a classic and romantic flair due to the shaped silhouette of the padded headboard, lending this piece a timeless charm.

 BEDS >

 TECHNICAL FEATURES >





Galimberti Nino

OTTOMAN

# KUBBU

— Studio Galimberti • 2017 —



KUBBU - KUB 01A  
40 x 40 x h.44 cm

The minimalist design and comfortable shape of this stunning piece make it a precious addition to both a modern and a contemporary home, where it will provide extra seating in a living room or can be used as a footrest next to an armchair in a study, in a bedroom or in an entrance hall.

 | [ARMCHAIRS  
AND OTTOMANS](#) >

 | [TECHNICAL FEATURES](#) >



Galimberti Nino

DESK  
**LUMIÈRE**

— Studio Galimberti • 2017 —



 LUMIÈRE - LUM 12B  
150 x 70 x h.76 cm

 LUMIÈRE - LUM 11A  
150 x 70 x h.85 cm

With the strong personality and timeless, this is a stunning piece for a modern or classic private studio or bedroom, where it will create a sophisticated atmosphere, thanks to its elegant materials and linear silhouette. The lacquered structure, the drawers, enriched with buffalo horn handles, and sculptural legs, underlined with brass ferrules, represent the unique and incomparable style.

 DESKS >

 TECHNICAL FEATURES >



Galimberti Nino

VANITY TABLE  
**LUMIÈRE**

— Studio Galimberti · 2017 —



  
LUMIÈRE - LUM 13C  
106 x 50 x h.76 cm

With the strong personality and timeless, this is a stunning piece for a modern or classic bedroom, where it will create a sophisticated atmosphere, thanks to its elegant materials and linear silhouette. The lacquered structure, the drawers, enriched with buffalo horn handles, and sculptural legs, underlined with brass ferrules, represent the unique and incomparable style.

 | VANITY TABLES >

 | TECHNICAL FEATURES >





Galimberti Nino

CONSOLE  
**LUMIÈRE**

— Studio Galimberti • 2017 —



 LUMIÈRE - LUM 14D  
160 x 40 x h.85 cm

With the strong personality and timeless, this is a stunning piece for a modern or classic room, where it will create a sophisticated atmosphere, thanks to its elegant materials and linear silhouette. The lacquered structure and the sculptural legs, underlined with brass ferrules, represent the unique and incomparable style.

 CONSOLES >

 TECHNICAL FEATURES >





Galimberti Nino

DINING TABLE

# MORGAN

— Studio Galimberti · 2017 —



MORGAN - MOR 23C  
Ø160 x h.76 cm

The elegance of Morgan dining table will stand out in a modern or contemporary environment, where it will be an important presence thanks to its harmonious combination of geometric and metallic elements. The lacquered base is embellished with light metal inserts that underline its formal linearity.

 DINING TABLES >

 TECHNICAL FEATURES >



Galimberti Nino

LOW COFFEE TABLE

# MORGAN

— Studio Galimberti • 2017 —



  
MORGAN - MOR 25E  
Ø130 x h.33 cm

The elegance of Morgan coffee table will stand out in a modern or contemporary environment, where it will be an important presence thanks to its harmonious combination of geometric and metallic elements. The lacquered base is embellished with light metal inserts that underline its formal linearity.

 COFFEE AND  
SIDE TABLES >

 TECHNICAL FEATURES >





Galimberti Nino

CLUB CHAIR • OTTOMAN

# TUSCANIA

— Studio Galimberti • 2012 —



  
TUSCANIA - TUS 42A  
105 x 100 x h.80 cm  
TUSCANIA - TUS 43B  
100 x 65 x h.44 cm

An exquisite mastery and respect for the charm of tradition are expressed with elegance in the Tuscania club chair and pouf, which with the gentle curves of their padding, represent an ideal addition to a classic living room, a modern study or a bedroom.

 | **ARMCHAIRS  
AND OTTOMANS** >

 | **TECHNICAL FEATURES** >



Galimberti Nino

ARMCHAIR

# BRIGITTA

— Studio Galimberti • 2010 —



 ▶  
BRIGITTA - BRI 91A  
62 x 79 x h.71 cm

A precious addition to a living room or a study, this armchair is a superb object of functional decor. An ideal piece to lounge with a good book or to enjoy the company of friends and family after dinner, this armchair features a stunning combination of comfort and elegant design.

 | [ARMCHAIRS AND OTTOMANS](#) >

 | [TECHNICAL FEATURES](#) >



Galimberti Nino

NIGHT TABLE · CHEST OF DRAWERS

# DOLCEVITA

— Studio Galimberti · 2009 —



 **DOLCEVITA - DOV 11N**  
130 x 56 x h.97 cm

The minimal and at the same time functional aesthetic defines this exquisite collection of night storages that fits perfectly in both a modern and classic ambience, thanks to its simple but elegant design. Its important structure with soft and rounded lines is lightened thanks to the slender legs with an unmistakable style. Evoking the elegance of classic d cor, these pieces feature precious brass Art Deco handles with buffalo horn inserts.

 | NIGHT STORAGES >

 | TECHNICAL FEATURES >







DOLCEVITA - DOV 12P  
61 x 41 x h.59 cm



Galimberti Nino

BENCH

# DOLCEVITA

— Studio Galimberti • 2009 —



 **DOLCEVITA - DOV 02B**  
120 x 45 x h.45 cm

With their unique style that combines retro inspiration with a modern aesthetic, these benches offer a functional touch in both a modern and neo-classic interior. Placed in an entrance hall or in a bedroom, these pieces will be an expression of style, adding the charm to any ambience.

 **ARMCHAIRS  
AND OTTOMANS** >

 **TECHNICAL FEATURES** >





▲  DOLCEVITA - DOV 03C  
52 x 40 x h.46 cm

Galimberti Nino

VANITY TABLE

# DOLCEVITA

— Studio Galimberti • 2009 —



  
DOLCEVITA - DOV 07G  
106 x 56 x h.76 cm

This vanity desk, functional and refined, blends minimalist lines and mid century flair, so that its look is both compact and aesthetically seductive. The flip-top mirror and the storage compartment in the center of the top will be appreciated for their simplicity and practicality in everyday use. Evoking the elegance of classic decor, this item features precious Art Deco brass handles with buffalo horn inserts. This piece will complement any bedroom with a timeless elegance.

 | VANITY TABLES >

 | TECHNICAL FEATURES >



Galimberti Nino

SHOWCASE · SIDEBORD

# DOLCEVITA

— Studio Galimberti · 2009 —



 DOLCEVITA - DOV 09L  
74 x 51 x h.194 cm

The minimal and at the same time functional aesthetic defines this exquisite collection of storages that fits perfectly in both a modern and classic ambience, thanks to its simple but elegant design. Its important structure with soft and rounded lines is lightened thanks to the slender legs with an unmistakable style. Evoking the elegance of classic decor, these pieces feature precious brass Art Deco handles with buffalo horn inserts.

 | STORAGES >

 | TECHNICAL FEATURES >





▲  LUMIÈRE - LUM 12B  
150 x 70 x h.76 cm



Galimberti Nino

COFFEE TABLE · SIDE TABLE

# DOLCEVITA

— Studio Galimberti · 2009 —



 DOLCEVITA - DOV 04D  
Ø85 x h.74 cm

The simple and austere lines of these coffee and side tables inspired by the 50s of the last century, convey a visual lightness that will revive both modern and classic living rooms. Their structure with soft and rounded lines is lightened thanks to the slender legs with an unmistakable style. Testimony of traditional craftsmanship, their elegant shape will create a functional support surface in every room of the house.

 COFFEE AND SIDE TABLES >

 TECHNICAL FEATURES >







DOLCEVITA - DOV 06F  
Ø50 x h.38 cm

DOLCEVITA - DOV 05E  
150 x 75 x h.49 cm



Galimberti Nino

DINING TABLE

# DOLCEVITA

— Studio Galimberti • 2009 —



DOLCEVITA - DOV 01A  
210/open 320 x 110 x h.77 cm

Evoking the elegance of classic furniture, this dining table with its simple yet chic design will elevate the style of any interior decor. A harmonious balance of sculptural aesthetic and functionality, the table, crafted with utmost attention to the details, will fit both modern and more classic, mid-century interiors.

 DINING TABLES >

 TECHNICAL FEATURES >





Galimberti Nino

SOFA

# KELLY

— Studio Galimberti • 2010 —



 ▶  
KELLY - KEL 01A  
220 x 93 x h.93 cm

Perfectly proportioned and exquisitely detailed, Kelly sofa will take center stage in any living room with its streamlined and refined silhouette. Defined by a generous seat, squared back, and flared armrests, this stunning piece of furniture is supported by six elegant feet with brass ferrules which add the sophisticated and precious accent.

 SOFAS >

 TECHNICAL FEATURES >







Galimberti Nino

CLUB CHAIR

# KELLY

— Studio Galimberti • 2010 —



  
KELLY - KEL 02B  
81 x 93 x h.93 cm

Perfectly proportioned and exquisitely detailed, Kelly club chair will take center stage in any living room with its streamlined and refined silhouette. Defined by a generous seat, squared back, and flared armrests, this stunning piece of furniture is supported by six elegant feet with brass ferrules which add the sophisticated and precious accent.

 | [ARMCHAIRS  
AND OTTOMANS](#) >

 | [TECHNICAL FEATURES](#) >



Galimberti Nino

BED

# KELLY

— Studio Galimberti • 2010 —



 **KELLY - KEL 03C**  
213 x 220 x h.110 cm

This elegant piece is an ideal bed to add comfort and a decorative and exclusive look to any bedroom. Its welcoming silhouette is distinctive for the harmonious design and softness of its headboard as well as the absence of any sharp corner. In retro style, this bed, supported by six elegant feet with brass ferrules that add the refined and precious touch, will be ideal to relax and to sleep.

 BEDS >

 TECHNICAL FEATURES >







Galimberti Nino

SOFA

# PIGRONE

— Studio Galimberti · 2012 —



PIGRONE - PGE 41A  
246 x 102 x h.92 cm

With its timeless and sophisticated design, Pigrone represents a splendid touch of refined aesthetics both in an entrance hall and in a living room with a classic or contemporary taste. Its sinuous and elegant shapes, the important backrest, the soft armrests and the generous seat express the ability to be attractive and comfortable at any time when you simply feel the need to relax or to share joyfully your time with the others.

 SOFAS >

 TECHNICAL FEATURES >



Galimberti Nino

CLUB CHAIR

# PIGRONE

— Studio Galimberti · 2012 —



 **PIGRONE - PGE 42B**  
106 x 102 x h.92 cm

With its timeless and sophisticated design, Pigrone represents a splendid touch of refined aesthetics both in an entrance hall and in a living room with a classic or contemporary taste. Its sinuous and elegant shapes, the important backrest, the soft armrests and the generous seat express the ability to be attractive and comfortable at any time when you simply feel the need to relax or to share joyfully your time with the others.

 **ARMCHAIRS  
AND OTTOMANS** >

 **TECHNICAL FEATURES** >





Galimberti Nino

ARMCHAIR · OTTOMAN

# SINATRA

— Studio Galimberti · 2009 —



  
SINATRA - SIN 01A  
80 x 90 x h.103 cm  
SINATRA - SIN 03C  
65 x 50 x h.50 cm

Inviting and sophisticated armchair and ottoman with a visual aesthetic will bring the vitality to a classic living room or a private study. The pieces with a strong personality but at the same time able to donate a comfortable seat to dedicate some moments of the day to complete relaxation.

 | **ARMCHAIRS  
AND OTTOMANS** >

 | **TECHNICAL FEATURES** >



Galimberti Nino

DINING ARM CHAIR

# SOPHIA

— Studio Galimberti • 2009 —



SOPHIA - SOP 11A  
63 x 62 x h.94 cm

Showing a classic design with a modern and elegant touch, this superb dining arm chair will complement contemporary and traditional dining rooms. The elegant shape of the structure, the backrest and the armrests with sinuous curved lines donate a visually attractive look to the seat and guarantee the perfect comfort.

 CHAIRS >

 TECHNICAL FEATURES >





TECHNICAL FEATURES

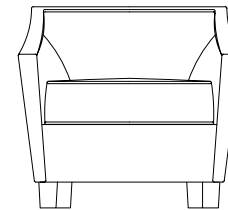

**ACQ 02B**  
Club chair

Elegance and comfort mix in a harmonious design that adds a refined touch to both a modern and a classic interior. Either in a hall or living room, as in the study or as an extra seat in the bedroom, Acquamarina club chair will be functional and decorative. The solid wood profile of the armrests gives a pleasant feeling of winding.

**Covers:** fabric / leather

**Structure finishes:** matt and glossy lacquer in the Galimberti Nino colour range

 | [VIEW ON WEBSITE](#) >

 | [GALLERY](#) >

 | [ARMCHAIRS AND OTTOMANS](#) >

 | [FINISHES](#) >

 | [UPHOLSTERY](#) >



# ACQUAMARINA | Studio Galimberti - 2014

Club chair

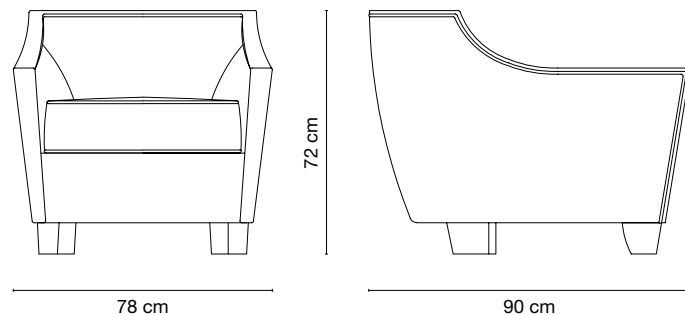
**TECHNICAL FEATURES****Structure:** solid beech wood**Seat and backrest:** padding in variable density high-resistance foam polyurethane / seat with elastic straps / non-removable cover**Cushion:** high-resistance foam polyurethane and polyester fiber lining / removable cover**Piping:** gros grain**Protective glides:** felt

Packaging	assembled	cbm.	kg.
Standard	●	0,66	25
Pallet	●	0,78	*
Wooden crate	●	1,00	*

\* weight to be confirmed

ACQ 02B	Matt lacquered				Glossy lacquered			
	M001 M002 M003 M004 M005 M014	M006 M007 M011 M012 M013 M015 M018 M019	G001 G002 G003 G004 G005 G014	G006 G007 G011 G012 G013 G015 G018 G019				
Customer's fabric mtl. 4,00	●	●	●	●				
Fabric cat. A	●	●	●	●				
Fabric cat. B	●	●	●	●				
Fabric cat. C	●	●	●	●				
Fabric cat. D	●	●	●	●				
Leather	●	●	●	●				
Leather Lux	●	●	●	●				



| GALLERY &gt;

| ARMCHAIRS AND OTTOMANS &gt;

| FINISHES &gt;

| UPHOLSTERY &gt;

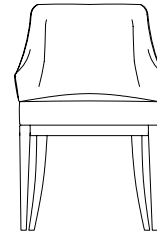

**ADE 22B**  
Dining arm chair

The Adele arm chair summarises the essence of contemporary design and the memory of tradition. Subtle elegance and timeless allure distinguish the elegant design of this versatile piece of functional decor that will make a statement in any interior, either by a dining table, behind a desk or in an entryway.

**Covers:** fabric / leather

**Base finishes:** matt and glossy lacquer in the Galimberti Nino colour range / natural walnut / honey walnut / matt and glossy tobacco walnut / matt more walnut

 | [VIEW ON WEBSITE](#) >

 | [GALLERY](#) >

 | [CHAIRS](#) >

 | [FINISHES](#) >

 | [UPHOLSTERY](#) >

Dining arm chair

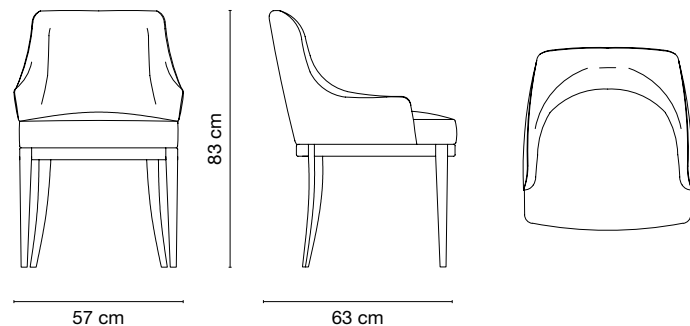
**TECHNICAL FEATURES****Structure:** solid beech wood / solid walnut**Seat and backrest:** plywood panels / padding in variable density high-resistance foam polyurethane / non-removable cover**Protective glides:** felt

Packaging	assembled	cbm.	kg.
Standard	●	0,34	14
Pallet	●	0,38	*
Wooden crate	●	0,54	*

\* weight to be confirmed

ADE 22B	Matt lacquered				Glossy lacquered				Matt walnut				Glossy walnut						
	M001 M004	M002 M005	M003 M014	M006 M013	M007 M015	M011 M018	M012 M019	G001 G004	G002 G005	G003 G014	G006 G013	G007 G015	G011 G018	G012 G019	Natural Walnut NO.020.NA	Honey Walnut NO.020.MI	Tobacco Walnut NO.020.TA	Moro Walnut NO.020.MO	Tobacco Walnut NO.100.TA
Customer's fabric mtl. 1,60	●			●				●			●			●			●		●
Fabric cat. A	●			●				●			●			●			●		●
Fabric cat. B	●			●				●			●			●			●		●
Fabric cat. C	●			●				●			●			●			●		●
Fabric cat. D	●			●				●			●			●			●		●
Leather	●			●				●			●			●			●		●
Leather Lux	●			●				●			●			●			●		●

 | GALLERY >

 | CHAIRS >

 | FINISHES >

 | UPHOLSTERY >



This elegant series of storages is part of the Ambra collection, precious and timeless pieces that can be displayed alone or combined with the other items in the same series and will be the versatile addition to any classic or contemporary home. The linear silhouette of the wooden structure is highlighted and adorned with the luxurious insert in brass, the precious material that is used for the feet ferrules and the round handles as well to add the glamorous look to these items. The drawers bottom is covered with the ecological leather for the further classy touch.

**Top and structure finishes:** matt and glossy lacquer in the Galimberti Nino colour range  
**Metal and Lolita handles finishes:** bronze painted / satin brass

 | [VIEW ON WEBSITE](#) >

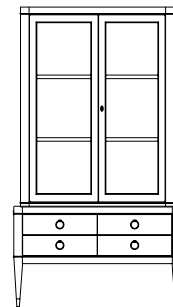

**AMB 35E**  
Showcase with drawers >

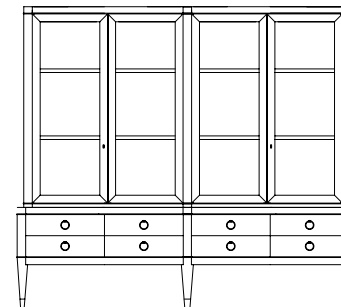

**AMB 47B**  
Bookcase >

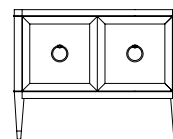

**AMB 37G**  
2 doors sideboard >

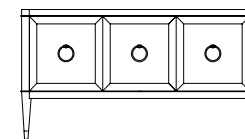

**AMB 38H**  
3 doors sideboard >

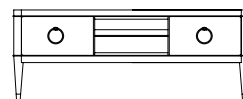

**AMB 39L**  
TV unit >

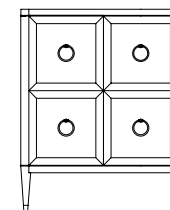



**AMB 40M**  
Bar unit >



 | [GALLERY](#) >

 | [STORAGES](#) >

 | [FINISHES](#) >

 | [UPHOLSTERY](#) >

Showcase with drawers

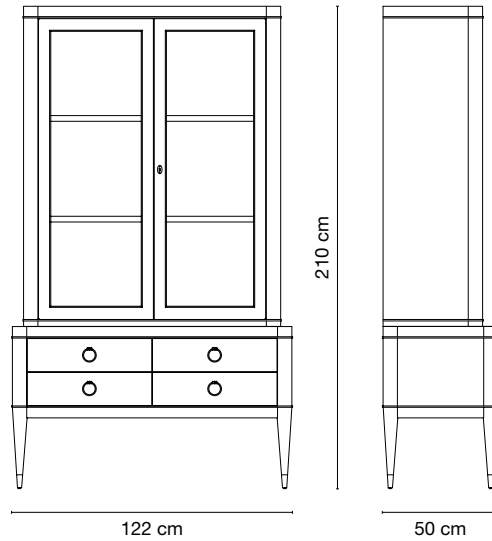

**TECHNICAL FEATURES**

**Top:** honeycomb MDF panels 50 mm thick and MDF panels  
**Structure:** MDF and chipboard panels and toulipier massive wood frames  
**Glass doors:** toulipier massive wood frames and transparent glass 4 mm thick  
**Drawers:** plywood, MDF and chipboard panels / drawer runners with Blumotion technology  
**Legs:** toulipier massive wood  
**Metal and Lolita handles:** brass  
**Protective glides:** felt

Packaging	not assembled	cbm.	kg.
Standard	●	1,52	144
Pallet	●	1,72	*
Wooden crate	●	2,28	*

\* weight to be confirmed

AMB 35E	Matt lacquered				Glossy lacquered			
	M001 M002 M003 M004 M005 M014	M006 M007 M011 M012 M013 M015 M018 M019	G001 G002 G003 G004 G005 G014	G006 G007 G011 G012 G013 G015 G018 G019				
	●	●	●	●				



| GALLERY >

| STORAGES >

| FINISHES >

| UPHOLSTERY >

Bookcase

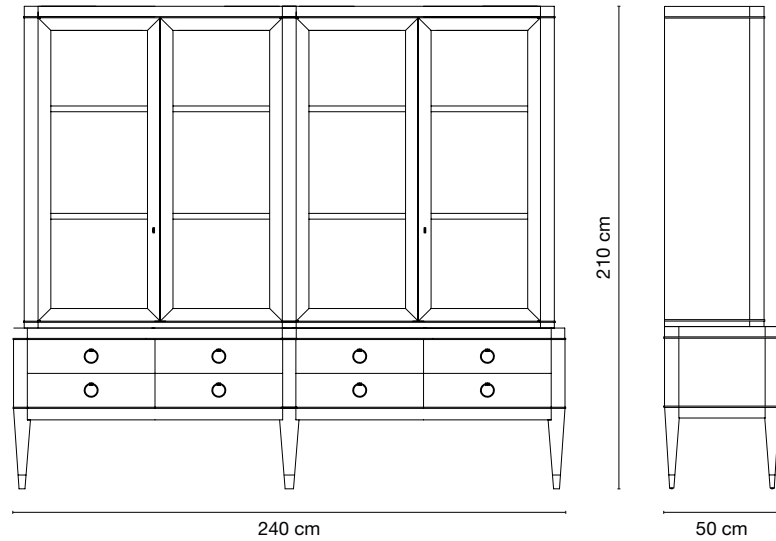

**TECHNICAL FEATURES**

- Top:** honeycomb MDF panels 50 mm thick
- Structure:** MDF and chipboard panels and toulipier massive wood frames
- Glass doors:** toulipier massive wood frames and transparent glass 4 mm thick
- Wooden doors:** MDF panels
- Legs:** toulipier massive wood
- Metal and Lolita handles:** brass
- Protective glides:** felt

Packaging	not assembled	cbm.	kg.
Standard	●	3,08	250
Pallet	●	3,52	*
Wooden crate	●	4,60	*

\* weight to be confirmed

AMB 47B	Matt lacquered				Glossy lacquered			
	M001 M002 M003 M004 M005 M014	M006 M007 M011 M012 M013 M015 M018 M019	G001 G002 G003 G004 G005 G014	G006 G007 G011 G012 G013 G015 G018 G019				
	●	●	●	●				



| GALLERY >

| STORAGES >

| FINISHES >

| UPHOLSTERY >

2 doors sideboard

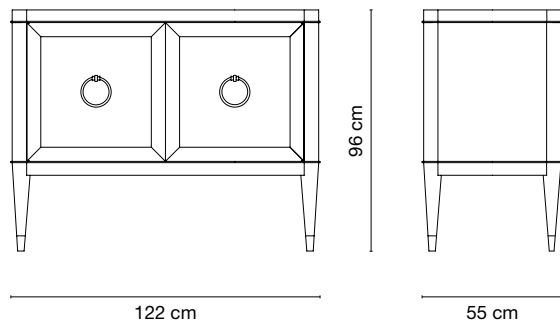

**TECHNICAL FEATURES**





**Top:** honeycomb MDF panels 50 mm thick  
**Structure:** MDF and chipboard panels with toulipier massive wood frames  
**Doors:** toulipier massive wood and MDF panels  
**Legs:** toulipier massive wood  
**Metal and Lolita handles:** brass  
**Protective glides:** felt

Packaging	assembled	cbm.	kg.
Standard	●	0,82	64
Pallet	●	0,94	*
Wooden crate	●	1,24	*

\* weight to be confirmed

AMB 37G	Matt lacquered				Glossy lacquered			
	M001 M002 M003 M004 M005 M014	M006 M007 M011 M012 M013 M015 M018 M019	G001 G002 G003 G004 G005 G014	G006 G007 G011 G012 G013 G015 G018 G019				
	●	●	●	●				



-  | GALLERY >
-  | STORAGES >
-  | FINISHES >
-  | UPHOLSTERY >

3 doors sideboard

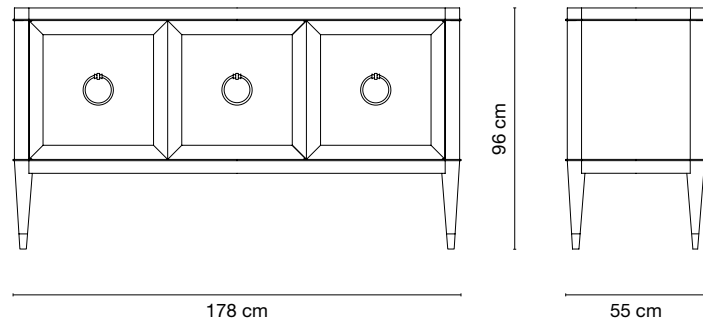

### TECHNICAL FEATURES

**Top:** honeycomb MDF panels 50 mm thick

**Structure:** MDF and chipboard panels with toulipier massive wood frames

**Doors:** toulipier massive wood and MDF panels

**Legs:** toulipier massive wood

**Metal and Lolita handles:** brass

**Protective glides:** felt

Packaging	assembled	cbm.	kg.
Standard	●	1,28	115
Pallet	●	1,46	*
Wooden crate	●	1,84	*

\* weight to be confirmed

AMB 38H	Matt lacquered				Glossy lacquered			
	M001 M002 M003 M004 M005 M014	M006 M007 M011 M012 M013 M015 M018 M019	G001 G002 G003 G004 G005 G014	G006 G007 G011 G012 G013 G015 G018 G019				
	●	●	●	●				



| GALLERY >

| STORAGES >

| FINISHES >

| UPHOLSTERY >



TV unit

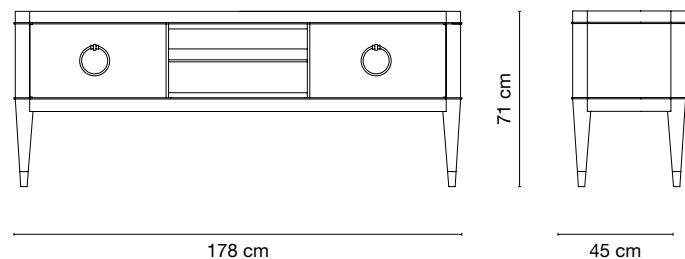

### TECHNICAL FEATURES

**Top:** honeycomb MDF panels 50 mm thick

**Structure:** MDF and chipboard panels with toulipier massive wood frames

**Doors:** MDF panels

**Legs:** toulipier massive wood

**Metal and Lolita handles:** brass

**Protective glides:** felt

Packaging	assembled	cbm.	kg.
Standard	●	0,82	82
Pallet	●	0,98	*
Wooden crate	●	1,28	*

\* weight to be confirmed

AMB 39L	Matt lacquered				Glossy lacquered			
	M001 M002 M003 M004 M005 M014	M006 M007 M011 M012 M013 M015 M018 M019	G001 G002 G003 G004 G005 G014	G006 G007 G011 G012 G013 G015 G018 G019				
	●	●	●	●				



| GALLERY >

| STORAGES >

| FINISHES >

| UPHOLSTERY >

Bar unit

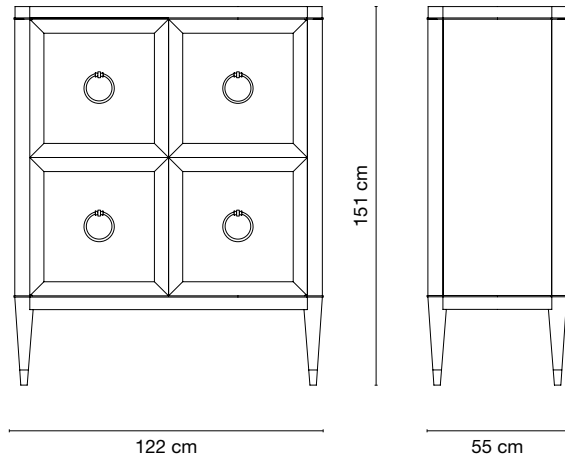

**TECHNICAL FEATURES**

**Top:** honeycomb MDF panels 50 mm thick

**Structure and drawers:** plywood, MDF and chipboard panels with toulipier massive wood frames / drawer runners with Blumotion technology

**Doors:** toulipier massive wood and MDF panels

**Legs:** toulipier massive wood

**Metal and Lolita handles:** brass

**Protective glides:** felt

Packaging	assembled	cbm.	kg.
Standard	●	1,30	116
Pallet	●	1,42	*
Wooden crate	●	1,82	*

\* weight to be confirmed

AMB 40M	Matt lacquered				Glossy lacquered			
	M001 M002 M003 M004 M005 M014	M006 M007 M011 M012 M013 M015 M018 M019	G001 G002 G003 G004 G005 G014	G006 G007 G011 G012 G013 G015 G018 G019				
	●	●	●	●				



| GALLERY >

| STORAGES >

| FINISHES >

| UPHOLSTERY >



This elegant series of night tables and chests of drawers is part of the Ambra collection, precious and timeless pieces that can be displayed alone or combined with the other items in the same series and will be the versatile addition to any classic or contemporary home. The linear silhouette of the wooden structure is highlighted and adorned with the luxurious insert in brass, the precious material that is used for the feet ferrules and the round handles as well to add the glamorous look to these items. The drawers bottom is covered with the ecological leather for the further classy touch.

**Top and structure finishes:** matt and glossy lacquer in the Galimberti Nino colour range  
**Metal and Lolita handles finishes:** bronze painted / satin brass

| [VIEW ON WEBSITE](#) >

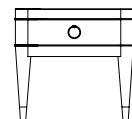

**AMB 44R**  
1 drawer night table >

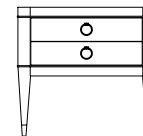

**AMB 45S**  
2 drawers night table >

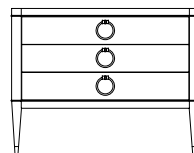

**AMB 41N**  
Chest of 3 drawers >

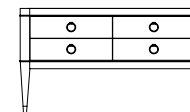

**AMB 42P**  
Chest of 4 drawers >

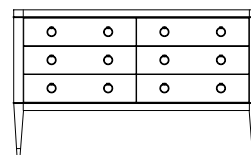

**AMB 43Q**  
Chest of 6 drawers >

| [GALLERY](#) >

| [NIGHT STORAGES](#) >

| [FINISHES](#) >

| [UPHOLSTERY](#) >

1 drawer night table

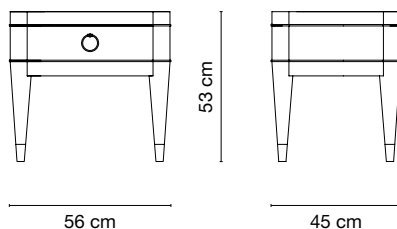

**TECHNICAL FEATURES**



**Top:** honeycomb MDF panels 50 mm thick  
**Structure and drawers:** plywood, MDF and chipboard panels with toulipier massive wood frames / drawer runners with Blumotion technology  
**Legs:** toulipier massive wood  
**Metal and Lolita handles:** brass  
**Protective glides:** felt

Packaging	assembled	cbm.	kg.
Standard	●	0,22	26
Pallet	●	0,28	*
Wooden crate	●	0,40	*

\* weight to be confirmed

AMB 44R	Matt lacquered				Glossy lacquered			
	M001 M002 M003 M004 M005 M014	M006 M007 M011 M012 M013 M015 M018 M019	G001 G002 G003 G004 G005 G014	G006 G007 G011 G012 G013 G015 G018 G019				
	●	●	●	●				



-  | GALLERY >
-  | NIGHT STORAGES >
-  | FINISHES >
-  | UPHOLSTERY >

2 drawers night table

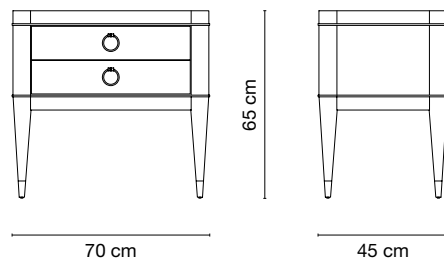

**TECHNICAL FEATURES**



**Top:** honeycomb MDF panels 50 mm thick  
**Structure and drawers:** plywood, MDF and chipboard panels with toulipier massive wood frames / drawer runners with Blumotion technology  
**Legs:** toulipier massive wood  
**Metal and Lolita handles:** brass  
**Protective glides:** felt

Packaging	assembled	cbm.	kg.
Standard	●	0,32	35
Pallet	●	0,38	*
Wooden crate	●	0,54	*

\* weight to be confirmed

AMB 45S	Matt lacquered				Glossy lacquered			
	M001 M002 M003 M004 M005 M014	M006 M007 M011 M012 M013 M015 M018 M019	G001 G002 G003 G004 G005 G014	G006 G007 G011 G012 G013 G015 G018 G019				
	●	●	●	●				



-  | GALLERY >
-  | NIGHT STORAGES >
-  | FINISHES >
-  | UPHOLSTERY >

Chest of 3 drawers

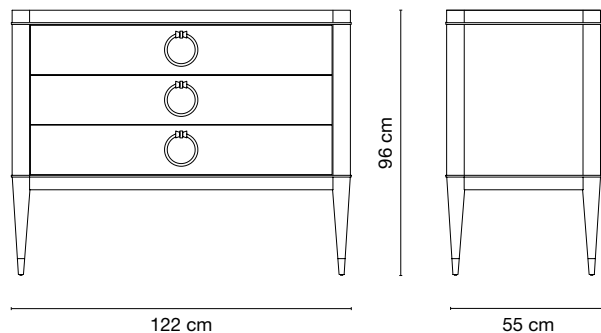

**TECHNICAL FEATURES**





**Top:** honeycomb MDF panels 50 mm thick  
**Structure and drawers:** plywood, MDF and chipboard panels with toulpier massive wood frames / drawer runners with Blumotion technology  
**Legs:** toulpier massive wood  
**Metal and Lolita handles:** brass  
**Protective glides:** felt

Packaging	assembled	cbm.	kg.
Standard	●	0,82	90
Pallet	●	0,94	*
Wooden crate	●	1,24	*

\* weight to be confirmed

AMB 41N	Matt lacquered				Glossy lacquered			
	M001 M002 M003 M004 M005 M014	M006 M007 M011 M012 M013 M015 M018 M019	G001 G002 G003 G004 G005 G014	G006 G007 G011 G012 G013 G015 G018 G019				
	●	●	●	●				



-  | GALLERY >
-  | NIGHT STORAGES >
-  | FINISHES >
-  | UPHOLSTERY >

Chest of 4 drawers

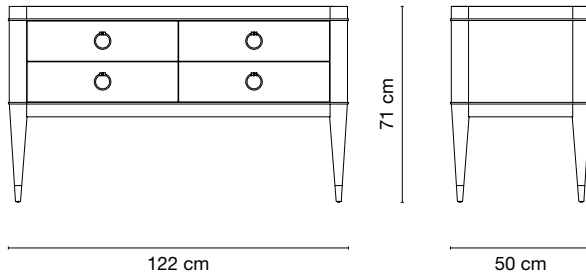

**TECHNICAL FEATURES**

**Top:** honeycomb MDF panels 50 mm thick  
**Structure and drawers:** plywood, MDF and chipboard panels with toulpier massive wood frames / drawer runners with Blumotion technology  
**Legs:** toulpier massive wood  
**Metal and Lolita handles:** brass  
**Protective glides:** felt

Packaging	assembled	cbm.	kg.
Standard	●	0,64	68
Pallet	●	0,76	*
Wooden crate	●	0,98	*

\* weight to be confirmed

AMB 42P	Matt lacquered				Glossy lacquered			
	M001 M002 M003 M004 M005 M014	M006 M007 M011 M012 M013 M015 M018 M019	G001 G002 G003 G004 G005 G014	G006 G007 G011 G012 G013 G015 G018 G019				
	●	●	●	●				



-  | GALLERY >
-  | NIGHT STORAGES >
-  | FINISHES >
-  | UPHOLSTERY >

Chest of 6 drawers

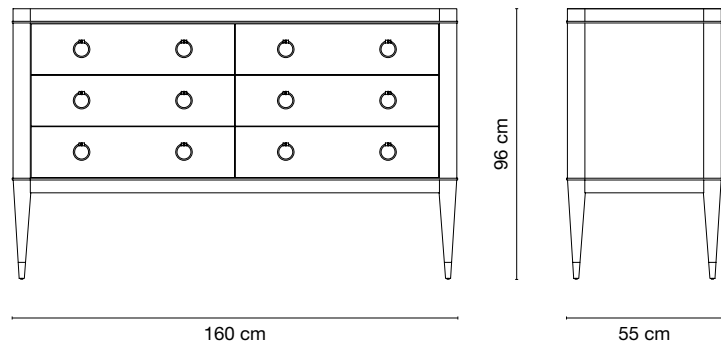

**TECHNICAL FEATURES**





**Top:** honeycomb MDF panels 50 mm thick  
**Structure and drawers:** plywood, MDF and chipboard panels with toulipier massive wood frames / drawer runners with Blumotion technology  
**Legs:** toulipier massive wood  
**Metal and Lolita handles:** brass  
**Protective glides:** felt

Packaging	assembled	cbm.	kg.
Standard	●	1,08	126
Pallet	●	1,24	*
Wooden crate	●	1,58	*

\* weight to be confirmed

AMB 43Q	Matt lacquered				Glossy lacquered			
	M001 M002 M003 M004 M005 M014	M006 M007 M011 M012 M013 M015 M018 M019	G001 G002 G003 G004 G005 G014	G006 G007 G011 G012 G013 G015 G018 G019				
	●	●	●	●				



-  | GALLERY >
-  | NIGHT STORAGES >
-  | FINISHES >
-  | UPHOLSTERY >





The writing desk of the Ambra collection is a precious piece of furniture that boasts a retro-chic allure and exquisite details, it will decorate any ambience with its refined elegance. The linear silhouette of the wooden structure is underlined and decorated with the luxurious insert in brass, the precious material that is used for the feet ferrules and the handles as well to add the glamorous look to this item. The drawers bottom is covered with the ecological leather for the further classy touch.

**Structure finishes:** matt and glossy lacquer in the Galimberti Nino colour range

**Desk top cover:** leather

**Metal and Lolita handles finishes:** bronze painted / satin brass

 | [VIEW ON WEBSITE](#) >

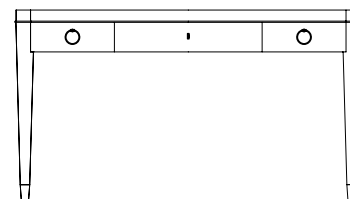



**AMB 33C**  
Desk >



 | [GALLERY](#) >

 | [DESKS](#) >

 | [FINISHES](#) >

 | [UPHOLSTERY](#) >

Desk

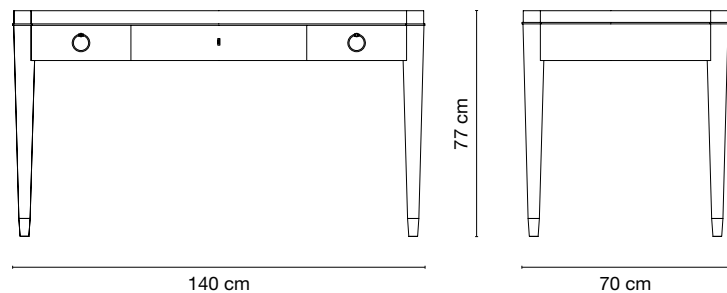

**TECHNICAL FEATURES**

**Top:** honeycomb MDF panel  
**Structure and drawers:** plywood, MDF and chipboard panels / drawer runners with Blumotion technology  
**Legs:** toulipier massive wood  
**Metal and Lolita handles:** brass  
**Protective glides:** felt

Packaging	assembled	cbm.	kg.
Standard	●	1,00	70
Pallet	●	1,16	*
Wooden crate	●	1,48	*

\* weight to be confirmed

AMB 33C	Matt lacquered				Glossy lacquered			
	M001 M002 M003 M004 M005 M014	M006 M007 M011 M012 M013 M015 M018 M019	G001 G002 G003 G004 G005 G014	G006 G007 G011 G012 G013 G015 G018 G019				
Leather	●	●	●	●				
Leather Lux	●	●	●	●				

- | GALLERY >
- | DESKS >
- | FINISHES >
- | UPHOLSTERY >



The vanity table of the Ambra collection is a precious piece of furniture that boasts a retro-chic allure and exquisite details, it will decorate any ambience with its refined elegance. The linear silhouette of the wooden structure is underlined and decorated with the luxurious insert in brass, the precious material that is used for the feet ferrules and the handles as well to add the glamorous look to this item. The drawers bottom is covered with the ecological leather for the further classy touch.

**Structure finishes:** matt and glossy lacquer in the Galimberti Nino colour range  
**Metal and Lolita handles finishes:** bronze painted / satin brass

 | [VIEW ON WEBSITE](#) >

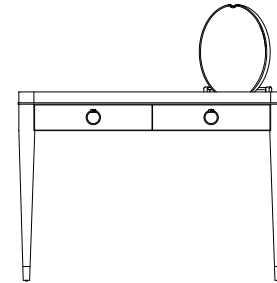

**AMB 34D**  
Vanity table >

 | [GALLERY](#) >

 | [VANITY TABLES](#) >

 | [FINISHES](#) >

 | [UPHOLSTERY](#) >

Vanity table

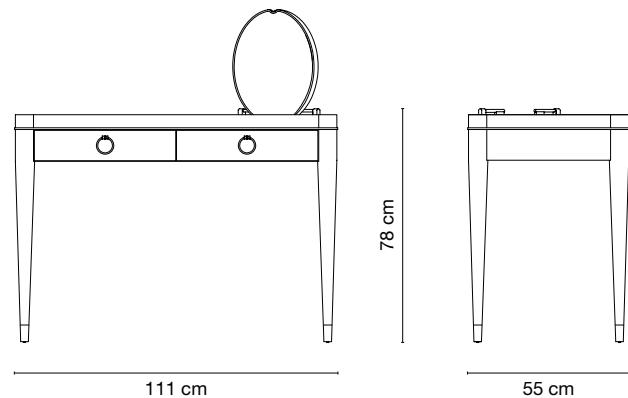

### TECHNICAL FEATURES

**Top:** honeycomb MDF panel 50 mm thick

**Structure and drawers:** plywood, MDF and chipboard panels / drawer runners with Blumotion technology

**Legs:** toulipier massive wood

**Metal and Lolita handles:** brass

**Protective glides:** felt

Packaging	assembled	cbm.	kg.
Standard	●	0,68	55
Pallet	●	0,78	*
Wooden crate	●	1,04	*

\* weight to be confirmed

AMB 34D	Matt lacquered				Glossy lacquered			
	M001 M002 M003 M004 M005 M014	M006 M007 M011 M012 M013 M015 M018 M019	G001 G002 G003 G004 G005 G014	G006 G007 G011 G012 G013 G015 G018 G019				
	●	●	●	●				



| GALLERY >

| VANITY TABLES >

| FINISHES >

| UPHOLSTERY >

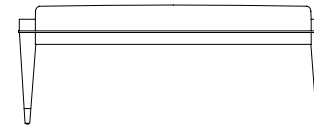

**AMB 31A**  
Bench >

This stunning bench is an exquisite statement piece for either a modern or a classic bedroom or entrance hall. Part of the Ambra collection, it can be combined with the others in the same series. The glamorous looking wooden structure has the perimeter brass inserts and four tapered legs adorned with feet in brass.

**Covers:** fabric / leather

**Base finishes:** matt and glossy lacquer in the Galimberti Nino colour range

**Metal finishes:** bronze painted / satin brass

 | [VIEW ON WEBSITE](#) >

 | [GALLERY](#) >

 | [ARMCHAIRS AND OTTOMANS](#) >

 | [FINISHES](#) >

 | [UPHOLSTERY](#) >

## Bench

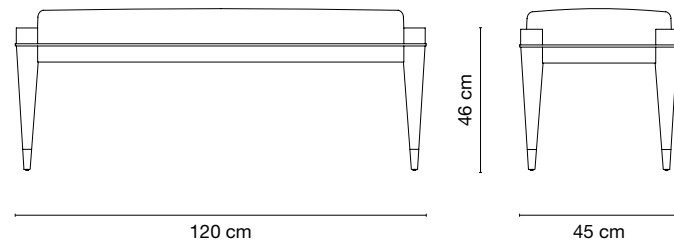
**TECHNICAL FEATURES**

**Structure:** toulipier massive wood and MDF panels

**Legs:** toulipier massive wood

**Seat:** plywood panel / padding in variable density high-resistance foam polyurethane / non-removable cover

**Metal and legs ferrules:** brass

**Protective glides:** felt

Packaging	assembled	cbm.	kg.
Standard	●	0,40	19
Pallet	●	0,52	*
Wooden crate	●	0,70	*

\* weight to be confirmed

AMB 31A	Matt lacquered				Glossy lacquered			
	M001 M002 M003 M004 M005 M014	M006 M007 M011 M012 M013 M015 M018 M019	G001 G002 G003 G004 G005 G014	G006 G007 G011 G012 G013 G015 G018 G019				
Customer's fabric mtl. 1,00	●	●	●	●				
Fabric cat. A	●	●	●	●				
Fabric cat. B	●	●	●	●				
Fabric cat. C	●	●	●	●				
Fabric cat. D	●	●	●	●				
Leather	●	●	●	●				
Leather Lux	●	●	●	●				



| GALLERY >

| ARMCHAIRS AND OTTOMANS >

| FINISHES >

| UPHOLSTERY >



This stunning coffee table is an exquisite statement piece for either a modern or a classic living room. The linear silhouette of the wooden structure is underlined and decorated with the luxurious insert in brass, the precious material that is used for the feet ferrules as well to add the glamorous look to this item.

**Top and structure finishes:** matt and glossy lacquer in the Galimberti Nino colour range  
**Metal finishes:** bronze painted / satin brass

 | [VIEW ON WEBSITE](#) >



**AMB 32B**  
Coffee table >

 | [GALLERY](#) >

 | [COFFEE AND SIDE TABLES](#) >

 | [FINISHES](#) >

 | [UPHOLSTERY](#) >

Coffee table

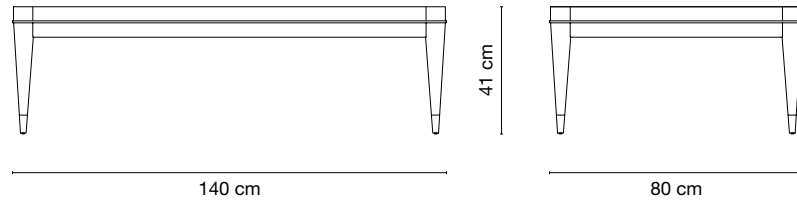





**TECHNICAL FEATURES**

**Top:** honeycomb MDF panel 50 mm thick  
**Structure:** toulipier massive wood  
**Legs:** toulipier massive wood  
**Metal and legs ferrules:** brass  
**Protective glides:** felt

Packaging	assembled	cbm.	kg.
Standard	●	0,56	37
Pallet	●	0,74	*
Wooden crate	●	0,96	*

\* weight to be confirmed

AMB 32B	Matt lacquered				Glossy lacquered			
	M001 M002 M003 M004 M005 M014	M006 M007 M011 M012 M013 M015 M018 M019	G001 G002 G003 G004 G005 G014	G006 G007 G011 G012 G013 G015 G018 G019				
	●	●	●	●				

-  | GALLERY >
-  | COFFEE AND SIDE TABLES >
-  | FINISHES >
-  | UPHOLSTERY >



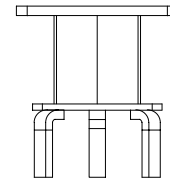

**AND 51B**  
Side table

A stunning piece of functional decor that boasts a sculptural silhouette and exquisite craftsmanship, this side table is versatile and elegant and can be displayed in any room in the house. Its dynamic silhouette is crafted of wood with a walnut veneer. Its curved legs are adorned with metal inserts.

**Top and structure finishes:** natural walnut / honey walnut / matt and glossy tobacco walnut / moro walnut

**Metal finishes:** matt black

 | [VIEW ON WEBSITE](#) >

 | [GALLERY](#) >

 | [COFFEE AND SIDE TABLES](#) >

 | [FINISHES](#) >

 | [UPHOLSTERY](#) >

## Side table

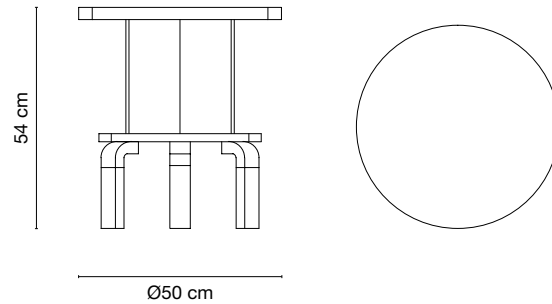
**TECHNICAL FEATURES**

**Top and structure:** chipboard panels covered with walnut wood veneer

**Legs:** solid walnut

**Insets:** painted metal

**Protective glides:** felt

Packaging	assembled	cbm.	kg.
Standard	●	0,20	12
Pallet	●	0,24	*
Wooden crate	●	0,34	*

\* weight to be confirmed

AND 51B	Matt walnut				Glossy walnut
	Natural Walnut NO.020.NA	Honey Walnut NO.020.MI	Tobacco Walnut NO.020.TA	Moro Walnut NO.020.MO	Tobacco Walnut NO.100.TA
Matt black metal	●	●	●	●	●

 | GALLERY >

 | COFFEE AND SIDE TABLES >

 | FINISHES >

 | UPHOLSTERY >

ANEMONE | Studio Galimberti - 2015

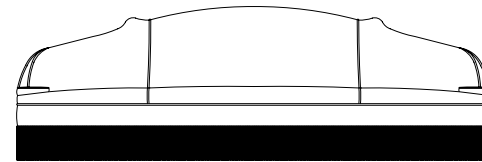



ANE 11A  
Sofa >

The Anemone sofa will express its superb elegance in any modern or classic ambience, thanks to its precious presence and its great comfort. The unique and sinuous shape of its structure, precious covered, has rounded and soft corners, and it's enriched by the fascinating fringe decoration that adds a surprising sense of movement under the seat.

Covers: fabric

 | [VIEW ON WEBSITE](#) >

 | [GALLERY](#) >

 | [SOFAS](#) >

 | [FINISHES](#) >

 | [UPHOLSTERY](#) >

## ANEMONE | Studio Galimberti - 2015

Sofa

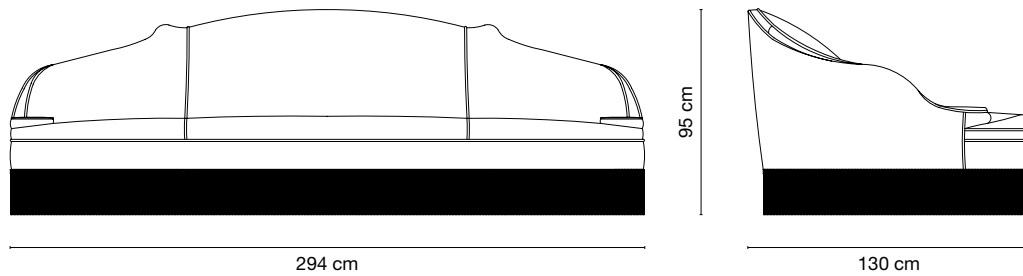
**TECHNICAL FEATURES****Structure:** solid wood and plywood panels**Seat and backrest:** padding in variable density high-resistance foam polyurethane / seat with elastic straps / non-removable cover**Piping:** gros grain**Base:** adjustable feet with nylon protective glides / fringe trimming

Packaging	assembled	cbm.	kg.
Standard	●	4,26	115
Pallet	●	4,86	*
Wooden crate	●	5,62	*

*\* weight to be confirmed*

ANE 11A		
Customer's fabric mtl. 12,00	●	
Fabric cat. A	●	
Fabric cat. B	●	
Fabric cat. C	●	
Fabric cat. D	●	

[GALLERY](#) >

[SOFAS](#) >

[FINISHES](#) >

[UPHOLSTERY](#) >

**ANEMONE** | Studio Galimberti - 2015



The Anemone ottoman will express its superb elegance in any modern or classic ambience, thanks to its precious presence and its great comfort. The unique and sinuous shape of its structure, preciously covered, has rounded and soft corners, and it's enriched by the fascinating fringe decoration that adds a surprising sense of movement under the seat.

**Covers:** fabric

 | [VIEW ON WEBSITE](#) >

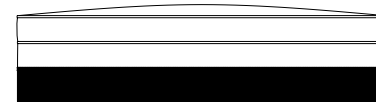

**ANE 12B**  
Ottoman >

 | [GALLERY](#) >

 | [ARMCHAIRS AND OTTOMANS](#) >

 | [FINISHES](#) >

 | [UPHOLSTERY](#) >

## ANEMONE | Studio Galimberti - 2015

Ottoman

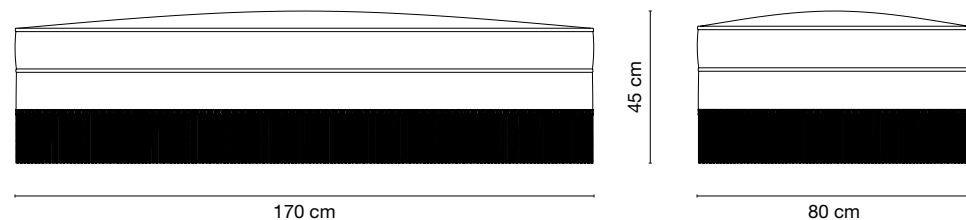
**TECHNICAL FEATURES****Structure:** solid wood and plywood panels**Seat:** padding in variable density high-resistance foam polyurethane / seat with elastic straps / non-removable cover**Piping:** gros grain**Base:** adjustable feet with nylon protective glides / fringe trimming

Packaging	assembled	cbm.	kg.
Standard	●	0,86	34
Pallet	●	1,08	*
Wooden crate	●	1,36	*

\* weight to be confirmed

ANE 12B		
Customer's fabric mtl. 3,00	●	
Fabric cat. A	●	
Fabric cat. B	●	
Fabric cat. C	●	
Fabric cat. D	●	



| GALLERY &gt;

| ARMCHAIRS AND OTTOMANS &gt;

| FINISHES &gt;

| UPHOLSTERY &gt;



A unique and sophisticated accent to a classic or contemporary interior, these night and lounge tables will imbue with brilliance a bedroom, also creating a functional space to store books or everyday objects. Their striking contrast between the warm wooden top and the sculptural base creates a look that is both classic and innovative.

**Top and column finishes:** natural walnut / honey walnut / matt and glossy tobacco walnut / moro walnut

**Base finishes:** matt black

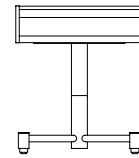

**ARG 07S**  
Night table >

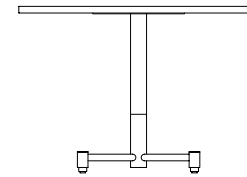

**ARG 23A**  
Lounge table Ø90 >

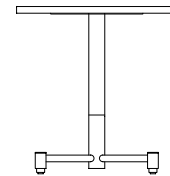

**ARG 11D**  
Lounge table >

| [VIEW ON WEBSITE](#) >

| [GALLERY](#) >

| [COFFEE AND SIDE TABLES](#) >

| [FINISHES](#) >

| [UPHOLSTERY](#) >

Night table

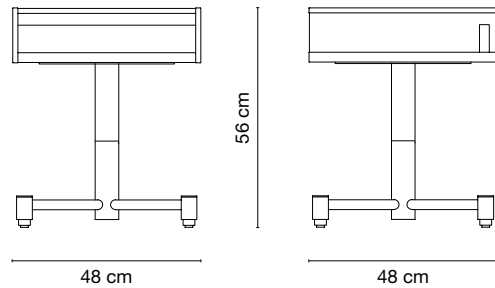

**TECHNICAL FEATURES**

**Top and structure:** chipboard panels covered with walnut wood veneer

**Column:** solid walnut

**Base:** painted metal

**Protective glides:** soft non-scratch rubber

Packaging	assembled	cbm.	kg.
Standard	●	0,20	16
Pallet	●	0,26	*
Wooden crate	●	0,36	*

\* weight to be confirmed

ARG 07S	Matt walnut				Glossy walnut
	Natural Walnut NO.020.NA	Honey Walnut NO.020.MI	Tobacco Walnut NO.020.TA	Moro Walnut NO.020.MO	Tobacco Walnut NO.100.TA
Matt black metal	●	●	●	●	●



| GALLERY >

| COFFEE AND SIDE TABLES >

| FINISHES >

| UPHOLSTERY >



Lounge table Ø90

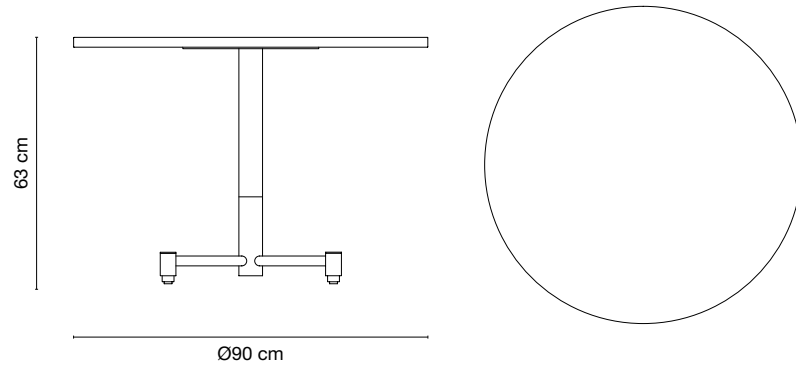

### TECHNICAL FEATURES

**Top:** chipboard panels covered with walnut wood veneer

**Column:** solid walnut

**Base:** painted metal

**Protective glides:** soft non-scratch rubber

Packaging	not assembled	cbm.	kg.	assembled	cbm.	kg.
Standard	●	0,28	23			
Pallet**	●	0,30	*			
Wooden crate				●	1,00	*

\* weight to be confirmed \*\* top not included

ARG 23A	Matt walnut				Glossy walnut
	Natural Walnut NO.020.NA	Honey Walnut NO.020.MI	Tobacco Walnut NO.020.TA	Moro Walnut NO.020.MO	Tobacco Walnut NO.100.TA
Matt black metal	●	●	●	●	●



| GALLERY >

| COFFEE AND SIDE TABLES >

| FINISHES >

| UPHOLSTERY >

Lounge table

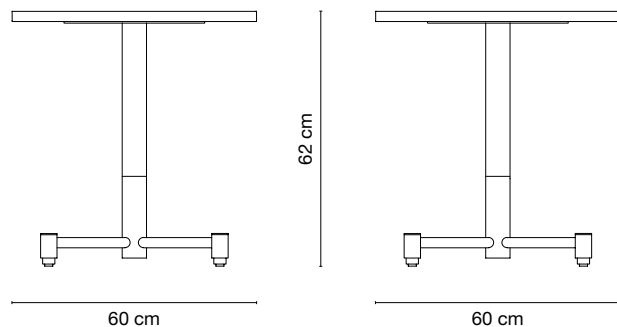

**TECHNICAL FEATURES**

**Top:** chipboard panels covered with walnut wood veneer

**Column:** solid walnut

**Base:** painted metal

**Protective glides:** soft non-scratch rubber

Packaging	assembled	cbm.	kg.
Standard	●	0,30	15
Pallet	●	0,36	*
Wooden crate	●	0,52	*

\* weight to be confirmed

ARG 11D	Matt walnut				Glossy walnut
	Natural Walnut NO.020.NA	Honey Walnut NO.020.MI	Tobacco Walnut NO.020.TA	Moro Walnut NO.020.MO	Tobacco Walnut NO.100.TA
Matt black metal	●	●	●	●	●



| GALLERY >

| COFFEE AND SIDE TABLES >

| FINISHES >

| UPHOLSTERY >



Timeless and sophisticated, Asmara collection will add a bright decorative accent and precious storage space to any home. Its minimalist structure is highlighted and embellished by the linear base, that gives it the lightness, and by the solid wood profile, which frames doors and underlines the importance and preciousness of brass handles, giving a charm that has no age to these pieces.

**Top and structure finishes:** matt and glossy lacquer in the Galimberti Nino colour range / natural walnut / honey walnut / matt and glossy tobacco walnut / moro walnut

**Lolita handles finishes:** bronze painted / satin brass

 | [VIEW ON WEBSITE](#) >

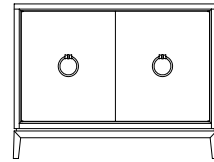

**ASM 82B**  
2 doors sideboard >

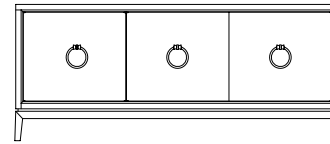

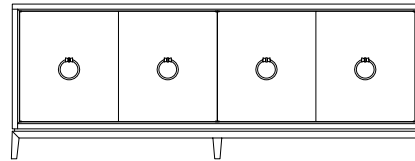

**ASM 83C**  
3 doors sideboard >





**ASM 84D**  
4 doors sideboard >



 | [GALLERY](#) >

 | [STORAGES](#) >

 | [FINISHES](#) >

 | [UPHOLSTERY](#) >

2 doors sideboard

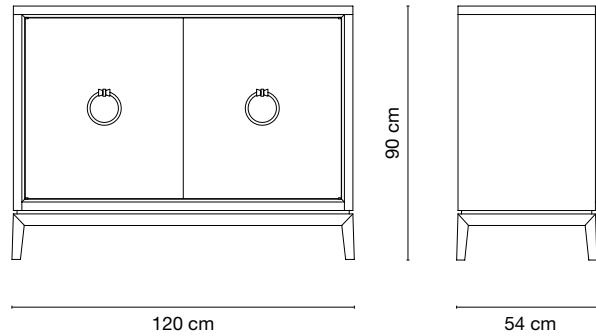

### TECHNICAL FEATURES

**Top, structure and doors:** honeycomb MDF, MDF and chipboard panels / honeycomb MDF, MDF and chipboard panels covered with walnut wood veneer

**Base and profiles:** toulipier massive wood / solid walnut

**Internal shelves:** transparent glass 8 mm thick

**Lolita handles:** brass

**Protective glides:** felt

Packaging	assembled	cbm.	kg.
Standard	●	0,76	66
Pallet	●	0,88	*
Wooden crate	●	1,14	*

\* weight to be confirmed

ASM 82B	Matt lacquered				Glossy lacquered				Matt walnut				Glossy walnut
	M001 M002 M003 M004 M005 M014	M006 M007 M011 M012 M013 M015 M018 M019	G001 G002 G003 G004 G005 G014	G006 G007 G011 G012 G013 G015 G018 G019	Natural Walnut NO.020.NA	Honey Walnut NO.020.MI	Tobacco Walnut NO.020.TA	Moro Walnut NO.020.MO	Tobacco Walnut NO.100.TA				
	●	●	●	●	●	●	●	●	●				



| GALLERY >

| STORAGES >

| FINISHES >

| UPHOLSTERY >

3 doors sideboard

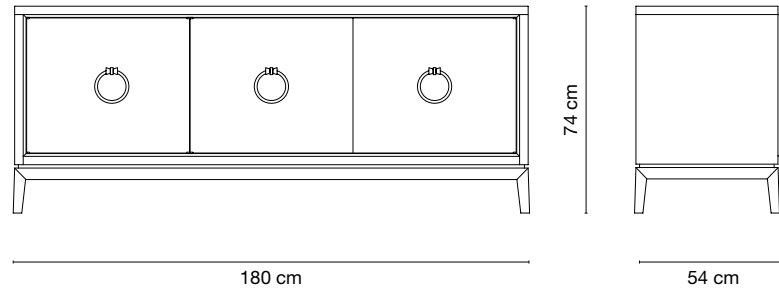

### TECHNICAL FEATURES

**Top, structure and doors:** honeycomb MDF, MDF and chipboard panels / honeycomb MDF, MDF and chipboard panels covered with walnut wood veneer  
**Base and profiles:** toulipier massive wood / solid walnut  
**Internal shelves:** transparent glass 8 mm thick  
**Lolita handles:** brass  
**Protective glides:** felt

Packaging	assembled	cbm.	kg.
Standard	●	0,98	95
Pallet	●	1,14	*
Wooden crate	●	1,48	*

\* weight to be confirmed

ASM 83C	Matt lacquered				Glossy lacquered				Matt walnut				Glossy walnut
	M001 M002 M003 M004 M005 M014	M006 M007 M011 M012 M013 M015 M018 M019	G001 G002 G003 G004 G005 G014	G006 G007 G011 G012 G013 G015 G018 G019	Natural Walnut NO.020.NA	Honey Walnut NO.020.MI	Tobacco Walnut NO.020.TA	Moro Walnut NO.020.MO	Tobacco Walnut NO.100.TA				
	●	●	●	●	●	●	●	●	●				

- | GALLERY >
- | STORAGES >
- | FINISHES >
- | UPHOLSTERY >

4 doors sideboard

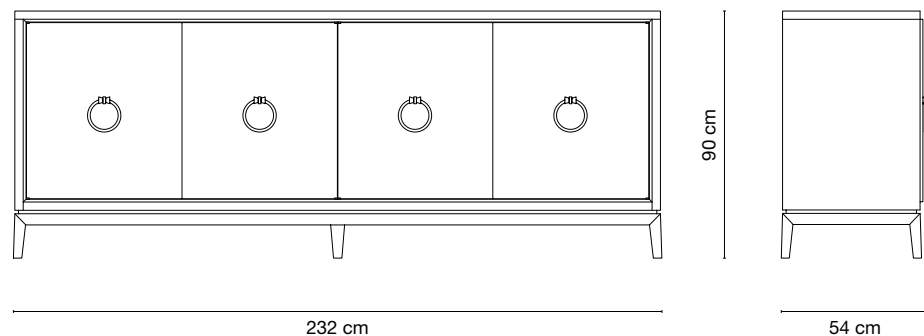

### TECHNICAL FEATURES

**Top, structure and doors:** honeycomb MDF, MDF and chipboard panels / honeycomb MDF, MDF and chipboard panels covered with walnut wood veneer  
**Base and profiles:** toulipier massive wood / solid walnut  
**Internal shelves:** transparent glass 8 mm thick  
**Lolita handles:** brass  
**Protective glides:** felt

Packaging	assembled	cbm.	kg.
Standard	●	1,44	134
Pallet	●	1,66	*
Wooden crate	●	2,10	*

\* weight to be confirmed

ASM 84D	Matt lacquered				Glossy lacquered				Matt walnut				Glossy walnut
	M001 M002 M003 M004 M005 M014	M006 M007 M011 M012 M013 M015 M018 M019	G001 G002 G003 G004 G005 G014	G006 G007 G011 G012 G013 G015 G018 G019	Natural Walnut NO.020.NA	Honey Walnut NO.020.MI	Tobacco Walnut NO.020.TA	Moro Walnut NO.020.MO	Tobacco Walnut NO.100.TA				
	●	●	●	●	●	●	●	●	●				

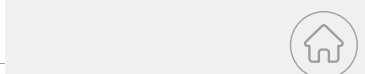

-  | GALLERY >
-  | STORAGES >
-  | FINISHES >
-  | UPHOLSTERY >



Timeless and sophisticated, Asmara collection will add a bright decorative accent and precious storage space to any home. Its minimalist structure is highlighted and embellished by the linear base, that gives it the lightness, and by the solid wood profile, which frames drawers and underlines the importance and preciousness of brass handles, giving a charm that has no age to these pieces.

**Top and structure finishes:** matt and glossy lacquer in the Galimberti Nino colour range / natural walnut / honey walnut / matt and glossy tobacco walnut / moro walnut  
**Lolita handles finishes:** bronze painted / satin brass

 | [VIEW ON WEBSITE](#) >

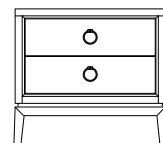

**ASM 88H**  
Night table >

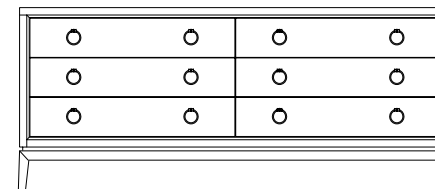

**ASM 87G**  
Chest of 6 drawers >

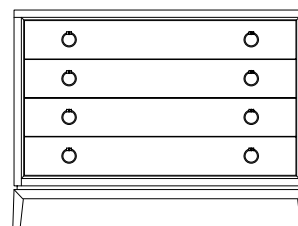



**ASM 86F**  
Chest of 4 drawers >



 | [GALLERY](#) >

 | [NIGHT STORAGES](#) >

 | [FINISHES](#) >

 | [UPHOLSTERY](#) >

Night table

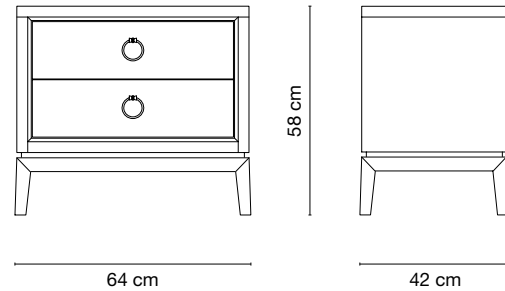

### TECHNICAL FEATURES

**Top, structure and drawers' frontal:** honeycomb MDF, MDF and chipboard panels /

honeycomb MDF, plywood and chipboard panels covered with walnut wood veneer

**Drawers' structure:** birch plywood / drawer runners with Blumotion technology

**Base and profiles:** toulipier massive wood / solid walnut

**Lolita handles:** brass

**Protective glides:** felt

Packaging	assembled	cbm.	kg.
Standard	●	0,28	33
Pallet	●	0,34	*
Wooden crate	●	0,48	*

\* weight to be confirmed

ASM 88H	Matt lacquered				Glossy lacquered				Matt walnut				Glossy walnut
	M001 M002 M003 M004 M005 M014	M006 M007 M011 M012 M013 M015 M018 M019	G001 G002 G003 G004 G005 G014	G006 G007 G011 G012 G013 G015 G018 G019	Natural Walnut NO.020.NA	Honey Walnut NO.020.MI	Tobacco Walnut NO.020.TA	Moro Walnut NO.020.MO	Tobacco Walnut NO.100.TA				
	●	●	●	●	●	●	●	●	●				



-  | GALLERY >
-  | NIGHT STORAGES >
-  | FINISHES >
-  | UPHOLSTERY >



Chest of 6 drawers

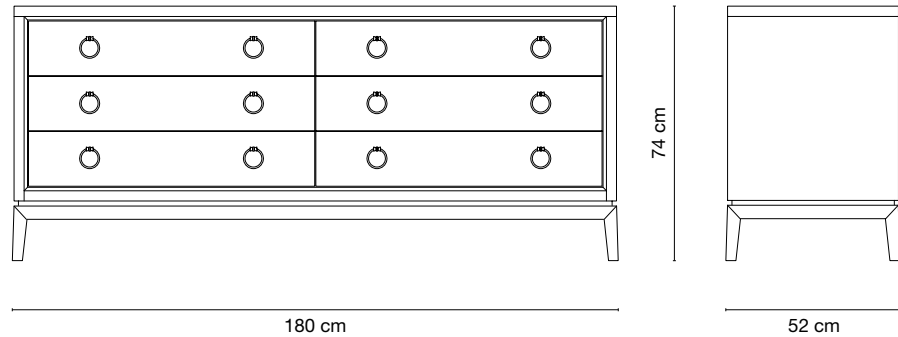

### TECHNICAL FEATURES

**Top, structure and drawers' frontal:** honeycomb MDF, MDF and chipboard panels /

honeycomb MDF, plywood and chipboard panels covered with walnut wood veneer

**Drawers' structure:** birch plywood / drawer runners with Blumotion technology

**Base and profiles:** toulipier massive wood / solid walnut

**Lolita handles:** brass

**Protective glides:** felt

Packaging	assembled	cbm.	kg.
Standard	●	0,98	109
Pallet	●	1,14	*
Wooden crate	●	1,48	*

\* weight to be confirmed

ASM 87G	Matt lacquered				Glossy lacquered				Matt walnut				Glossy walnut
	M001 M002 M003 M004 M005 M014	M006 M007 M011 M012 M013 M015 M018 M019	G001 G002 G003 G004 G005 G014	G006 G007 G011 G012 G013 G015 G018 G019	Natural Walnut NO.020.NA	Honey Walnut NO.020.MI	Tobacco Walnut NO.020.TA	Moro Walnut NO.020.MO	Tobacco Walnut NO.100.TA				
	●	●	●	●	●	●	●	●	●				



| GALLERY >

| NIGHT STORAGES >

| FINISHES >

| UPHOLSTERY >

Chest of 4 drawers

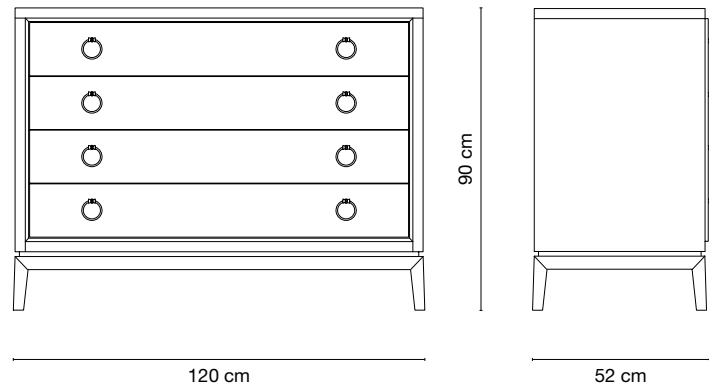

### TECHNICAL FEATURES

**Top, structure and drawers' frontal:** honeycomb MDF, MDF and chipboard panels /

honeycomb MDF, plywood and chipboard panels covered with walnut wood veneer

**Drawers' structure:** birch plywood / drawer runners with Blumotion technology

**Base and profiles:** toulipier massive wood / solid walnut

**Lolita handles:** brass

**Protective glides:** felt

Packaging	assembled	cbm.	kg.
Standard	●	0,76	84
Pallet	●	0,88	*
Wooden crate	●	1,14	*

\* weight to be confirmed

ASM 86F	Matt lacquered				Glossy lacquered				Matt walnut				Glossy walnut
	M001 M002 M003 M004 M005 M014	M006 M007 M011 M012 M013 M015 M018 M019	G001 G002 G003 G004 G005 G014	G006 G007 G011 G012 G013 G015 G018 G019	Natural Walnut NO.020.NA	Honey Walnut NO.020.MI	Tobacco Walnut NO.020.TA	Moro Walnut NO.020.MO	Tobacco Walnut NO.100.TA				
	●	●	●	●	●	●	●	●	●				



| GALLERY >

| NIGHT STORAGES >

| FINISHES >

| UPHOLSTERY >

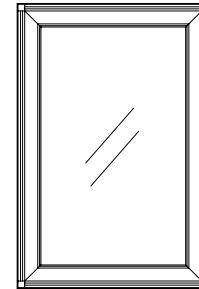

**AST 10A**  
Wall mirror



The simple silhouette of this mirror and its refined frame create a timeless, iconic piece that is a staple in any home. Either positioned in a modern entryway or a traditional bedroom, the essential lines and pure geometric proportions of this piece will add subtle elegance to any decor.

**Structure finishes:** matt and glossy lacquer in the Galimberti Nino colour range

 | [VIEW ON WEBSITE](#) >

 | [GALLERY](#) >

 | [COMPLEMENTARY FURNITURE](#) >

 | [FINISHES](#) >

 | [UPHOLSTERY](#) >

**ASTRID** | Studio Galimberti - 2017

Wall mirror

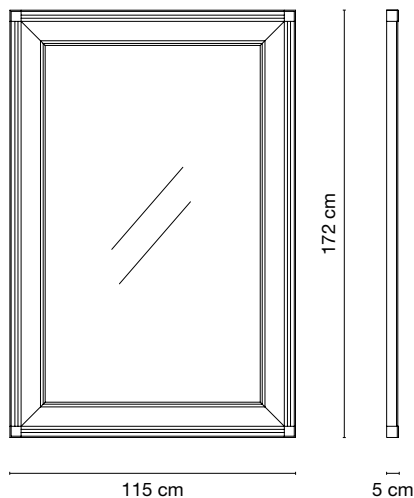

**TECHNICAL FEATURES**

**Structure:** solid beech wood and MDF panels





**Glass:** clear mirror glass 4 mm thick

Packaging	assembled	cbm.	kg.
Standard	●	0,35	34
Wooden crate	●	0,68	*

\* weight to be confirmed

AST 10A	Matt lacquered				Glossy lacquered			
	M001 M002 M003 M004 M005 M014	M006 M007 M011 M012 M013 M015 M018 M019	G001 G002 G003 G004 G005 G014	G006 G007 G011 G012 G013 G015 G018 G019				
	●	●	●	●				



-  | GALLERY >
-  | COMPLEMENTARY FURNITURE >
-  | FINISHES >
-  | UPHOLSTERY >

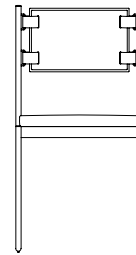



**BIR 33B**  
Dining chair

Leather and a sophisticated design combine in this exquisite chair that will be an ideal companion for a dining table in a loft or for a writing desk in a modern office. The structure in metal boasts sculptural details that create a rigorous frame for the seat and backrest.

**Covers:** leather  
**Structure finishes:** matt black

 | [VIEW ON WEBSITE](#) >

 | [GALLERY](#) >

 | [CHAIRS](#) >

 | [FINISHES](#) >

 | [UPHOLSTERY](#) >

Dining chair

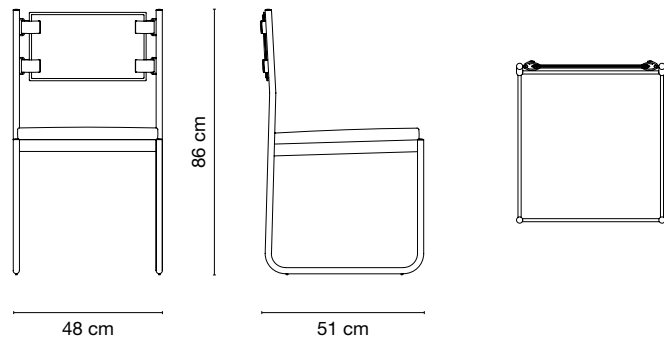

**TECHNICAL FEATURES**

**Structure:** painted metal  
**Seat and backrest:** plywood panels / padding in variable density high-resistance foam polyurethane / non-removable cover  
**Protective glides:** soft non-scratch rubber

Packaging	assembled 1pc	cbm.	kg.	assembled 2pc	cbm.	kg.
Standard	●	0,28	11	●	0,34	19
Pallet	●	0,32	*	●	0,38	*
Wooden crate	●	0,48	*	●	0,56	*

*\* weight to be confirmed*

BIR 33B	Metal	
	Matt Black ME.NER.20	
Leather	●	
Leather Lux	●	

- | GALLERY >
- | CHAIRS >
- | FINISHES >
- | UPHOLSTERY >

## BRIGITTA | Studio Galimberti - 2010



A precious addition to a living room or a study, this armchair is a superb object of functional decor. An ideal piece to lounge with a good book or to enjoy the company of friends and family after dinner, this armchair features a stunning combination of comfort and elegant design.

**Covers:** fabric / leather

**Structure finishes:** white ash wood / tobacco ash wood / moro ash wood / ebonized ash wood

 | [VIEW ON WEBSITE](#) >

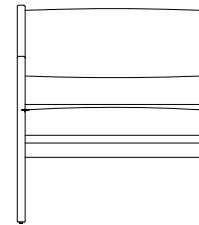



**BRI 91A**  
Armchair >



 | [GALLERY](#) >

 | [ARMCHAIRS AND OTTOMANS](#) >

 | [FINISHES](#) >

 | [UPHOLSTERY](#) >

## BRIGITTA | Studio Galimberti - 2010

Armchair

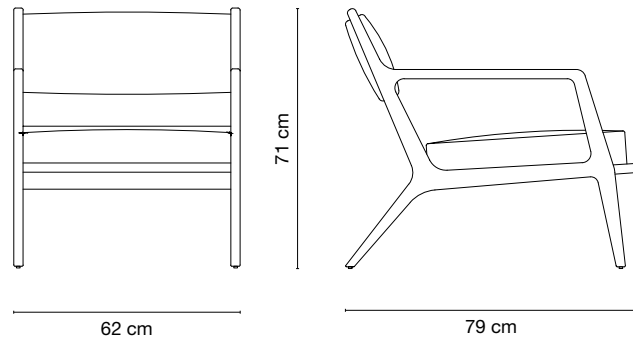
**TECHNICAL FEATURES****Structure:** solid ash wood**Seat and backrest:** plywood panel / padding in variable density high-resistance foam polyurethane / non-removable cover**Protective glides:** felt

Packaging	assembled	cbm.	kg.
Standard	●	0,48	16
Pallet	●	0,58	*
Wooden crate	●	0,78	*

\* weight to be confirmed

BRI 91A	Ash wood			
	White FR.020.BI	Tobacco FR.020.TA	Moro FR.020.MO	Ebonized FR.020.EB
Customer's fabric mtl. 1,00	●	●	●	●
Fabric cat. A	●	●	●	●
Fabric cat. B	●	●	●	●
Fabric cat. C	●	●	●	●
Fabric cat. D	●	●	●	●
Leather	●	●	●	●
Leather Lux	●	●	●	●



| GALLERY &gt;

| ARMCHAIRS AND OTTOMANS &gt;

| FINISHES &gt;

| UPHOLSTERY &gt;





This comfortable elegant armchair boasts a timeless design that will be equally stunning in a classic or contemporary home. It combines slender legs in brass with an enveloping and sinuous silhouette that includes a generous and cozy seat.

**Covers:** fabric

**Legs finishes:** bronze painted / satin brass

 | [VIEW ON WEBSITE](#) >

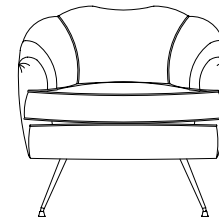

**CAM 01A**  
Armchair >

 | [GALLERY](#) >

 | [ARMCHAIRS AND OTTOMANS](#) >

 | [FINISHES](#) >

 | [UPHOLSTERY](#) >

# CAMELIA | Studio Galimberti - 2015

Armchair

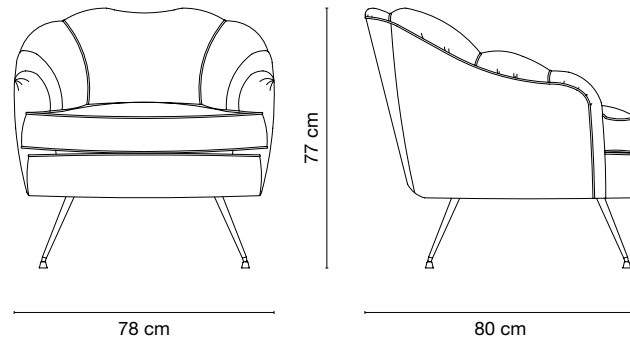

## TECHNICAL FEATURES

**Structure:** solid wood and plywood panels

**Seat and backrest:** padding in variable density high-resistance foam polyurethane / seat with elastic straps / non-removable cover

**Cushion:** goose down divided into sections with high-resistance foam polyurethane inset / removable cover

**Legs:** brass

**Piping:** gros grain

**Protective glides:** soft non-scratch rubber

Packaging	assembled	cbm.	kg.	not assembled	cbm.	kg.
Standard	●	0,62	27	●	0,48	27
Pallet	●	0,72	*	●	0,58	*
Wooden crate	●	0,96	*	●	0,78	*

\* weight to be confirmed

CAM 01A	Brass	
	Bronze finish ME.BRO.20	Satin ME.OTT.20
Customer's fabric mtl. 5,00	●	●
Fabric cat. A	●	●
Fabric cat. B	●	●
Fabric cat. C	●	●
Fabric cat. D	●	●



| GALLERY >

| ARMCHAIRS AND OTTOMANS >

| FINISHES >

| UPHOLSTERY >

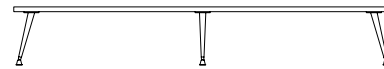

**CAM 02B**  
Coffee table 150x140

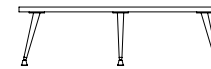



**CAM 03C**  
Coffee table Ø80

These sleek and sophisticated coffee tables are a refined choice for a modern or contemporary interior, where their timeless color combination and complementing finishes will create a harmonious effect.

**Top finishes:** matt and glossy lacquer in the Galimberti Nino colour range  
**Legs finishes:** bronze painted / satin brass

 | [VIEW ON WEBSITE](#) >

 | [GALLERY](#) >

 | [COFFEE AND SIDE TABLES](#) >

 | [FINISHES](#) >

 | [UPHOLSTERY](#) >

## CAMELIA | Studio Galimberti - 2015

Coffee table 150x140

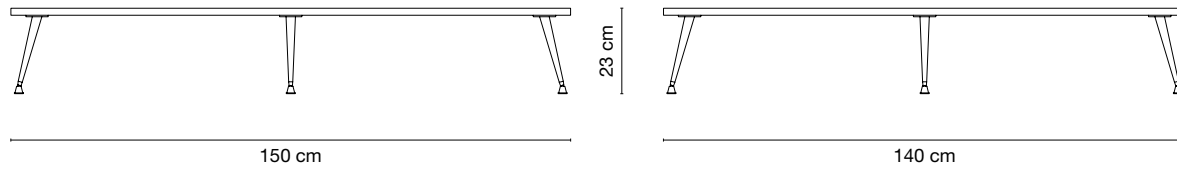

### TECHNICAL FEATURES

**Top:** MDF panel

**Legs:** brass

**Protective glides:** soft non-scratch rubber

Packaging	not assembled	cbm.	kg.
Standard	•	•	•

CAM 02B	Matt lacquered				Glossy lacquered			
	M001 M002 M003 M004 M005 M014	M006 M007 M011 M012 M013 M015 M018 M019	G001 G002 G003 G004 G005 G014	G006 G007 G011 G012 G013 G015 G018 G019				
	•	•	•	•				



| GALLERY >

| COFFEE AND SIDE TABLES >

| FINISHES >

| UPHOLSTERY >

## CAMELIA | Studio Galimberti - 2015

Coffee table Ø80

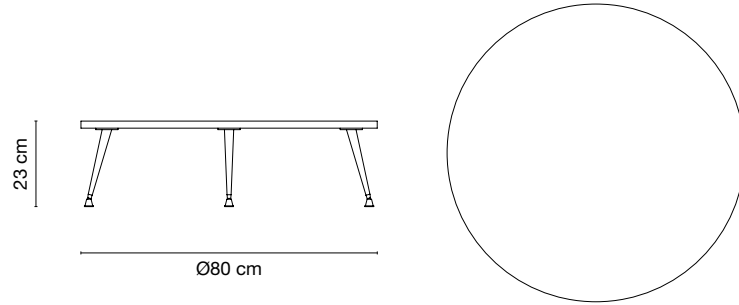

### TECHNICAL FEATURES

**Top:** MDF panel

**Legs:** brass

**Protective glides:** soft non-scratch rubber

Packaging	not assembled	cbm.	kg.
Standard	•	•	•

CAM 03C	Matt lacquered				Glossy lacquered			
	M001 M002 M003 M004 M005 M014	M006 M007 M011 M012 M013 M015 M018 M019	G001 G002 G003 G004 G005 G014	G006 G007 G011 G012 G013 G015 G018 G019				
	•	•	•	•				



| GALLERY >

| COFFEE AND SIDE TABLES >

| FINISHES >

| UPHOLSTERY >



The unique and refined silhouette of Charli coffee table make it the expression of the craftsmanship essence. Three minimalist legs, enriched by sumptuous brass ferrules, sustain a wonderful corolla and a thin glass top, whose transparency opens the vision of the wonderful support construction. In an entryway, living room or bedroom, its presence will be a touch of unique and inimitable style.

**Glass top finishes:** bronze

**Structure and legs finishes:** natural walnut / honey walnut / tobacco walnut / more walnut

**Legs' ferrules finishes:** bronze painted / satin brass

 | [VIEW ON WEBSITE](#) >

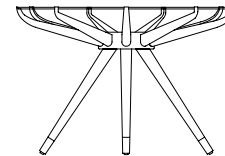

**CHA 26B**  
Side table >

 | [GALLERY](#) >

 | [COFFEE AND SIDE TABLES](#) >

 | [FINISHES](#) >

 | [UPHOLSTERY](#) >

Side table

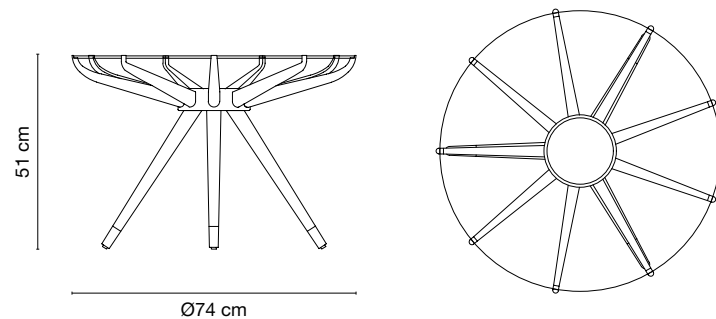

### TECHNICAL FEATURES

**Top:** 5 mm thick tempered glass

**Structure:** solid walnut and MDF panel covered with walnut wood veneer inset

**Legs:** solid walnut

**Legs ferrules:** brass

**Protective glides:** felt

Packaging	not assembled	cbm.	kg.
Standard	●	0,20	17
Wooden crate	●	0,42	*

\* weight to be confirmed

CHA 26B	Matt walnut			
	Natural Walnut NO.020.NA	Honey Walnut NO.020.MI	Tobacco Walnut NO.020.TA	Moro Walnut NO.020.MO
	●	●	●	●



| GALLERY >

| COFFEE AND SIDE TABLES >

| FINISHES >

| UPHOLSTERY >

## COLETTE | Studio Galimberti - 2019

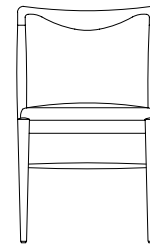

**COL 23B**  
Dining chair

The Colette chair simple yet elegant, made of linear pieces that boast exquisite craftsmanship and fine materials. Its gentle curves envelop the body in a comfortable hug. A perfect chair for a contemporary decor, this piece will add a note of sophistication to any dining or living room.

**Covers:** fabric / leather

**Structure finishes:** natural walnut / honey walnut / matt and glossy tobacco walnut / moro walnut

 | [VIEW ON WEBSITE](#) >

 | [GALLERY](#) >

 | [CHAIRS](#) >

 | [FINISHES](#) >

 | [UPHOLSTERY](#) >



# COLETTE | Studio Galimberti - 2019

Dining chair

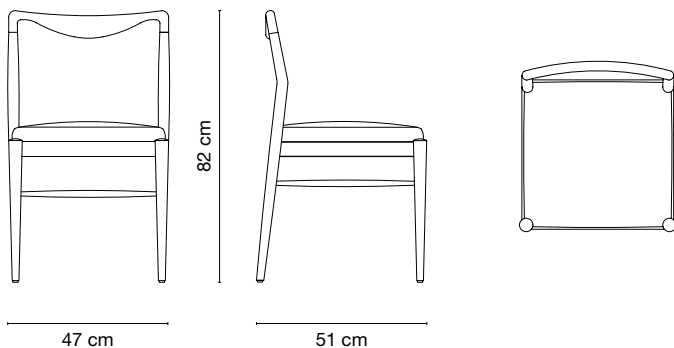

## TECHNICAL FEATURES

**Structure:** solid walnut

**Seat:** plywood panel / padding in variable density high-resistance foam polyurethane / non-removable cover

**Protective glides:** felt

Packaging	assembled 1pc	cbm.	kg.	assembled 2pc	cbm.	kg.
Standard	●	0,28	7	●	0,36	12
Pallet	●	0,32	*	●	0,42	*
Wooden crate	●	0,48	*	●	0,58	*

\* weight to be confirmed

COL 23B	Matt walnut				Glossy walnut	
	Natural Walnut NO.020.NA	Honey Walnut NO.020.MI	Tobacco Walnut NO.020.TA	Moro Walnut NO.020.MO	Tobacco Walnut NO.100.TA	
Customer's fabric mtl. 0,60	●	●	●	●	●	
Fabric cat. A	●	●	●	●	●	
Fabric cat. B	●	●	●	●	●	
Fabric cat. C	●	●	●	●	●	
Fabric cat. D	●	●	●	●	●	
Leather	●	●	●	●	●	
Leather Lux	●	●	●	●	●	



| GALLERY >

| CHAIRS >

| FINISHES >

| UPHOLSTERY >

## CORALLO | Studio Galimberti - 2014



The Corallo tables stand out for the surprising curved silhouette of the legs, reminiscent of the tulip flower shape, and for the presence of the precious metal details that create a delicate contrast of color and material. These tables are a wonderful addition to a modern or classic home, where they will be of strong visual impact both as a decorative piece in an entrance hall and as a dining table.

**Tops and structure finishes:** matt and glossy lacquer in the Galimberti Nino colour range  
**Metal finishes:** bronze painted / satin brass

 | [VIEW ON WEBSITE](#) >

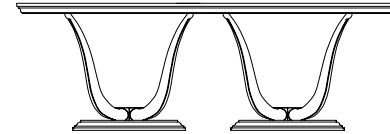

**COR 24E**  
Dining table 240x110 >

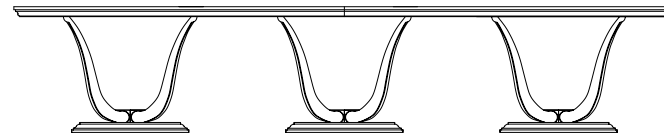

**COR 61A**  
Dining table 400x120 >

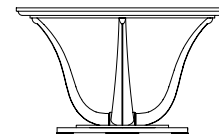

**COR 62B**  
Dining table Ø130 >

 | [GALLERY](#) >

 | [DINING TABLES](#) >

 | [FINISHES](#) >

 | [UPHOLSTERY](#) >

**CORALLO** | Studio Galimberti - 2014

Dining table 240x110

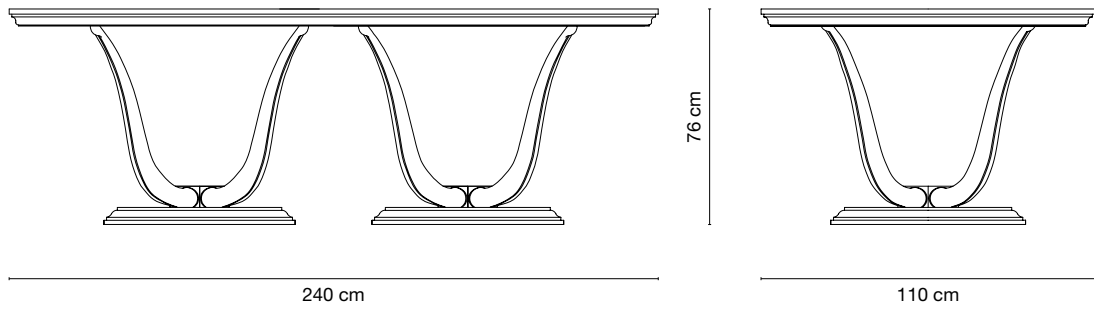





**TECHNICAL FEATURES**

**Top:** MDF panel and toulipier massive wood  
**Legs:** toulipier massive wood  
**Bases:** toulipier massive wood and MDF panel  
**Metal insets:** brass  
**Protective glides:** felt

Packaging	not assembled	cbm.	kg.
Standard	●	2,20	110
Pallet**	●	2,52	*
Wooden crate	●	3,52	*

\* weight to be confirmed \*\* top not included

COR 24E	Matt lacquered				Glossy lacquered			
	M001 M002 M003 M004 M005 M014	M006 M007 M011 M012 M013 M015 M018 M019	G001 G002 G003 G004 G005 G014	G006 G007 G011 G012 G013 G015 G018 G019				
	●	●	●	●				

-  | GALLERY >
-  | DINING TABLES >
-  | FINISHES >
-  | UPHOLSTERY >

**CORALLO** | Studio Galimberti - 2014

Dining table 400x120

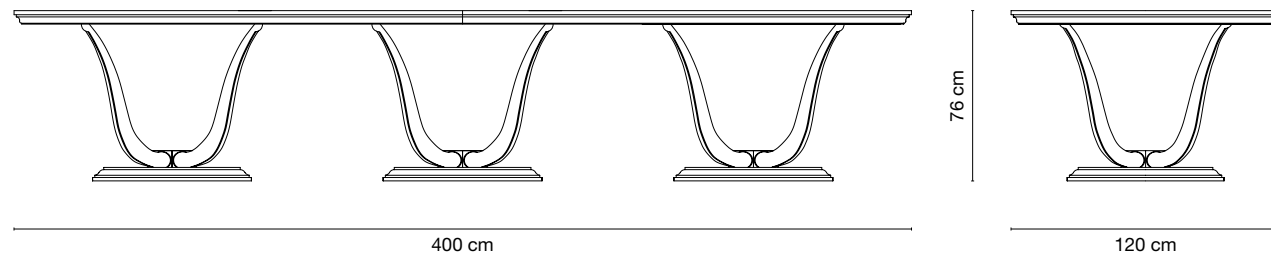

**TECHNICAL FEATURES**

**Top:** MDF panel and toulipier massive wood

**Legs:** toulipier massive wood

**Bases:** toulipier massive wood and MDF panel





**Metal insets:** brass

**Protective glides:** felt

Packaging	not assembled	cbm.	kg.
Standard	●	3,16	177
Pallet**	●	3,64	*
Wooden crate	●	4,90	*

\* weight to be confirmed \*\* top not included

COR 61A	Matt lacquered				Glossy lacquered			
	M001 M002 M003 M004 M005 M014	M006 M007 M011 M012 M013 M015 M018 M019	G001 G002 G003 G004 G005 G014	G006 G007 G011 G012 G013 G015 G018 G019				
	●	●	●	●				

-  | GALLERY >
-  | DINING TABLES >
-  | FINISHES >
-  | UPHOLSTERY >

**CORALLO** | Studio Galimberti - 2014

Dining table Ø130

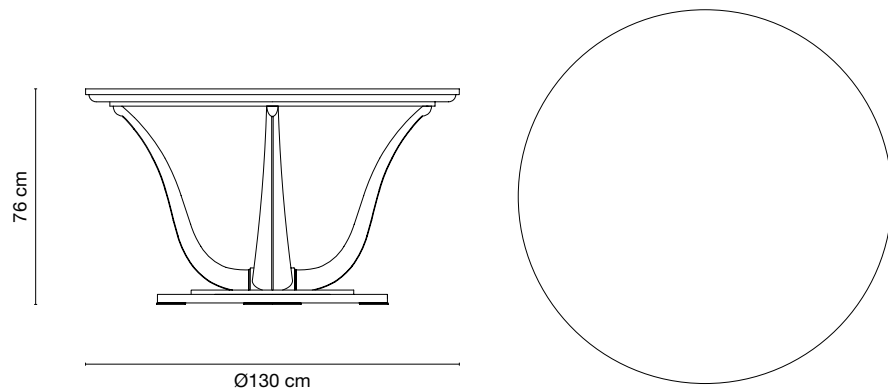

**TECHNICAL FEATURES**

**Top:** MDF panel and toulipier massive wood

**Legs:** toulipier massive wood

**Base:** toulipier massive wood and MDF panel

**Metal insets:** brass

**Protective glides:** felt

Packaging	not assembled	cbm.	kg.
Standard	●	1,02	60
Pallet**	●	1,14	*
Wooden crate	●	1,70	*

\* weight to be confirmed \*\* top not included

COR 62B	Matt lacquered				Glossy lacquered			
	M001 M002 M003 M004 M005 M014	M006 M007 M011 M012 M013 M015 M018 M019	G001 G002 G003 G004 G005 G014	G006 G007 G011 G012 G013 G015 G018 G019				
	●	●	●	●				



| GALLERY >

| DINING TABLES >

| FINISHES >

| UPHOLSTERY >

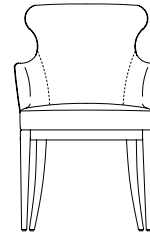

**DIL 31B**  
Dining arm chair

A surprising series of curves distinguish the elegant and sinuous design of this chair. Around a dining table or behind a classic desk, this piece will give a touch of refined and timeless elegance to both a classic and contemporary interior. The perfectly proportioned wooden base beautifully contrasts with the soft curves that characterize the seat and backrest.

**Covers:** fabric / leather

**Base finishes:** matt and glossy lacquer in the Galimberti Nino colour range / natural walnut / honey walnut / matt and glossy tobacco walnut / moro walnut

 | [VIEW ON WEBSITE](#) >

 | [GALLERY](#) >

 | [CHAIRS](#) >

 | [FINISHES](#) >

 | [UPHOLSTERY](#) >

# DILETTA

 | Studio Galimberti - 2020

Dining arm chair

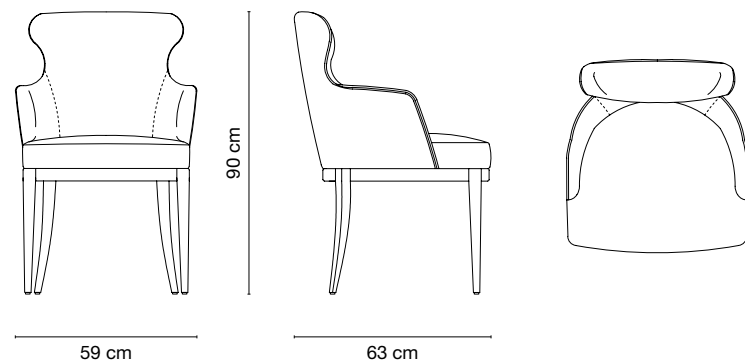
**TECHNICAL FEATURES****Structure:** solid beech wood / solid walnut**Seat and backrest:** plywood panels / padding in variable density high-resistance foam polyurethane / non-removable cover**Piping:** gros grain**Protective glides:** felt

Packaging	assembled	cbm.	kg.
Standard	●	0,36	14
Pallet	●	0,42	*
Wooden crate	●	0,60	*

\* weight to be confirmed

DIL 31B	Matt lacquered				Glossy lacquered				Matt walnut				Glossy walnut
	M001 M002 M003 M004 M005 M014	M006 M007 M011 M012 M013 M015 M018 M019	G001 G002 G003 G004 G005 G014	G006 G007 G011 G012 G013 G015 G018 G019	Natural Walnut NO.020.NA	Honey Walnut NO.020.MI	Tobacco Walnut NO.020.TA	Moro Walnut NO.020.MO	Tobacco Walnut NO.100.TA				
Customer's fabric mtl. 2,00	●	●	●	●	●	●	●	●	●				
Fabric cat. A	●	●	●	●	●	●	●	●	●				
Fabric cat. B	●	●	●	●	●	●	●	●	●				
Fabric cat. C	●	●	●	●	●	●	●	●	●				
Fabric cat. D	●	●	●	●	●	●	●	●	●				
Leather	●	●	●	●	●	●	●	●	●				
Leather Lux	●	●	●	●	●	●	●	●	●				

| GALLERY &gt;

| CHAIRS &gt;

| FINISHES &gt;

| UPHOLSTERY &gt;

**DOLCEVITA** | Studio Galimberti - 2009



The minimal and at the same time functional aesthetic defines this exquisite collection of storages that fits perfectly in both a modern and classic ambience, thanks to its simple but elegant design. Its important structure with soft and rounded lines is lightened thanks to the slender legs with an unmistakable style. Evoking the elegance of classic décor, these pieces feature precious brass Art Deco handles with buffalo horn inserts.

**Tops and structure finishes:** white ash wood / tobacco ash wood / moro ash wood / ebonized ash wood

**Decò handles finishes:** satin brass with buffalo's horn inset

 | [VIEW ON WEBSITE](#) >

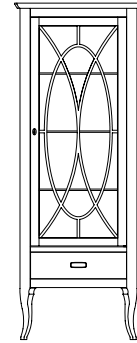

**DOV 09L**  
1 door showcase >

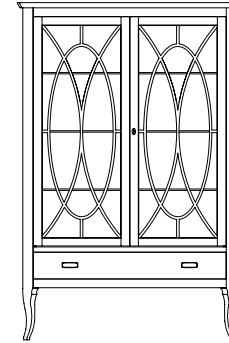

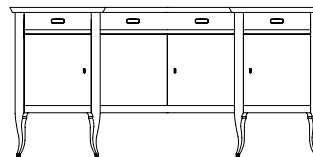

**DOV 08H**  
2 doors showcase >





**DOV 10M**  
Sideboard >



 | [GALLERY](#) >

 | [STORAGES](#) >

 | [FINISHES](#) >

 | [UPHOLSTERY](#) >



**DOLCEVITA** | Studio Galimberti - 2009

1 door showcase

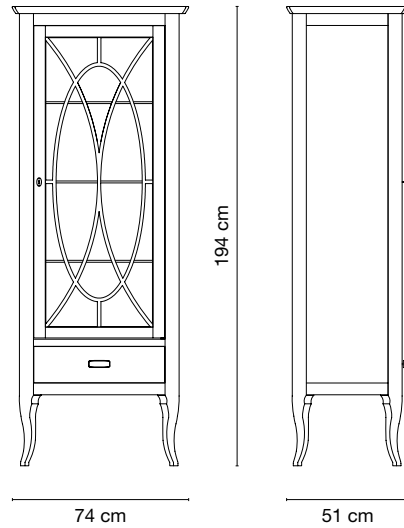

**TECHNICAL FEATURES**

**Top:** chipboard panel covered with ash wood veneer and solid ash wood frame  
**Structure and drawer:** solid ash wood and plywood, MDF and chipboard panels covered with ash wood veneer / drawer runners with Blumotion technology  
**Door:** solid ash wood frame and MDF panel covered with ash wood veneer / transparent glass 4 mm thick  
**Legs:** solid ash wood  
**Protective glides:** felt

Packaging	assembled	cbm.	kg.
Standard	●	0,92	95
Pallet	●	0,98	*
Wooden crate	●	1,32	*

\* weight to be confirmed

DOV 09L	Ash wood			
	White FR.020.BI	Tobacco FR.020.TA	Moro FR.020.MO	Ebonized FR.020.EB
	●	●	●	●



| GALLERY >

| STORAGES >

| FINISHES >

| UPHOLSTERY >

**DOLCEVITA** | Studio Galimberti - 2009

2 doors showcase

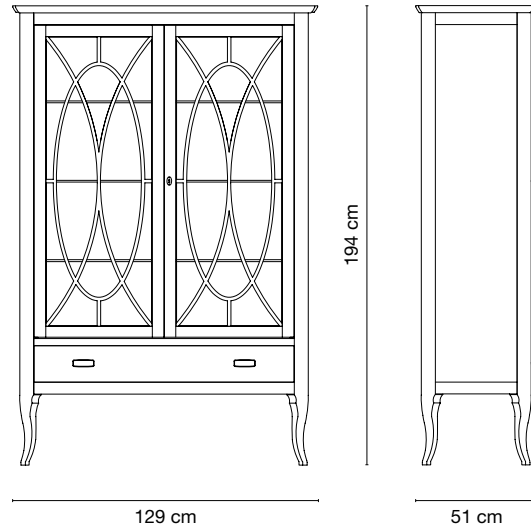

**TECHNICAL FEATURES**





**Top:** chipboard panel covered with ash wood veneer and solid ash wood frame  
**Structure and drawers:** solid ash wood and plywood, MDF and chipboard panels covered with ash wood veneer / drawer runners with Blumotion technology  
**Doors:** solid ash wood frame and MDF panel covered with ash wood veneer / transparent glass 4 mm thick  
**Legs:** solid ash wood  
**Protective glides:** felt

Packaging	assembled	cbm.	kg.
Standard	●	1,68	147
Pallet	●	1,80	*
Wooden crate	●	2,30	*

\* weight to be confirmed

DOV 08H	Ash wood			
	White FR.020.BI	Tobacco FR.020.TA	Moro FR.020.MO	Ebonized FR.020.EB
	●	●	●	●



-  | GALLERY >
-  | STORAGES >
-  | FINISHES >
-  | UPHOLSTERY >

# DOLCEVITA

 | Studio Galimberti - 2009

Sideboard

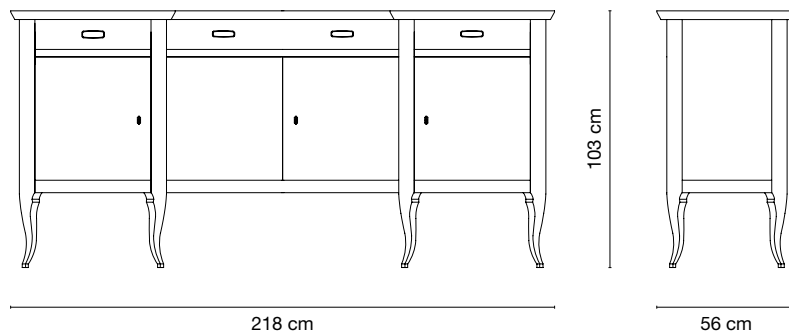
**TECHNICAL FEATURES**

**Top:** chipboard panel covered with ash wood veneer and solid ash wood frame

**Structure and drawers:** solid ash wood and plywood, MDF and chipboard panels covered with ash wood veneer / drawer runners with Blumotion technology

**Legs:** solid ash wood

**Protective glides:** felt

Packaging	assembled	cbm.	kg.
Standard	●	1,70	160
Pallet	●	1,92	*
Wooden crate	●	2,38	*

\* weight to be confirmed

DOV 10M	Ash wood			
	White FR.020.BI	Tobacco FR.020.TA	Moro FR.020.MO	Ebonized FR.020.EB
	●	●	●	●

[GALLERY](#) >

[STORAGES](#) >

[FINISHES](#) >

[UPHOLSTERY](#) >



The minimal and at the same time functional aesthetic defines this exquisite collection of night storages that fits perfectly in both a modern and classic ambience, thanks to its simple but elegant design. Its important structure with soft and rounded lines is lightened thanks to the slender legs with an unmistakable style. Evoking the elegance of classic décor, these pieces feature precious brass Art Deco handles with buffalo horn inserts.

**Tops and structure finishes:** white ash wood / tobacco ash wood / moro ash wood / ebonized ash wood

**Decò handles finishes:** satin brass with buffalo's horn inset

 | [VIEW ON WEBSITE](#) >



**DOV 12P**  
Night table >

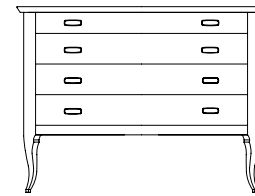



**DOV 11N**  
Chest of drawers >



 | [GALLERY](#) >

 | [NIGHT STORAGES](#) >

 | [FINISHES](#) >

 | [UPHOLSTERY](#) >

# DOLCEVITA | Studio Galimberti - 2009

Night table

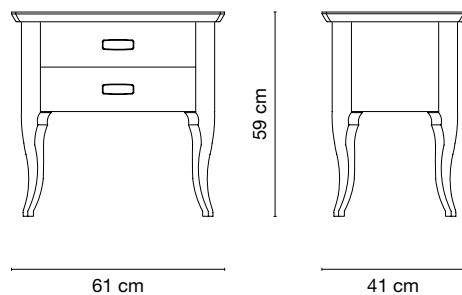

### TECHNICAL FEATURES

**Top:** chipboard panel covered with ash wood veneer and solid ash wood frame

**Structure and drawers:** solid ash wood and plywood, MDF and chipboard panels covered with ash wood veneer / drawer runners with Blumotion technology

**Legs:** solid ash wood

**Protective glides:** felt

Packaging	assembled	cbm.	kg.
Standard	●	0,22	24
Pallet	●	0,26	*
Wooden crate	●	0,40	*

\* weight to be confirmed

DOV 12P	Ash wood			
	White FR.020.BI	Tobacco FR.020.TA	Moro FR.020.MO	Ebonized FR.020.EB
	●	●	●	●



| GALLERY >

| NIGHT STORAGES >

| FINISHES >

| UPHOLSTERY >

# DOLCEVITA

 | Studio Galimberti - 2009

Chest of drawers

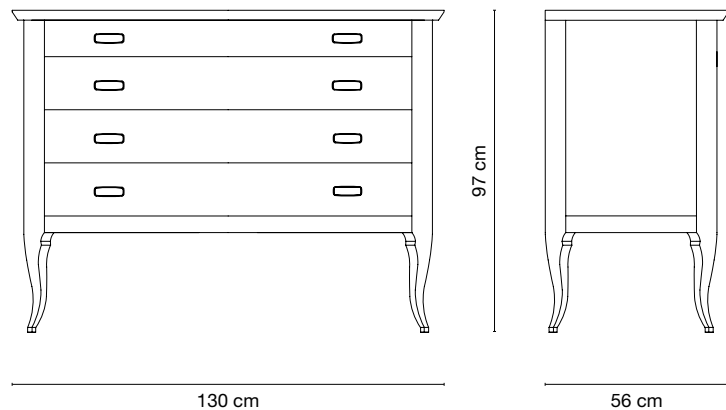
**TECHNICAL FEATURES**

**Top:** chipboard panel covered with ash wood veneer and solid ash wood frame

**Structure and drawers:** solid ash wood and plywood, MDF and chipboard panels covered with ash wood veneer / drawer runners with Blumotion technology

**Legs:** solid ash wood

**Protective glides:** felt

Packaging	assembled	cbm.	kg.
Standard	●	0,94	86
Pallet	●	1,06	*
Wooden crate	●	1,36	*

\* weight to be confirmed

DOV 11N	Ash wood			
	White FR.020.BI	Tobacco FR.020.TA	Moro FR.020.MO	Ebonized FR.020.EB
	●	●	●	●

[GALLERY](#) >

[NIGHT STORAGES](#) >

[FINISHES](#) >

[UPHOLSTERY](#) >



With their unique style that combines retro inspiration with a modern aesthetic, these benches offer a functional touch in both a modern and neo-classic interior. Placed in an entrance hall or in a bedroom, these pieces will be an expression of style, adding the charm to any ambience.

**Covers:** fabric / leather

**Structure finishes:** white ash wood / tobacco ash wood / moro ash wood / ebonized ash wood

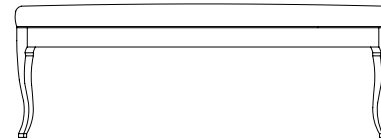

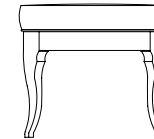

**DOV 02B**  
Bench >



**DOV 03C**  
Small bench >

 | [VIEW ON WEBSITE](#) >

 | [GALLERY](#) >

 | [ARMCHAIRS AND OTTOMANS](#) >

 | [FINISHES](#) >

 | [UPHOLSTERY](#) >

# DOLCEVITA | Studio Galimberti - 2009

Bench

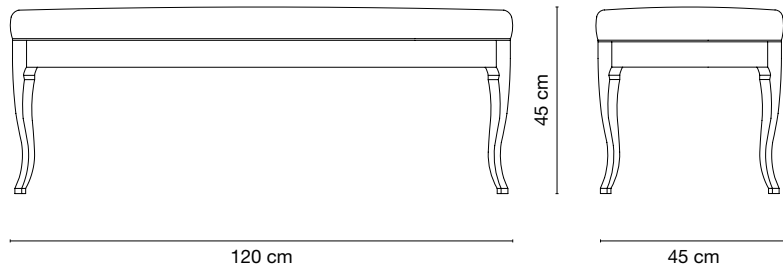

### TECHNICAL FEATURES

**Structure:** solid ash wood

**Seat:** plywood panel / padding in variable density high-resistance foam polyurethane / non-removable cover

**Piping:** gros grain

**Protective glides:** felt

Packaging	assembled	cbm.	kg.
Standard	●	0,40	16
Pallet	●	0,52	*
Wooden crate	●	0,70	*

\* weight to be confirmed

DOV 02B	Ash wood			
	White FR.020.BI	Tobacco FR.020.TA	Moro FR.020.MO	Ebonized FR.020.EB
Customer's fabric mtl. 1,30	●	●	●	●
Fabric cat. A	●	●	●	●
Fabric cat. B	●	●	●	●
Fabric cat. C	●	●	●	●
Fabric cat. D	●	●	●	●
Leather	●	●	●	●
Leather Lux	●	●	●	●

| GALLERY >

| ARMCHAIRS AND OTTOMANS >

| FINISHES >

| UPHOLSTERY >



# DOLCEVITA

 | Studio Galimberti - 2009

Small bench

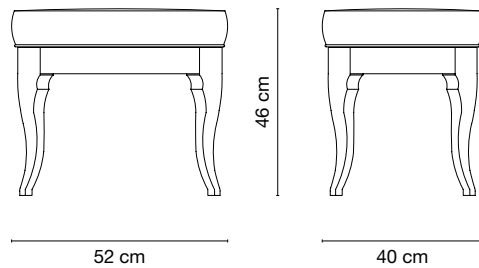
**TECHNICAL FEATURES****Structure:** solid ash wood**Seat:** plywood panel / padding in variable density high-resistance foam polyurethane / non-removable cover**Piping:** gros grain**Protective glides:** felt

Packaging	assembled	cbm.	kg.
Standard	●	0,14	9
Wooden crate	●	0,28	*

\* weight to be confirmed

DOV 03C	Ash wood			
	White FR.020.BI	Tobacco FR.020.TA	Moro FR.020.MO	Ebonized FR.020.EB
Customer's fabric mtl. 0,60	●	●	●	●
Fabric cat. A	●	●	●	●
Fabric cat. B	●	●	●	●
Fabric cat. C	●	●	●	●
Fabric cat. D	●	●	●	●
Leather	●	●	●	●
Leather Lux	●	●	●	●



| GALLERY &gt;

| ARMCHAIRS AND OTTOMANS &gt;

| FINISHES &gt;

| UPHOLSTERY &gt;

## DOLCEVITA | Studio Galimberti - 2009



This vanity desk, functional and refined, blends minimalist lines and mid century flair, so that its look is both compact and aesthetically seductive. The flip-top mirror and the storage compartment in the center of the top will be appreciated for their simplicity and practicality in everyday use. Evoking the elegance of classic décor, this item features precious Art Deco brass handles with buffalo horn inserts. This piece will complement any bedroom with a timeless elegance.

**Tops and structure finishes:** white ash wood / tobacco ash wood / moro ash wood / ebonized ash wood

**Decò handles finishes:** satin brass with buffalo's horn inset

 | [VIEW ON WEBSITE](#) >

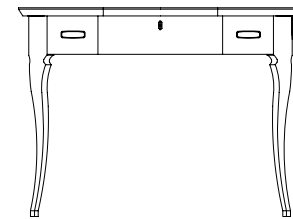

**DOV 07G**  
Vanity table >

 | [GALLERY](#) >

 | [VANITY TABLES](#) >

 | [FINISHES](#) >

 | [UPHOLSTERY](#) >

## DOLCEVITA | Studio Galimberti - 2009

Vanity table

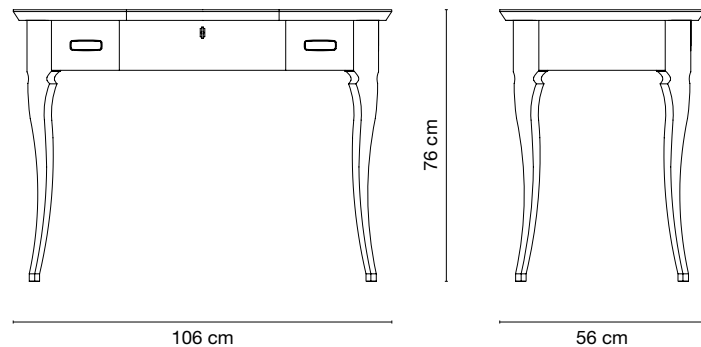
**TECHNICAL FEATURES****Top:** chipboard panel covered with ash wood veneer and solid ash wood frame**Structure and drawers:** solid ash wood and plywood, MDF and chipboard panels covered with ash wood veneer / drawer runners with Blumotion technology**Legs:** solid ash wood**Protective glides:** felt

Packaging	assembled	cbm.	kg.
Standard	●	0,64	50
Pallet	●	0,76	*
Wooden crate	●	1,00	*

\* weight to be confirmed

DOV 07G	Ash wood			
	White FR.020.BI	Tobacco FR.020.TA	Moro FR.020.MO	Ebonized FR.020.EB
	●	●	●	●

[GALLERY](#) >

[VANITY TABLES](#) >

[FINISHES](#) >

[UPHOLSTERY](#) >

DOLCEVITA | Studio Galimberti - 2009



Evoking the elegance of classic furniture, this dining table with its simple yet chic design will elevate the style of any interior decor. A harmonious balance of sculptural aesthetic and functionality, the table, crafted with utmost attention to the details, will fit both modern and more classic, mid-century interiors.

**Tops and structure finishes:** white ash wood / tobacco ash wood / more ash wood / ebonized ash wood

 | [VIEW ON WEBSITE](#) >



**DOV 01A**  
Extendable dining table >

 | [GALLERY](#) >

 | [DINING TABLES](#) >

 | [FINISHES](#) >

 | [UPHOLSTERY](#) >

# DOLCEVITA

 | Studio Galimberti - 2009

Extendable dining table

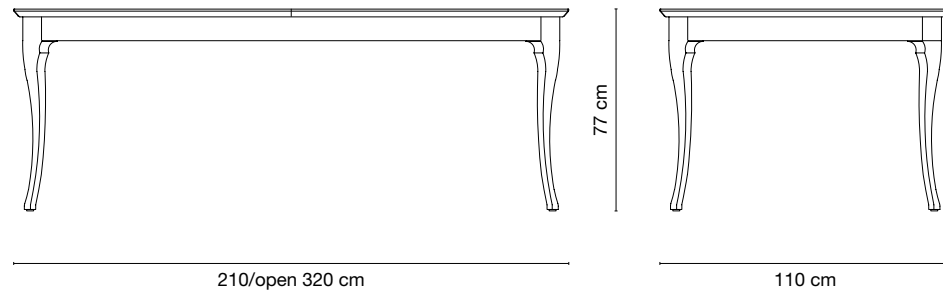
**TECHNICAL FEATURES****Top:** chipboard panels covered with ash wood veneer and solid ash wood frame**Structure and legs:** solid ash wood**Extension mechanism:** aluminum sliding guides**Protective glides:** felt

Packaging	assembled	cbm.	kg.
Standard	●	0,58	92
Wooden crate	●	1,14	*

\* weight to be confirmed

DOV 01A	Ash wood			
	White FR.020.BI	Tobacco FR.020.TA	Moro FR.020.MO	Ebonized FR.020.EB
	●	●	●	●



| GALLERY &gt;

| DINING TABLES &gt;

| FINISHES &gt;

| UPHOLSTERY &gt;



The simple and austere lines of these coffee and side tables inspired by the 50s of the last century, convey a visual lightness that will revive both modern and classic living rooms. Their structure with soft and rounded lines is lightened thanks to the slender legs with an unmistakable style. Testimony of traditional craftsmanship, their elegant shape will create a functional support surface in every room of the house.

**Tops and structure finishes:** white ash wood / tobacco ash wood / moro ash wood / ebonized ash wood

 | [VIEW ON WEBSITE](#) >

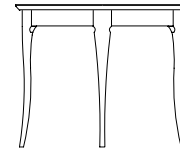

**DOV 04D**  
Side table >

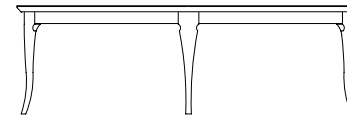

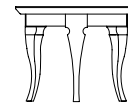

**DOV 05E**  
Oval coffee table >



**DOV 06F**  
Low coffee table >

 | [GALLERY](#) >

 | [COFFEE AND SIDE TABLES](#) >

 | [FINISHES](#) >

 | [UPHOLSTERY](#) >

# DOLCEVITA | Studio Galimberti - 2009

Side table

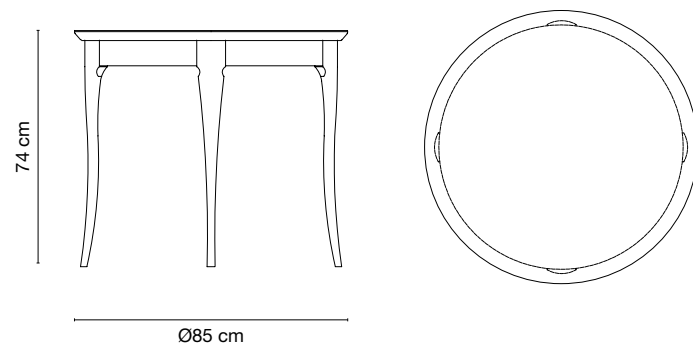

### TECHNICAL FEATURES

**Top:** chipboard panel covered with ash wood veneer and solid ash wood frame

**Structure and legs:** solid ash wood

**Protective glides:** felt

Packaging	assembled	cbm.	kg.
Standard	●	0,66	24
Pallet	●	0,78	*
Wooden crate	●	1,00	*

\* weight to be confirmed

DOV 04D	Ash wood			
	White FR.020.BI	Tobacco FR.020.TA	Moro FR.020.MO	Ebonized FR.020.EB
	●	●	●	●



| GALLERY >

| COFFEE AND SIDE TABLES >

| FINISHES >

| UPHOLSTERY >

# DOLCEVITA | Studio Galimberti - 2009

Oval coffee table

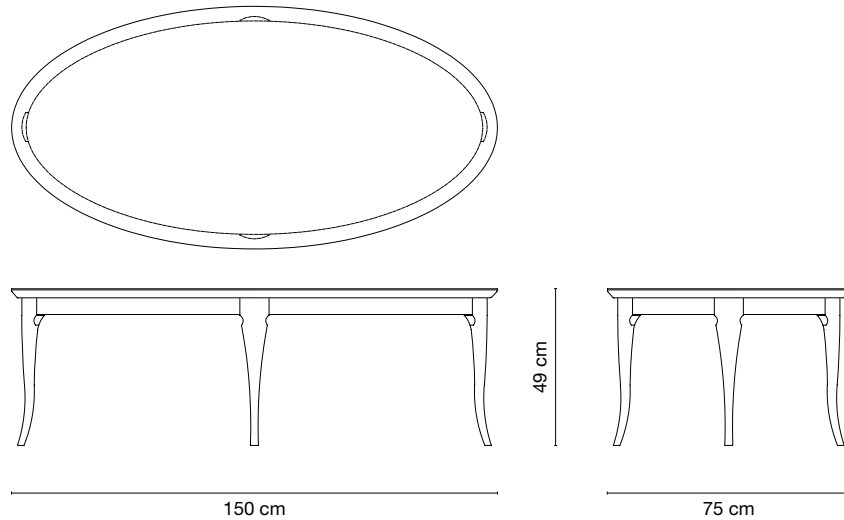

### TECHNICAL FEATURES

**Top:** chipboard panel covered with ash wood veneer and solid ash wood frame

**Structure and legs:** solid ash wood

**Protective glides:** felt

Packaging	assembled	cbm.	kg.
Standard	●	0,70	31
Pallet	●	0,88	*
Wooden crate	●	1,12	*

\* weight to be confirmed

DOV 05E	Ash wood			
	White FR.020.BI	Tobacco FR.020.TA	Moro FR.020.MO	Ebonized FR.020.EB
	●	●	●	●

| GALLERY >

| COFFEE AND SIDE TABLES >

| FINISHES >

| UPHOLSTERY >



# DOLCEVITA

 | Studio Galimberti - 2009

Low coffee table

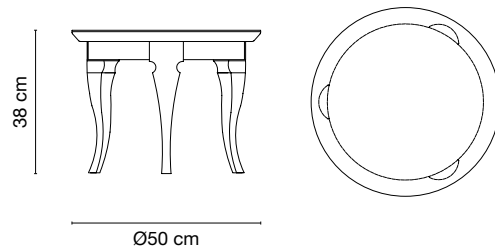
**TECHNICAL FEATURES****Top:** chipboard panel covered with ash wood veneer and solid ash wood frame**Structure and legs:** solid ash wood**Protective glides:** felt

Packaging	assembled	cbm.	kg.
Standard	●	0,14	7
Wooden crate	●	0,28	*

\* weight to be confirmed

DOV 06F	Ash wood			
	White FR.020.BI	Tobacco FR.020.TA	Moro FR.020.MO	Ebonized FR.020.EB
	●	●	●	●



| GALLERY &gt;

| COFFEE AND SIDE TABLES &gt;

| FINISHES &gt;

| UPHOLSTERY &gt;



This elegant sofa will add a sophisticated retro vibe to any classic or modern living room while providing comfortable seating combined with stunning decorative quality. The padded structure, the delicately curved armrests and the soft lines are highlighted with the use of a wooden base with a slight visual impact.

**Covers:** fabric

**Base finishes:** matt and glossy lacquer in the Galimberti Nino colour range

 | [VIEW ON WEBSITE](#) >

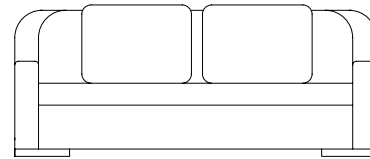

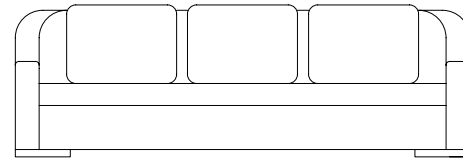

**EDM 12B**  
Sofa 198 >



**EDM 11A**  
Sofa 248 >

 | [GALLERY](#) >

 | [SOFAS](#) >

 | [FINISHES](#) >

 | [UPHOLSTERY](#) >

# EDMOND | Studio Galimberti - 2017

Sofa 198

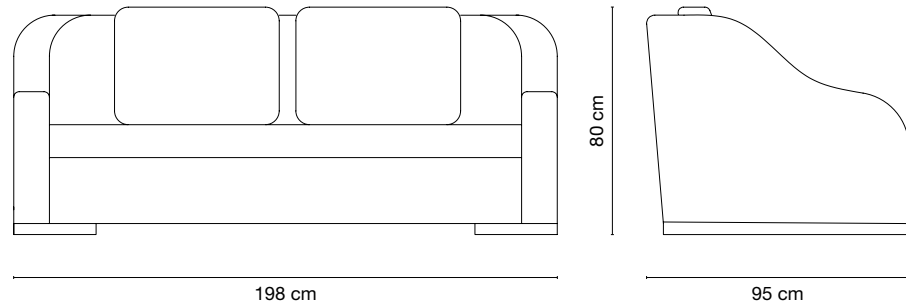

### TECHNICAL FEATURES

**Structure:** solid wood and plywood panels

**Seat and backrest:** padding in variable density high-resistance foam polyurethane / seat with elastic straps / non-removable cover

**Cushions:** goose down divided into sections with high-resistance foam polyurethane inset / removable cover

**Legs:** solid beech wood

**Piping:** gros grain

**Protective glides:** felt

Packaging	assembled	cbm.	kg.
Standard	●	1,94	87
Pallet	●	2,28	*
Wooden crate	●	2,72	*

\* weight to be confirmed

EDM 12B	Matt lacquered				Glossy lacquered			
	M001 M002 M003 M004 M005 M014	M006 M007 M011 M012 M013 M015 M018 M019	G001 G002 G003 G004 G005 G014	G006 G007 G011 G012 G013 G015 G018 G019				
Customer's fabric mtl. 15,00	●	●	●	●				
Fabric cat. A	●	●	●	●				
Fabric cat. B	●	●	●	●				
Fabric cat. C	●	●	●	●				
Fabric cat. D	●	●	●	●				



| GALLERY >

| SOFAS >

| FINISHES >

| UPHOLSTERY >

# EDMOND

 | Studio Galimberti - 2017

Sofa 248

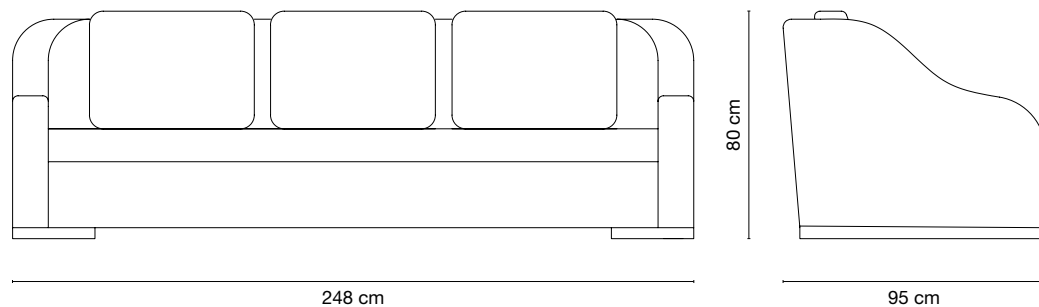
**TECHNICAL FEATURES****Structure:** solid wood and plywood panels**Seat and backrest:** padding in variable density high-resistance foam polyurethane / seat with elastic straps / non-removable cover**Cushions:** goose down divided into sections with high-resistance foam polyurethane inset / removable cover**Legs:** solid beech wood**Piping:** gros grain**Protective glides:** felt

Packaging	assembled	cbm.	kg.
Standard	●	2,42	116
Pallet	●	2,82	*
Wooden crate	●	3,36	*

\* weight to be confirmed

EDM 11A	Matt lacquered				Glossy lacquered			
	M001 M002 M003 M004 M005 M014	M006 M007 M011 M012 M013 M015 M018 M019	G001 G002 G003 G004 G005 G014	G006 G007 G011 G012 G013 G015 G018 G019				
Customer's fabric mtl. 16,50	●	●	●	●				
Fabric cat. A	●	●	●	●				
Fabric cat. B	●	●	●	●				
Fabric cat. C	●	●	●	●				
Fabric cat. D	●	●	●	●				

| GALLERY &gt;

| SOFAS &gt;

| FINISHES &gt;

| UPHOLSTERY &gt;



The perfection of Egle chair and bar stool proportions is reflected in the successful combination of the back with its delicate and sinuous curves, expression of a soft embrace, with the base in precious solid wood in which the smoothness of the finish beautifully contrasts with the bright and luxurious presence of brass details. A unique piece with a personality strong enough to impress its character in any environment, both classic and modern.

**Covers:** fabric / leather

**Base finishes:** matt and glossy lacquer in the Galimberti Nino colour range / natural walnut / honey walnut / matt and glossy tobacco walnut / moro walnut

**Metal finishes:** satin brass

 | [VIEW ON WEBSITE](#) >

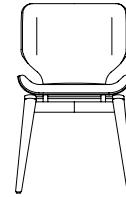

**EGL 14B**  
Dinig chair >

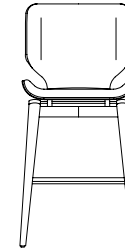

**EGL 62P**  
High backrest bar stool >

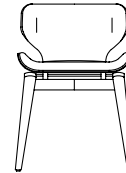

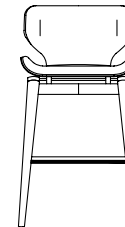

**EGL 25C**  
Chair >



**EGL 51H**  
Bar stool >

 | [GALLERY](#) >

 | [CHAIRS](#) >

 | [FINISHES](#) >

 | [UPHOLSTERY](#) >

Dining chair

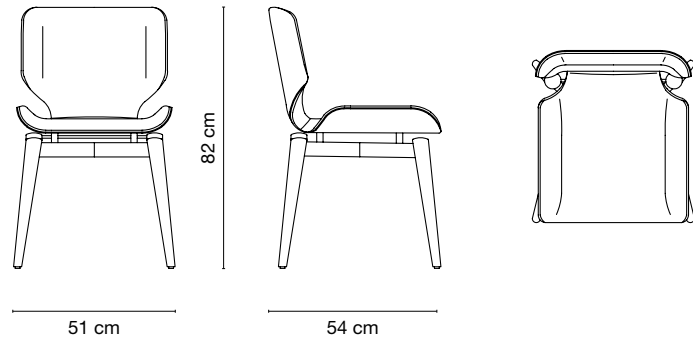
**TECHNICAL FEATURES****Structure:** solid beech wood / solid walnut**Seat and backrest:** plywood panel / padding in variable density high-resistance foam polyurethane / non-removable cover**Piping:** gros grain**Metal:** brass**Protective glides:** felt

Packaging	assembled	cbm.	kg.
Standard	●	0,30	11
Pallet	●	0,36	*
Wooden crate	●	0,52	*

\* weight to be confirmed

EGL 14B	Matt lacquered				Glossy lacquered				Matt walnut				Glossy walnut
	M001 M002 M003 M004 M005 M014	M006 M007 M011 M012 M013 M015 M018 M019	G001 G002 G003 G004 G005 G014	G006 G007 G011 G012 G013 G015 G018 G019	Natural Walnut NO.020.NA	Honey Walnut NO.020.MI	Tobacco Walnut NO.020.TA	Moro Walnut NO.020.MO	Tobacco Walnut NO.100.TA				
Customer's fabric mtl. 1,10	●	●	●	●	●	●	●	●	●				
Fabric cat. A	●	●	●	●	●	●	●	●	●				
Fabric cat. B	●	●	●	●	●	●	●	●	●				
Fabric cat. C	●	●	●	●	●	●	●	●	●				
Fabric cat. D	●	●	●	●	●	●	●	●	●				
Leather	●	●	●	●	●	●	●	●	●				
Leather Lux	●	●	●	●	●	●	●	●	●				

| GALLERY &gt;

| CHAIRS &gt;

| FINISHES &gt;

| UPHOLSTERY &gt;

## High backrest bar stool

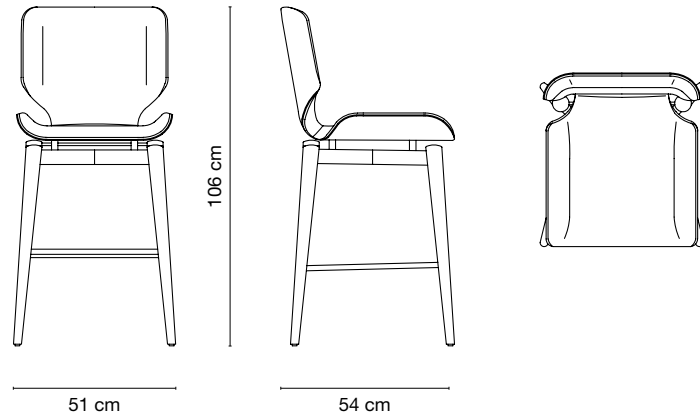
**TECHNICAL FEATURES****Structure:** solid beech wood / solid walnut**Seat and backrest:** plywood panel / padding in variable density high-resistance foam polyurethane / non-removable cover**Piping:** gros grain**Metal:** brass**Protective glides:** felt

Packaging	assembled	cbm.	kg.
Standard	●	0,38	12
Pallet	●	0,42	*
Wooden crate	●	0,60	*

\* weight to be confirmed

EGL 62P	Matt lacquered				Glossy lacquered				Matt walnut				Glossy walnut
	M001 M002 M003 M004 M005 M014	M006 M007 M011 M012 M013 M015 M018 M019	G001 G002 G003 G004 G005 G014	G006 G007 G011 G012 G013 G015 G018 G019	Natural Walnut NO.020.NA	Honey Walnut NO.020.MI	Tobacco Walnut NO.020.TA	Moro Walnut NO.020.MO	Tobacco Walnut NO.100.TA				
Customer's fabric mtl. 1,10	●	●	●	●	●	●	●	●	●				
Fabric cat. A	●	●	●	●	●	●	●	●	●				
Fabric cat. B	●	●	●	●	●	●	●	●	●				
Fabric cat. C	●	●	●	●	●	●	●	●	●				
Fabric cat. D	●	●	●	●	●	●	●	●	●				
Leather	●	●	●	●	●	●	●	●	●				
Leather Lux	●	●	●	●	●	●	●	●	●				

| GALLERY &gt;

| CHAIRS &gt;

| FINISHES &gt;

| UPHOLSTERY &gt;

## Chair

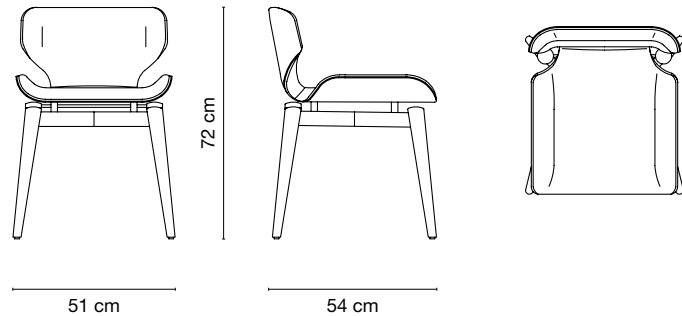
**TECHNICAL FEATURES****Structure:** solid beech wood / solid walnut**Seat and backrest:** plywood panel / padding in variable density high-resistance foam polyurethane / non-removable cover**Piping:** gros grain**Metal:** brass**Protective glides:** felt

Packaging	assembled	cbm.	kg.
Standard	●	0,28	10
Pallet	●	0,32	*
Wooden crate	●	0,46	*

\* weight to be confirmed

EGL 25C	Matt lacquered				Glossy lacquered				Matt walnut				Glossy walnut
	M001 M002 M003 M004 M005 M014	M006 M007 M011 M012 M013 M015 M018 M019	G001 G002 G003 G004 G005 G014	G006 G007 G011 G012 G013 G015 G018 G019	Natural Walnut NO.020.NA	Honey Walnut NO.020.MI	Tobacco Walnut NO.020.TA	Moro Walnut NO.020.MO	Tobacco Walnut NO.100.TA				
Customer's fabric mtl. 1,10	●	●	●	●	●	●	●	●	●				
Fabric cat. A	●	●	●	●	●	●	●	●	●				
Fabric cat. B	●	●	●	●	●	●	●	●	●				
Fabric cat. C	●	●	●	●	●	●	●	●	●				
Fabric cat. D	●	●	●	●	●	●	●	●	●				
Leather	●	●	●	●	●	●	●	●	●				
Leather Lux	●	●	●	●	●	●	●	●	●				

| GALLERY &gt;

| CHAIRS &gt;

| FINISHES &gt;

| UPHOLSTERY &gt;



## Bar stool

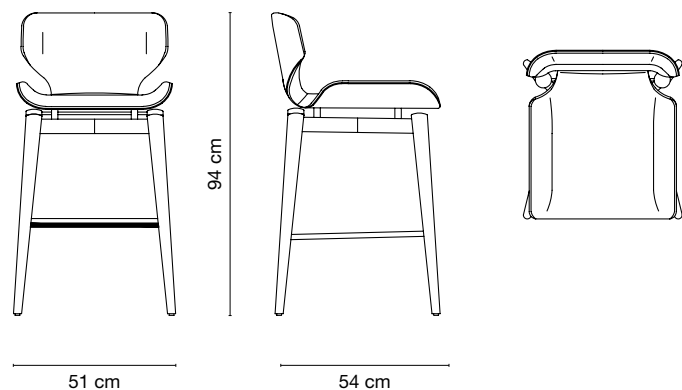

## TECHNICAL FEATURES

**Structure:** solid beech wood / solid walnut

**Seat and backrest:** plywood panel / padding in variable density high-resistance foam polyurethane / non-removable cover

**Piping:** gros grain

**Metal:** brass

**Protective glides:** felt

Packaging	assembled	cbm.	kg.
Standard	●	0,34	11
Pallet	●	0,38	*
Wooden crate	●	0,56	*

\* weight to be confirmed

EGL 51H	Matt lacquered				Glossy lacquered				Matt walnut				Glossy walnut
	M001 M002 M003 M004 M005 M014	M006 M007 M011 M012 M013 M015 M018 M019	G001 G002 G003 G004 G005 G014	G006 G007 G011 G012 G013 G015 G018 G019	Natural Walnut NO.020.NA	Honey Walnut NO.020.MI	Tobacco Walnut NO.020.TA	Moro Walnut NO.020.MO	Tobacco Walnut NO.100.TA				
Customer's fabric mtl. 1,10	●	●	●	●	●	●	●	●	●				
Fabric cat. A	●	●	●	●	●	●	●	●	●				
Fabric cat. B	●	●	●	●	●	●	●	●	●				
Fabric cat. C	●	●	●	●	●	●	●	●	●				
Fabric cat. D	●	●	●	●	●	●	●	●	●				
Leather	●	●	●	●	●	●	●	●	●				
Leather Lux	●	●	●	●	●	●	●	●	●				

| GALLERY >

| CHAIRS >

| FINISHES >

| UPHOLSTERY >

ELIODORO | Studio Galimberti - 2014

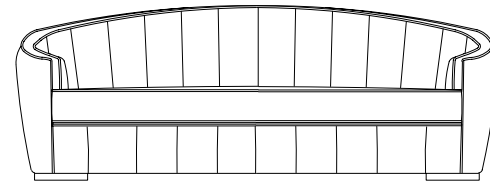

ELI 61A  
Sofa >

This charming sofa, inspired by the elegance of the Art Deco style, stands out with its vibrant classic shape in every ambience of the house. The curved backrest wraps around the seat and flows into the sloping armrests, creating a soft and inviting look, both timeless and comfortable. The metal-covered base adds a touch of luxury, light but significant, making this piece a refined addition to any interior, be it contemporary or traditional.

**Covers:** fabric

**Base finishes:** bronze painted / satin brass

 | [VIEW ON WEBSITE](#) >

 | [GALLERY](#) >

 | [SOFAS](#) >

 | [FINISHES](#) >

 | [UPHOLSTERY](#) >

## ELIODORO

Studio Galimberti - 2014

Sofa

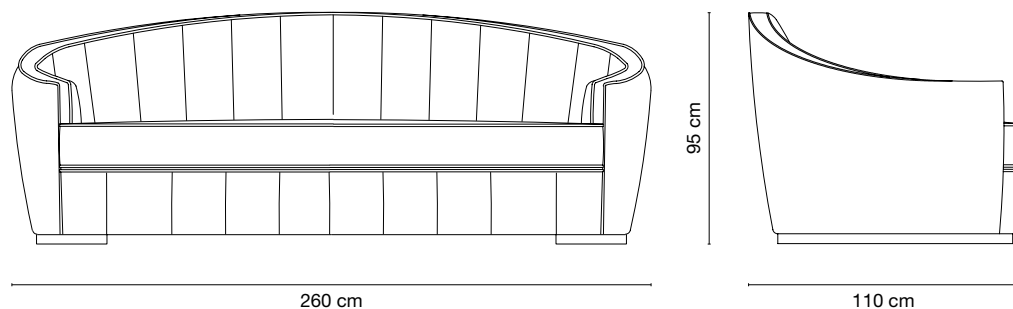
**TECHNICAL FEATURES****Structure:** solid wood and plywood panels**Seat and backrest:** padding in variable density high-resistance foam polyurethane / seat with elastic straps / non-removable cover**Cushion:** goose down divided into sections with high-resistance foam polyurethane inset / removable cover**Legs:** brass covered plywood panels**Piping:** gros grain**Protective glides:** felt

Packaging	assembled	cbm.	kg.
Standard	●	3,70	102
Pallet	●	4,22	*
Wooden crate	●	4,90	*

\* weight to be confirmed

ELI 61A	Brass	
	Bronze finish ME.BRO.20	Satin ME.OTT.20
Customer's fabric mtl. 15,00	●	●
Fabric cat. A	●	●
Fabric cat. B	●	●
Fabric cat. C	●	●
Fabric cat. D	●	●

 | GALLERY >

 | SOFAS >

 | FINISHES >

 | UPHOLSTERY >

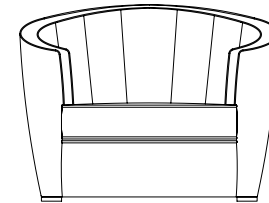

**ELI 62B**  
Armchair

This charming armchair, inspired by the elegance of the Art Deco style, stands out with its vibrant classic shape in every ambience of the house. The curved backrest wraps around the seat and flows into the sloping armrests, creating a soft and inviting look, both timeless and comfortable. The metal-covered base adds a touch of luxury, light but significant, making this piece a refined addition to any interior, be it contemporary or traditional.

**Covers:** fabric

**Base finishes:** bronze painted / satin brass

 | [VIEW ON WEBSITE](#) >

 | [GALLERY](#) >

 | [ARMCHAIRS AND OTTOMANS](#) >

 | [FINISHES](#) >

 | [UPHOLSTERY](#) >

# ELIODORO

 | Studio Galimberti - 2014

Armchair

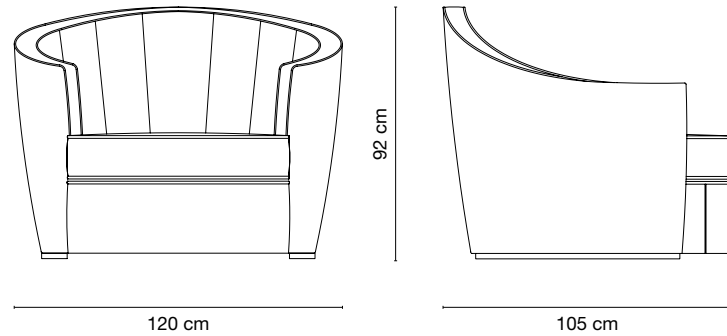
**TECHNICAL FEATURES****Structure:** solid wood and plywood panels**Seat and backrest:** padding in variable density high-resistance foam polyurethane / seat with elastic straps / non-removable cover**Cushion:** goose down divided into sections with high-resistance foam polyurethane inset / removable cover**Legs:** brass covered plywood panels**Piping:** gros grain**Protective glides:** felt

Packaging	assembled	cbm.	kg.
Standard	●	1,52	53
Pallet	●	1,74	*
Wooden crate	●	2,12	*

\* weight to be confirmed

ELI 62B	Brass	
	Bronze finish ME.BRO.20	Satin ME.OTT.20
Customer's fabric mtl. 9,50	●	●
Fabric cat. A	●	●
Fabric cat. B	●	●
Fabric cat. C	●	●
Fabric cat. D	●	●



| GALLERY &gt;

| ARMCHAIRS AND OTTOMANS &gt;

| FINISHES &gt;

| UPHOLSTERY &gt;



Focused on simplicity with a steady eye on style, this bed of Art Deco-inspired design is enriched with luxurious details to enliven a modern and classic bedroom. The wooden frame of the upholstered headboard and the wooden base of the padded structure create a play of contrasts and materials and add the luxury touch to this piece.

**Covers:** fabric / leather

**Structure finishes:** matt and glossy lacquer in the Galimberti Nino colour range

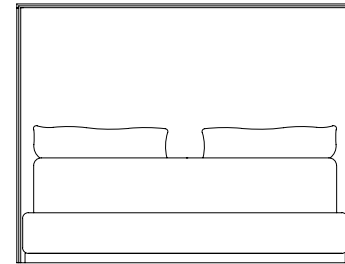

**ELL 16D**  
Bed 160

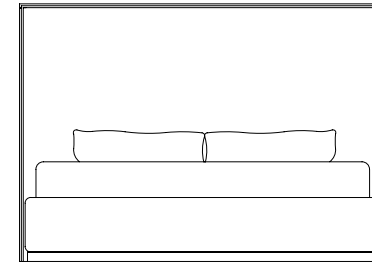

**ELL 31A**  
Bed 180

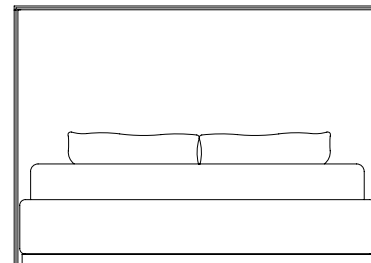

**ELL 33C**  
Storage bed 180

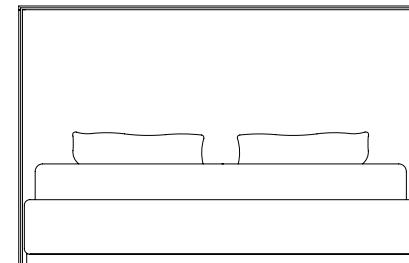

**ELL 32B**  
Bed 200



VIEW ON WEBSITE



GALLERY



BEDS



FINISHES



UPHOLSTERY

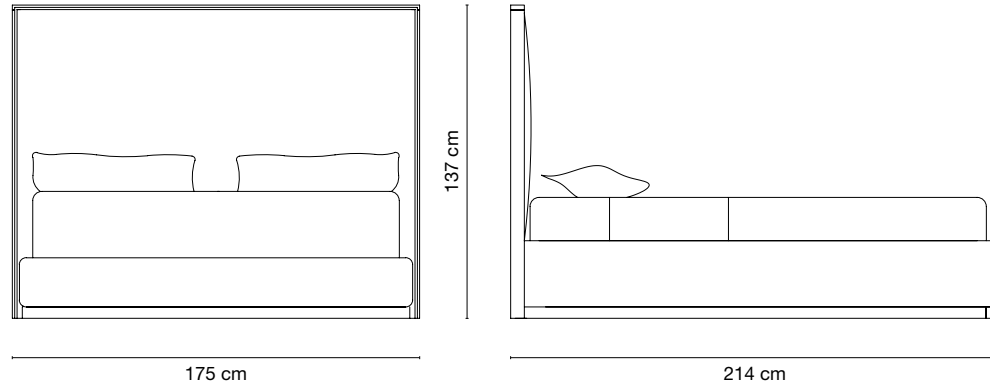

## Bed 160

**TECHNICAL FEATURES**

**Structure:** solid beech wood and plywood, honeycomb MDF and chipboard panels

**Headboard, footboard and sides:** padding in variable density high-resistance foam polyurethane / non-removable cover

**Piping:** gros grain

**Mattress' support:** metal bed frame with wooden slats

**Protective glides:** felt

**Mattress (not included):** size 160 x 200 x h.22 cm

Cushions and bed set not included

Packaging	not assembled	cbm.	kg.
Standard	●	0,94	107
Wooden crate**	●	1,66	*

\* weight to be confirmed \*\* slatted base not included

ELL 16D	Matt lacquered				Glossy lacquered			
	M001 M002 M003 M004 M005 M014	M006 M007 M011 M012 M013 M015 M018 M019	G001 G002 G003 G004 G005 G014	G006 G007 G011 G012 G013 G015 G018 G019				
Customer's fabric mtl. 5,50	●	●	●	●				
Fabric cat. A	●	●	●	●				
Fabric cat. B	●	●	●	●				
Fabric cat. C	●	●	●	●				
Fabric cat. D	●	●	●	●				
Leather	●	●	●	●				
Leather Lux	●	●	●	●				



| GALLERY >

| BEDS >

| FINISHES >

| UPHOLSTERY >

## Bed 180

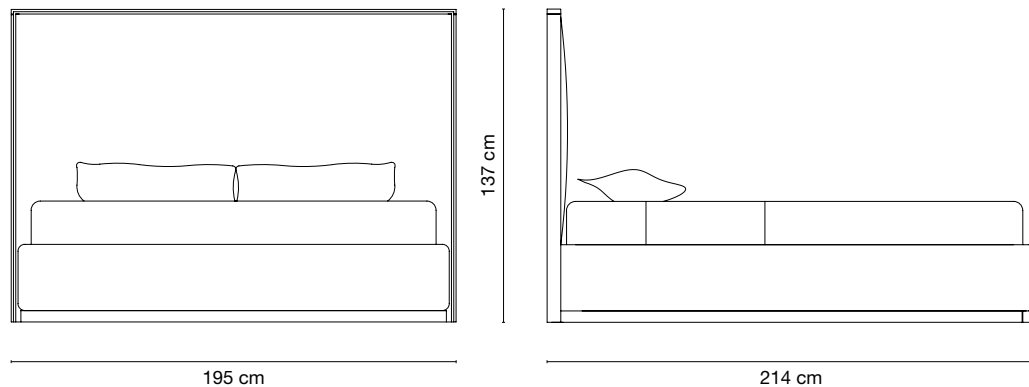
**TECHNICAL FEATURES**

**Structure:** solid beech wood and plywood, honeycomb MDF and chipboard panels

**Headboard, footboard and sides:** padding in variable density high-resistance foam polyurethane / non-removable cover

**Piping:** gros grain

**Mattress' support:** metal bed frame with wooden slats

**Protective glides:** felt

**Mattress (not included):** size 180 x 200 x h.22 cm

Cushions and bed set not included

Packaging	not assembled	cbm.	kg.
Standard	●	1,02	117
Wooden crate**	●	1,78	*

\* weight to be confirmed \*\* slatted base not included

ELL 31A	Matt lacquered				Glossy lacquered			
	M001 M002 M003 M004 M005 M014	M006 M007 M011 M012 M013 M015 M018 M019	G001 G002 G003 G004 G005 G014	G006 G007 G011 G012 G013 G015 G018 G019				
Customer's fabric mtl. 5,70	●	●	●	●				
Fabric cat. A	●	●	●	●				
Fabric cat. B	●	●	●	●				
Fabric cat. C	●	●	●	●				
Fabric cat. D	●	●	●	●				
Leather	●	●	●	●				
Leather Lux	●	●	●	●				



| GALLERY >

| BEDS >

| FINISHES >

| UPHOLSTERY >



## Storage bed 180

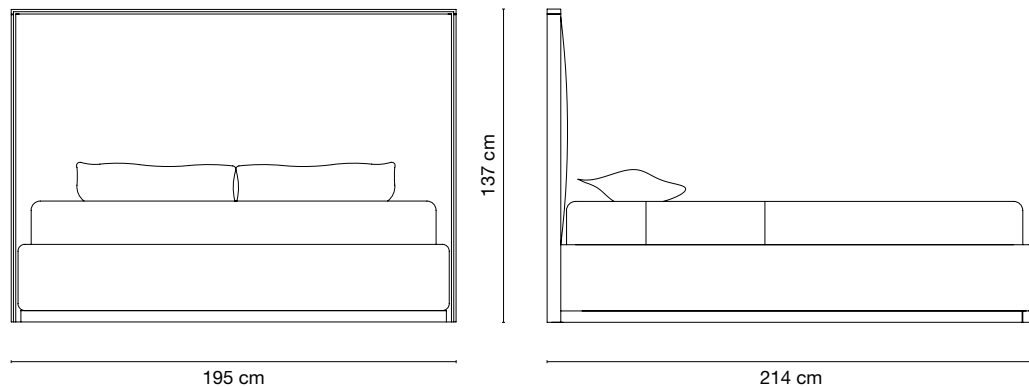

## TECHNICAL FEATURES

**Structure:** solid beech wood and plywood, honeycomb MDF and chipboard panels

**Headboard, footboard and sides:** padding in variable density high-resistance foam polyurethane / non-removable cover

**Piping:** gros grain

**Mattress' support:** metal bed frame with wooden slats and bed lift mechanism with full opening and horizontal stabilizer (mattress max. 45 kg)

**Protective glides:** felt

**Mattress (not included):** size 180 x 200 x h.22 cm

Cushions and bed set not included

Packaging	not assembled	cbm.	kg.
Standard	●	1,20	164
Wooden crate**	●	2,10	*

\* weight to be confirmed \*\* slatted base not included

ELL 33C	Matt lacquered				Glossy lacquered			
	M001 M002 M003 M004 M005 M014	M006 M007 M011 M012 M013 M015 M018 M019	G001 G002 G003 G004 G005 G014	G006 G007 G011 G012 G013 G015 G018 G019				
Customer's fabric mtl. 5,70	●	●	●	●				
Fabric cat. A	●	●	●	●				
Fabric cat. B	●	●	●	●				
Fabric cat. C	●	●	●	●				
Fabric cat. D	●	●	●	●				
Leather	●	●	●	●				
Leather Lux	●	●	●	●				



| GALLERY >

| BEDS >

| FINISHES >

| UPHOLSTERY >

Bed 200

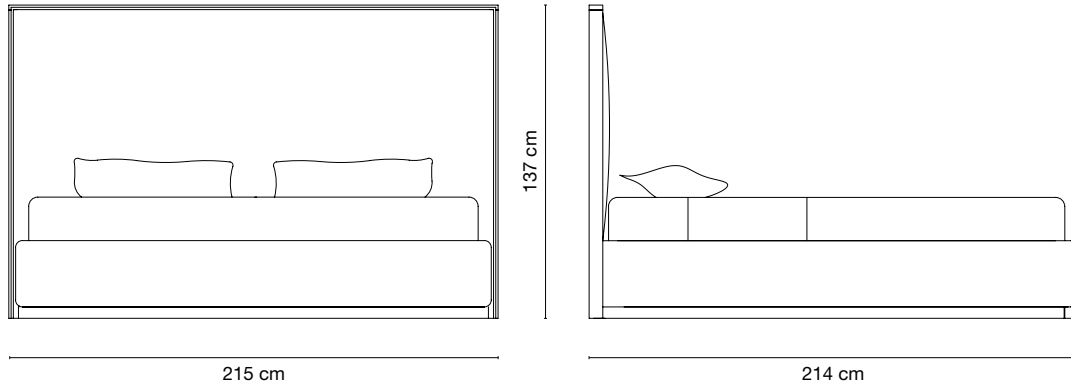
**TECHNICAL FEATURES****Structure:** solid beech wood and plywood, honeycomb MDF and chipboard panels**Headboard, footboard and sides:** padding in variable density high-resistance foam polyurethane / non-removable cover**Piping:** gros grain**Mattress' support:** metal bed frame with wooden slats**Protective glides:** felt**Mattress (not included):** size 200 x 200 x h.22 cm

Cushions and bed set not included

Packaging	not assembled	cbm.	kg.
Standard	●	1,08	133
Wooden crate**	●	1,88	*

\* weight to be confirmed \*\* slatted base not included

ELL 32B	Matt lacquered				Glossy lacquered			
	M001 M002 M003 M004 M005 M014	M006 M007 M011 M012 M013 M015 M018 M019	G001 G002 G003 G004 G005 G014	G006 G007 G011 G012 G013 G015 G018 G019				
Customer's fabric mtl. 6,10	●	●	●	●				
Fabric cat. A	●	●	●	●				
Fabric cat. B	●	●	●	●				
Fabric cat. C	●	●	●	●				
Fabric cat. D	●	●	●	●				
Leather	●	●	●	●				
Leather Lux	●	●	●	●				



| GALLERY &gt;

| BEDS &gt;

| FINISHES &gt;

| UPHOLSTERY &gt;



Focused on simplicity with a steady eye on style, this bed of Art Deco-inspired design is enriched with luxurious details to enliven a modern and classic bedroom. The wooden frame of the upholstered headboard and the wooden base of the padded structure create a play of contrasts and materials and add the luxury touch to this piece.

**Covers:** fabric

**Structure finishes:** matt and glossy lacquer in the Galimberti Nino colour range

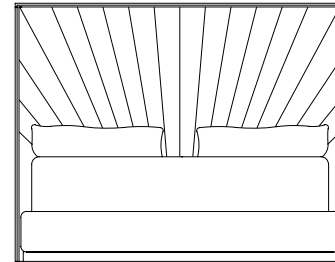

**ELD 16E**  
Bed 160

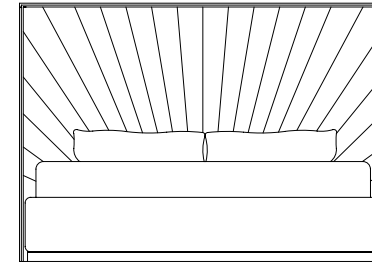

**ELD 51A**  
Bed 180

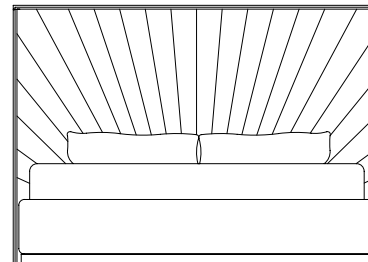

**ELD 53C**  
Storage bed 180

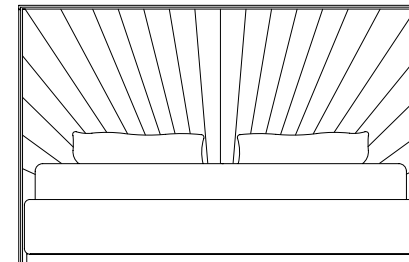



**ELD 52B**  
Bed 200



 | [VIEW ON WEBSITE](#) >

 | [GALLERY](#) >

 | [BEDS](#) >

 | [FINISHES](#) >

 | [UPHOLSTERY](#) >

## Bed 160

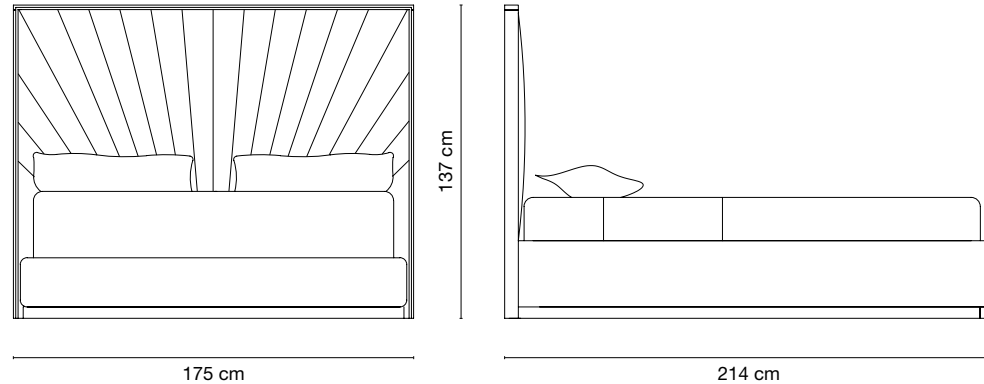
**TECHNICAL FEATURES**

**Structure:** solid beech wood and plywood, honeycomb MDF and chipboard panels

**Headboard, footboard and sides:** padding in variable density high-resistance foam polyurethane / non-removable cover

**Piping:** gros grain

**Mattress' support:** metal bed frame with wooden slats

**Protective glides:** felt

**Mattress (not included):** size 160 x 200 x h.22 cm

Cushions and bed set not included

Packaging	not assembled	cbm.	kg.
Standard	●	0,94	117
Wooden crate**	●	1,66	*

\* weight to be confirmed \*\* slatted base not included

ELD 16E	Matt lacquered				Glossy lacquered			
	M001 M002 M003 M004 M005 M014	M006 M007 M011 M012 M013 M015 M018 M019	G001 G002 G003 G004 G005 G014	G006 G007 G011 G012 G013 G015 G018 G019				
Customer's fabric mtl. 7,00	●	●	●	●				
Fabric cat. A	●	●	●	●				
Fabric cat. B	●	●	●	●				
Fabric cat. C	●	●	●	●				
Fabric cat. D	●	●	●	●				



| GALLERY >

| BEDS >

| FINISHES >

| UPHOLSTERY >

Bed 180

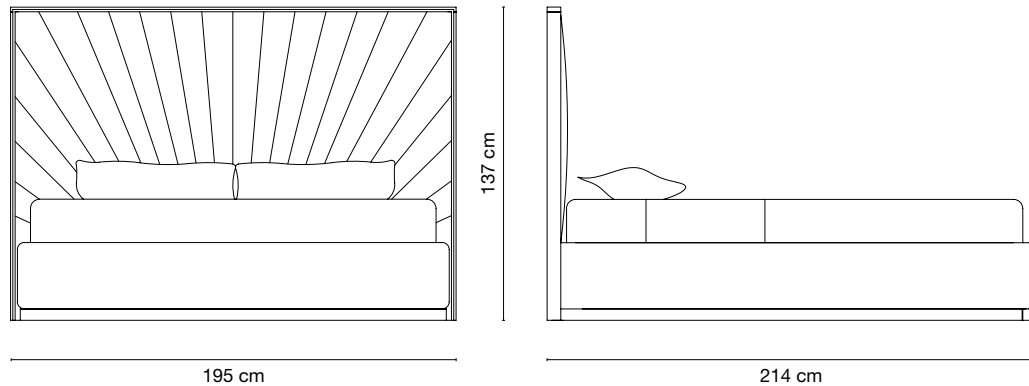
**TECHNICAL FEATURES****Structure:** solid beech wood and plywood, honeycomb MDF and chipboard panels**Headboard, footboard and sides:** padding in variable density high-resistance foam polyurethane / non-removable cover**Piping:** gros grain**Mattress' support:** metal bed frame with wooden slats**Protective glides:** felt**Mattress (not included):** size 180 x 200 x h.22 cm

Cushions and bed set not included

Packaging	not assembled	cbm.	kg.
Standard	●	1,02	128
Wooden crate**	●	1,78	*

\* weight to be confirmed \*\* slatted base not included

ELD 51A	Matt lacquered				Glossy lacquered			
	M001 M002 M003 M004 M005 M014	M006 M007 M011 M012 M013 M015 M018 M019	G001 G002 G003 G004 G005 G014	G006 G007 G011 G012 G013 G015 G018 G019				
Customer's fabric mtl. 7,20	●	●	●	●				
Fabric cat. A	●	●	●	●				
Fabric cat. B	●	●	●	●				
Fabric cat. C	●	●	●	●				
Fabric cat. D	●	●	●	●				



| GALLERY &gt;

| BEDS &gt;

| FINISHES &gt;

| UPHOLSTERY &gt;

## Storage bed 180

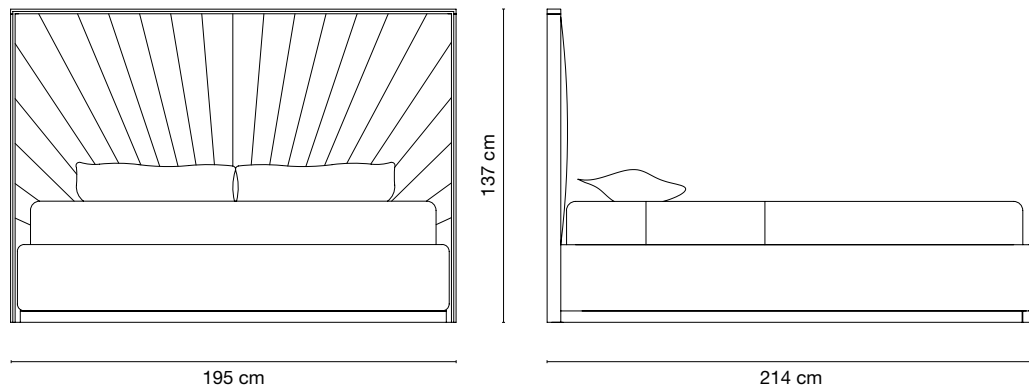

## TECHNICAL FEATURES

**Structure:** solid beech wood and plywood, honeycomb MDF and chipboard panels

**Headboard, footboard and sides:** padding in variable density high-resistance foam polyurethane / non-removable cover

**Piping:** gros grain

**Mattress' support:** metal bed frame with wooden slats and bed lift mechanism with full opening and horizontal stabilizer (mattress max. 45 kg)

**Protective glides:** felt

**Mattress (not included):** size 180 x 200 x h.22 cm

Cushions and bed set not included

Packaging	not assembled	cbm.	kg.
Standard	●	1,20	175
Wooden crate**	●	2,10	*

\* weight to be confirmed \*\* slatted base not included

ELD 53C	Matt lacquered				Glossy lacquered			
	M001 M002 M003 M004 M005 M014	M006 M007 M011 M012 M013 M015 M018 M019	G001 G002 G003 G004 G005 G014	G006 G007 G011 G012 G013 G015 G018 G019				
Customer's fabric mtl. 7,20	●	●	●	●				
Fabric cat. A	●	●	●	●				
Fabric cat. B	●	●	●	●				
Fabric cat. C	●	●	●	●				
Fabric cat. D	●	●	●	●				



| GALLERY >

| BEDS >

| FINISHES >

| UPHOLSTERY >

Bed 200

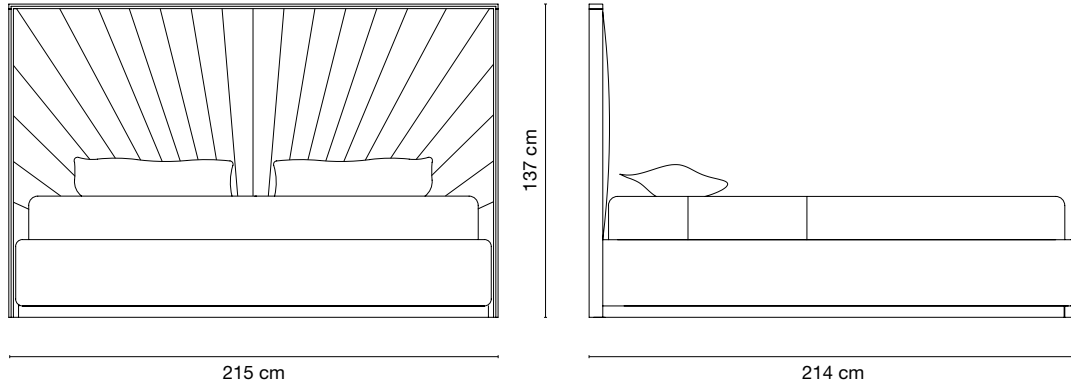
**TECHNICAL FEATURES****Structure:** solid beech wood and plywood, honeycomb MDF and chipboard panels**Headboard, footboard and sides:** padding in variable density high-resistance foam polyurethane / non-removable cover**Piping:** gros grain**Mattress' support:** metal bed frame with wooden slats**Protective glides:** felt**Mattress (not included):** size 200 x 200 x h.22 cm

Cushions and bed set not included

Packaging	not assembled	cbm.	kg.
Standard	●	1,08	145
Wooden crate**	●	1,88	*

\* weight to be confirmed \*\* slatted base not included

ELD 52B	Matt lacquered				Glossy lacquered			
	M001 M002 M003 M004 M005 M014	M006 M007 M011 M012 M013 M015 M018 M019	G001 G002 G003 G004 G005 G014	G006 G007 G011 G012 G013 G015 G018 G019				
Customer's fabric mtl. 7,60	●	●	●	●				
Fabric cat. A	●	●	●	●				
Fabric cat. B	●	●	●	●				
Fabric cat. C	●	●	●	●				
Fabric cat. D	●	●	●	●				



| GALLERY &gt;

| BEDS &gt;

| FINISHES &gt;

| UPHOLSTERY &gt;



With its linear but soft shapes, this beautiful console will be a refined touch for an entrance hall, giving an elegant tone to the house. The satin brass of its sinuous base and thin legs, raise and highlight the brass frame, which welcomes and protects the top in precious natural marble. The charming appearance of this piece will donate a sophisticated elegance and timeless style to any environment.

**Marble top finishes:** Bianco Carrara natural / Nero Marquinia natural / Breccia Medicea natural / Sahara Noir polyester / Patagonia natural

**Structure finishes:** satin brass

 | [VIEW ON WEBSITE](#) >

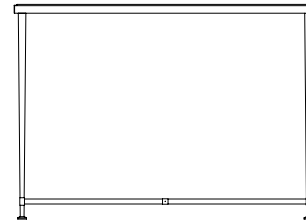

**FER 03C**  
Console >

 | [GALLERY](#) >

 | [CONSOLES](#) >

 | [FINISHES](#) >

 | [UPHOLSTERY](#) >

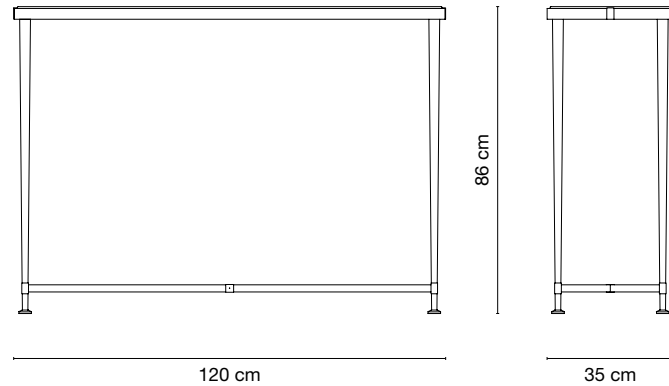

Console

**TECHNICAL FEATURES****Top:** marble 20 mm thick**Structure:** satin brass**Protective glides:** soft non-scratch rubber

Packaging	not assembled	cbm.	kg.
Standard**	●	0,58	49
Pallet**	●	0,66	*
Wooden crate	●	0,88	*

\* weight to be confirmed \*\* marble in wooden crate packaging

FER 03C	Brass		
	Satin ME.OTT.20		
Bianco Carrara	●		
Nero Marquina	●		
Breccia Medicea	●		
Sahara Noir	●		
Patagonia	●		



| GALLERY &gt;

| CONSOLES &gt;

| FINISHES &gt;

| UPHOLSTERY &gt;

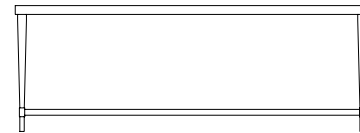

**FER 01A**  
Coffee table 120x80

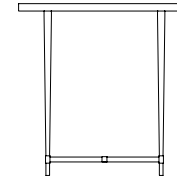

**FER 02B**  
Side table Ø70

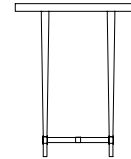

**FER 04D**  
Side table Ø50

With their linear but soft shapes, these beautiful coffee and side tables will be a refined touch for a living area, giving an elegant tone to the house. The satin brass of their sinuous base and thin legs, raises and highlights the brass frame, which welcomes and protects the top in precious natural marble. The charming appearance of these pieces will donate a sophisticated elegance and timeless style to any environment.

**Marble top finishes:** Bianco Carrara natural / Nero Marquinia natural / Breccia Medicea natural / Sahara Noir polyester / Patagonia natural

**Structure finishes:** satin brass

 | [VIEW ON WEBSITE](#) >

 | [GALLERY](#) >

 | [COFFEE AND SIDE TABLES](#) >

 | [FINISHES](#) >

 | [UPHOLSTERY](#) >

Coffee table 120x80

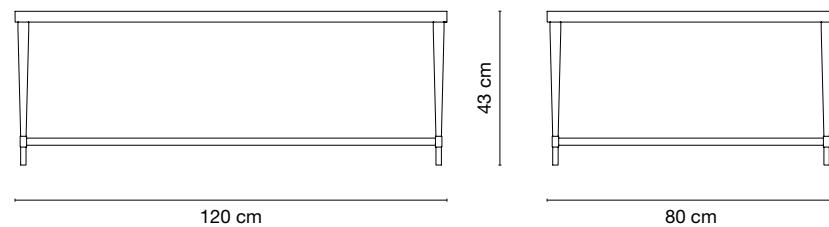
**TECHNICAL FEATURES****Top:** marble 20 mm thick**Structure:** satin brass**Protective glides:** soft non-scratch rubber

Packaging	not assembled	cbm.	kg.
Standard**	●	0,74	89
Pallet**	●	0,90	*
Wooden crate	●	1,10	*

\* weight to be confirmed \*\* marble in wooden crate packaging

FER 01A	Brass		
	Satin ME.OTT.20		
Bianco Carrara	●		
Nero Marquina	●		
Breccia Medicea	●		
Sahara Noir	●		
Patagonia	●		



| GALLERY &gt;

| COFFEE AND SIDE TABLES &gt;

| FINISHES &gt;

| UPHOLSTERY &gt;

# FERRANDO

 | Studio Galimberti - 2012

Side table Ø70

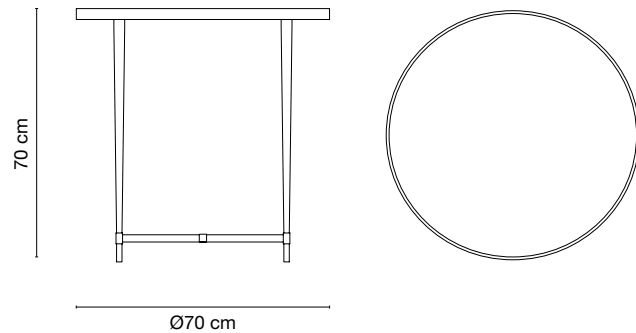
**TECHNICAL FEATURES**

Top: marble 20 mm thick

Structure: satin brass

Protective glides: soft non-scratch rubber

Packaging	not assembled	cbm.	kg.
Standard**	●	0,56	46
Pallet**	●	0,64	*
Wooden crate	●	0,82	*

\* weight to be confirmed \*\* marble in wooden crate packaging

FER 02B	Brass		
	Satin ME.OTT.20		
Bianco Carrara	●		
Nero Marquina	●		
Breccia Medicea	●		
Sahara Noir	●		
Patagonia	●		



| GALLERY &gt;

| COFFEE AND SIDE TABLES &gt;

| FINISHES &gt;

| UPHOLSTERY &gt;

# FERRANDO

 | Studio Galimberti - 2012

Side table Ø50

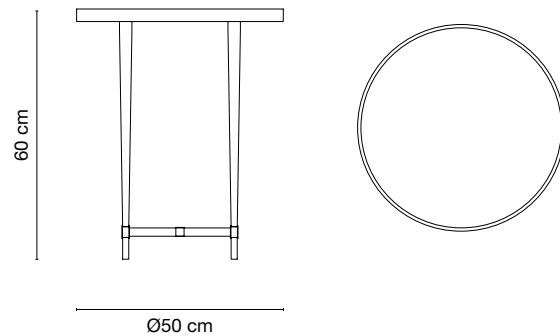
**TECHNICAL FEATURES**

Top: marble 20 mm thick

Structure: satin brass

Protective glides: soft non-scratch rubber

Packaging	not assembled	cbm.	kg.
Standard**	●	0,28	34
Pallet**	●	0,34	*
Wooden crate	●	0,44	*

\* weight to be confirmed \*\* marble in wooden crate packaging

FER 04D	Brass		
	Satin ME.OTT.20		
Bianco Carrara	●		
Nero Marquina	●		
Breccia Medicea	●		
Sahara Noir	●		
Patagonia	●		



| GALLERY &gt;

| COFFEE AND SIDE TABLES &gt;

| FINISHES &gt;

| UPHOLSTERY &gt;

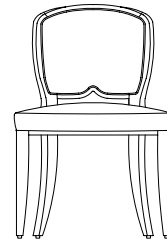

**GEM 21A**  
Dining chair

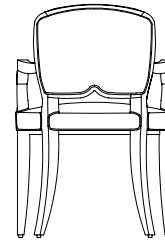

**GEM 22B**  
Dining arm chair



A superb addition to a modern or classic home, this chair is versatile and elegant and it will best express itself both around an important dining table, in a study or in the entrance area. Its wooden structure with rigorous and fluid shapes, highlights its exquisite craftsmanship.

**Covers:** fabric / leather

**Structure finishes:** matt and glossy lacquer in the Galimberti Nino colour range



VIEW ON WEBSITE



GALLERY



CHAIRS



FINISHES



UPHOLSTERY



# GEMMA

 | Studio Galimberti - 2014

Dining chair

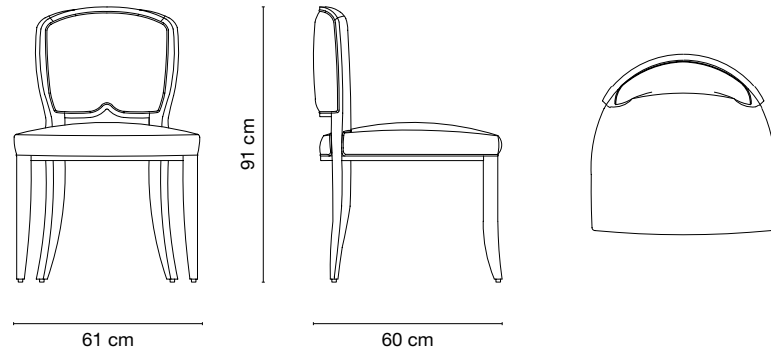
**TECHNICAL FEATURES****Structure:** solid beech wood**Seat and backrest:** padding in variable density high-resistance foam polyurethane / seat with elastic straps / non-removable cover**Piping:** gros grain**Protective glides:** felt

Packaging	assembled	cbm.	kg.
Standard	●	0,36	12
Pallet	●	0,42	*
Wooden crate	●	0,60	*

\* weight to be confirmed

GEM 21A	Matt lacquered				Glossy lacquered			
	M001 M002 M003 M004 M005 M014	M006 M007 M011 M012 M013 M015 M018 M019	G001 G002 G003 G004 G005 G014	G006 G007 G011 G012 G013 G015 G018 G019				
Customer's fabric mtl. 1,30	●	●	●	●				
Fabric cat. A	●	●	●	●				
Fabric cat. B	●	●	●	●				
Fabric cat. C	●	●	●	●				
Fabric cat. D	●	●	●	●				
Leather	●	●	●	●				
Leather Lux	●	●	●	●				



| GALLERY &gt;

| CHAIRS &gt;

| FINISHES &gt;

| UPHOLSTERY &gt;

# GEMMA

 | Studio Galimberti - 2014

Dining arm chair

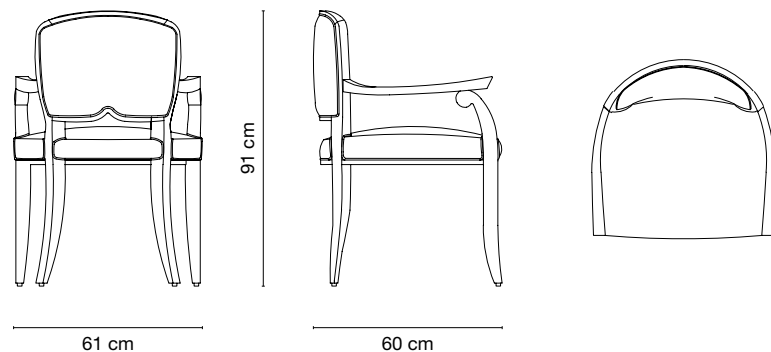
**TECHNICAL FEATURES****Structure:** solid beech wood**Seat and backrest:** padding in variable density high-resistance foam polyurethane / seat with elastic straps / non-removable cover**Piping:** gros grain**Protective glides:** felt

Packaging	assembled	cbm.	kg.
Standard	●	0,36	14
Pallet	●	0,42	*
Wooden crate	●	0,60	*

\* weight to be confirmed

GEM 22B	Matt lacquered				Glossy lacquered			
	M001 M002 M003 M004 M005 M014	M006 M007 M011 M012 M013 M015 M018 M019	G001 G002 G003 G004 G005 G014	G006 G007 G011 G012 G013 G015 G018 G019				
Customer's fabric mtl. 1,30	●	●	●	●				
Fabric cat. A	●	●	●	●				
Fabric cat. B	●	●	●	●				
Fabric cat. C	●	●	●	●				
Fabric cat. D	●	●	●	●				
Leather	●	●	●	●				
Leather Lux	●	●	●	●				

| GALLERY &gt;

| CHAIRS &gt;

| FINISHES &gt;

| UPHOLSTERY &gt;



GILDA / GILDA BI | Studio Galimberti - 2009



**GIL 41A**  
Dining chair



**GIB 91A**  
Dining chair



This exquisite chair combines a sinuous silhouette with comfortable seating experience. Either behind a desk in a study, as an accent piece in an entryway or around a dining table, this chair will be a precious addition to both modern and classic homes.

**Covers:** fabric

**Structure finishes:** matt and glossy lacquer in the Galimberti Nino colour range



VIEW ON WEBSITE



GALLERY



CHAIRS



FINISHES



UPHOLSTERY

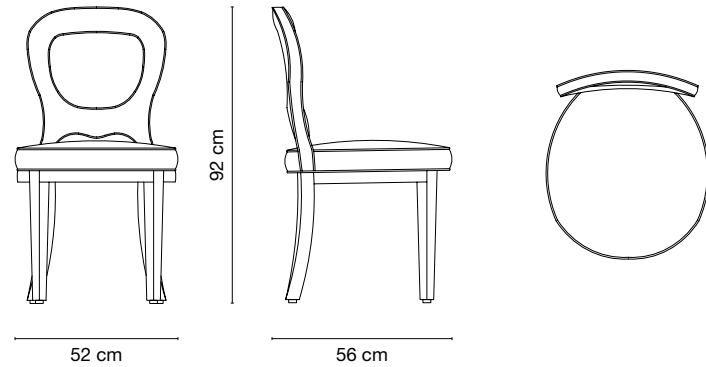

Dining chair

**TECHNICAL FEATURES****Structure:** solid beech wood**Seat and backrest:** padding in variable density high-resistance foam polyurethane / seat with plywood panel / non-removable cover**Piping:** gros grain**Protective glides:** felt

Packaging	assembled 1pc	cbm.	kg.	assembled 2pc	cbm.	kg.
Standard	●	0,34	10	●	0,34	19
Pallet	●	0,38	*	●	0,38	*
Wooden crate	●	0,56	*	●	0,56	*

\* weight to be confirmed

GIL 41A	Matt lacquered				Glossy lacquered			
	M001 M002 M003 M004 M005 M014	M006 M007 M011 M012 M013 M015 M018 M019	G001 G002 G003 G004 G005 G014	G006 G007 G011 G012 G013 G015 G018 G019				
Customer's fabric mtl. 1,50	●	●	●	●				
Fabric cat. A	●	●	●	●				
Fabric cat. B	●	●	●	●				
Fabric cat. C	●	●	●	●				
Fabric cat. D	●	●	●	●				



[GALLERY](#) >

[CHAIRS](#) >

[FINISHES](#) >

[UPHOLSTERY](#) >

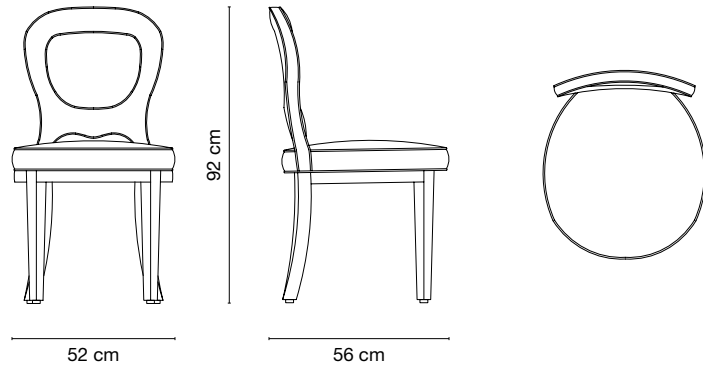
## Dining chair

**TECHNICAL FEATURES****Structure:** solid beech wood**Seat and backrest:** padding in variable density high-resistance foam polyurethane / seat with plywood panel / non-removable cover**Piping:** gros grain**Protective glides:** felt

Packaging	assembled 1pc	cbm.	kg.	assembled 2pc	cbm.	kg.
Standard	●	0,34	10	●	0,34	19
Pallet	●	0,38	*	●	0,38	*
Wooden crate	●	0,56	*	●	0,56	*

\* weight to be confirmed

GIB 91A	Matt lacquered				Glossy lacquered			
	M001 M002 M003 M004 M005 M014	M006 M007 M011 M012 M013 M015 M018 M019	G001 G002 G003 G004 G005 G014	G006 G007 G011 G012 G013 G015 G018 G019				
Customer's fabric mtl. 1,50	●	●	●	●				
Fabric cat. A	●	●	●	●				
Fabric cat. B	●	●	●	●				
Fabric cat. C	●	●	●	●				
Fabric cat. D	●	●	●	●				



| GALLERY &gt;

| CHAIRS &gt;

| FINISHES &gt;

| UPHOLSTERY &gt;

# GILDA COVER / GILDA BI COVER | Studio Galimberti - 2009

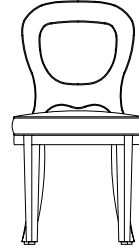

**GIL 42B**  
Dining chair



**GIB 92B**  
Dining chair



This exquisite chair combines a sinuous silhouette with comfortable seating experience. Either behind a desk in a study, as an accent piece in an entryway or around a dining table, this chair will be a precious addition to both modern and classic homes.

**Covers:** fabric



**VIEW ON WEBSITE**



**GALLERY**



**CHAIRS**



**FINISHES**



**UPHOLSTERY**



# GILDA COVER | Studio Galimberti - 2009

Dining chair

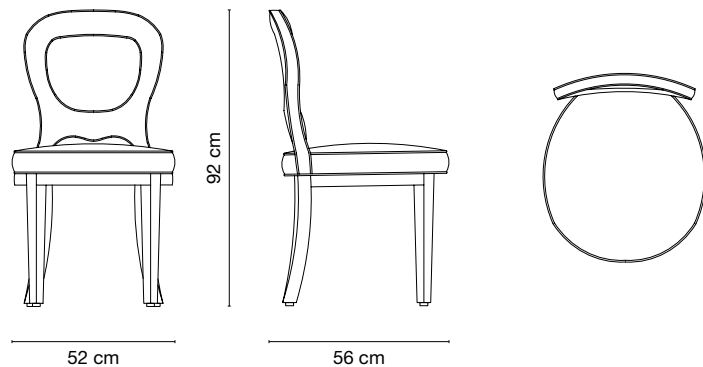

## TECHNICAL FEATURES

**Structure:** solid beech wood

**Seat and backrest:** padding in variable density high-resistance foam polyurethane / seat with plywood panel / non-removable cover

**Piping:** gros grain

**Protective glides:** felt

Packaging	assembled 1pc	cbm.	kg.	assembled 2pc	cbm.	kg.
Standard	●	0,34	10	●	0,34	19
Pallet	●	0,38	*	●	0,38	*
Wooden crate	●	0,56	*	●	0,56	*

\* weight to be confirmed

GIL 42B		
Customer's fabric mtl. 2,00	●	
Fabric cat. A	●	
Fabric cat. B	●	
Fabric cat. C	●	
Fabric cat. D	●	



| GALLERY >

| CHAIRS >

| FINISHES >

| UPHOLSTERY >

# GILDA BI COVER | Studio Galimberti - 2009

Dining chair

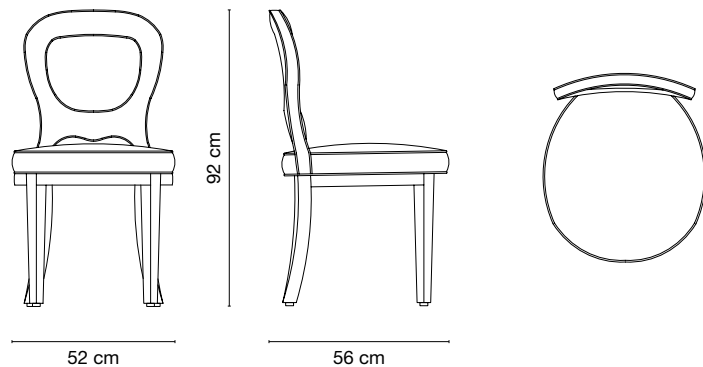
**TECHNICAL FEATURES****Structure:** solid beech wood**Seat and backrest:** padding in variable density high-resistance foam polyurethane / seat with plywood panel / non-removable cover**Piping:** gros grain**Protective glides:** felt

Packaging	assembled 1pc	cbm.	kg.	assembled 2pc	cbm.	kg.
Standard	●	0,34	10	●	0,34	19
Pallet	●	0,38	*	●	0,38	*
Wooden crate	●	0,56	*	●	0,56	*

*\* weight to be confirmed*

GIB 92B		
Customer's fabric mtl. 2,00	●	
Fabric cat. A	●	
Fabric cat. B	●	
Fabric cat. C	●	
Fabric cat. D	●	

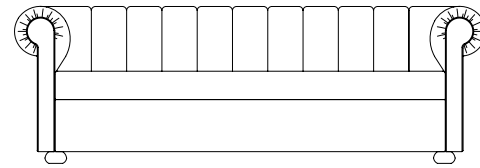

[GALLERY](#)
[CHAIRS](#)
[FINISHES](#)
[UPHOLSTERY](#)

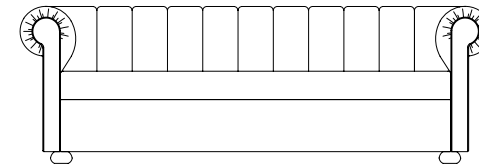

**GIO 23C**  
3 seat sofa bed

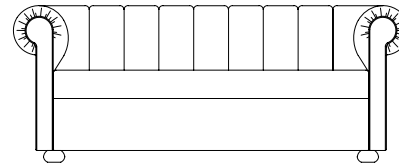

**GIO 24D**  
3 seat sofa



**GIO 31C**  
2 seat sofa bed

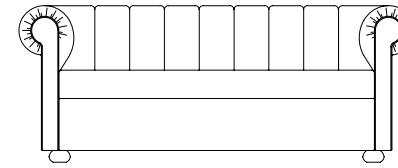

**GIO 33D**  
2 seat sofa





The tradition of shapes and proportions is expressed with sublime elegance in Giorgio sofas revealing itself decisively in the fine worked quilts of the backrest and armrests. This beautiful collection of the upholstered furniture will infuse a timeless charm in every ambience of the house, both classic and contemporary, and it will be noticed and appreciated as a presence of pure class even in an absolutely modern location.

**Covers:** fabric / leather

**Base finishes:** matt and glossy lacquer in the Galimberti Nino colour range / natural walnut / honey walnut / matt and glossy tobacco walnut / moreo walnut

 | [VIEW ON WEBSITE](#) >

 | [GALLERY](#) >

 | [SOFAS](#) >

 | [FINISHES](#) >

 | [UPHOLSTERY](#) >

## 3 seat sofa bed

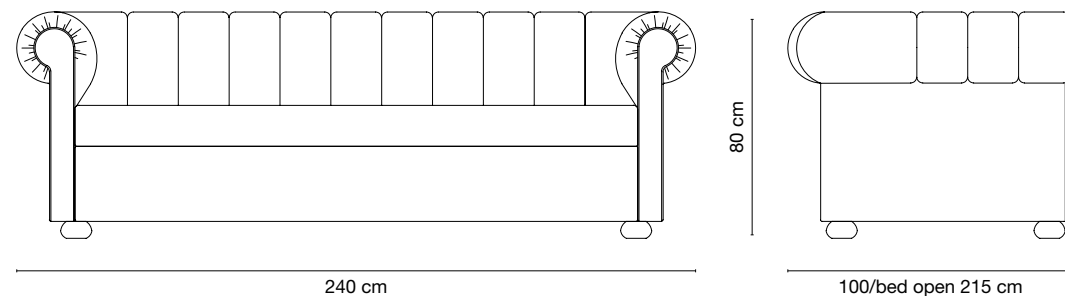

## TECHNICAL FEATURES

**Structure:** solid wood**Backrest and base:** padding in variable density high-resistance foam polyurethane / non-removable cover**Cushion:** high-resistance foam polyurethane with memory foam inset and polyester fiber lining / removable cover**Legs:** solid beech wood / solid walnut**Protective glides:** felt**Mechanism:** three fold sofa bed with opening operations of two movements / wooden slats**Mattress:** size 155 x 185 x h.8 cm / Bonnel springs

Cushions not included

Packaging	assembled	cbm.	kg.
Standard	●	2,20	136
Pallet	●	2,58	*
Wooden crate	●	3,08	*

\* weight to be confirmed

GIO 23C	Matt lacquered				Glossy lacquered				Matt walnut				Glossy walnut
	M001 M002 M003 M004 M005 M014	M006 M007 M011 M012 M013 M015 M018 M019	G001 G002 G003 G004 G005 G014	G006 G007 G011 G012 G013 G015 G018 G019	Natural Walnut NO.020.NA	Honey Walnut NO.020.MI	Tobacco Walnut NO.020.TA	Moro Walnut NO.020.MO	Tobacco Walnut NO.100.TA				
Customer's fabric mtl. 12,50	●	●	●	●	●	●	●	●	●				
Fabric cat. A	●	●	●	●	●	●	●	●	●				
Fabric cat. B	●	●	●	●	●	●	●	●	●				
Fabric cat. C	●	●	●	●	●	●	●	●	●				
Fabric cat. D	●	●	●	●	●	●	●	●	●				
Leather	●	●	●	●	●	●	●	●	●				
Leather Lux	●	●	●	●	●	●	●	●	●				

| GALLERY &gt;

| SOFAS &gt;

| FINISHES &gt;

| UPHOLSTERY &gt;



## GIORGIO | Studio Galimberti - 2020

3 seat sofa

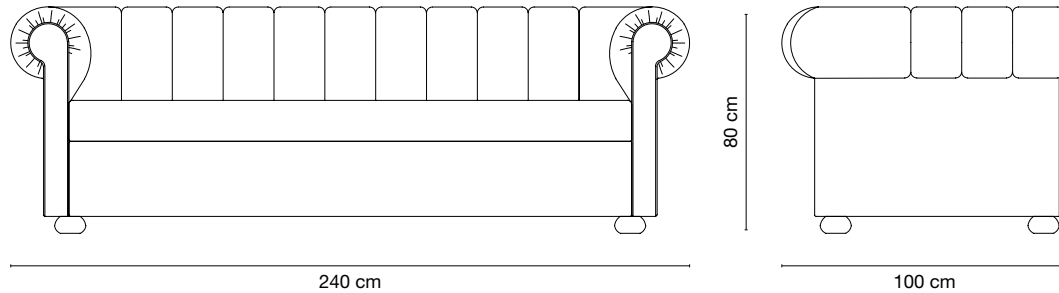

## TECHNICAL FEATURES

**Structure:** solid wood**Seat and backrest:** padding in variable density high-resistance foam polyurethane / seat with elastic straps / non-removable cover**Cushion:** high-resistance foam polyurethane with memory foam inset and polyester fiber lining / removable cover**Legs:** solid beech wood / solid walnut**Protective glides:** felt

Cushions not included

Packaging	assembled	cbm.	kg.
Standard	●	2,20	90
Pallet	●	2,58	*
Wooden crate	●	3,08	*

\* weight to be confirmed

GIO 24D	Matt lacquered				Glossy lacquered				Matt walnut				Glossy walnut
	M001 M002 M003 M004 M005 M014	M006 M007 M011 M012 M013 M015 M018 M019	G001 G002 G003 G004 G005 G014	G006 G007 G011 G012 G013 G015 G018 G019	Natural Walnut NO.020.NA	Honey Walnut NO.020.MI	Tobacco Walnut NO.020.TA	Moro Walnut NO.020.MO	Tobacco Walnut NO.100.TA				
Customer's fabric mtl. 12,50	●	●	●	●	●	●	●	●	●				
Fabric cat. A	●	●	●	●	●	●	●	●	●				
Fabric cat. B	●	●	●	●	●	●	●	●	●				
Fabric cat. C	●	●	●	●	●	●	●	●	●				
Fabric cat. D	●	●	●	●	●	●	●	●	●				
Leather	●	●	●	●	●	●	●	●	●				
Leather Lux	●	●	●	●	●	●	●	●	●				

| GALLERY &gt;

| SOFAS &gt;

| FINISHES &gt;

| UPHOLSTERY &gt;

## 2 seat sofa bed

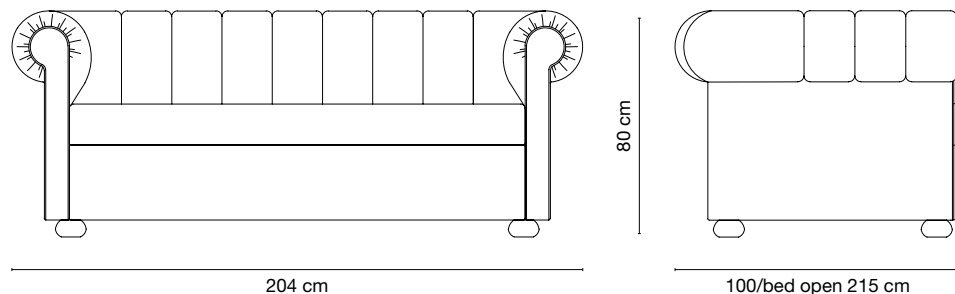

## TECHNICAL FEATURES

**Structure:** solid wood**Backrest and base:** padding in variable density high-resistance foam polyurethane / non-removable cover**Cushion:** high-resistance foam polyurethane with memory foam inset and polyester fiber lining / removable cover**Legs:** solid beech wood / solid walnut**Protective glides:** felt**Mechanism:** three fold sofa bed with opening operations of two movements / wooden slats**Mattress:** size 125 x 185 x h.8 cm / Bonnel springs

Cushions not included

Packaging	assembled	cbm.	kg.
Standard	●	1,88	126
Pallet	●	2,22	*
Wooden crate	●	2,66	*

\* weight to be confirmed

GIO 31C	Matt lacquered				Glossy lacquered				Matt walnut				Glossy walnut
	M001 M002 M003 M004 M005 M014	M006 M007 M011 M012 M013 M015 M018 M019	G001 G002 G003 G004 G005 G014	G006 G007 G011 G012 G013 G015 G018 G019	Natural Walnut NO.020.NA	Honey Walnut NO.020.MI	Tobacco Walnut NO.020.TA	Moro Walnut NO.020.MO	Tobacco Walnut NO.100.TA				
Customer's fabric mtl. 11,50	●	●	●	●	●	●	●	●	●				
Fabric cat. A	●	●	●	●	●	●	●	●	●				
Fabric cat. B	●	●	●	●	●	●	●	●	●				
Fabric cat. C	●	●	●	●	●	●	●	●	●				
Fabric cat. D	●	●	●	●	●	●	●	●	●				
Leather	●	●	●	●	●	●	●	●	●				
Leather Lux	●	●	●	●	●	●	●	●	●				

| GALLERY &gt;

| SOFAS &gt;

| FINISHES &gt;

| UPHOLSTERY &gt;

## GIORGIO | Studio Galimberti - 2020

2 seat sofa

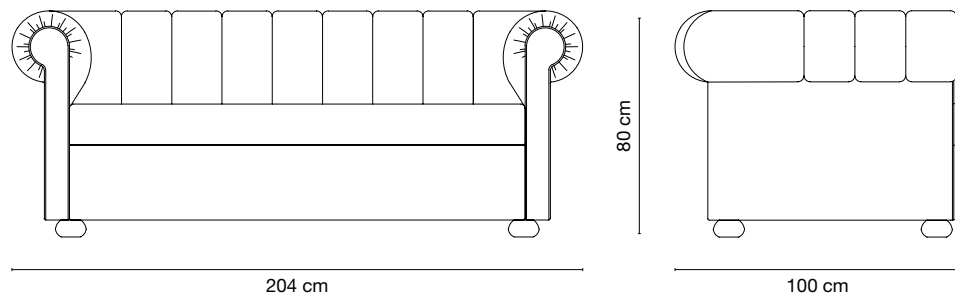

## TECHNICAL FEATURES

**Structure:** solid wood**Seat and backrest:** padding in variable density high-resistance foam polyurethane / seat with elastic straps / non-removable cover**Cushion:** high-resistance foam polyurethane with memory foam inset and polyester fiber lining / removable cover**Legs:** solid beech wood / solid walnut**Protective glides:** felt

Cushions not included

Packaging	assembled	cbm.	kg.
Standard	●	1,88	82
Pallet	●	2,22	*
Wooden crate	●	2,66	*

\* weight to be confirmed

GIO 33D	Matt lacquered				Glossy lacquered				Matt walnut				Glossy walnut
	M001 M002 M003 M004 M005 M014	M006 M007 M011 M012 M013 M015 M018 M019	G001 G002 G003 G004 G005 G014	G006 G007 G011 G012 G013 G015 G018 G019	Natural Walnut NO.020.NA	Honey Walnut NO.020.MI	Tobacco Walnut NO.020.TA	Moro Walnut NO.020.MO	Tobacco Walnut NO.100.TA				
Customer's fabric mtl. 11,50	●	●	●	●	●	●	●	●	●				
Fabric cat. A	●	●	●	●	●	●	●	●	●				
Fabric cat. B	●	●	●	●	●	●	●	●	●				
Fabric cat. C	●	●	●	●	●	●	●	●	●				
Fabric cat. D	●	●	●	●	●	●	●	●	●				
Leather	●	●	●	●	●	●	●	●	●				
Leather Lux	●	●	●	●	●	●	●	●	●				

| GALLERY &gt;

| SOFAS &gt;

| FINISHES &gt;

| UPHOLSTERY &gt;

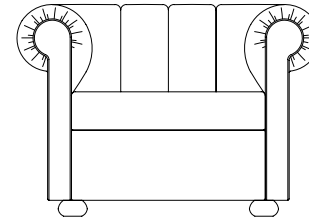



**GIO 40A**  
Club chair

The tradition of shapes and proportions is expressed with sublime elegance in Giorgio club chair revealing itself decisively in the fine worked quilts of the backrest and armrests. This beautiful collection of the upholstered furniture will infuse a timeless charm in every ambience of the house, both classic and contemporary, and it will be noticed and appreciated as a presence of pure class even in an absolutely modern location.

**Covers:** fabric / leather

**Base finishes:** matt and glossy lacquer in the Galimberti Nino colour range / natural walnut / honey walnut / matt and glossy tobacco walnut / moro walnut

 | GALLERY >

 | ARMCHAIRS AND OTTOMANS >

 | FINISHES >

 | UPHOLSTERY >

Club chair

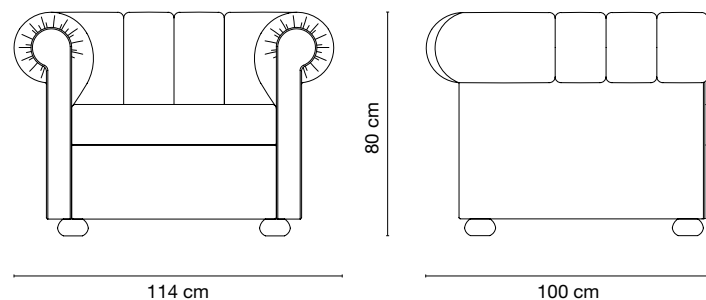
**TECHNICAL FEATURES****Structure:** solid wood**Seat and backrest:** padding in variable density high-resistance foam polyurethane / seat with elastic straps / non-removable cover**Cushion:** high-resistance foam polyurethane with memory foam inset and polyester fiber lining / removable cover**Legs:** solid beech wood / solid walnut**Protective glides:** felt

Packaging	assembled	cbm.	kg.
Standard	●	1,08	48
Pallet	●	1,26	*
Wooden crate	●	1,58	*

\* weight to be confirmed

GIO 40A	Matt lacquered				Glossy lacquered				Matt walnut				Glossy walnut
	M001 M002 M003 M004 M005 M014	M006 M007 M011 M012 M013 M015 M018 M019	G001 G002 G003 G004 G005 G014	G006 G007 G011 G012 G013 G015 G018 G019	Natural Walnut NO.020.NA	Honey Walnut NO.020.MI	Tobacco Walnut NO.020.TA	Moro Walnut NO.020.MO	Tobacco Walnut NO.100.TA				
Customer's fabric mtl. 8,00	●	●	●	●	●	●	●	●	●				
Fabric cat. A	●	●	●	●	●	●	●	●	●				
Fabric cat. B	●	●	●	●	●	●	●	●	●				
Fabric cat. C	●	●	●	●	●	●	●	●	●				
Fabric cat. D	●	●	●	●	●	●	●	●	●				
Leather	●	●	●	●	●	●	●	●	●				
Leather Lux	●	●	●	●	●	●	●	●	●				

| GALLERY &gt;

| ARMCHAIRS AND OTTOMANS &gt;

| FINISHES &gt;

| UPHOLSTERY &gt;

**HIRO** | Ilenia Viscardi - 2019



Celebrating the essence of pure form, suitable for modern and classic decors, the contrasting textures of marble top and wooden legs confer sophistication and character to the piece. A stunning combination of natural materials and fine craftsmanship, this dining table redefines interiors with its sleek silhouette and architectural presence.

**Marble top finishes:** Bianco Carrara natural / Nero Marquinia natural / Breccia Medicea natural / Sahara Noir polyester / Patagonia natural

**Columns finishes:** natural walnut / honey walnut / matt and glossy tobacco walnut / moro walnut

**Metal structure and legs ferrules finishes:** matt black

 | [VIEW ON WEBSITE](#) >



**HIR 21N**  
Dining table >

 | [GALLERY](#) >

 | [DINING TABLES](#) >

 | [FINISHES](#) >

 | [UPHOLSTERY](#) >

HIRO | Ilenia Viscardi - 2019

Dining table

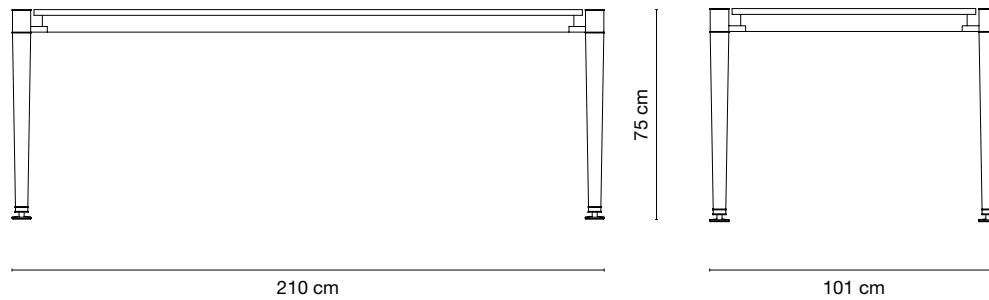
**TECHNICAL FEATURES****Top:** marble 20 mm thick coupled with a melamine chipboard panel**Undermount structure:** painted metal**Columns:** solid walnut**Legs ferrules:** painted metal**Protective glides:** soft non-scratch rubber

Packaging	not assembled	cbm.	kg.
Standard**	●	0,94	225
Wooden crate	●	1,32	*

\* weight to be confirmed \*\* marble in wooden crate packaging

HIR 21N	Matt walnut				Glossy walnut
	Natural Walnut NO.020.NA	Honey Walnut NO.020.MI	Tobacco Walnut NO.020.TA	Moro Walnut NO.020.MO	Tobacco Walnut NO.100.TA
Bianco Carrara	●	●	●	●	●
Nero Marquina	●	●	●	●	●
Breccia Medicea	●	●	●	●	●
Sahara Noir	●	●	●	●	●
Patagonia	●	●	●	●	●

 | GALLERY >

 | DINING TABLES >

 | FINISHES >

 | UPHOLSTERY >



**HIR 22N**  
Dining table

Celebrating the essence of pure form, suitable for modern and classic decors, with its stunning combination of natural materials and fine craftsmanship, this dining table redefines interiors with its sleek silhouette and architectural presence.

**Top and columns finishes:** natural walnut / honey walnut / matt and glossy tobacco walnut / moro walnut

**Metal structure and legs ferrules finishes:** matt black

 | GALLERY >

 | DINING TABLES >

 | FINISHES >

 | UPHOLSTERY >



# HIRO WO

Ilenia Viscardi - 2019

Dining table

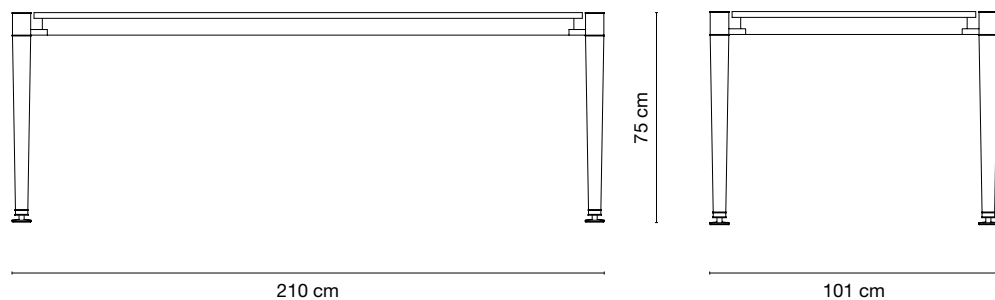
**TECHNICAL FEATURES****Top:** chipboard panel covered with walnut wood veneer**Undermount structure:** painted metal**Columns:** solid walnut**Legs ferrules:** painted metal**Protective glides:** soft non-scratch rubber

Packaging	not assembled	cbm.	kg.
Standard	●	0,46	56
Wooden crate	●	0,86	*

*\* weight to be confirmed*

HIR 22N	Matt walnut				Glossy walnut
	Natural Walnut NO.020.NA	Honey Walnut NO.020.MI	Tobacco Walnut NO.020.TA	Moro Walnut NO.020.MO	Tobacco Walnut NO.100.TA
	●	●	●	●	●

 | GALLERY >

 | DINING TABLES >

 | FINISHES >

 | UPHOLSTERY >

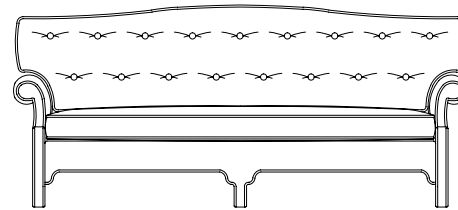

**HOL 11A**  
Sofa >

The charm of traditional style and exquisite craftsmanship create a beautiful piece of decor that is both elegantly decorative and comfortably functional. The structure, completely upholstered, features a generous seat, capitonnè back and curved welcoming armrests. This sofa will add a decorative and timeless touch to any living room or study.

**Covers:** fabric

| [VIEW ON WEBSITE](#) >

| [GALLERY](#) >

| [SOFAS](#) >

| [FINISHES](#) >

| [UPHOLSTERY](#) >

# HOLLYWOOD

 | Studio Galimberti - 2008

Sofa

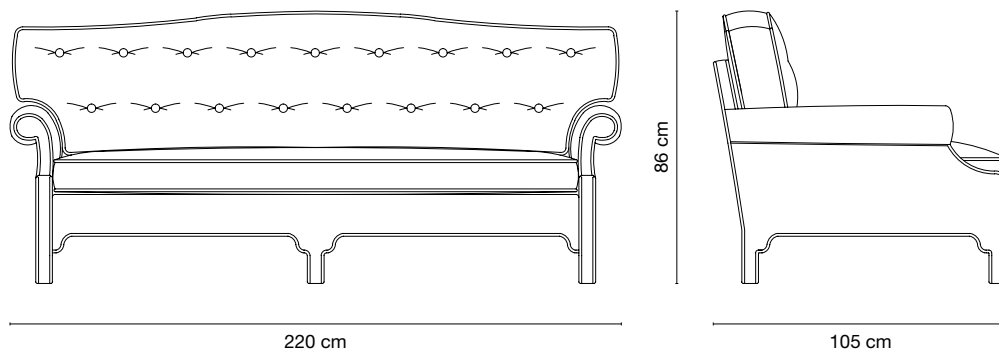

### TECHNICAL FEATURES

**Structure:** solid wood

**Seat and backrest:** padding in variable density high-resistance foam polyurethane / seat with elastic straps / non-removable cover

**Cushions:** goose down divided into sections with high-resistance foam polyurethane inset / backrest with non removable cover / seat with removable cover

**Piping:** gros grain

**Protective glides:** felt

Packaging	assembled	cbm.	kg.
Standard	●	2,60	76
Pallet	●	2,98	*
Wooden crate	●	3,54	*

\* weight to be confirmed

HOL 11A		
Customer's fabric mtl. 14,50	●	
Fabric cat. A	●	
Fabric cat. B	●	
Fabric cat. C	●	
Fabric cat. D	●	



| GALLERY >

| SOFAS >

| FINISHES >

| UPHOLSTERY >

**HOLLYWOOD** | Studio Galimberti - 2008

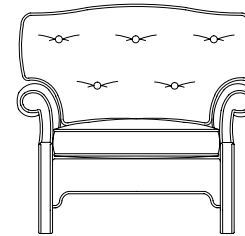



**HOL 12B**  
Club chair

The charm of traditional style and exquisite craftsmanship create a beautiful piece of decor that is both elegantly decorative and comfortably functional. The structure, completely upholstered, features a generous seat, capitonnè back and curved welcoming armrests. This club chair will add a decorative and timeless touch to any living room or study.

**Covers:** fabric

 | [VIEW ON WEBSITE](#) >

 | [GALLERY](#) >

 | [ARMCHAIRS AND OTTOMANS](#) >

 | [FINISHES](#) >

 | [UPHOLSTERY](#) >

## HOLLYWOOD

Studio Galimberti - 2008

Club chair

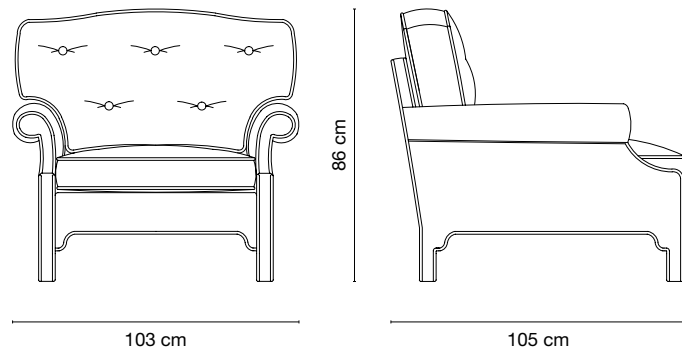

## TECHNICAL FEATURES

**Structure:** solid wood**Seat and backrest:** padding in variable density high-resistance foam polyurethane / seat with elastic straps / non-removable cover**Cushions:** goose down divided into sections with high-resistance foam polyurethane inset / backrest with non removable cover / seat with removable cover**Piping:** gros grain**Protective glides:** felt

Packaging	assembled	cbm.	kg.
Standard	●	1,22	37
Pallet	●	1,40	*
Wooden crate	●	1,74	*

\* weight to be confirmed

HOL 12B		
Customer's fabric mtl. 8,30	●	
Fabric cat. A	●	
Fabric cat. B	●	
Fabric cat. C	●	
Fabric cat. D	●	



| GALLERY &gt;

| ARMCHAIRS AND OTTOMANS &gt;

| FINISHES &gt;

| UPHOLSTERY &gt;

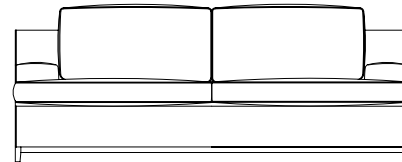

**HUG 23C**  
Sofa 212

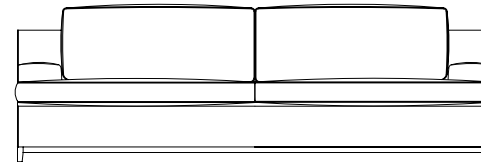

**HUG 25E**  
Sofa 252



The elegant silhouette of Hugo sofas and their comfortable structure are the distinctive traits of these pieces that invite to relax and entertain, providing ample seating space. The straight lines of the solid wood base, the soft cushions and minimalist accents make this collection a significant presence in any interior.

**Covers:** fabric

**Base finishes:** matt and glossy lacquer in the Galimberti Nino colour range / natural walnut / honey walnut / matt and glossy tobacco walnut / moro walnut



**VIEW ON WEBSITE**



**GALLERY**



**SOFAS**



**FINISHES**



**UPHOLSTERY**

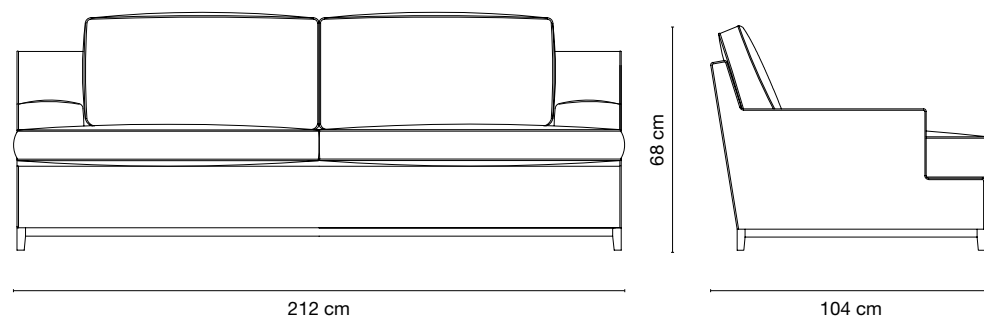

## Sofa 212

**TECHNICAL FEATURES****Structure:** solid wood and plywood panels**Seat and backrest:** padding in variable density high-resistance foam polyurethane / seat with elastic straps / non-removable cover**Cushions:** goose down divided into sections with high-resistance foam polyurethane inset and polyester fiber lining / removable cover**Base:** solid beech wood / solid walnut**Piping:** gros grain**Protective glides:** felt

Packaging	assembled	cbm.	kg.
Standard	●	2,04	85
Pallet	●	2,42	*
Wooden crate	●	2,88	*

\* weight to be confirmed

HUG 23C	Matt lacquered				Glossy lacquered				Matt walnut				Glossy walnut
	M001 M002 M003 M004 M005 M014	M006 M007 M011 M012 M013 M015 M018 M019	G001 G002 G003 G004 G005 G014	G006 G007 G011 G012 G013 G015 G018 G019	Natural Walnut NO.020.NA	Honey Walnut NO.020.MI	Tobacco Walnut NO.020.TA	Moro Walnut NO.020.MO	Tobacco Walnut NO.100.TA				
Customer's fabric mtl. 14,00	●	●	●	●	●	●	●	●	●				
Fabric cat. A	●	●	●	●	●	●	●	●	●				
Fabric cat. B	●	●	●	●	●	●	●	●	●				
Fabric cat. C	●	●	●	●	●	●	●	●	●				
Fabric cat. D	●	●	●	●	●	●	●	●	●				

| GALLERY &gt;

| SOFAS &gt;

| FINISHES &gt;

| UPHOLSTERY &gt;

Sofa 252

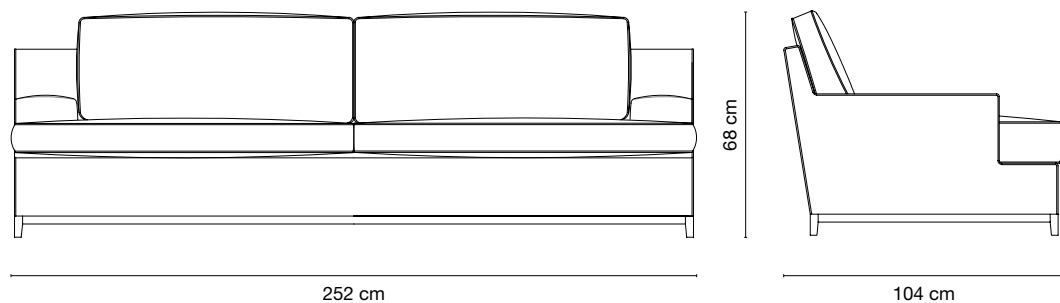
**TECHNICAL FEATURES****Structure:** solid wood and plywood panels**Seat and backrest:** padding in variable density high-resistance foam polyurethane / seat with elastic straps / non-removable cover**Cushions:** goose down divided into sections with high-resistance foam polyurethane inset and polyester fiber lining / removable cover**Base:** solid beech wood / solid walnut**Piping:** gros grain**Protective glides:** felt

Packaging	assembled	cbm.	kg.
Standard	●	2,40	100
Pallet	●	2,86	*
Wooden crate	●	3,38	*

\* weight to be confirmed

HUG 25E	Matt lacquered				Glossy lacquered				Matt walnut				Glossy walnut
	M001 M002 M003 M004 M005 M014	M006 M007 M011 M012 M013 M015 M018 M019	G001 G002 G003 G004 G005 G014	G006 G007 G011 G012 G013 G015 G018 G019	Natural Walnut NO.020.NA	Honey Walnut NO.020.MI	Tobacco Walnut NO.020.TA	Moro Walnut NO.020.MO	Tobacco Walnut NO.100.TA				
Customer's fabric mtl. 16,00	●	●	●	●	●	●	●	●	●				
Fabric cat. A	●	●	●	●	●	●	●	●	●				
Fabric cat. B	●	●	●	●	●	●	●	●	●				
Fabric cat. C	●	●	●	●	●	●	●	●	●				
Fabric cat. D	●	●	●	●	●	●	●	●	●				

| GALLERY &gt;

| SOFAS &gt;

| FINISHES &gt;

| UPHOLSTERY &gt;



## MODULAR SOFAS



The elegant silhouette of Hugo modular sofas and their comfortable structure are the distinctive traits of these pieces that invite to relax and entertain, providing ample seating space. The straight lines of the solid wood base, the soft cushions and minimalist accents make this collection a significant presence in any interior.

**Covers:** fabric

**Base finishes:** matt and glossy lacquer in the Galimberti Nino colour range / natural walnut / honey walnut / matt and glossy tobacco walnut / more walnut

 | [VIEW ON WEBSITE](#) >

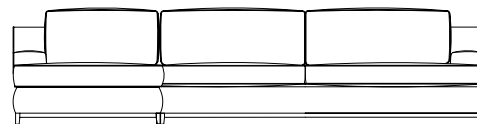

**HUG C11**  
Modular sofa 334x220  
with SX chaise longue >



**HUG C22**  
Modular sofa 294x220  
with SX chaise longue >

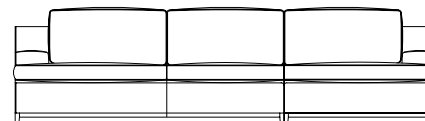

**HUG C33**  
Modular sofa 294x220  
with DX chaise longue >

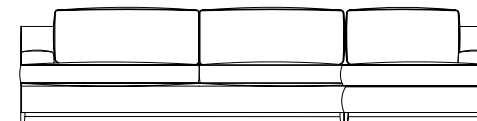

**HUG C44**  
Modular sofa 334x220  
with DX chaise longue >

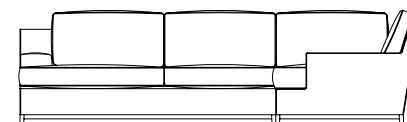

**HUG C66**  
Modular sofa 292x292 >

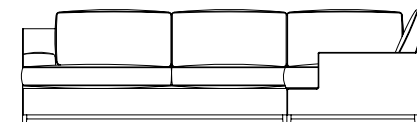

**HUG C77**  
Modular sofa 292x332 DX >





**HUG C88**  
Modular sofa 292x332 SX >





**HUG C99**  
Modular sofa 332x332 >



 | [GALLERY](#) >

 | [SOFAS](#) >

 | [FINISHES](#) >

 | [UPHOLSTERY](#) >

# HUGO | Studio Galimberti - 2017

Modular sofa 334x220 with SX chaise longue

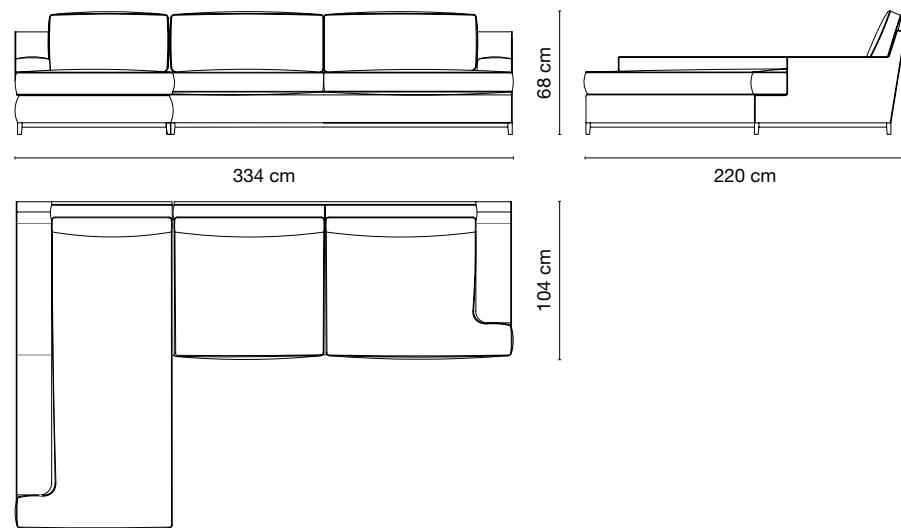

## TECHNICAL FEATURES

**Structure:** solid wood and plywood panels

**Seat and backrest:** padding in variable density high-resistance foam polyurethane / seat with elastic straps / non-removable cover

**Cushions:** goose down divided into sections with high-resistance foam polyurethane inset and polyester fiber lining / removable cover

**Base:** solid beech wood / solid walnut

**Piping:** gros grain

**Protective glides:** felt

Packaging	not assembled	cbm.	kg.
Standard	●	4,30	174
Pallet	●	5,10	*
Wooden crate	●	6,08	*

\* weight to be confirmed

HUG C11	Matt lacquered				Glossy lacquered				Matt walnut				Glossy walnut
	M001 M002 M003 M004 M005 M014	M006 M007 M011 M012 M013 M015 M018 M019	G001 G002 G003 G004 G005 G014	G006 G007 G011 G012 G013 G015 G018 G019	Natural Walnut NO.020.NA	Honey Walnut NO.020.MI	Tobacco Walnut NO.020.TA	Moro Walnut NO.020.MO	Tobacco Walnut NO.100.TA				
Customer's fabric mtl. 25,60	●	●	●	●	●	●	●	●	●				
Fabric cat. A	●	●	●	●	●	●	●	●	●				
Fabric cat. B	●	●	●	●	●	●	●	●	●				
Fabric cat. C	●	●	●	●	●	●	●	●	●				
Fabric cat. D	●	●	●	●	●	●	●	●	●				

 | GALLERY >

 | SOFAS >

 | FINISHES >

 | UPHOLSTERY >

Modular sofa 294x220 with SX chaise longue

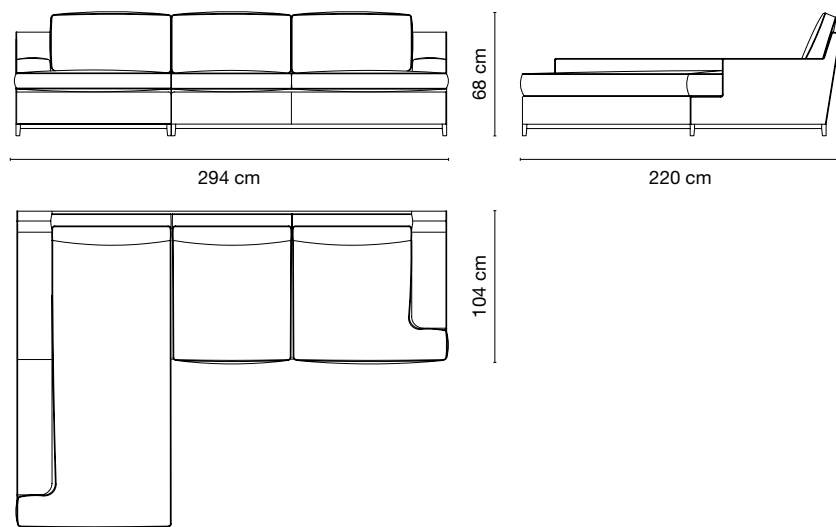
**TECHNICAL FEATURES****Structure:** solid wood and plywood panels**Seat and backrest:** padding in variable density high-resistance foam polyurethane / seat with elastic straps / non-removable cover**Cushions:** goose down divided into sections with high-resistance foam polyurethane inset and polyester fiber lining / removable cover**Base:** solid beech wood / solid walnut**Piping:** gros grain**Protective glides:** felt

Packaging	not assembled	cbm.	kg.
Standard	●	3,96	161
Pallet	●	4,72	*
Wooden crate	●	5,64	*

\* weight to be confirmed

HUG C22	Matt lacquered				Glossy lacquered				Matt walnut				Glossy walnut						
	M001 M004	M002 M005	M003 M014	M006 M013	M007 M015	M011 M018	M012 M019	G001 G004	G002 G005	G003 G014	G006 G013	G007 G015	G011 G018	G012 G019	Natural Walnut NO.020.NA	Honey Walnut NO.020.MI	Tobacco Walnut NO.020.TA	Moro Walnut NO.020.MO	Tobacco Walnut NO.100.TA
Customer's fabric mtl. 25,60	●			●				●			●			●			●		●
Fabric cat. A	●			●				●			●			●			●		●
Fabric cat. B	●			●				●			●			●			●		●
Fabric cat. C	●			●				●			●			●			●		●
Fabric cat. D	●			●				●			●			●			●		●

 | GALLERY >

 | SOFAS >

 | FINISHES >

 | UPHOLSTERY >

Modular sofa 294x220 with DX chaise longue

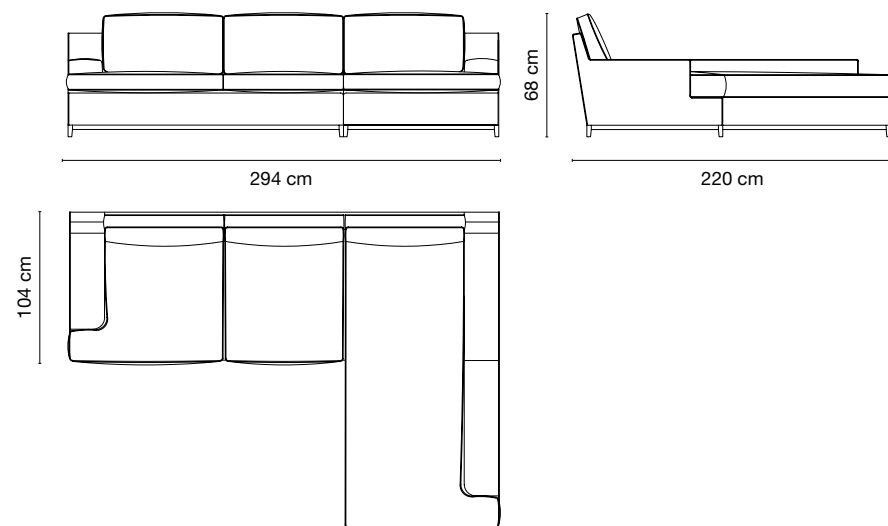
**TECHNICAL FEATURES****Structure:** solid wood and plywood panels**Seat and backrest:** padding in variable density high-resistance foam polyurethane / seat with elastic straps / non-removable cover**Cushions:** goose down divided into sections with high-resistance foam polyurethane inset and polyester fiber lining / removable cover**Base:** solid beech wood / solid walnut**Piping:** gros grain**Protective glides:** felt

Packaging	not assembled	cbm.	kg.
Standard	●	3,96	161
Pallet	●	4,72	*
Wooden crate	●	5,64	*

*\* weight to be confirmed*

HUG C33	Matt lacquered				Glossy lacquered				Matt walnut				Glossy walnut						
	M001 M004	M002 M005	M003 M014	M006 M013	M007 M015	M011 M018	M012 M019	G001 G004	G002 G005	G003 G014	G006 G013	G007 G015	G011 G018	G012 G019	Natural Walnut NO.020.NA	Honey Walnut NO.020.MI	Tobacco Walnut NO.020.TA	Moro Walnut NO.020.MO	Tobacco Walnut NO.100.TA
Customer's fabric mtl. 25,60	●			●				●			●			●			●		●
Fabric cat. A	●			●				●			●			●			●		●
Fabric cat. B	●			●				●			●			●			●		●
Fabric cat. C	●			●				●			●			●			●		●
Fabric cat. D	●			●				●			●			●			●		●

| GALLERY &gt;

| SOFAS &gt;

| FINISHES &gt;

| UPHOLSTERY &gt;

# HUGO | Studio Galimberti - 2017

Modular sofa 334x220 with DX chaise longue

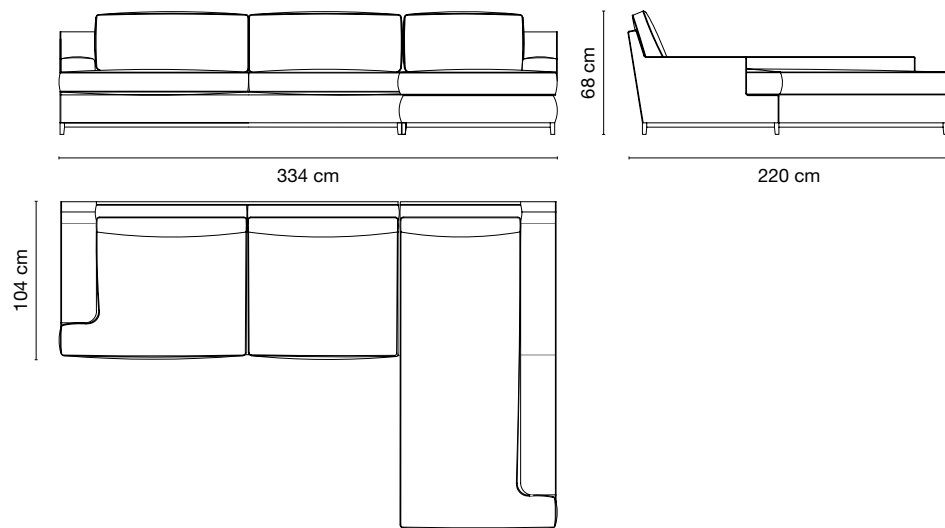

## TECHNICAL FEATURES

**Structure:** solid wood and plywood panels

**Seat and backrest:** padding in variable density high-resistance foam polyurethane / seat with elastic straps / non-removable cover

**Cushions:** goose down divided into sections with high-resistance foam polyurethane inset and polyester fiber lining / removable cover

**Base:** solid beech wood / solid walnut

**Piping:** gros grain

**Protective glides:** felt

Packaging	not assembled	cbm.	kg.
Standard	●	4,30	174
Pallet	●	5,10	*
Wooden crate	●	6,08	*

\* weight to be confirmed

HUG C44	Matt lacquered				Glossy lacquered				Matt walnut				Glossy walnut
	M001 M002 M003 M004 M005 M014	M006 M007 M011 M012 M013 M015 M018 M019	G001 G002 G003 G004 G005 G014	G006 G007 G011 G012 G013 G015 G018 G019	Natural Walnut NO.020.NA	Honey Walnut NO.020.MI	Tobacco Walnut NO.020.TA	Moro Walnut NO.020.MO	Tobacco Walnut NO.100.TA				
Customer's fabric mtl. 25,60	●	●	●	●	●	●	●	●	●				
Fabric cat. A	●	●	●	●	●	●	●	●	●				
Fabric cat. B	●	●	●	●	●	●	●	●	●				
Fabric cat. C	●	●	●	●	●	●	●	●	●				
Fabric cat. D	●	●	●	●	●	●	●	●	●				

 | GALLERY >

 | SOFAS >

 | FINISHES >

 | UPHOLSTERY >

Modular sofa 292x292

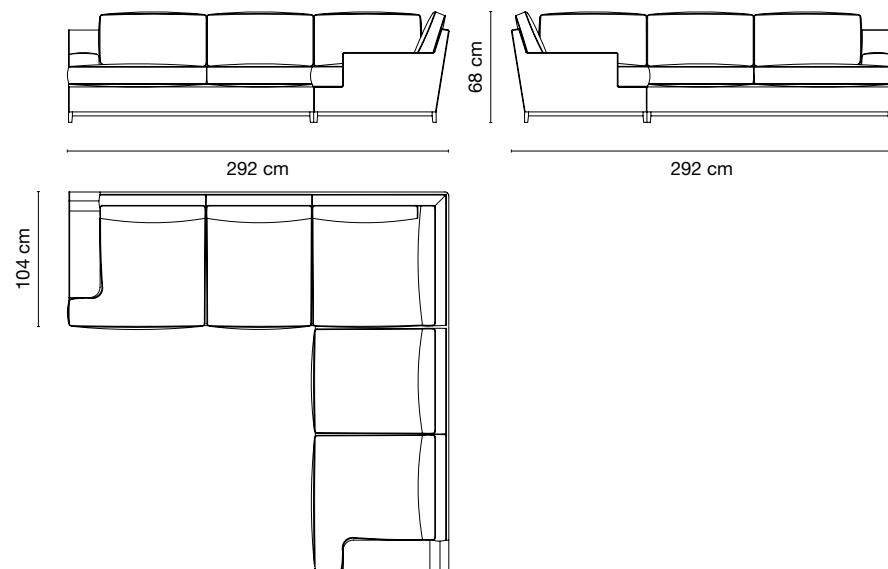
**TECHNICAL FEATURES****Structure:** solid wood and plywood panels**Seat and backrest:** padding in variable density high-resistance foam polyurethane / seat with elastic straps / non-removable cover**Cushions:** goose down divided into sections with high-resistance foam polyurethane inset and polyester fiber lining / removable cover**Base:** solid beech wood / solid walnut**Piping:** gros grain**Protective glides:** felt

Packaging	not assembled	cbm.	kg.
Standard	●	4,84	200
Pallet	●	5,74	*
Wooden crate	●	6,94	*

*\* weight to be confirmed*

HUG C66	Matt lacquered				Glossy lacquered				Matt walnut				Glossy walnut
	M001 M002 M003 M004 M005 M014	M006 M007 M011 M012 M013 M015 M018 M019	G001 G002 G003 G004 G005 G014	G006 G007 G011 G012 G013 G015 G018 G019	Natural Walnut NO.020.NA	Honey Walnut NO.020.MI	Tobacco Walnut NO.020.TA	Moro Walnut NO.020.MO	Tobacco Walnut NO.100.TA				
Customer's fabric mtl. 37,20	●	●	●	●	●	●	●	●	●				
Fabric cat. A	●	●	●	●	●	●	●	●	●				
Fabric cat. B	●	●	●	●	●	●	●	●	●				
Fabric cat. C	●	●	●	●	●	●	●	●	●				
Fabric cat. D	●	●	●	●	●	●	●	●	●				

 | GALLERY >

 | SOFAS >

 | FINISHES >

 | UPHOLSTERY >

## Modular sofa 292x332 DX

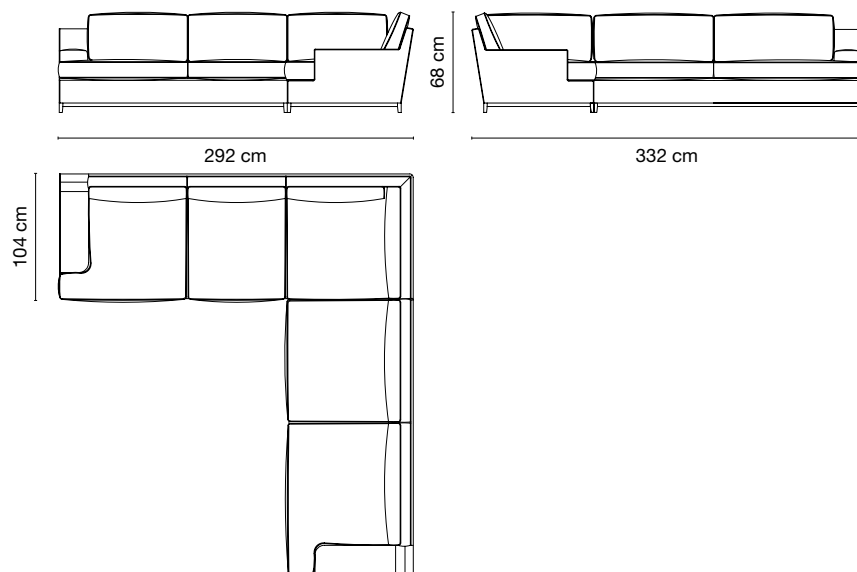
**TECHNICAL FEATURES****Structure:** solid wood and plywood panels**Seat and backrest:** padding in variable density high-resistance foam polyurethane / seat with elastic straps / non-removable cover**Cushions:** goose down divided into sections with high-resistance foam polyurethane inset and polyester fiber lining / removable cover**Base:** solid beech wood / solid walnut**Piping:** gros grain**Protective glides:** felt

Packaging	not assembled	cbm.	kg.
Standard	●	5,18	213
Pallet	●	6,12	*
Wooden crate	●	7,38	*

\* weight to be confirmed

HUG C77	Matt lacquered				Glossy lacquered				Matt walnut				Glossy walnut
	M001 M002 M003 M004 M005 M014	M006 M007 M011 M012 M013 M015 M018 M019	G001 G002 G003 G004 G005 G014	G006 G007 G011 G012 G013 G015 G018 G019	Natural Walnut NO.020.NA	Honey Walnut NO.020.MI	Tobacco Walnut NO.020.TA	Moro Walnut NO.020.MO	Tobacco Walnut NO.100.TA				
Customer's fabric mtl. 37,20	●	●	●	●	●	●	●	●	●				
Fabric cat. A	●	●	●	●	●	●	●	●	●				
Fabric cat. B	●	●	●	●	●	●	●	●	●				
Fabric cat. C	●	●	●	●	●	●	●	●	●				
Fabric cat. D	●	●	●	●	●	●	●	●	●				

| GALLERY &gt;

| SOFAS &gt;

| FINISHES &gt;

| UPHOLSTERY &gt;

## Modular sofa 292x332 SX

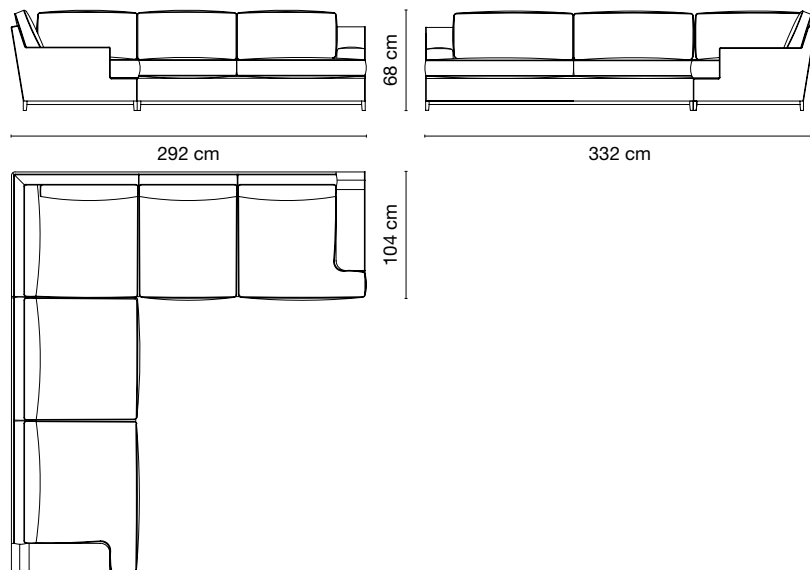
**TECHNICAL FEATURES****Structure:** solid wood and plywood panels**Seat and backrest:** padding in variable density high-resistance foam polyurethane / seat with elastic straps / non-removable cover**Cushions:** goose down divided into sections with high-resistance foam polyurethane inset and polyester fiber lining / removable cover**Base:** solid beech wood / solid walnut**Piping:** gros grain**Protective glides:** felt

Packaging	not assembled	cbm.	kg.
Standard	●	5,18	213
Pallet	●	6,12	*
Wooden crate	●	7,38	*

*\* weight to be confirmed*

HUG C88	Matt lacquered				Glossy lacquered				Matt walnut				Glossy walnut
	M001 M002 M003 M004 M005 M014	M006 M007 M011 M012 M013 M015 M018 M019	G001 G002 G003 G004 G005 G014	G006 G007 G011 G012 G013 G015 G018 G019	Natural Walnut NO.020.NA	Honey Walnut NO.020.MI	Tobacco Walnut NO.020.TA	Moro Walnut NO.020.MO	Tobacco Walnut NO.100.TA				
Customer's fabric mtl. 37,20	●	●	●	●	●	●	●	●	●				
Fabric cat. A	●	●	●	●	●	●	●	●	●				
Fabric cat. B	●	●	●	●	●	●	●	●	●				
Fabric cat. C	●	●	●	●	●	●	●	●	●				
Fabric cat. D	●	●	●	●	●	●	●	●	●				

 | GALLERY >

 | SOFAS >

 | FINISHES >

 | UPHOLSTERY >

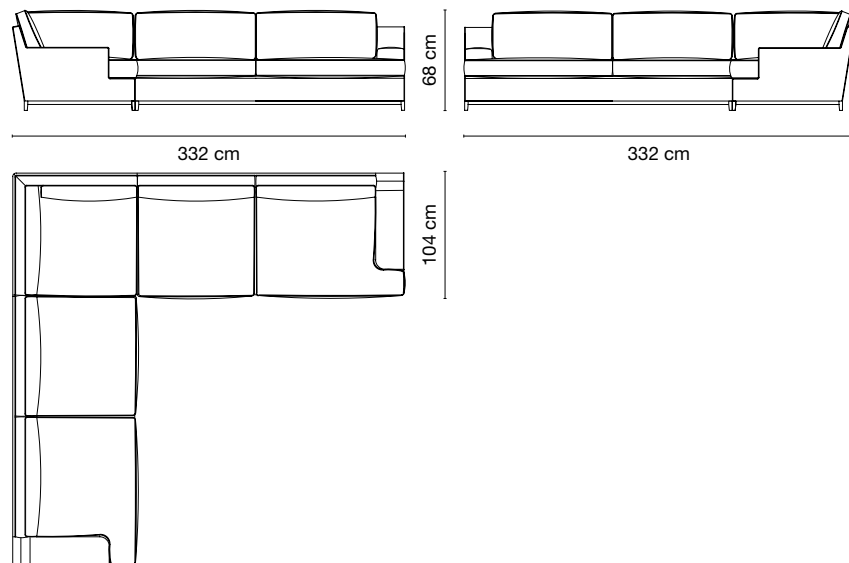

## Modular sofa 332x332

**TECHNICAL FEATURES****Structure:** solid wood and plywood panels**Seat and backrest:** padding in variable density high-resistance foam polyurethane / seat with elastic straps / non-removable cover**Cushions:** goose down divided into sections with high-resistance foam polyurethane inset and polyester fiber lining / removable cover**Base:** solid beech wood / solid walnut**Piping:** gros grain**Protective glides:** felt

Packaging	not assembled	cbm.	kg.
Standard	●	5,52	226
Pallet	●	6,50	*
Wooden crate	●	7,82	*

\* weight to be confirmed

HUG C99	Matt lacquered				Glossy lacquered				Matt walnut				Glossy walnut
	M001 M002 M003 M004 M005 M014	M006 M007 M011 M012 M013 M015 M018 M019	G001 G002 G003 G004 G005 G014	G006 G007 G011 G012 G013 G015 G018 G019	Natural Walnut NO.020.NA	Honey Walnut NO.020.MI	Tobacco Walnut NO.020.TA	Moro Walnut NO.020.MO	Tobacco Walnut NO.100.TA				
Customer's fabric mtl. 37,20	●	●	●	●	●	●	●	●	●				
Fabric cat. A	●	●	●	●	●	●	●	●	●				
Fabric cat. B	●	●	●	●	●	●	●	●	●				
Fabric cat. C	●	●	●	●	●	●	●	●	●				
Fabric cat. D	●	●	●	●	●	●	●	●	●				

| GALLERY &gt;

| SOFAS &gt;

| FINISHES &gt;

| UPHOLSTERY &gt;

### CHAISES LONGUES



The elegant silhouette of Hugo chaises longues and their comfortable structure are the distinctive traits of these pieces that invite to relax and entertain, providing ample seating space. The straight lines of the solid wood base, the soft cushions and minimalist accents make this collection a significant presence in any interior.

**Covers:** fabric

**Base finishes:** matt and glossy lacquer in the Galimberti Nino colour range / natural walnut / honey walnut / matt and glossy tobacco walnut / moro walnut

 | [VIEW ON WEBSITE](#) >

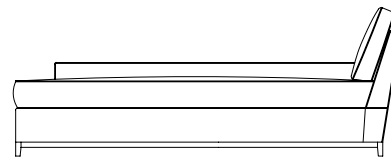

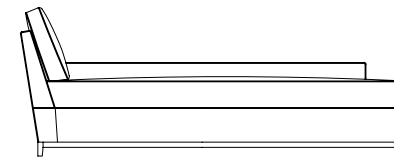

**HUG 40T**  
Chaise longue SX >





**HUG 41U**  
Chaise longue DX >



 | [GALLERY](#) >

 | [SOFAS](#) >

 | [FINISHES](#) >

 | [UPHOLSTERY](#) >

## Chaise longue SX

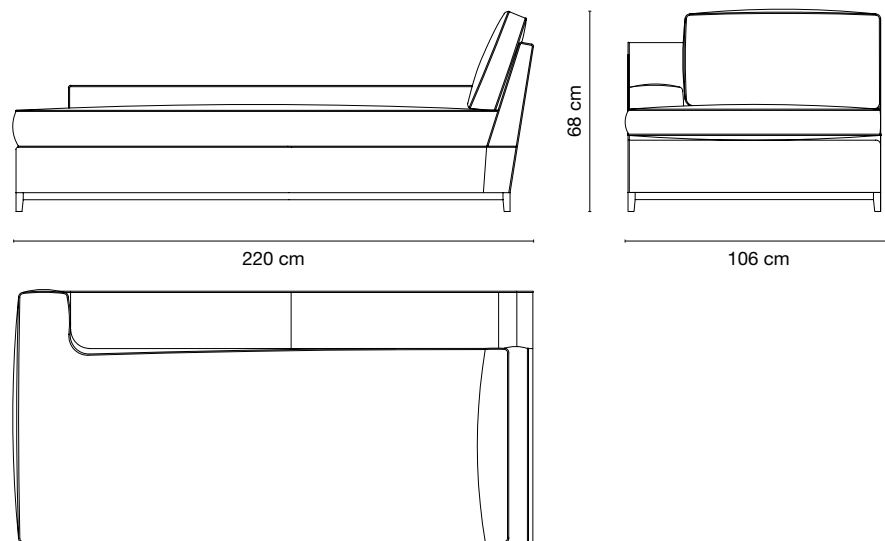
**TECHNICAL FEATURES****Structure:** solid wood and plywood panels**Seat and backrest:** padding in variable density high-resistance foam polyurethane / seat with elastic straps / non-removable cover**Cushions:** goose down divided into sections with high-resistance foam polyurethane inset and polyester fiber lining / removable cover**Base:** solid beech wood / solid walnut**Piping:** gros grain**Protective glides:** felt

Packaging	assembled	cbm.	kg.
Standard	●	2,12	84
Pallet	●	2,52	*
Wooden crate	●	3,00	*

\* weight to be confirmed

HUG 40T	Matt lacquered				Glossy lacquered				Matt walnut				Glossy walnut						
	M001 M004	M002 M005	M003 M014	M006 M013	M007 M015	M011 M018	M012 M019	G001 G004	G002 G005	G003 G014	G006 G013	G007 G015	G011 G018	G012 G019	Natural Walnut NO.020.NA	Honey Walnut NO.020.MI	Tobacco Walnut NO.020.TA	Moro Walnut NO.020.MO	Tobacco Walnut NO.100.TA
Customer's fabric mtl. 12,00	●			●				●			●			●			●		●
Fabric cat. A	●			●				●			●			●			●		●
Fabric cat. B	●			●				●			●			●			●		●
Fabric cat. C	●			●				●			●			●			●		●
Fabric cat. D	●			●				●			●			●			●		●

| GALLERY &gt;

| SOFAS &gt;

| FINISHES &gt;

| UPHOLSTERY &gt;

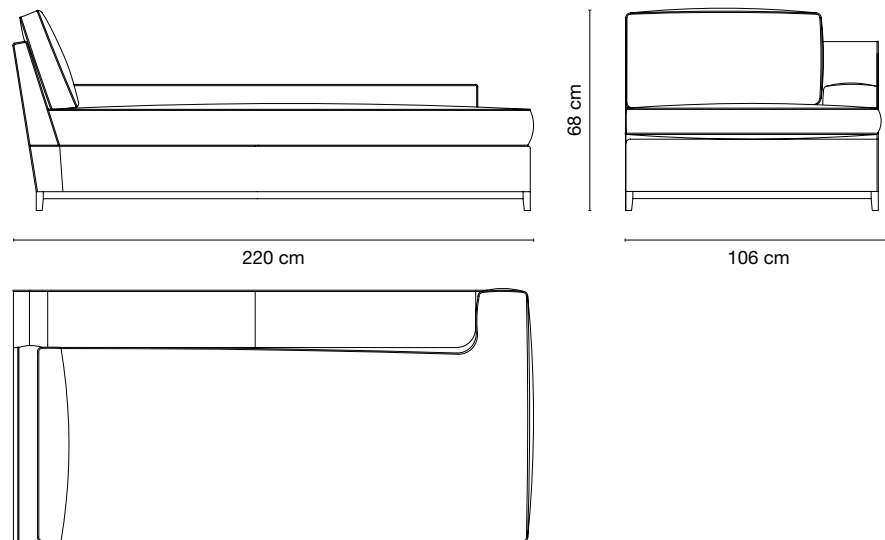

## Chaise longue DX

**TECHNICAL FEATURES****Structure:** solid wood and plywood panels**Seat and backrest:** padding in variable density high-resistance foam polyurethane / seat with elastic straps / non-removable cover**Cushions:** goose down divided into sections with high-resistance foam polyurethane inset and polyester fiber lining / removable cover**Base:** solid beech wood / solid walnut**Piping:** gros grain**Protective glides:** felt

Packaging	assembled	cbm.	kg.
Standard	●	2,12	84
Pallet	●	2,52	*
Wooden crate	●	3,00	*

\* weight to be confirmed

HUG 41U	Matt lacquered				Glossy lacquered				Matt walnut				Glossy walnut
	M001 M002 M003 M004 M005 M014	M006 M007 M011 M012 M013 M015 M018 M019	G001 G002 G003 G004 G005 G014	G006 G007 G011 G012 G013 G015 G018 G019	Natural Walnut NO.020.NA	Honey Walnut NO.020.MI	Tobacco Walnut NO.020.TA	Moro Walnut NO.020.MO	Tobacco Walnut NO.100.TA				
Customer's fabric mtl. 12,00	●	●	●	●	●	●	●	●	●				
Fabric cat. A	●	●	●	●	●	●	●	●	●				
Fabric cat. B	●	●	●	●	●	●	●	●	●				
Fabric cat. C	●	●	●	●	●	●	●	●	●				
Fabric cat. D	●	●	●	●	●	●	●	●	●				

| GALLERY &gt;

| SOFAS &gt;

| FINISHES &gt;

| UPHOLSTERY &gt;

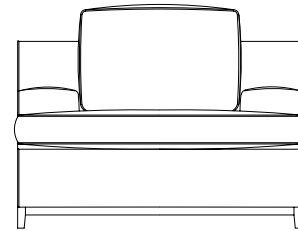

**HUG 21A**  
Club chair

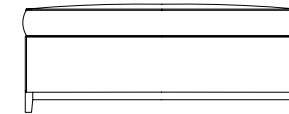

**HUG 42Z**  
Ottoman



The elegant silhouette of Hugo club chair and ottoman and their comfortable structure are the distinctive traits of these pieces that invite to relax and entertain, providing ample seating space. The straight lines of the solid wood base, the soft cushions and minimalist accents make this collection a significant presence in any interior.

**Covers:** fabric

**Base finishes:** matt and glossy lacquer in the Galimberti Nino colour range / natural walnut / honey walnut / matt and glossy tobacco walnut / moro walnut



[VIEW ON WEBSITE](#)



[GALLERY](#)



[ARMCHAIRS  
AND OTTOMANS](#)



[FINISHES](#)



[UPHOLSTERY](#)

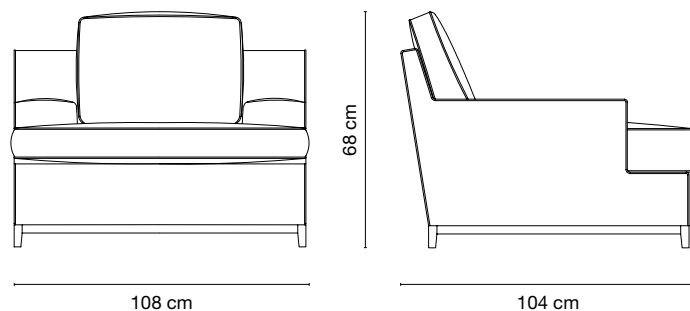

## Club chair

**TECHNICAL FEATURES****Structure:** solid wood and plywood panels**Seat and backrest:** padding in variable density high-resistance foam polyurethane / seat with elastic straps / non-removable cover**Cushions:** goose down divided into sections with high-resistance foam polyurethane inset and polyester fiber lining / removable cover**Base:** solid beech wood / solid walnut**Piping:** gros grain**Protective glides:** felt

Packaging	assembled	cbm.	kg.
Standard	●	1,12	49
Pallet	●	1,32	*
Wooden crate	●	1,64	*

\* weight to be confirmed

HUG 21A	Matt lacquered				Glossy lacquered				Matt walnut				Glossy walnut						
	M001 M004	M002 M005	M003 M014	M006 M013	M007 M015	M011 M018	M012 M019	G001 G004	G002 G005	G003 G014	G006 G013	G007 G015	G011 G018	G012 G019	Natural Walnut NO.020.NA	Honey Walnut NO.020.MI	Tobacco Walnut NO.020.TA	Moro Walnut NO.020.MO	Tobacco Walnut NO.100.TA
Customer's fabric mtl. 7,00	●			●				●			●			●	●	●	●	●	●
Fabric cat. A	●			●				●			●			●	●	●	●	●	●
Fabric cat. B	●			●				●			●			●	●	●	●	●	●
Fabric cat. C	●			●				●			●			●	●	●	●	●	●
Fabric cat. D	●			●				●			●			●	●	●	●	●	●

| GALLERY &gt;

| ARMCHAIRS AND OTTOMANS &gt;

| FINISHES &gt;

| UPHOLSTERY &gt;

## Ottoman

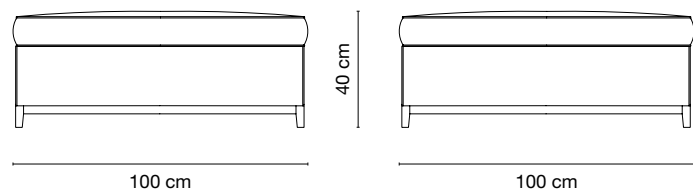

## TECHNICAL FEATURES

**Structure:** solid wood and plywood panels

**Seat:** padding in variable density high-resistance foam polyurethane / seat with elastic straps / non-removable cover

**Cushion:** goose down divided into sections with high-resistance foam polyurethane inset and polyester fiber lining / removable cover

**Base:** solid beech wood / solid walnut

**Piping:** gros grain

**Protective glides:** felt

Packaging	assembled	cbm.	kg.
Standard	●	0,62	30
Pallet	●	0,80	*
Wooden crate	●	1,02	*

\* weight to be confirmed

HUG 42Z	Matt lacquered				Glossy lacquered				Matt walnut				Glossy walnut
	M001 M002 M003 M004 M005 M014	M006 M007 M011 M012 M013 M015 M018 M019	G001 G002 G003 G004 G005 G014	G006 G007 G011 G012 G013 G015 G018 G019	Natural Walnut NO.020.NA	Honey Walnut NO.020.MI	Tobacco Walnut NO.020.TA	Moro Walnut NO.020.MO	Tobacco Walnut NO.100.TA				
Customer's fabric mtl. 5,50	●	●	●	●	●	●	●	●	●				
Fabric cat. A	●	●	●	●	●	●	●	●	●				
Fabric cat. B	●	●	●	●	●	●	●	●	●				
Fabric cat. C	●	●	●	●	●	●	●	●	●				
Fabric cat. D	●	●	●	●	●	●	●	●	●				

 | GALLERY >

 | ARMCHAIRS AND OTTOMANS >

 | FINISHES >

 | UPHOLSTERY >



The bed with its sober shape and strong character will perfectly suite both modern and classic bedrooms. The wooden base and the padded structure with the quilted headboard, enriched with the buffalo horn buttons, create the play of contrasts of materials to add sophisticated touch to this piece.

**Covers:** fabric / leather

**Structure finishes:** matt and glossy lacquer in the Galimberti Nino colour range

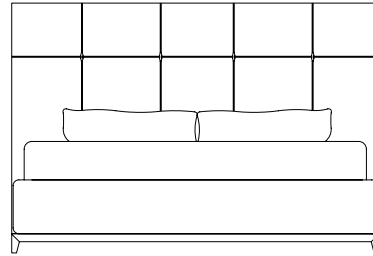

**JAC 01A**  
Bed 180

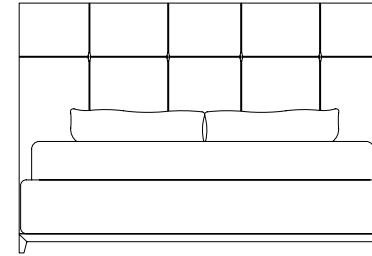

**JAC 03C**  
Storage bed 180

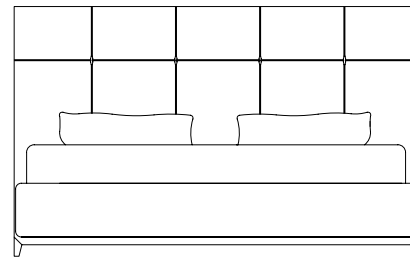

**JAC 02B**  
Bed 200



VIEW ON WEBSITE



GALLERY



BEDS



FINISHES



UPHOLSTERY



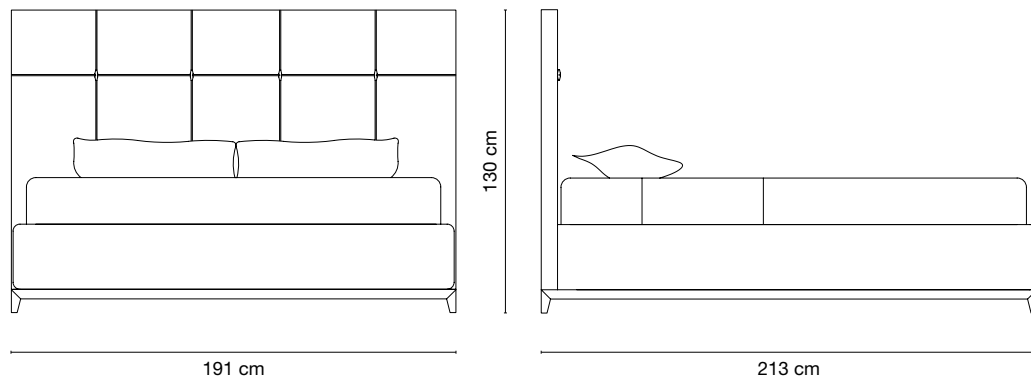

## Bed 180

**TECHNICAL FEATURES****Structure:** plywood, honeycomb MDF and chipboard panels**Base:** solid toulipier wood**Headboard, footboard and sides:** padding in variable density high-resistance foam polyurethane / non-removable cover / buffalo's horn buttons**Mattress' support:** metal bed frame with wooden slats**Protective glides:** felt**Mattress (not included):** size 180 x 200 x h.22 cm

Cushions and bed set not included

Packaging	not assembled	cbm.	kg.
Standard	●	0,98	125
Wooden crate**	●	1,70	*

\* weight to be confirmed \*\* slatted base not included

JAC 01A	Matt lacquered				Glossy lacquered			
	M001 M002 M003 M004 M005 M014	M006 M007 M011 M012 M013 M015 M018 M019	G001 G002 G003 G004 G005 G014	G006 G007 G011 G012 G013 G015 G018 G019				
Customer's fabric mtl. 6,50	●	●	●	●				
Fabric cat. A	●	●	●	●				
Fabric cat. B	●	●	●	●				
Fabric cat. C	●	●	●	●				
Fabric cat. D	●	●	●	●				
Leather	●	●	●	●				
Leather Lux	●	●	●	●				



| GALLERY &gt;

| BEDS &gt;

| FINISHES &gt;

| UPHOLSTERY &gt;

## Storage bed 180

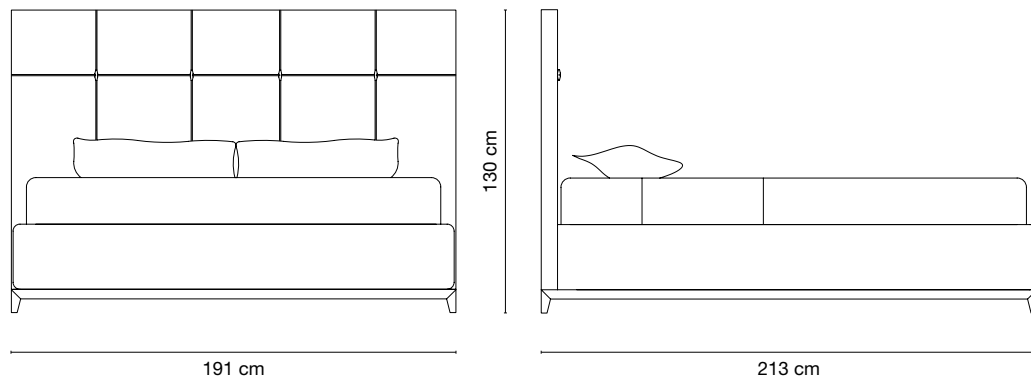

## TECHNICAL FEATURES

**Structure:** plywood, honeycomb MDF and chipboard panels

**Base:** solid toulipier wood

**Headboard, footboard and sides:** padding in variable density high-resistance foam polyurethane / non-removable cover / buffalo's horn buttons

**Mattress' support:** metal bed frame with wooden slats and bed lift mechanism with full opening and horizontal stabilizer (mattress max. 45 kg)

**Protective glides:** felt

**Mattress (not included):** size 180 x 200 x h.22 cm

Cushions and bed set not included

Packaging	not assembled	cbm.	kg.
Standard	●	1,16	172
Wooden crate**	●	2,02	*

\* weight to be confirmed \*\* slatted base not included

JAC 03C	Matt lacquered				Glossy lacquered			
	M001 M002 M003 M004 M005 M014	M006 M007 M011 M012 M013 M015 M018 M019	G001 G002 G003 G004 G005 G014	G006 G007 G011 G012 G013 G015 G018 G019				
Customer's fabric mtl. 6,50	●	●	●	●				
Fabric cat. A	●	●	●	●				
Fabric cat. B	●	●	●	●				
Fabric cat. C	●	●	●	●				
Fabric cat. D	●	●	●	●				
Leather	●	●	●	●				
Leather Lux	●	●	●	●				



| GALLERY >

| BEDS >

| FINISHES >

| UPHOLSTERY >

## Bed 200

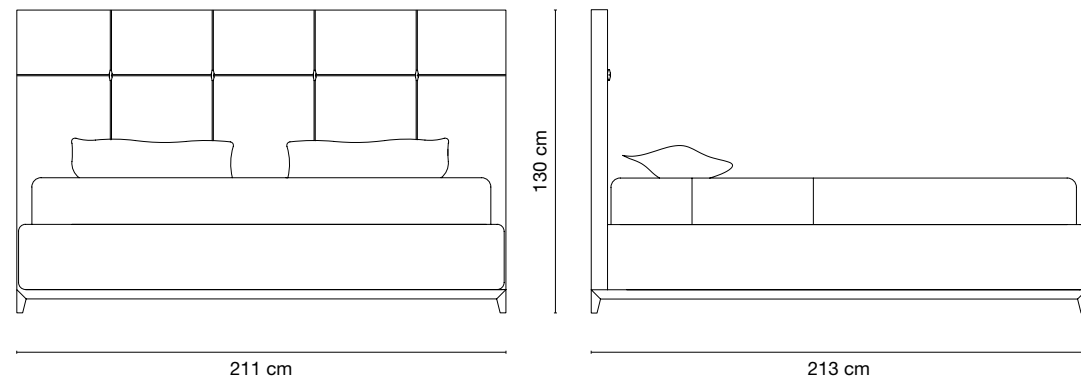
**TECHNICAL FEATURES****Structure:** plywood, honeycomb MDF and chipboard panels**Base:** solid toulipier wood**Headboard, footboard and sides:** padding in variable density high-resistance foam polyurethane / non-removable cover / buffalo's horn buttons**Mattress' support:** metal bed frame with wooden slats**Protective glides:** felt**Mattress (not included):** size 200 x 200 x h.22 cm

Cushions and bed set not included

Packaging	not assembled	cbm.	kg.
Standard	●	1,04	142
Wooden crate**	●	1,80	*

\* weight to be confirmed \*\* slatted base not included

JAC 02B	Matt lacquered				Glossy lacquered			
	M001 M002 M003 M004 M005 M014	M006 M007 M011 M012 M013 M015 M018 M019	G001 G002 G003 G004 G005 G014	G006 G007 G011 G012 G013 G015 G018 G019				
Customer's fabric mtl. 7,00	●	●	●	●				
Fabric cat. A	●	●	●	●				
Fabric cat. B	●	●	●	●				
Fabric cat. C	●	●	●	●				
Fabric cat. D	●	●	●	●				
Leather	●	●	●	●				
Leather Lux	●	●	●	●				



| GALLERY &gt;

| BEDS &gt;

| FINISHES &gt;

| UPHOLSTERY &gt;

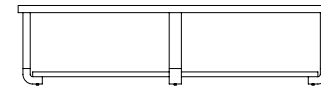

**JCQ 63B**  
Coffee table

The charming cut-out silhouette of this coffee table gives it a light and airy look, making it a statement piece in a contemporary or modern interior. Metal inserts add a surprising textural contrast with the round upper and lower tops, for a refined final effect.

**Tops and structure finishes:** natural walnut / honey walnut / matt and glossy tobacco walnut / matt and glossy moro walnut

**Metal insets finishes:** matt black

 | [VIEW ON WEBSITE](#) >

 | [GALLERY](#) >

 | [COFFEE AND SIDE TABLES](#) >

 | [FINISHES](#) >

 | [UPHOLSTERY](#) >

Coffee table

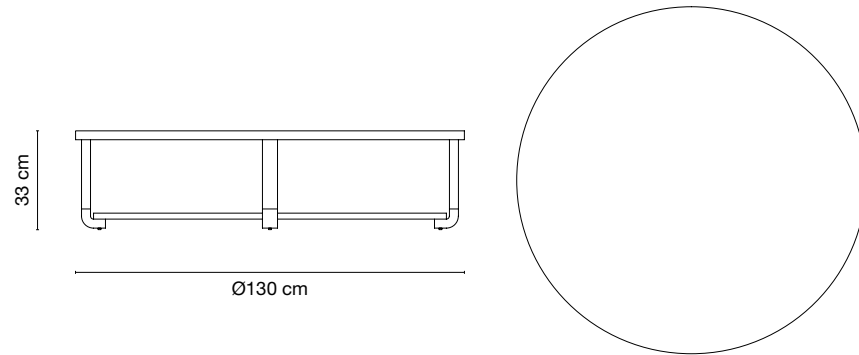
**TECHNICAL FEATURES****Top:** chipboard panels covered with walnut wood veneer**Structure:** solid walnut**Insets:** painted metal**Protective glides:** soft non-scratch rubber

Packaging	assembled	cbm.	kg.
Standard	●	0,74	38
Pallet	●	1,02	*
Wooden crate	●	1,28	*

\* weight to be confirmed

JCQ 63B	Matt walnut				Glossy walnut
	Natural Walnut NO.020.NA	Honey Walnut NO.020.MI	Tobacco Walnut NO.020.TA	Moro Walnut NO.020.MO	Tobacco Walnut NO.100.TA
	●	●	●	●	●



| GALLERY &gt;

| COFFEE AND SIDE TABLES &gt;

| FINISHES &gt;

| UPHOLSTERY &gt;



A striking addition to both classical or eclectic interiors, this sophisticated bed exudes a classic and romantic flair due to the shaped silhouette of the padded headboard, lending this piece a timeless charm.

**Covers:** fabric

**Structure finishes:** matt and glossy lacquer in the Galimberti Nino colour range

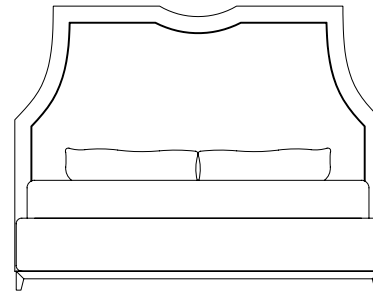

**JOL 21A**  
Bed 180

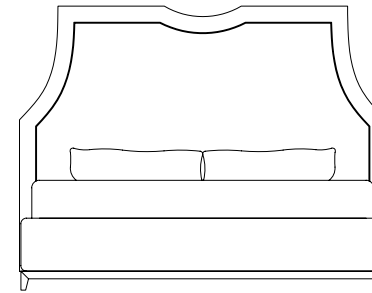

**JOL 23C**  
Storage bed 180

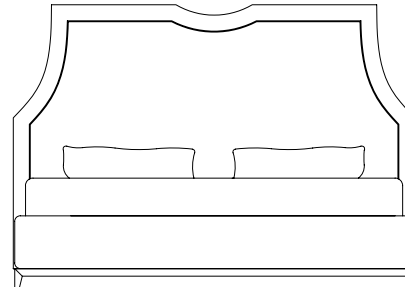

**JOL 22B**  
Bed 200



VIEW ON WEBSITE



GALLERY



BEDS



FINISHES



UPHOLSTERY

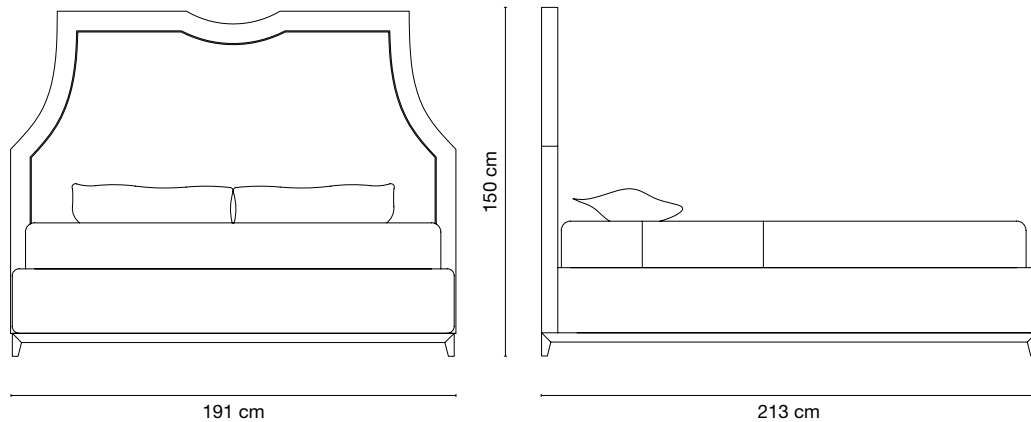

## Bed 180

**TECHNICAL FEATURES****Structure:** plywood, honeycomb MDF and chipboard panels**Base:** solid toulipier wood**Headboard, footboard and sides:** padding in variable density high-resistance foam polyurethane / non-removable cover**Piping:** gros grain**Mattress' support:** metal bed frame with wooden slats**Protective glides:** felt**Mattress (not included):** size 180 x 200 x h.22 cm

Cushions and bed set not included

Packaging	not assembled	cbm.	kg.
Standard	●	1,04	135
Wooden crate**	●	1,80	*

\* weight to be confirmed \*\* slatted base not included

JOL 21A	Matt lacquered				Glossy lacquered			
	M001 M002 M003 M004 M005 M014	M006 M007 M011 M012 M013 M015 M018 M019	G001 G002 G003 G004 G005 G014	G006 G007 G011 G012 G013 G015 G018 G019				
Customer's fabric mtl. 7,20	●	●	●	●				
Fabric cat. A	●	●	●	●				
Fabric cat. B	●	●	●	●				
Fabric cat. C	●	●	●	●				
Fabric cat. D	●	●	●	●				



| GALLERY &gt;

| BEDS &gt;

| FINISHES &gt;

| UPHOLSTERY &gt;

## Storage bed 180

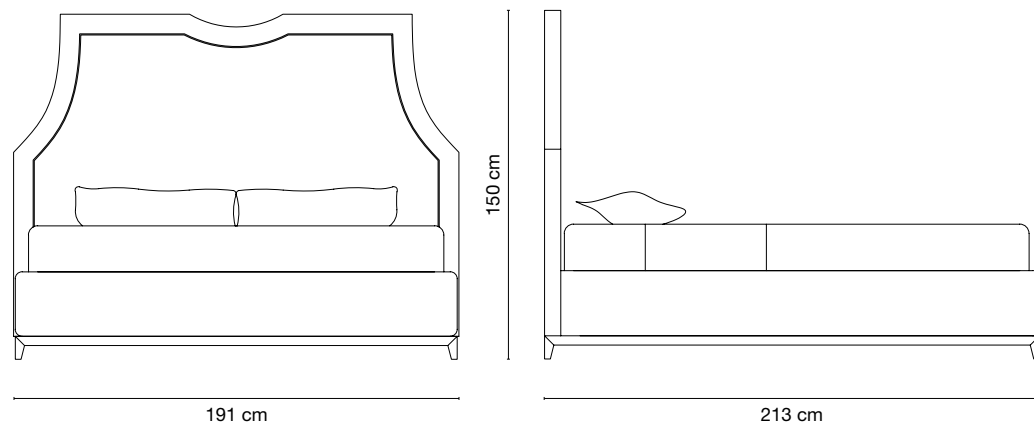
**TECHNICAL FEATURES****Structure:** plywood, honeycomb MDF and chipboard panels**Base:** solid toulipier wood**Headboard, footboard and sides:** padding in variable density high-resistance foam polyurethane / non-removable cover**Piping:** gros grain**Mattress' support:** metal bed frame with wooden slats and bed lift mechanism with full opening and horizontal stabilizer (mattress max. 45 kg)**Protective glides:** felt**Mattress (not included):** size 180 x 200 x h.22 cm

Cushions and bed set not included

Packaging	not assembled	cbm.	kg.
Standard	●	1,22	182
Wooden crate**	●	2,12	*

\* weight to be confirmed \*\* slatted base not included

JOL 23C	Matt lacquered				Glossy lacquered			
	M001 M002 M003 M004 M005 M014	M006 M007 M011 M012 M013 M015 M018 M019	G001 G002 G003 G004 G005 G014	G006 G007 G011 G012 G013 G015 G018 G019				
Customer's fabric mtl. 7,20	●	●	●	●				
Fabric cat. A	●	●	●	●				
Fabric cat. B	●	●	●	●				
Fabric cat. C	●	●	●	●				
Fabric cat. D	●	●	●	●				



| GALLERY &gt;

| BEDS &gt;

| FINISHES &gt;

| UPHOLSTERY &gt;

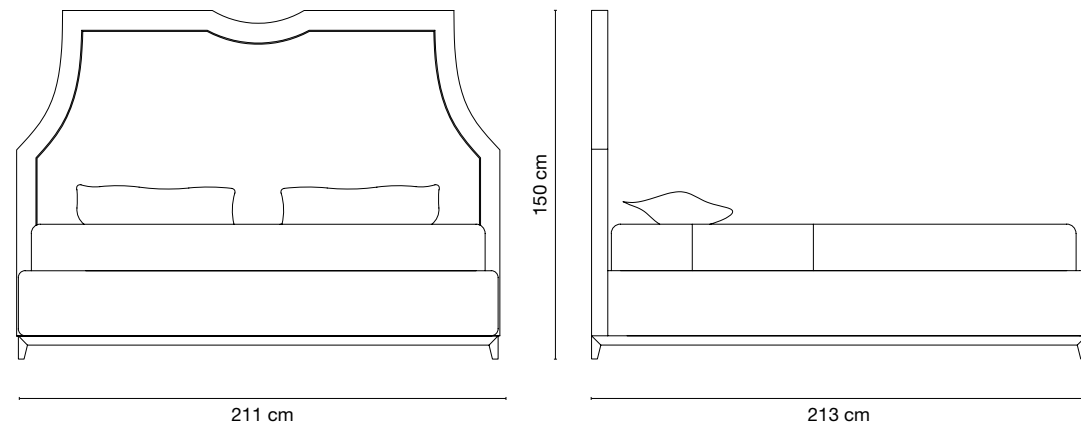

## Bed 200

**TECHNICAL FEATURES****Structure:** plywood, honeycomb MDF and chipboard panels**Base:** solid toulipier wood**Headboard, footboard and sides:** padding in variable density high-resistance foam polyurethane / non-removable cover**Piping:** gros grain**Mattress' support:** metal bed frame with wooden slats**Protective glides:** felt**Mattress (not included):** size 200 x 200 x h.22 cm

Cushions and bed set not included

Packaging	not assembled	cbm.	kg.
Standard	●	1,10	152
Wooden crate**	●	1,92	*

\* weight to be confirmed \*\* slatted base not included

JOL 22B	Matt lacquered				Glossy lacquered			
	M001 M002 M003 M004 M005 M014	M006 M007 M011 M012 M013 M015 M018 M019	G001 G002 G003 G004 G005 G014	G006 G007 G011 G012 G013 G015 G018 G019				
Customer's fabric mtl. 7,60	●	●	●	●				
Fabric cat. A	●	●	●	●				
Fabric cat. B	●	●	●	●				
Fabric cat. C	●	●	●	●				
Fabric cat. D	●	●	●	●				



| GALLERY &gt;

| BEDS &gt;

| FINISHES &gt;

| UPHOLSTERY &gt;

## JULIETTE | Studio Galimberti - 2011

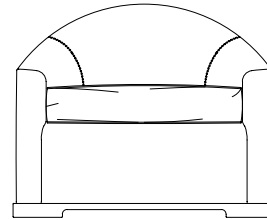

**JUL 01A**  
Club chair

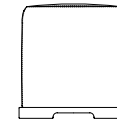

**JUL 36F**  
Small ottoman



Elegance and comfort blend with the contemporary, curved, soft and essential lines of the Juliette club chair and ottoman, giving the origin to a perfectly balanced design full of harmony. Its timeless charm and inviting padded structure are highlighted by the linear base in solid wood, minimalist but at the same time characterized by a impressive and surprising visual impact.

**Covers:** fabric / leather

**Structure finishes:** matt and glossy lacquer in the Galimberti Nino colour range / natural walnut / honey walnut / matt and glossy tobacco walnut / moro walnut

 | [VIEW ON WEBSITE](#)



 | [GALLERY](#)



 | [ARMCHAIRS AND OTTOMANS](#)



 | [FINISHES](#)



 | [UPHOLSTERY](#)



# JULIETTE

 | Studio Galimberti - 2011

Club chair

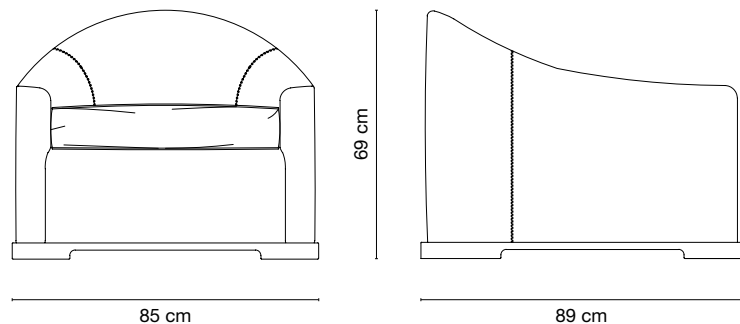
**TECHNICAL FEATURES****Structure:** solid wood and plywood panels**Seat and backrest:** padding in variable density high-resistance foam polyurethane / seat with elastic straps / non-removable cover**Cushion:** goose down divided into sections with high-resistance foam polyurethane inset / removable cover**Base:** solid beech wood / solid walnut**Piping:** gros grain**Protective glides:** felt

Packaging	assembled	cbm.	kg.
Standard	●	0,66	40
Pallet	●	0,78	*
Wooden crate	●	1,00	*

\* weight to be confirmed

JUL 01A	Matt lacquered				Glossy lacquered				Matt walnut				Glossy walnut
	M001 M002 M003 M004 M005 M014	M006 M007 M011 M012 M013 M015 M018 M019	G001 G002 G003 G004 G005 G014	G006 G007 G011 G012 G013 G015 G018 G019	Natural Walnut NO.020.NA	Honey Walnut NO.020.MI	Tobacco Walnut NO.020.TA	Moro Walnut NO.020.MO	Tobacco Walnut NO.100.TA				
Customer's fabric mtl. 4,50	●	●	●	●	●	●	●	●	●				
Fabric cat. A	●	●	●	●	●	●	●	●	●				
Fabric cat. B	●	●	●	●	●	●	●	●	●				
Fabric cat. C	●	●	●	●	●	●	●	●	●				
Fabric cat. D	●	●	●	●	●	●	●	●	●				
Leather	●	●	●	●	●	●	●	●	●				
Leather Lux	●	●	●	●	●	●	●	●	●				

| GALLERY &gt;

| ARMCHAIRS AND OTTOMANS &gt;

| FINISHES &gt;

| UPHOLSTERY &gt;

# JULIETTE

 | Studio Galimberti - 2011

Small ottoman

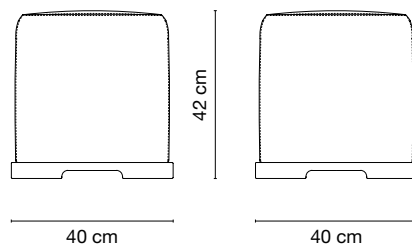
**TECHNICAL FEATURES****Structure:** solid wood and plywood panels**Seat:** padding in variable density high-resistance foam polyurethane / seat with elastic straps / non-removable cover**Base:** solid beech wood / solid walnut**Piping:** gros grain**Protective glides:** felt

Packaging	assembled	cbm.	kg.
Standard	•	0,10	9
Wooden crate	•	0,20	*

\* weight to be confirmed

JUL 36F	Matt lacquered				Glossy lacquered				Matt walnut				Glossy walnut
	M001 M002 M003 M004 M005 M014	M006 M007 M011 M012 M013 M015 M018 M019	G001 G002 G003 G004 G005 G014	G006 G007 G011 G012 G013 G015 G018 G019	Natural Walnut NO.020.NA	Honey Walnut NO.020.MI	Tobacco Walnut NO.020.TA	Moro Walnut NO.020.MO	Tobacco Walnut NO.100.TA				
Customer's fabric mtl. 1,00	•	•	•	•	•	•	•	•	•				
Fabric cat. A	•	•	•	•	•	•	•	•	•				
Fabric cat. B	•	•	•	•	•	•	•	•	•				
Fabric cat. C	•	•	•	•	•	•	•	•	•				
Fabric cat. D	•	•	•	•	•	•	•	•	•				
Leather	•	•	•	•	•	•	•	•	•				
Leather Lux	•	•	•	•	•	•	•	•	•				

| GALLERY &gt;

| ARMCHAIRS AND OTTOMANS &gt;

| FINISHES &gt;

| UPHOLSTERY &gt;

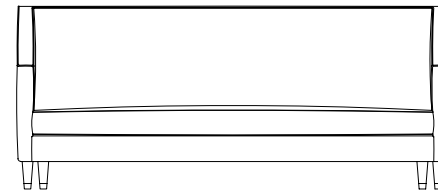

**KEL 01A**  
Sofa

Perfectly proportioned and exquisitely detailed, Kelly sofa will take center stage in any living room with its streamlined and refined silhouette. Defined by a generous seat, squared back, and flared armrests, this stunning piece of furniture is supported by six elegant feet with brass ferrules which add the sophisticated and precious accent.

**Covers:** fabric

**Legs finishes:** matt and glossy lacquer in the Galimberti Nino colour range / natural walnut / honey walnut / matt and glossy tobacco walnut / moro walnut

**Legs ferrules:** bronze painted / satin brass

 | [VIEW ON WEBSITE](#) >

 | [GALLERY](#) >

 | [SOFAS](#) >

 | [FINISHES](#) >

 | [UPHOLSTERY](#) >

## Sofa

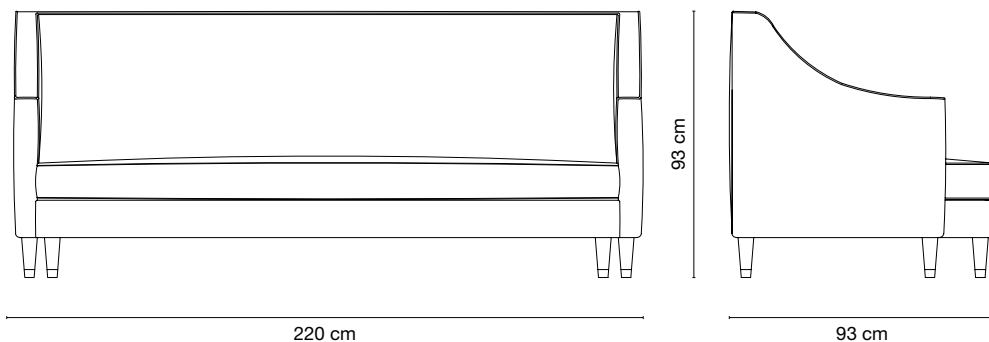
**TECHNICAL FEATURES**

**Structure:** solid wood and plywood panels

**Seat and backrest:** padding in variable density high-resistance foam polyurethane / seat with elastic straps / non-removable cover

**Cushion:** variable density high-resistance foam polyurethane and polyester fiber lining / removable cover

**Legs:** solid beech wood / solid walnut

**Legs ferrules:** brass

**Piping:** gros grain

**Protective glides:** felt

Packaging	assembled	cbm.	kg.	not assembled	cbm.	kg.
Standard	●	2,48	87	●	2,10	87
Pallet	●	2,84	*	●	2,48	*
Wooden crate	●	3,40	*	●	2,96	*

\* weight to be confirmed

KEL 01A	Matt lacquered				Glossy lacquered				Matt walnut				Glossy walnut
	M001 M002 M003 M004 M005 M014	M006 M007 M011 M012 M013 M015 M018 M019	G001 G002 G003 G004 G005 G014	G006 G007 G011 G012 G013 G015 G018 G019	Natural Walnut NO.020.NA	Honey Walnut NO.020.MI	Tobacco Walnut NO.020.TA	Moro Walnut NO.020.MO	Tobacco Walnut NO.100.TA				
Customer's fabric mtl. 11,00	●	●	●	●	●	●	●	●	●				
Fabric cat. A	●	●	●	●	●	●	●	●	●				
Fabric cat. B	●	●	●	●	●	●	●	●	●				
Fabric cat. C	●	●	●	●	●	●	●	●	●				
Fabric cat. D	●	●	●	●	●	●	●	●	●				

 | GALLERY >

 | SOFAS >

 | FINISHES >

 | UPHOLSTERY >

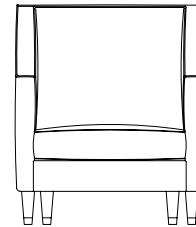

**KEL 02B**  
Club chair

Perfectly proportioned and exquisitely detailed, Kelly club chair will take center stage in any living room with its streamlined and refined silhouette. Defined by a generous seat, squared back, and flared armrests, this stunning piece of furniture is supported by six elegant feet with brass ferrules which add the sophisticated and precious accent.

**Covers:** fabric

**Legs finishes:** matt and glossy lacquer in the Galimberti Nino colour range / natural walnut / honey walnut / matt and glossy tobacco walnut / moro walnut

**Legs ferrules:** bronze painted / satin brass

 | [VIEW ON WEBSITE](#) >

 | [GALLERY](#) >

 | [ARMCHAIRS AND OTTOMANS](#) >

 | [FINISHES](#) >

 | [UPHOLSTERY](#) >

## Club chair

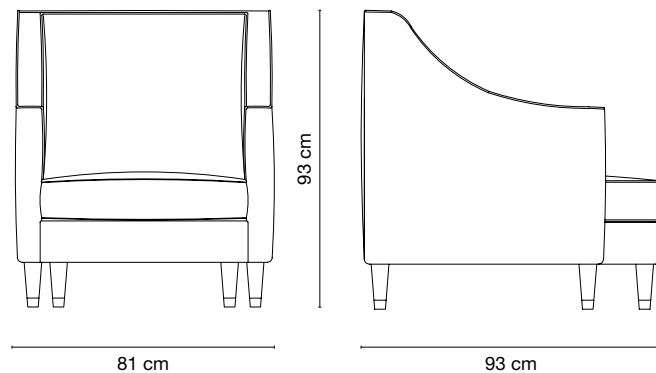

## TECHNICAL FEATURES

**Structure:** solid wood and plywood panels

**Seat and backrest:** padding in variable density high-resistance foam polyurethane / seat with elastic straps / non-removable cover

**Cushion:** variable density high-resistance foam polyurethane and polyester fiber lining / removable cover

**Legs:** solid beech wood / solid walnut

**Legs ferrules:** brass

**Piping:** gros grain

**Protective glides:** felt

Packaging	assembled	cbm.	kg.	not assembled	cbm.	kg.
Standard	●	0,96	40	●	0,82	40
Pallet	●	1,10	*	●	0,96	*
Wooden crate	●	1,38	*	●	1,22	*

\* weight to be confirmed

KEL 02B	Matt lacquered				Glossy lacquered				Matt walnut				Glossy walnut
	M001 M002 M003 M004 M005 M014	M006 M007 M011 M012 M013 M015 M018 M019	G001 G002 G003 G004 G005 G014	G006 G007 G011 G012 G013 G015 G018 G019	Natural Walnut NO.020.NA	Honey Walnut NO.020.MI	Tobacco Walnut NO.020.TA	Moro Walnut NO.020.MO	Tobacco Walnut NO.100.TA				
Customer's fabric mtl. 6,50	●	●	●	●	●	●	●	●	●				
Fabric cat. A	●	●	●	●	●	●	●	●	●				
Fabric cat. B	●	●	●	●	●	●	●	●	●				
Fabric cat. C	●	●	●	●	●	●	●	●	●				
Fabric cat. D	●	●	●	●	●	●	●	●	●				

| GALLERY >

| ARMCHAIRS AND OTTOMANS >

| FINISHES >

| UPHOLSTERY >





This elegant piece is an ideal bed to add comfort and a decorative and exclusive look to any bedroom. Its welcoming silhouette is distinctive for the harmonious design and softness of its headboard as well as the absence of any sharp corner. In retro style, this bed, supported by six elegant feet with brass ferrules that add the refined and precious touch, will be ideal to relax and to sleep.

**Covers:** fabric

**Legs finishes:** matt and glossy lacquer in the Galimberti Nino colour range / natural walnut / honey walnut / matt and glossy tobacco walnut / moreo walnut

**Legs ferrules:** bronze painted / satin brass

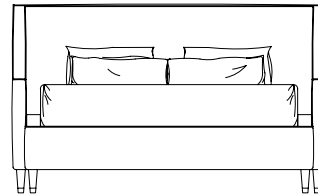

**KEL 16E**  
Bed 160

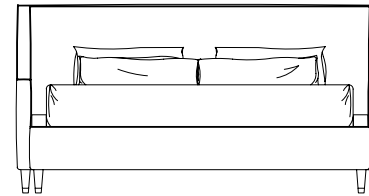

**KEL 03C**  
Bed 180

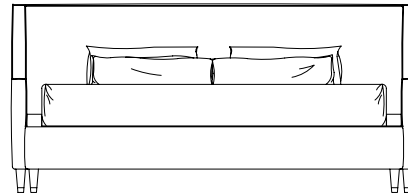



**KEL 04D**  
Bed 200



 | [VIEW ON WEBSITE](#) >

 | [GALLERY](#) >

 | [BEDS](#) >

 | [FINISHES](#) >

 | [UPHOLSTERY](#) >

## Bed 160

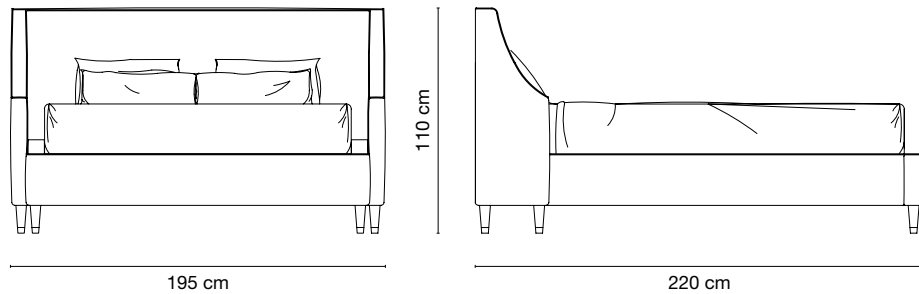
**TECHNICAL FEATURES**

**Structure:** solid wood and plywood panels

**Legs:** solid toulipier wood / solid walnut wood

**Headboard, footboard and sides:** padding in variable density high-resistance foam polyurethane / non-removable cover

**Legs ferrules:** brass

**Piping:** gros grain

**Mattress' support:** metal bed frame with wooden slats

**Protective glides:** felt

**Mattress (not included):** size 160 x 200 x h.22 cm

Cushions and bed set not included

Packaging	not assembled	cbm.	kg.
Standard	●	1,46	122
Wooden crate**	●	2,30	*

\* weight to be confirmed \*\* slatted base not included

KEL 16E	Matt lacquered				Glossy lacquered				Matt walnut				Glossy walnut
	M001 M002 M003 M004 M005 M014	M006 M007 M011 M012 M013 M015 M018 M019	G001 G002 G003 G004 G005 G014	G006 G007 G011 G012 G013 G015 G018 G019	Natural Walnut NO.020.NA	Honey Walnut NO.020.MI	Tobacco Walnut NO.020.TA	Moro Walnut NO.020.MO	Tobacco Walnut NO.100.TA				
Customer's fabric mtl. 8,00	●	●	●	●	●	●	●	●	●				
Fabric cat. A	●	●	●	●	●	●	●	●	●				
Fabric cat. B	●	●	●	●	●	●	●	●	●				
Fabric cat. C	●	●	●	●	●	●	●	●	●				
Fabric cat. D	●	●	●	●	●	●	●	●	●				

| GALLERY >

| BEDS >

| FINISHES >

| UPHOLSTERY >

## Bed 180

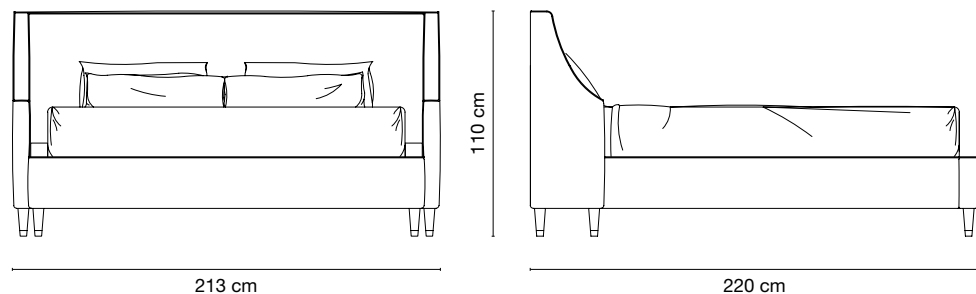

## TECHNICAL FEATURES

**Structure:** solid wood and plywood panels

**Legs:** solid toulipier wood / solid walnut wood

**Headboard, footboard and sides:** padding in variable density high-resistance foam polyurethane / non-removable cover

**Legs ferrules:** brass

**Piping:** gros grain

**Mattress' support:** metal bed frame with wooden slats

**Protective glides:** felt

**Mattress (not included):** size 180 x 200 x h.22 cm

Cushions and bed set not included

Packaging	not assembled	cbm.	kg.
Standard	●	1,58	133
Wooden crate**	●	2,46	*

\* weight to be confirmed \*\* slatted base not included

KEL 03C	Matt lacquered				Glossy lacquered				Matt walnut				Glossy walnut
	M001 M002 M003 M004 M005 M014	M006 M007 M011 M012 M013 M015 M018 M019	G001 G002 G003 G004 G005 G014	G006 G007 G011 G012 G013 G015 G018 G019	Natural Walnut NO.020.NA	Honey Walnut NO.020.MI	Tobacco Walnut NO.020.TA	Moro Walnut NO.020.MO	Tobacco Walnut NO.100.TA				
Customer's fabric mtl. 8,00	●	●	●	●	●	●	●	●	●				
Fabric cat. A	●	●	●	●	●	●	●	●	●				
Fabric cat. B	●	●	●	●	●	●	●	●	●				
Fabric cat. C	●	●	●	●	●	●	●	●	●				
Fabric cat. D	●	●	●	●	●	●	●	●	●				

| GALLERY >

| BEDS >

| FINISHES >

| UPHOLSTERY >

## Bed 200

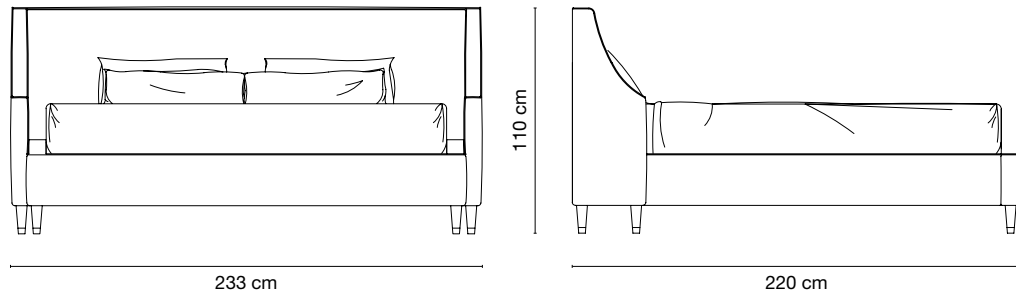
**TECHNICAL FEATURES****Structure:** solid wood and plywood panels**Legs:** solid toulipier wood / solid walnut wood**Headboard, footboard and sides:** padding in variable density high-resistance foam polyurethane / non-removable cover**Legs ferrules:** brass**Piping:** gros grain**Mattress' support:** metal bed frame with wooden slats**Protective glides:** felt**Mattress (not included):** size 200 x 200 x h.22 cm

Cushions and bed set not included

Packaging	not assembled	cbm.	kg.
Standard	●	1,68	150
Wooden crate**	●	2,62	*

\* weight to be confirmed \*\* slatted base not included

KEL 04D	Matt lacquered				Glossy lacquered				Matt walnut				Glossy walnut
	M001 M002 M003 M004 M005 M014	M006 M007 M011 M012 M013 M015 M018 M019	G001 G002 G003 G004 G005 G014	G006 G007 G011 G012 G013 G015 G018 G019	Natural Walnut NO.020.NA	Honey Walnut NO.020.MI	Tobacco Walnut NO.020.TA	Moro Walnut NO.020.MO	Tobacco Walnut NO.100.TA				
Customer's fabric mtl. 8,80	●	●	●	●	●	●	●	●	●				
Fabric cat. A	●	●	●	●	●	●	●	●	●				
Fabric cat. B	●	●	●	●	●	●	●	●	●				
Fabric cat. C	●	●	●	●	●	●	●	●	●				
Fabric cat. D	●	●	●	●	●	●	●	●	●				

| GALLERY &gt;

| BEDS &gt;

| FINISHES &gt;

| UPHOLSTERY &gt;



Strict by symmetrical and regular lines Kobe desk represents order and rationality. The metal inserts create the frame for the wooden elements that compose the item. It generates essential shapes that are capable to host decorative details, such as handles and leather pocket with embossed stitching, which make it charming and unique.

**Top and structure finishes:** natural walnut / honey walnut / matt and glossy tobacco walnut / moro walnut

**Metal insets finishes:** matt black

**Cintura handles finishes:** leather in the Galimberti Nino colour range

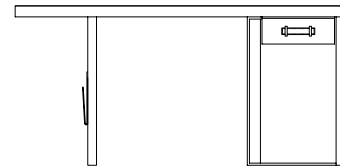

**KOB 02B**  
Desk DX

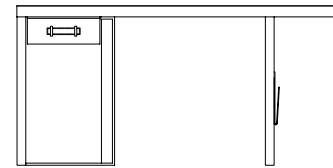

**KOB 03C**  
Desk SX

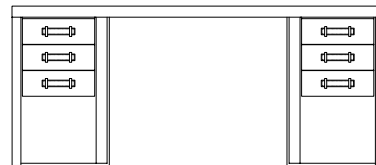



**KOB 04D**  
Desk



 | [VIEW ON WEBSITE](#) >

 | [GALLERY](#) >

 | [DESKS](#) >

 | [FINISHES](#) >

 | [UPHOLSTERY](#) >

Desk DX

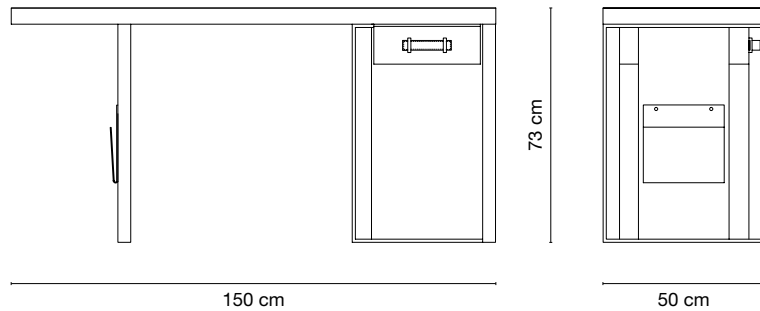
**TECHNICAL FEATURES**

**Top, structure and drawer's frontal:** chipboard panels covered with walnut wood veneer

**Drawer's structure:** birch plywood / drawer runners with Blumotion technology

**Sides frame:** painted metal

**Cintura handle and magazine pocket:** painted metal and leather

**Protective glides:** soft non-scratch rubber

Packaging	assembled	cbm.	kg.
Standard	●	0,70	45
Pallet	●	0,82	*
Wooden crate	●	1,08	*

\* weight to be confirmed

KOB 02B	Matt walnut				Glossy walnut
	Natural Walnut NO.020.NA	Honey Walnut NO.020.MI	Tobacco Walnut NO.020.TA	Moro Walnut NO.020.MO	Tobacco Walnut NO.100.TA
Leather	●	●	●	●	●
Leather Lux	●	●	●	●	●

| GALLERY &gt;

| DESKS &gt;

| FINISHES &gt;

| UPHOLSTERY &gt;

## Desk SX

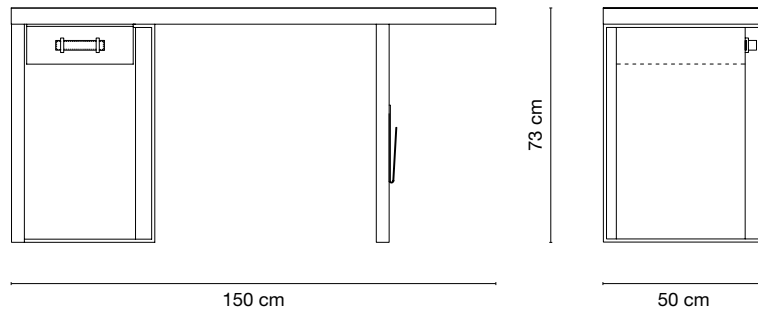
**TECHNICAL FEATURES**

**Top, structure and drawer's frontal:** chipboard panels covered with walnut wood veneer

**Drawer's structure:** birch plywood / drawer runners with Blumotion technology

**Sides frame:** painted metal

**Cintura handle and magazine pocket:** painted metal and leather

**Protective glides:** soft non-scratch rubber

Packaging	assembled	cbm.	kg.
Standard	●	0,70	45
Pallet	●	0,82	*
Wooden crate	●	1,08	*

\* weight to be confirmed

KOB 03C	Matt walnut				Glossy walnut
	Natural Walnut NO.020.NA	Honey Walnut NO.020.MI	Tobacco Walnut NO.020.TA	Moro Walnut NO.020.MO	Tobacco Walnut NO.100.TA
Leather	●	●	●	●	●
Leather Lux	●	●	●	●	●

| GALLERY >

| DESKS >

| FINISHES >

| UPHOLSTERY >

## Desk

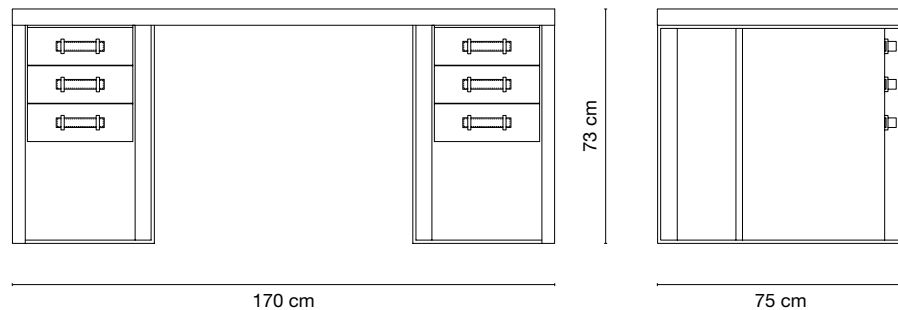
**TECHNICAL FEATURES**

**Top, structure and drawer's frontal:** plywood, MDF and chipboard panels covered with walnut wood veneer

**Drawer's structure:** birch plywood / drawer runners with Blumotion technology

**Sides frame:** painted metal

**Cintura handles:** painted metal and leather

**Protective glides:** soft non-scratch rubber

Packaging	assembled	cbm.	kg.
Standard	●	1,12	116
Pallet	●	1,34	*
Wooden crate	●	1,68	*

\* weight to be confirmed

KOB 04D	Matt walnut				Glossy walnut
	Natural Walnut NO.020.NA	Honey Walnut NO.020.MI	Tobacco Walnut NO.020.TA	Moro Walnut NO.020.MO	Tobacco Walnut NO.100.TA
Leather	●	●	●	●	●
Leather Lux	●	●	●	●	●

 | GALLERY >

 | DESKS >

 | FINISHES >

 | UPHOLSTERY >





The minimalist design and comfortable shape of this stunning piece make it a precious addition to both a modern and a contemporary home, where it will provide extra seating in a living room or can be used as a footrest next to an armchair in a study, in a bedroom or in an entrance hall.

**Covers:** fabric / leather

**Base finishes:** matt and glossy lacquer in the Galimberti Nino colour range

 | [VIEW ON WEBSITE](#) >



**KUB 01A**  
Ottoman >

 | [GALLERY](#) >

 | [ARMCHAIRS AND OTTOMANS](#) >

 | [FINISHES](#) >

 | [UPHOLSTERY](#) >

## Ottoman

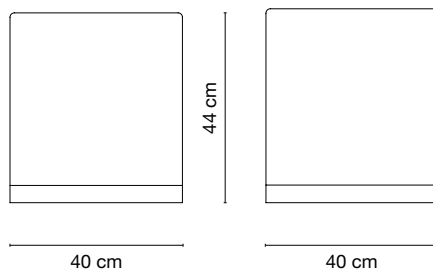
**TECHNICAL FEATURES****Structure:** plywood panels**Seat:** padding in variable density high-resistance foam polyurethane / non-removable cover**Base:** solid beech wood**Protective glides:** felt

Packaging	assembled	cbm.	kg.
Standard	●	0,14	11
Wooden crate	●	0,26	*

\* weight to be confirmed

KUB 01A	Matt lacquered				Glossy lacquered			
	M001 M002 M003 M004 M005 M014	M006 M007 M011 M012 M013 M015 M018 M019	G001 G002 G003 G004 G005 G014	G006 G007 G011 G012 G013 G015 G018 G019				
Customer's fabric mtl. 1,00	●	●	●	●				
Fabric cat. A	●	●	●	●				
Fabric cat. B	●	●	●	●				
Fabric cat. C	●	●	●	●				
Fabric cat. D	●	●	●	●				
Leather	●	●	●	●				
Leather Lux	●	●	●	●				



| GALLERY &gt;

| ARMCHAIRS AND OTTOMANS &gt;

| FINISHES &gt;

| UPHOLSTERY &gt;



The Ladone bed is timeless and sophisticated, boasting a classic silhouette and a modern chromatic combination to highlight the multiple shades of colour. The unique design integrates a comfortable curved headboard and a shaped footboard, intriguingly upholstered.

**Covers:** fabric

**Structure finishes:** natural walnut / honey walnut / matt and glossy tobacco walnut / moro walnut

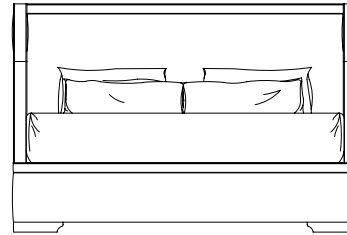

LAD 16C  
Bed 160 >

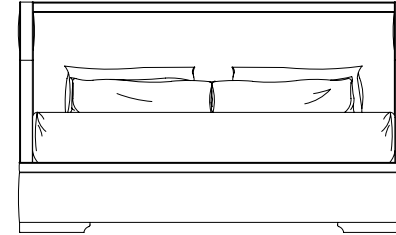

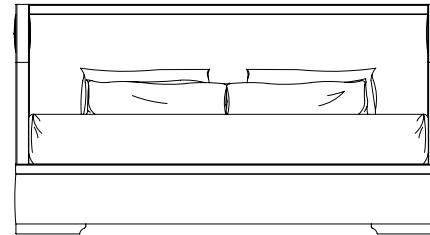

LAD 21P  
Bed 180 >





LAD 22S  
Bed 200 >

 | [VIEW ON WEBSITE](#) >

 | [GALLERY](#) >

 | [BEDS](#) >

 | [FINISHES](#) >

 | [UPHOLSTERY](#) >

# LADONE | Studio Galimberti - 2019

## Bed 160

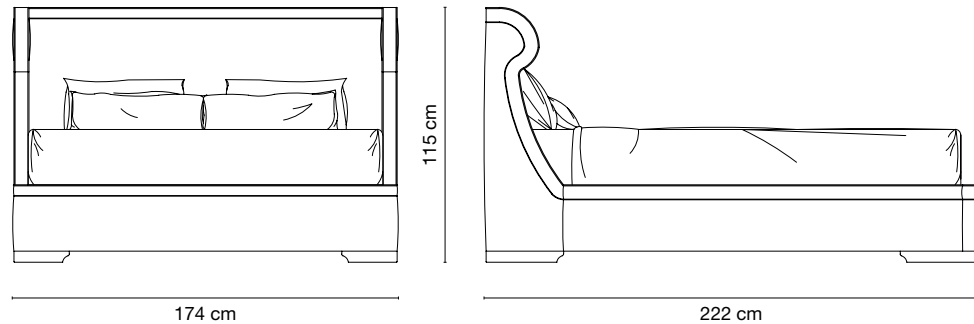

### TECHNICAL FEATURES

**Structure:** solid wood and plywood panels

**Legs:** solid walnut wood

**Headboard, footboard and sides:** padding in variable density high-resistance foam polyurethane / non-removable cover

**Piping:** gros grain

**Mattress' support:** metal bed frame with wooden slats

**Protective glides:** felt

**Mattress (not included):** size 160 x 200 x h.22 cm

Cushions and bed set not included

Packaging	not assembled	cbm.	kg.
Standard	●	1,46	125
Wooden crate**	●	2,28	*

\* weight to be confirmed \*\* slatted base not included

LAD 16C	Matt walnut				Glossy walnut
	Natural Walnut NO.020.NA	Honey Walnut NO.020.MI	Tobacco Walnut NO.020.TA	Moro Walnut NO.020.MO	Tobacco Walnut NO.100.TA
Customer's fabric mtl. 10,00	●	●	●	●	●
Fabric cat. A	●	●	●	●	●
Fabric cat. B	●	●	●	●	●
Fabric cat. C	●	●	●	●	●
Fabric cat. D	●	●	●	●	●

 | GALLERY >

 | BEDS >

 | FINISHES >

 | UPHOLSTERY >

# LADONE | Studio Galimberti - 2019

Bed 180

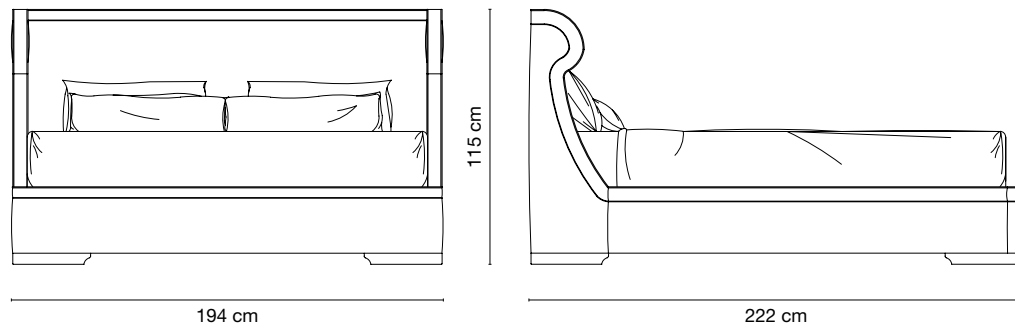

## TECHNICAL FEATURES

**Structure:** solid wood and plywood panels

**Legs:** solid walnut wood

**Headboard, footboard and sides:** padding in variable density high-resistance foam polyurethane / non-removable cover

**Piping:** gros grain

**Mattress' support:** metal bed frame with wooden slats

**Protective glides:** felt

**Mattress (not included):** size 180 x 200 x h.22 cm

Cushions and bed set not included

Packaging	not assembled	cbm.	kg.
Standard	●	1,58	136
Wooden crate**	●	2,46	*

\* weight to be confirmed \*\* slatted base not included

LAD 21P	Matt walnut				Glossy walnut
	Natural Walnut NO.020.NA	Honey Walnut NO.020.MI	Tobacco Walnut NO.020.TA	Moro Walnut NO.020.MO	Tobacco Walnut NO.100.TA
Customer's fabric mtl. 10,00	●	●	●	●	●
Fabric cat. A	●	●	●	●	●
Fabric cat. B	●	●	●	●	●
Fabric cat. C	●	●	●	●	●
Fabric cat. D	●	●	●	●	●

 | GALLERY >

 | BEDS >

 | FINISHES >

 | UPHOLSTERY >

# LADONE | Studio Galimberti - 2019

Bed 200

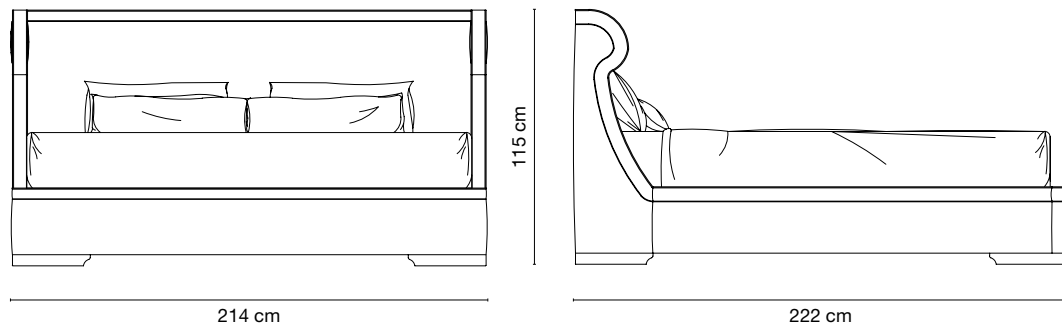

## TECHNICAL FEATURES

**Structure:** solid wood and plywood panels

**Legs:** solid walnut wood

**Headboard, footboard and sides:** padding in variable density high-resistance foam polyurethane / non-removable cover

**Piping:** gros grain

**Mattress' support:** metal bed frame with wooden slats

**Protective glides:** felt

**Mattress (not included):** size 200 x 200 x h.22 cm

Cushions and bed set not included

Packaging	not assembled	cbm.	kg.
Standard	●	1,74	153
Wooden crate**	●	2,68	*

\* weight to be confirmed \*\* slatted base not included

LAD 22S	Matt walnut				Glossy walnut
	Natural Walnut NO.020.NA	Honey Walnut NO.020.MI	Tobacco Walnut NO.020.TA	Moro Walnut NO.020.MO	Tobacco Walnut NO.100.TA
Customer's fabric mtl. 11,00	●	●	●	●	●
Fabric cat. A	●	●	●	●	●
Fabric cat. B	●	●	●	●	●
Fabric cat. C	●	●	●	●	●
Fabric cat. D	●	●	●	●	●

 | GALLERY >

 | BEDS >

 | FINISHES >

 | UPHOLSTERY >



Sophisticated shapes of the Lirica console evoke the style of the 1950s revisited in the contemporary key. Its soft but elegant lines reflect the perfect harmony between style and functionality allowing this piece to express a strong decorative impact in any environment.

**Top and structure finishes:** matt and glossy lacquer in the Galimberti Nino colour range  
**Decò handles finishes:** satin brass

 | [VIEW ON WEBSITE](#) >

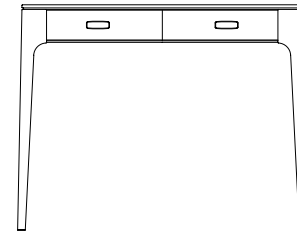



**LIR 63B**  
Console >



 | [GALLERY](#) >

 | [CONSOLES](#) >

 | [FINISHES](#) >

 | [UPHOLSTERY](#) >

Console

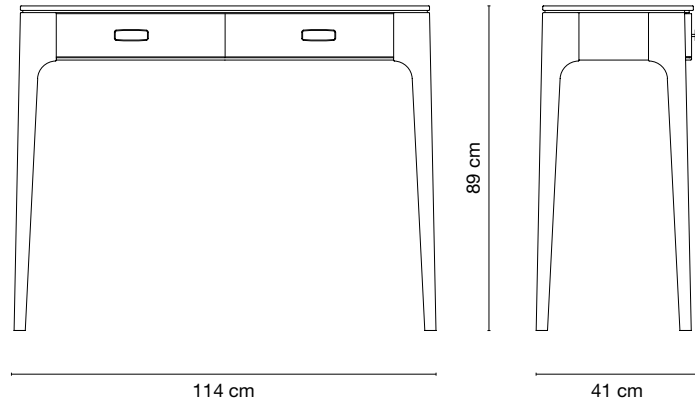

### TECHNICAL FEATURES

**Top, structure and drawers' frontal:** MDF panels and toulipier solid wood  
**Drawers' structure:** plywood and MDF panels / drawers runners with Blumotion technology  
**Legs:** toulipier solid wood  
**Decò handles:** brass with buffalo's horn inset  
**Protective glides:** felt

Packaging	assembled	cbm.	kg.
Standard	●	0,56	37
Pallet	●	0,64	*
Wooden crate	●	0,88	*

\* weight to be confirmed

LIR 63B	Matt lacquered				Glossy lacquered			
	M001 M002 M003 M004 M005 M014	M006 M007 M011 M012 M013 M015 M018 M019	G001 G002 G003 G004 G005 G014	G006 G007 G011 G012 G013 G015 G018 G019				
	●	●	●	●				

- | GALLERY >
- | CONSOLES >
- | FINISHES >
- | UPHOLSTERY >



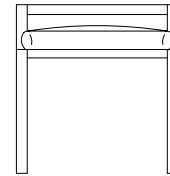

**LCY 22E**  
Chair >

This stunning chair will be a precious seating option around a dining table, in an entryway or behind a desk, and it will add a sculptural decoration that will not pass unnoticed. Its soft pluffy seat contrasts with the rigorous geometry of the unique silhouette with its minimal lines.

**Covers:** fabric / leather

**Base finishes:** natural walnut / honey walnut / matt and glossy tobacco walnut / moro walnut

 | [VIEW ON WEBSITE](#) >

 | [GALLERY](#) >

 | [CHAIRS](#) >

 | [FINISHES](#) >

 | [UPHOLSTERY](#) >

Chair

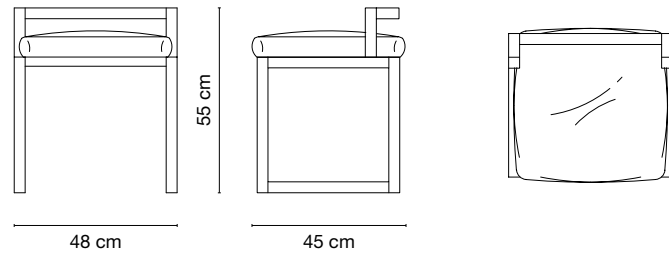
**TECHNICAL FEATURES****Structure:** solid walnut**Seat:** plywood panel / padding in variable density high-resistance foam polyurethane / non-removable cover**Protective glides:** felt

Packaging	assembled	cbm.	kg.
Standard	●	0,18	8
Wooden crate	●	0,32	*

\* weight to be confirmed

LCY 22E	Matt walnut				Glossy walnut
	Natural Walnut NO.020.NA	Honey Walnut NO.020.MI	Tobacco Walnut NO.020.TA	Moro Walnut NO.020.MO	Tobacco Walnut NO.100.TA
Customer's fabric mtl. 0,50	●	●	●	●	●
Fabric cat. A	●	●	●	●	●
Fabric cat. B	●	●	●	●	●
Fabric cat. C	●	●	●	●	●
Fabric cat. D	●	●	●	●	●
Leather	●	●	●	●	●
Leather Lux	●	●	●	●	●

 | GALLERY >

 | CHAIRS >

 | FINISHES >

 | UPHOLSTERY >



With the strong personality and timeless, this is a stunning piece for a modern or classic private studio or bedroom, where it will create a sophisticated atmosphere, thanks to its elegant materials and linear silhouette. The lacquered structure, the drawers, enriched with buffalo horn handles, and sculptural legs, underlined with brass ferrules, represent the unique and incomparable style.

**Tops and structure finishes:** matt and glossy lacquer in the Galimberti Nino colour range  
**Metal finishes:** bronze painted / satin brass  
**Dodo handles finishes:** buffalo's blond veined horn

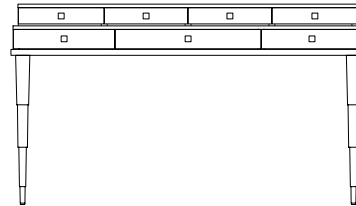

**LUM 11A**  
High desk >

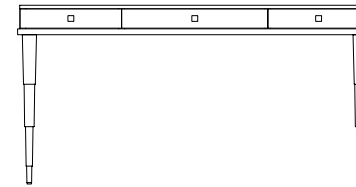



**LUM 12B**  
Desk >

 | [VIEW ON WEBSITE](#) >



 | [GALLERY](#) >

 | [DESKS](#) >

 | [FINISHES](#) >

 | [UPHOLSTERY](#) >

High desk

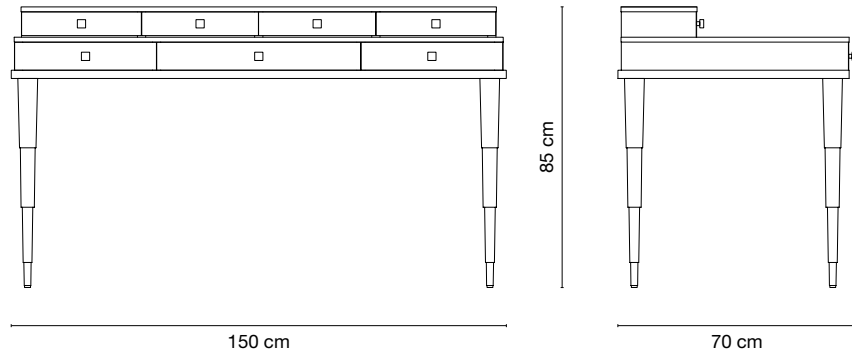

**TECHNICAL FEATURES**

**Tops, structure and drawers:** plywood, MDF and chipboard panels / drawer runners with Blumotion technology (except upper small drawers)

**Legs:** toulipier massive wood

**Legs ferrules:** brass





**Protective glides:** felt

Packaging	not assembled	cbm.	kg.
Standard	•	0,36	64
Wooden crate	•	0,66	*

\* weight to be confirmed

LUM 11A	Matt lacquered				Glossy lacquered			
	M001 M002 M003 M004 M005 M014	M006 M007 M011 M012 M013 M015 M018 M019	G001 G002 G003 G004 G005 G014	G006 G007 G011 G012 G013 G015 G018 G019				
	•	•	•	•				



-  | GALLERY >
-  | DESKS >
-  | FINISHES >
-  | UPHOLSTERY >

Desk

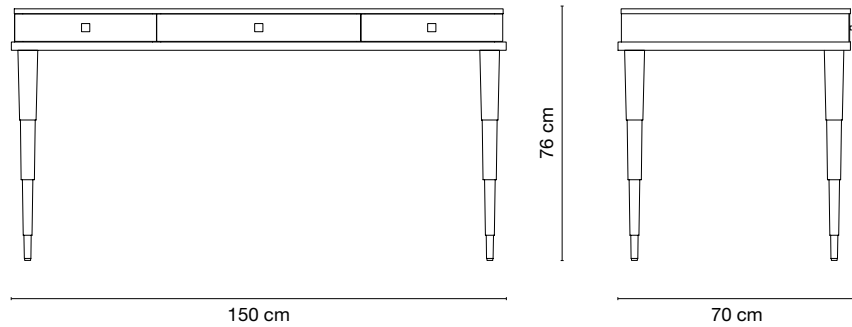

**TECHNICAL FEATURES**

**Tops, structure and drawers:** plywood, MDF and chipboard panels / drawer runners with Blumotion technology

**Legs:** toulipier massive wood





**Legs ferrules:** brass

**Protective glides:** felt

Packaging	not assembled	cbm.	kg.
Standard	•	0,28	48
Wooden crate	•	0,54	*

\* weight to be confirmed

LUM 12B	Matt lacquered				Glossy lacquered			
	M001 M002 M003 M004 M005 M014	M006 M007 M011 M012 M013 M015 M018 M019	G001 G002 G003 G004 G005 G014	G006 G007 G011 G012 G013 G015 G018 G019				
	•	•	•	•				

-  | GALLERY >
-  | DESKS >
-  | FINISHES >
-  | UPHOLSTERY >



With the strong personality and timeless, this is a stunning piece for a modern or classic bedroom, where it will create a sophisticated atmosphere, thanks to its elegant materials and linear silhouette. The lacquered structure, the drawers, enriched with buffalo horn handles, and sculptural legs, underlined with brass ferrules, represent the unique and incomparable style.

**Tops and structure finishes:** matt and glossy lacquer in the Galimberti Nino colour range  
**Metal finishes:** bronze painted / satin brass  
**Dodo handles finishes:** buffalo's blond veined horn

 | [VIEW ON WEBSITE](#) >

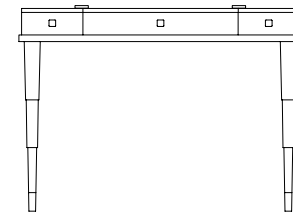



**LUM 13C**  
Vanity table >



 | [GALLERY](#) >

 | [VANITY TABLES](#) >

 | [FINISHES](#) >

 | [UPHOLSTERY](#) >

Vanity table

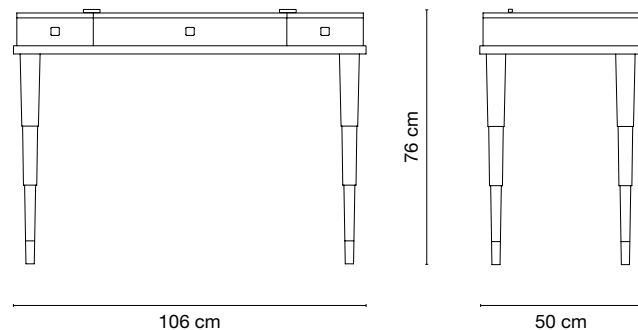

**TECHNICAL FEATURES**

**Tops, structure and drawers:** plywood, MDF and chipboard panels / drawer runners with Blumotion technology

**Legs:** toulipier massive wood

**Legs ferrules:** brass

**Protective glides:** felt

Packaging	not assembled	cbm.	kg.
Standard	•	0,22	29
Wooden crate	•	0,42	*

\* weight to be confirmed

LUM 13C	Matt lacquered				Glossy lacquered			
	M001 M002 M003 M004 M005 M014	M006 M007 M011 M012 M013 M015 M018 M019	G001 G002 G003 G004 G005 G014	G006 G007 G011 G012 G013 G015 G018 G019				
	•	•	•	•				

-  | GALLERY >
-  | VANITY TABLES >
-  | FINISHES >
-  | UPHOLSTERY >



With the strong personality and timeless, this is a stunning piece for a modern or classic room, where it will create a sophisticated atmosphere, thanks to its elegant materials and linear silhouette. The lacquered structure and the sculptural legs, underlined with brass ferrules, represent the unique and incomparable style.

**Tops and structure finishes:** matt and glossy lacquer in the Galimberti Nino colour range  
**Metal finishes:** bronze painted / satin brass

 | [VIEW ON WEBSITE](#) >





**LUM 14D**  
Console >



 | [GALLERY](#) >

 | [CONSOLES](#) >

 | [FINISHES](#) >

 | [UPHOLSTERY](#) >



Console

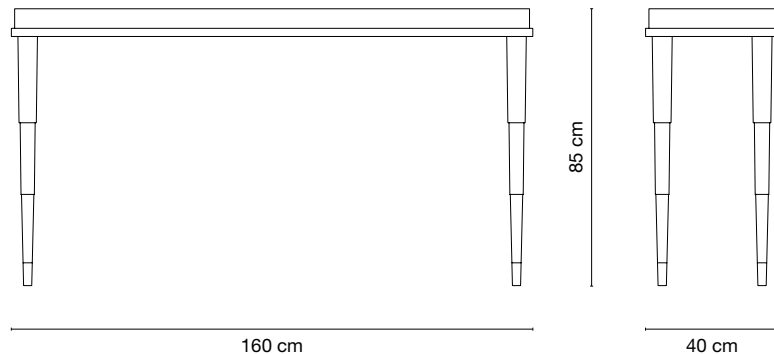

**TECHNICAL FEATURES**

**Tops:** honeycomb MDF panels

**Legs:** toulipier massive wood

**Legs ferrules:** brass

**Protective glides:** felt

Packaging	not assembled	cbm.	kg.
Standard	•	0,16	26
Wooden crate	•	0,36	*

\* weight to be confirmed

LUM 14D	Matt lacquered				Glossy lacquered			
	M001 M002 M003 M004 M005 M014	M006 M007 M011 M012 M013 M015 M018 M019	G001 G002 G003 G004 G005 G014	G006 G007 G011 G012 G013 G015 G018 G019				
	•	•	•	•				

-  | GALLERY >
-  | CONSOLES >
-  | FINISHES >
-  | UPHOLSTERY >



**MAR 28N**  
Dining table

The architectural shape, massive and functional but at the same time refined and sophisticated, the elegant combination of materials and finishes and the fine craftsmanship of the Marton table will put it at the center of attention in any environment. Marton will be able to express the prevalence of pure form over decoration with its harmonious and natural presence.

**Top and structure finishes:** natural walnut / honey walnut / matt and glossy tobacco walnut / moro walnut

**Metal insets finishes:** matt black

 | GALLERY >

 | DINING TABLES >

 | FINISHES >

 | UPHOLSTERY >

## Dining table

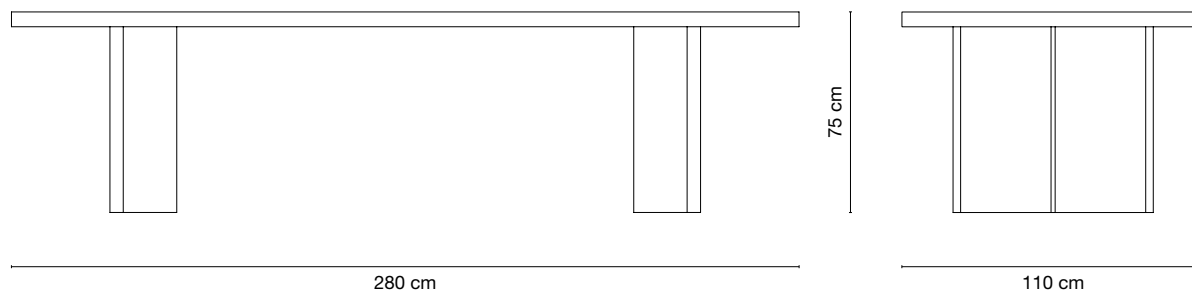

## TECHNICAL FEATURES

**Top:** honeycomb MDF panel covered with walnut wood veneer

**Bases:** chipboard panels covered with walnut wood veneer and solid walnut insets

**Metal insets:** painted metal

**Protective glides:** felt

Packaging	not assembled	cbm.	kg.
Standard	●	0,90	136
Wooden crate	●	1,80	*

\* weight to be confirmed

MAR 28N	Matt walnut				Glossy walnut	
	Natural Walnut NO.020.NA	Honey Walnut NO.020.MI	Tobacco Walnut NO.020.TA	Moro Walnut NO.020.MO	Tobacco Walnut NO.100.TA	
	●	●	●	●	●	

 | GALLERY >

 | DINING TABLES >

 | FINISHES >

 | UPHOLSTERY >

# MODULO | Studio Galimberti - 2007



A library with a rigorous and light character, which allows it to fit harmoniously into any environment, Modulo is simply "The Library". A wonderful piece of decoration characterized by a pure and essential line, by a studied simplicity of the design and a choice of sophisticated materials and refined details that allow it to play a leading role within the living space, thanks to the variety of proposed finishes, which give it a strong decorative charm of contemporary taste.

**Tops and sides finishes:** natural walnut / honey walnut / matt and glossy tobacco walnut / moro walnut

**Inner sides and back panels finishes:** matt and glossy lacquer in the Galimberti Nino colour range

**Glass finishes:** bronze

**Metal insets and Accento handles finishes:** bronze painted / satin brass

 | [VIEW ON WEBSITE](#) >

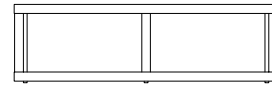

**MOD 201**  
1 shelf bookcase >

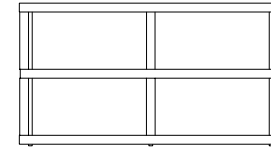

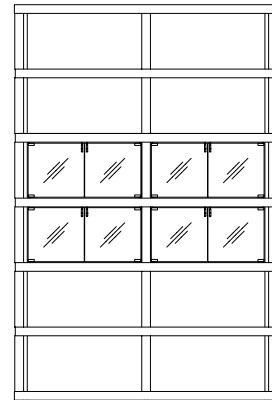

**MOD 202**  
2 shelves bookcase >





**MOD 206**  
6 shelves bookcase >



 | [GALLERY](#) >

 | [BOOKCASES](#) >

 | [FINISHES](#) >

 | [UPHOLSTERY](#) >

# MODULO

 | Studio Galimberti - 2007

1 shelf bookcase

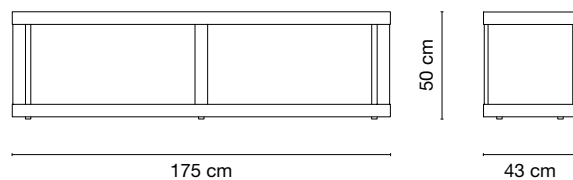
**TECHNICAL FEATURES**

**Tops and sides:** honeycomb MDF, MDF and chipboard panels covered with walnut wood veneer

**Inner sides and back panels:** MDF and chipboard panels

**Protective glides:** adjustable leveller with ABS base

Packaging	not assembled	cbm.	kg.
Standard	●	0,28	50
Pallet	●	0,42	*
Wooden crate	●	0,58	*

\* weight to be confirmed

MOD 201		Matt walnut				Glossy walnut
		Natural Walnut NO.020.NA	Honey Walnut NO.020.MI	Tobacco Walnut NO.020.TA	Moro Walnut NO.020.MO	Tobacco Walnut NO.100.TA
Matt lacquered	M001 M002 M003 M004 M005 M014	●	●	●	●	●
	M006 M007 M011 M012 M013 M015	●	●	●	●	●
Glossy lacquered	G001 G002 G003 G004 G005 G014	●	●	●	●	●
	G006 G007 G011 G012 G013 G015	●	●	●	●	●

| GALLERY &gt;

| BOOKCASES &gt;

| FINISHES &gt;

| UPHOLSTERY &gt;

# MODULO | Studio Galimberti - 2007

2 shelves bookcase

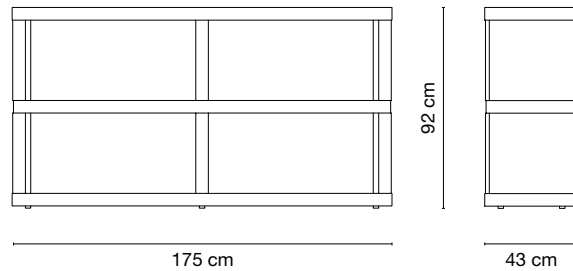

## TECHNICAL FEATURES

**Tops and sides:** honeycomb MDF, MDF and chipboard panels covered with walnut wood veneer

**Inner sides and back panels:** MDF and chipboard panels

**Protective glides:** adjustable leveller with ABS base

Packaging	not assembled	cbm.	kg.
Standard	●	0,46	85
Pallet	●	0,60	*
Wooden crate	●	0,80	*

\* weight to be confirmed

MOD 202		Matt walnut				Glossy walnut
		Natural Walnut NO.020.NA	Honey Walnut NO.020.MI	Tobacco Walnut NO.020.TA	Moro Walnut NO.020.MO	Tobacco Walnut NO.100.TA
Matt lacquered	M001 M002 M003 M004 M005 M014	●	●	●	●	●
	M006 M007 M011 M012 M013 M015	●	●	●	●	●
Glossy lacquered	G001 G002 G003 G004 G005 G014	●	●	●	●	●
	G006 G007 G011 G012 G013 G015	●	●	●	●	●

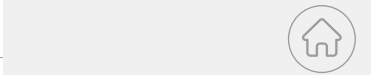

| GALLERY >

| BOOKCASES >

| FINISHES >

| UPHOLSTERY >

# MODULO

 | Studio Galimberti - 2007

6 shelves bookcase

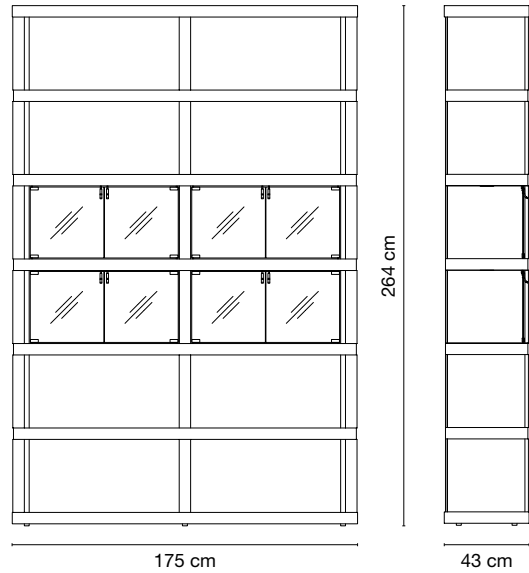
**TECHNICAL FEATURES**

**Tops and sides:** honeycomb MDF, MDF and chipboard panels covered with walnut wood veneer

**Inner sides and back panels:** MDF and chipboard panels

**Glass doors:** 5 mm thick tempered glass

**Metal insets and Accento handles:** brass

**Protective glides:** adjustable leveller with ABS base

Packaging	not assembled	cbm.	kg.
Standard	●	1,34	243
Pallet	●	1,48	*
Wooden crate	●	2,04	*

\* weight to be confirmed

MOD 206		Matt walnut				Glossy walnut
		Natural Walnut NO.020.NA	Honey Walnut NO.020.MI	Tobacco Walnut NO.020.TA	Moro Walnut NO.020.MO	Tobacco Walnut NO.100.TA
Matt lacquered	M001 M002 M003 M004 M005 M014	●	●	●	●	●
	M006 M007 M011 M012 M013 M015	●	●	●	●	●
Glossy lacquered	G001 G002 G003 G004 G005 G014	●	●	●	●	●
	G006 G007 G011 G012 G013 G015	●	●	●	●	●

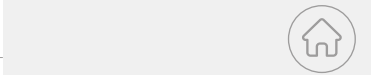

| GALLERY &gt;

| BOOKCASES &gt;

| FINISHES &gt;

| UPHOLSTERY &gt;

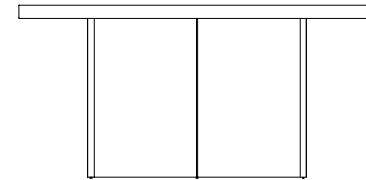

**MOR 23C**  
Dining table

The elegance of Morgan dining table will stand out in a modern or contemporary environment, where it will be an important presence thanks to its harmonious combination of geometric and metallic elements. The lacquered base is embellished with light metal inserts that underline its formal linearity.

**Top and structure finishes:** matt and glossy lacquer in the Galimberti Nino colour range

**Metal finishes:** bronze painted / satin brass

 | [VIEW ON WEBSITE](#) >

 | [GALLERY](#) >

 | [DINING TABLES](#) >

 | [FINISHES](#) >

 | [UPHOLSTERY](#) >

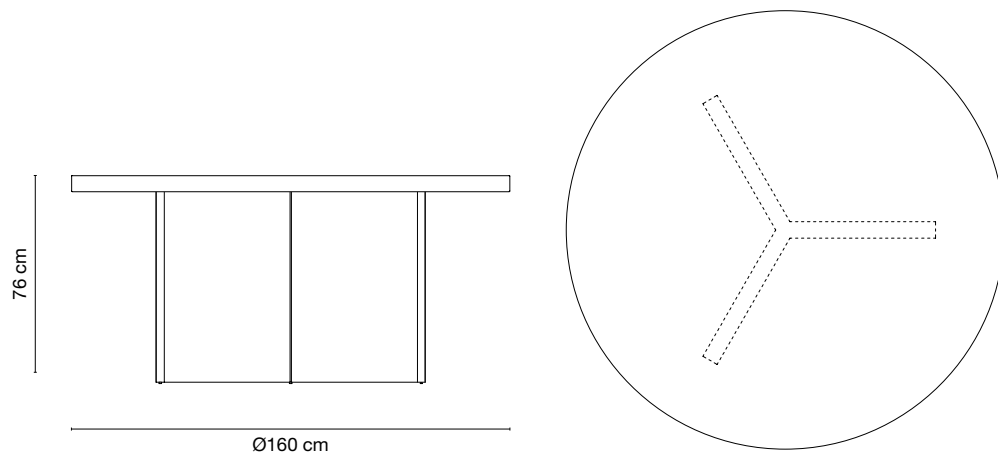

Dining table

**TECHNICAL FEATURES****Top:** honeycomb MDF panel**Structure:** honeycomb MDF panels**Metal insets:** brass**Protective glides:** felt

Packaging	not assembled	cbm.	kg.
Standard	•	1,10	89
Pallet**	•	1,28	*
Wooden crate	•	1,88	*

\* weight to be confirmed \*\* top not included

MOR 23C	Matt lacquered				Glossy lacquered			
	M001 M002 M003 M004 M005 M014	M006 M007 M011 M012 M013 M015 M018 M019	G001 G002 G003 G004 G005 G014	G006 G007 G011 G012 G013 G015 G018 G019				
	•	•	•	•				



| GALLERY &gt;

| DINING TABLES &gt;

| FINISHES &gt;

| UPHOLSTERY &gt;



The elegance of Morgan coffee table will stand out in a modern or contemporary environment, where it will be an important presence thanks to its harmonious combination of geometric and metallic elements. The lacquered base is embellished with light metal inserts that underline its formal linearity.

**Top and structure finishes:** matt and glossy lacquer in the Galimberti Nino colour range  
**Metal finishes:** bronze painted / satin brass

 | [VIEW ON WEBSITE](#) >

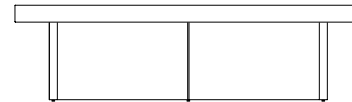

**MOR 25E** >  
Low coffee table

 | [GALLERY](#) >

 | [COFFEE AND SIDE TABLES](#) >

 | [FINISHES](#) >

 | [UPHOLSTERY](#) >

Low coffee table

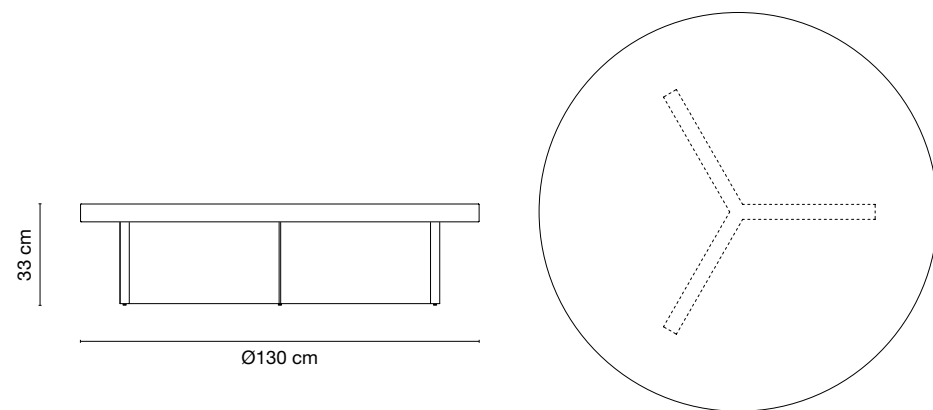
**TECHNICAL FEATURES****Top:** honeycomb MDF panel**Structure:** honeycomb MDF panels**Metal insets:** brass**Protective glides:** felt

Packaging	assembled	cbm.	kg.
Standard	●	0,74	36
Pallet	●	1,02	*
Wooden crate	●	1,28	*

\* weight to be confirmed

MOR 25E	Matt lacquered				Glossy lacquered			
	M001 M002 M003 M004 M005 M014	M006 M007 M011 M012 M013 M015 M018 M019	G001 G002 G003 G004 G005 G014	G006 G007 G011 G012 G013 G015 G018 G019				
	●	●	●	●				

[GALLERY](#) >

[COFFEE AND SIDE TABLES](#) >

[FINISHES](#) >

[UPHOLSTERY](#) >



Art Déco style and oriental scents of the old Japanese city Nara, to which the collection dedicates its name, are naturally fused in the design of these refined night storages. This careful blend of stylistic expressions, so different in the timing line and in the geographical provenience gives birth to a collection with a unique and incomparable style. The design with simple and sophisticated lines at the same time, the use of fine materials, the delicate play of contrast in the handles will give timeless sophistication and elegance to any interior.

**Top finishes:** glossy Bianco Statuario Stoneeco / white glass / black glass

**Structure finishes:** matt and glossy lacquer in the Galimberti Nino colour range / natural walnut / honey walnut / matt and glossy tobacco walnut / moro walnut

**Legs' ferrules and Mira handles finishes:** bronze painted / satin brass with glossy inset

 | [VIEW ON WEBSITE](#) >

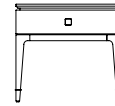

**NAR 21N**  
1 drawer night table >

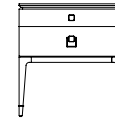

**NAR 10M**  
2 drawers night table >

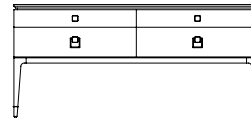

**NAR 08H**  
Chest of 4 drawers >

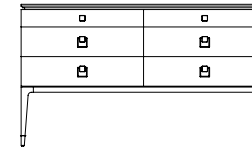

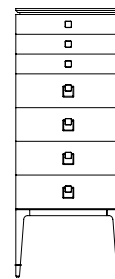

**NAR 07G**  
Chest of 6 drawers >





**NAR 09L**  
Chest of 7 drawers >



 | [GALLERY](#) >

 | [NIGHT STORAGES](#) >

 | [FINISHES](#) >

 | [UPHOLSTERY](#) >

## 1 drawer night table

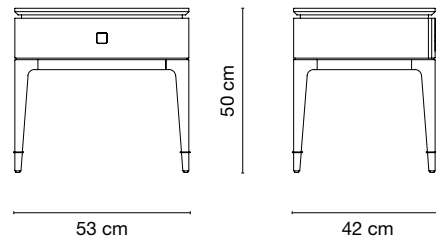
**TECHNICAL FEATURES**

**Top, structure and drawer frontal:** solid toulipier wood frame with Stoneeco or glass 6 mm thick inset, MDF and chipboard panels / solid walnut frame with Stoneeco or glass 6 mm thick inset, MDF and chipboard panels covered with walnut wood veneer  
**Drawer structure:** birch plywood / drawers runners with Blumotion technology  
**Legs:** solid toulipier wood / solid walnut  
**Legs ferrules and Mira handles:** brass  
**Protective glides:** felt

Packaging	assembled	cbm.	kg.	not assembled	cbm.	kg.
Standard	●	0,18	26	●	0,12	26
Pallet	●	0,22	*	●	0,16	*
Wooden crate	●	0,32	*	●	0,24	*

\* weight to be confirmed

NAR 21N	Matt lacquered				Glossy lacquered				Matt walnut				Glossy walnut
	M001 M002 M003 M004 M005 M014	M006 M007 M011 M012 M013 M015 M018 M019	G001 G002 G003 G004 G005 G014	G006 G007 G011 G012 G013 G015 G018 G019	Natural Walnut NO.020.NA	Honey Walnut NO.020.MI	Tobacco Walnut NO.020.TA	Moro Walnut NO.020.MO	Tobacco Walnut NO.100.TA				
White glass	●	●	●	●	●	●	●	●	●				
Black glass	●	●	●	●	●	●	●	●	●				
Stoneeco Bianco Statuario	●	●	●	●	●	●	●	●	●				

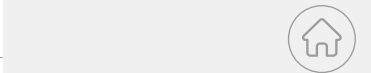

| GALLERY &gt;

| NIGHT STORAGES &gt;

| FINISHES &gt;

| UPHOLSTERY &gt;

## 2 drawers night table

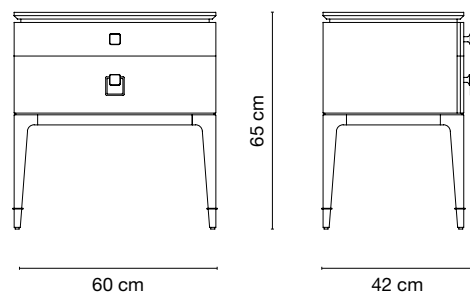
**TECHNICAL FEATURES**

**Top, structure and drawers' frontal:** solid toulipier wood frame with Stoneeco or glass 6 mm thick inset, MDF and chipboard panels / solid walnut frame with Stoneeco or glass 6 mm thick inset, MDF and chipboard panels covered with walnut wood veneer

**Drawers' structure:** birch plywood / drawers runners with Blumotion technology

**Legs:** solid toulipier wood / solid walnut

**Legs ferrules and Mira handles:** brass

**Protective glides:** felt

Packaging	assembled	cbm.	kg.	not assembled	cbm.	kg.
Standard	●	0,24	34	●	0,18	34
Pallet	●	0,28	*	●	0,22	*
Wooden crate	●	0,42	*	●	0,32	*

\* weight to be confirmed

NAR 10M	Matt lacquered				Glossy lacquered				Matt walnut				Glossy walnut
	M001 M002 M003 M004 M005 M014	M006 M007 M011 M012 M013 M015 M018 M019	G001 G002 G003 G004 G005 G014	G006 G007 G011 G012 G013 G015 G018 G019	Natural Walnut NO.020.NA	Honey Walnut NO.020.MI	Tobacco Walnut NO.020.TA	Moro Walnut NO.020.MO	Tobacco Walnut NO.100.TA				
White glass	●	●	●	●	●	●	●	●	●				
Black glass	●	●	●	●	●	●	●	●	●				
Stoneeco Bianco Statuario	●	●	●	●	●	●	●	●	●				

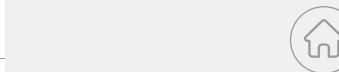

| GALLERY >

| NIGHT STORAGES >

| FINISHES >

| UPHOLSTERY >

Chest of 4 drawers

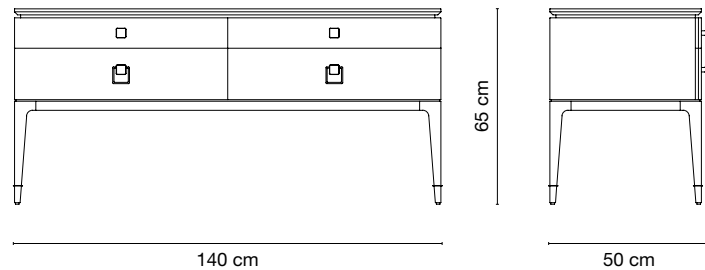
**TECHNICAL FEATURES**

**Top, structure and drawers' frontal:** solid toulipier wood frame with Stoneeco or glass 6 mm thick inset, MDF and chipboard panels / solid walnut frame with Stoneeco or glass 6 mm thick inset, MDF and chipboard panels covered with walnut wood veneer

**Drawers' structure:** birch plywood / drawers runners with Blumotion technology

**Legs:** solid toulipier wood / solid walnut

**Legs ferrules and Mira handles:** brass

**Protective glides:** felt

Packaging	assembled	cbm.	kg.	not assembled	cbm.	kg.
Standard	●	0,56	79	●	0,40	79
Pallet	●	0,68	*	●	0,52	*
Wooden crate	●	0,92	*	●	0,72	*

\* weight to be confirmed

NAR 08H	Matt lacquered				Glossy lacquered				Matt walnut				Glossy walnut
	M001 M002 M003 M004 M005 M014	M006 M007 M011 M012 M013 M015 M018 M019	G001 G002 G003 G004 G005 G014	G006 G007 G011 G012 G013 G015 G018 G019	Natural Walnut NO.020.NA	Honey Walnut NO.020.MI	Tobacco Walnut NO.020.TA	Moro Walnut NO.020.MO	Tobacco Walnut NO.100.TA				
White glass	●	●	●	●	●	●	●	●	●				
Black glass	●	●	●	●	●	●	●	●	●				
Stoneeco Bianco Statuario	●	●	●	●	●	●	●	●	●				

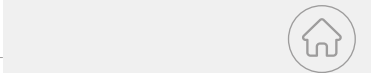

| GALLERY >

| NIGHT STORAGES >

| FINISHES >

| UPHOLSTERY >

Chest of 6 drawers

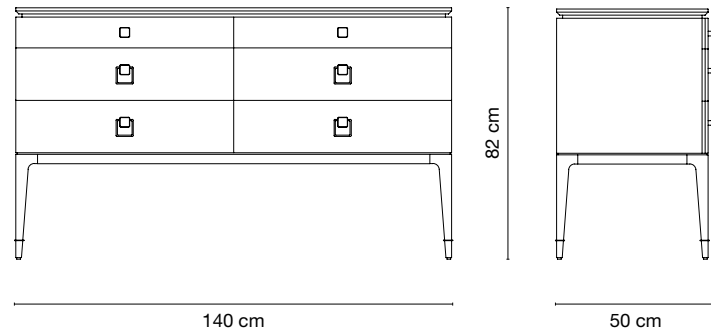
**TECHNICAL FEATURES**

**Top, structure and drawers' frontal:** solid toulipier wood frame with Stoneeco or glass 6 mm thick inset, MDF and chipboard panels / solid walnut frame with Stoneeco or glass 6 mm thick inset, MDF and chipboard panels covered with walnut wood veneer

**Drawers' structure:** birch plywood / drawers runners with Blumotion technology

**Legs:** solid toulipier wood / solid walnut

**Legs ferrules and Mira handles:** brass

**Protective glides:** felt

Packaging	assembled	cbm.	kg.	not assembled	cbm.	kg.
Standard	●	0,72	95	●	0,56	95
Pallet	●	0,84	*	●	0,68	*
Wooden crate	●	1,12	*	●	0,92	*

\* weight to be confirmed

NAR 07G	Matt lacquered				Glossy lacquered				Matt walnut				Glossy walnut
	M001 M002 M003 M004 M005 M014	M006 M007 M011 M012 M013 M015 M018 M019	G001 G002 G003 G004 G005 G014	G006 G007 G011 G012 G013 G015 G018 G019	Natural Walnut NO.020.NA	Honey Walnut NO.020.MI	Tobacco Walnut NO.020.TA	Moro Walnut NO.020.MO	Tobacco Walnut NO.100.TA				
White glass	●	●	●	●	●	●	●	●	●				
Black glass	●	●	●	●	●	●	●	●	●				
Stoneeco Bianco Statuario	●	●	●	●	●	●	●	●	●				

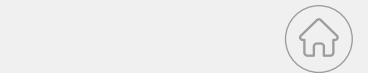
[GALLERY](#)
[NIGHT STORAGES](#)
[FINISHES](#)
[UPHOLSTERY](#)

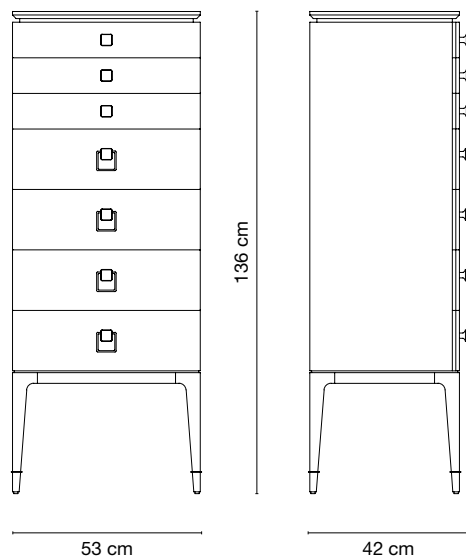

## Chest of 7 drawers

**TECHNICAL FEATURES**

**Top, structure and drawers' frontal:** solid toulipier wood frame with Stoneeco or glass 6 mm thick inset, MDF and chipboard panels / solid walnut frame with Stoneeco or glass 6 mm thick inset, MDF and chipboard panels covered with walnut wood veneer

**Drawers' structure:** birch plywood / drawers runners with Blumotion technology

**Legs:** solid toulipier wood / solid walnut

**Legs ferrules and Mira handles:** brass

**Protective glides:** felt

Packaging	assembled	cbm.	kg.	not assembled	cbm.	kg.
Standard	●	0,44	74	●	0,38	74
Pallet	●	0,48	*	●	0,42	*
Wooden crate	●	0,70	*	●	0,62	*

\* weight to be confirmed

NAR 09L	Matt lacquered				Glossy lacquered				Matt walnut				Glossy walnut
	M001 M002 M003 M004 M005 M014	M006 M007 M011 M012 M013 M015 M018 M019	G001 G002 G003 G004 G005 G014	G006 G007 G011 G012 G013 G015 G018 G019	Natural Walnut NO.020.NA	Honey Walnut NO.020.MI	Tobacco Walnut NO.020.TA	Moro Walnut NO.020.MO	Tobacco Walnut NO.100.TA				
White glass	●	●	●	●	●	●	●	●	●				
Black glass	●	●	●	●	●	●	●	●	●				
Stoneeco Bianco Statuario	●	●	●	●	●	●	●	●	●				



| GALLERY >

| NIGHT STORAGES >

| FINISHES >

| UPHOLSTERY >



Art Déco style and oriental scents of the old Japanese city Nara, to which the collection dedicates its name, are naturally fused in the design of this refined showcase. This careful blend of stylistic expressions, so different in the timing line and in the geographical provenience gives birth to a collection with a unique and incomparable style. The design with simple and sophisticated lines at the same time, the use of fine materials, the delicate play of contrast in the handles will give timeless sophistication and elegance to any interior.

**Structure finishes:** matt and glossy lacquer in the Galimberti Nino colour range / natural walnut / honey walnut / matt and glossy tobacco walnut / moro walnut  
**Legs' ferrules and Mira handles finishes:** bronze painted / satin brass with glossy inset  
**Glass finishes:** bronze

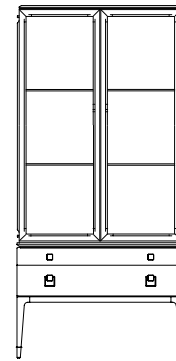



**NAR 93F**  
Showcase with drawers >



 | GALLERY >

 | STORAGES >

 | FINISHES >

 | UPHOLSTERY >

Showcase with drawers

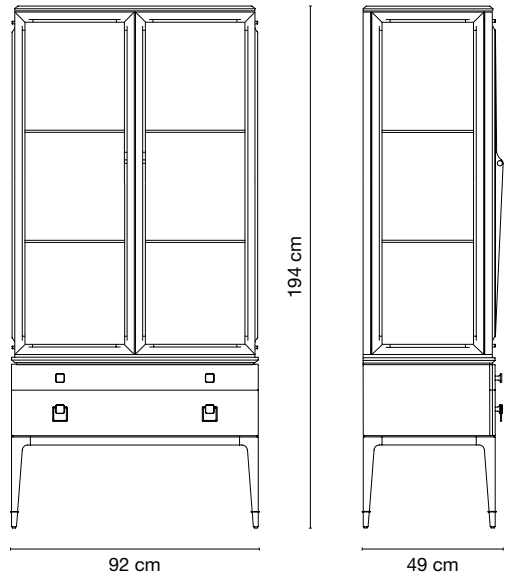

**TECHNICAL FEATURES**

**Top, structure and drawers' frontal:** solid toulipier wood frame, MDF and chipboard panels / solid walnut frame, MDF and chipboard panels covered with walnut wood veneer

**Drawers' structure:** birch plywood / drawers runners with Blumotion technology

**Glass doors:** toulipier solid wood frames and glass 4 mm thick / walnut solid wood frames and glass 4 mm thick

**Shelves:** glass 8 mm thick

**Legs:** solid toulipier wood / solid walnut

**Legs ferrules and Mira handles:** brass

**Protective glides:** felt

Packaging	assembled	cbm.	kg.	not assembled	cbm.	kg.
Standard	●	1,26	134	●	1,14	134
Pallet	●	1,46	*	●	1,34	*
Wooden crate	●	1,94	*	●	1,78	*

\* weight to be confirmed

NAR 93F	Matt lacquered				Glossy lacquered				Matt walnut				Glossy walnut
	M001 M002 M003 M004 M005 M014	M006 M007 M011 M012 M013 M015 M018 M019	G001 G002 G003 G004 G005 G014	G006 G007 G011 G012 G013 G015 G018 G019	Natural Walnut NO.020.NA	Honey Walnut NO.020.MI	Tobacco Walnut NO.020.TA	Moro Walnut NO.020.MO	Tobacco Walnut NO.100.TA				
	●	●	●	●	●	●	●	●	●				



| GALLERY >

| STORAGES >

| FINISHES >

| UPHOLSTERY >

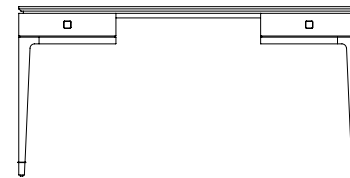

NAR 33P  
Desk

This splendid desk is part of the Nara collection, unique and unmistakable, with a surprising blend of oriental and western styles. The design that is both simple and sophisticated at the same time, the precious materials used for the creation of this prestigious piece of furniture, will give a timeless elegance to any home, both modern and classic one.

**Structure finishes:** matt and glossy lacquer in the Galimberti Nino colour range / natural walnut / honey walnut / matt and glossy tobacco walnut / moreo walnut

**Top's cover:** leather

**Legs' ferrules and Mira handles finishes:** bronze painted / satin brass with glossy inset

 | [VIEW ON WEBSITE](#) >

 | [GALLERY](#) >

 | [DESKS](#) >

 | [FINISHES](#) >

 | [UPHOLSTERY](#) >

Desk

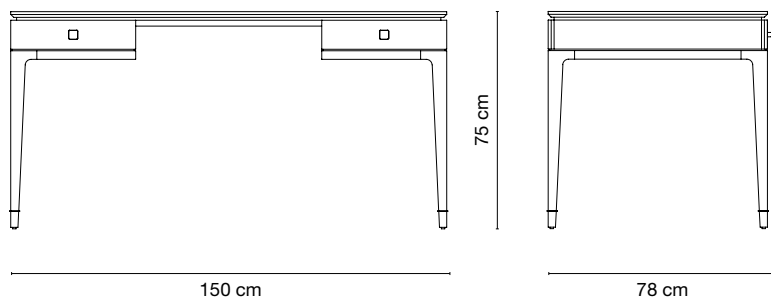

### TECHNICAL FEATURES

**Top, structure and drawers' frontal:** solid toulipier wood frame with leather inset, MDF and chipboard panels / solid walnut frame with leather inset, MDF and chipboard panels covered with walnut wood veneer

**Drawers' structure:** birch plywood / drawers runners with Blumotion technology

**Legs:** solid toulipier wood / solid walnut

**Legs ferrules and Mira handles:** brass

**Protective glides:** felt

Packaging	assembled	cbm.	kg.	not assembled	cbm.	kg.
Standard	●	0,94	96	●	0,48	96
Pallet	●	1,12	*	●	0,64	*
Wooden crate	●	1,42	*	●	0,86	*

\* weight to be confirmed

NAR 33P	Matt lacquered				Glossy lacquered				Matt walnut				Glossy walnut
	M001 M002 M003 M004 M005 M014	M006 M007 M011 M012 M013 M015 M018 M019	G001 G002 G003 G004 G005 G014	G006 G007 G011 G012 G013 G015 G018 G019	Natural Walnut NO.020.NA	Honey Walnut NO.020.MI	Tobacco Walnut NO.020.TA	Moro Walnut NO.020.MO	Tobacco Walnut NO.100.TA				
Leather	●	●	●	●	●	●	●	●	●				
Leather Lux	●	●	●	●	●	●	●	●	●				

- | GALLERY >
- | DESKS >
- | FINISHES >
- | UPHOLSTERY >



This splendid console is part of the Nara collection, unique and unmistakable, with a surprising blend of oriental and western styles. The design that is both simple and sophisticated at the same time, the precious materials used for the creation of this prestigious piece of furniture, will give a timeless elegance to any home, both modern and classic one.

**Top finishes:** glossy Bianco Statuario Stoneeco / white glass / black glass  
**Structure finishes:** matt and glossy lacquer in the Galimberti Nino colour range / natural walnut / honey walnut / matt and glossy tobacco walnut / moro walnut  
**Legs' ferrules and Mira handles finishes:** bronze painted / satin brass with glossy inset

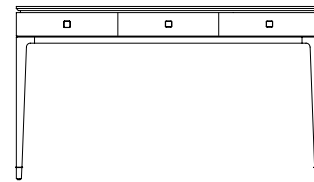



**NAR 45A**  
Console >



 | GALLERY >

 | CONSOLES >

 | FINISHES >

 | UPHOLSTERY >

Console

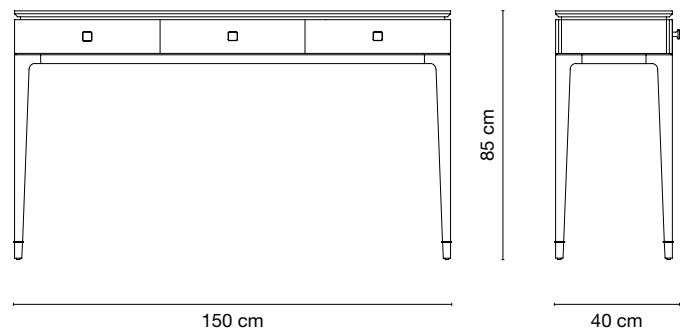

**TECHNICAL FEATURES**

**Top, structure and drawers' frontal:** solid toulipier wood frame with Stoneeco or glass 6 mm thick inset, MDF and chipboard panels / solid walnut frame with Stoneeco or glass 6 mm thick inset, MDF and chipboard panels covered with walnut wood veneer

**Drawers' structure:** birch plywood / drawers runners with Blumotion technology

**Legs:** solid toulipier wood / solid walnut

**Legs ferrules and Mira handles:** brass

**Protective glides:** felt

Packaging	assembled	cbm.	kg.	not assembled	cbm.	kg.
Standard	●	0,64	96	●	0,28	96
Pallet	●	0,74	*			
Wooden crate	●	1,00	*	●	0,56	*

\* weight to be confirmed

NAR 45A	Matt lacquered				Glossy lacquered				Matt walnut				Glossy walnut
	M001 M002 M003 M004 M005 M014	M006 M007 M011 M012 M013 M015 M018 M019	G001 G002 G003 G004 G005 G014	G006 G007 G011 G012 G013 G015 G018 G019	Natural Walnut NO.020.NA	Honey Walnut NO.020.MI	Tobacco Walnut NO.020.TA	Moro Walnut NO.020.MO	Tobacco Walnut NO.100.TA				
White glass	●	●	●	●	●	●	●	●	●				
Black glass	●	●	●	●	●	●	●	●	●				
Stoneeco Bianco Statuario	●	●	●	●	●	●	●	●	●				

- | GALLERY >
- | CONSOLES >
- | FINISHES >
- | UPHOLSTERY >



**NAR 67R**  
Bench

This splendid bench is part of the Nara collection, unique and unmistakable, with a surprising blend of oriental and western styles. The design that is both simple and sophisticated at the same time, the precious materials used for the creation of this prestigious piece of furniture, will give a timeless elegance to any home, both modern and classic one.

**Cover:** fabric / leather

**Structure finishes:** matt and glossy lacquer in the Galimberti Nino colour range / natural walnut / honey walnut / matt and glossy tobacco walnut / moro walnut

**Legs' ferrules finishes:** bronze painted / satin brass with glossy inset

 | GALLERY >

 | ARMCHAIRS AND OTTOMANS >

 | FINISHES >

 | UPHOLSTERY >



## Bench

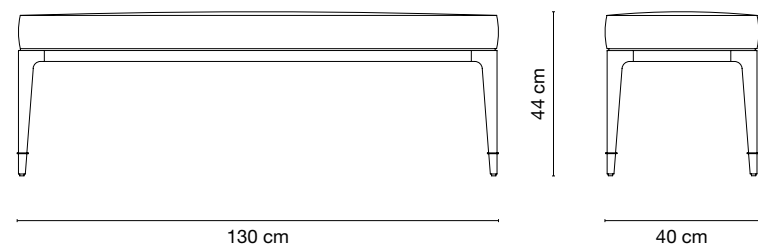

## TECHNICAL FEATURES

**Structure:** solid toulipier wood / solid walnut

**Seat:** plywood panel / padding in variable density high-resistance foam polyurethane / non-removable cover

**Legs ferrules:** brass

**Protective glides:** felt

Packaging	assembled	cbm.	kg.	not assembled	cbm.	kg.
Standard	●	0,32	18	●	0,20	18
Pallet	●	0,40	*	●	0,28	*
Wooden crate	●	0,56	*	●	0,40	*

\* weight to be confirmed

NAR 67R	Matt lacquered				Glossy lacquered				Matt walnut				Glossy walnut
	M001 M002 M003 M004 M005 M014	M006 M007 M011 M012 M013 M015 M018 M019	G001 G002 G003 G004 G005 G014	G006 G007 G011 G012 G013 G015 G018 G019	Natural Walnut NO.020.NA	Honey Walnut NO.020.MI	Tobacco Walnut NO.020.TA	Moro Walnut NO.020.MO	Tobacco Walnut NO.100.TA				
Customer's fabric mtl. 1,00	●	●	●	●	●	●	●	●	●				
Fabric cat. A	●	●	●	●	●	●	●	●	●				
Fabric cat. B	●	●	●	●	●	●	●	●	●				
Fabric cat. C	●	●	●	●	●	●	●	●	●				
Fabric cat. D	●	●	●	●	●	●	●	●	●				
Leather	●	●	●	●	●	●	●	●	●				
Leather Lux	●	●	●	●	●	●	●	●	●				

| GALLERY >

| ARMCHAIRS AND OTTOMANS >

| FINISHES >

| UPHOLSTERY >



The classic style and elegant forms blend to create an exceptional table that boasts functionality and refinement. The round top is supported by a grooved column raised on a crossed base, enriched with metal details. The perfect design to add timeless elegance to a contemporary home and fine craftsmanship of this table will make it the focal point of any ambience.

**Top and structure finishes:** matt and glossy lacquer in the Galimberti Nino colour range  
**Metal finishes:** bronze painted / satin brass

 | [VIEW ON WEBSITE](#) >

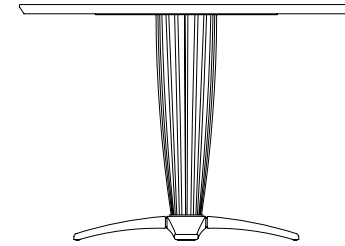

**ORL 18G**  
Dining table >

 | [GALLERY](#) >

 | [DINING TABLES](#) >

 | [FINISHES](#) >

 | [UPHOLSTERY](#) >

ORLANDO | Studio Galimberti - 2017

Dining table

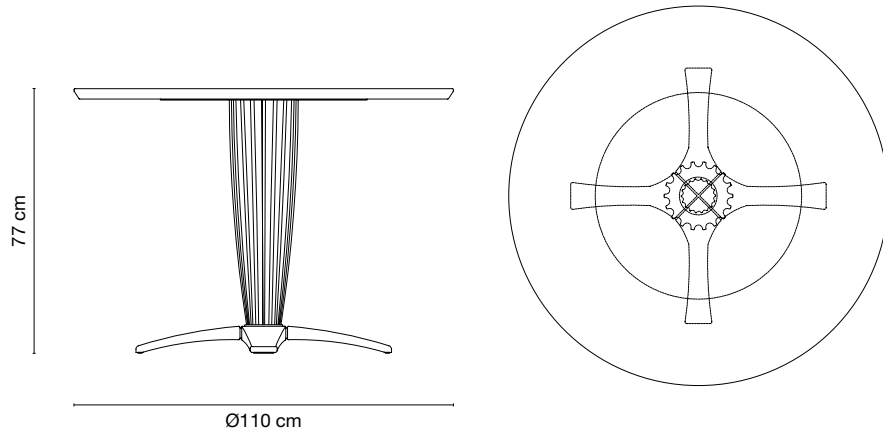

**TECHNICAL FEATURES**

**Top:** MDF panel

**Structure:** toulipier massive wood

**Metal insets:** brass

**Protective glides:** felt

Packaging	not assembled	cbm.	kg.
Standard	•	0,44	32
Pallet**	•	0,52	*
Wooden crate	•	0,84	*

\* weight to be confirmed \*\* top not included

ORL 18G	Matt lacquered				Glossy lacquered			
	M001 M002 M003 M004 M005 M014	M006 M007 M011 M012 M013 M015 M018 M019	G001 G002 G003 G004 G005 G014	G006 G007 G011 G012 G013 G015 G018 G019				
	•	•	•	•				



| GALLERY >

| DINING TABLES >

| FINISHES >

| UPHOLSTERY >

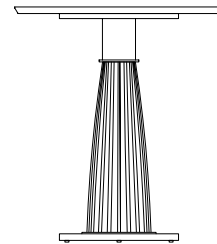

**ORL 14D**  
Side table Ø63

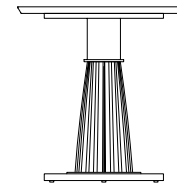

**ORL 15E**  
Side table Ø52

The coffee tables of the Orlando collection offer a precious and versatile exhibition area, while decorating a living room, an entrancehall or a study with traditional elegance. The round base supports a splendid fluted and sinuous column with the marble top. The metal inserts add a precious material contrast.

**Marble top finishes:** Bianco Carrara natural / Nero Marquinia natural / Breccia Medicea natural / Sahara Noir polyester / Patagonia natural

**Structure finishes:** matt and glossy lacquer in the Galimberti Nino colour range

**Metal finishes:** bronze painted / satin brass

| [VIEW ON WEBSITE](#) >

| [GALLERY](#) >

| [COFFEE AND SIDE TABLES](#) >

| [FINISHES](#) >

| [UPHOLSTERY](#) >

Side table Ø63

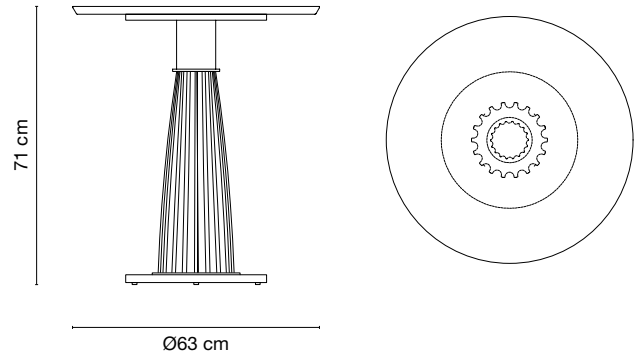
**TECHNICAL FEATURES****Top:** marble 20 mm thick coupled with a melamine chipboard panel**Undermount:** painted metal**Column:** solid toulipier wood**Base:** MDF panel**Metal insets:** brass**Protective glides:** felt

Packaging	not assembled	cbm.	kg.
Standard**	•	0,22	37
Wooden crate	•	0,34	*

\* weight to be confirmed \*\*marble in wooden crate packaging

ORL 14D	Matt lacquered				Glossy lacquered			
	M001 M002 M003 M004 M005 M014	M006 M007 M011 M012 M013 M015 M018 M019	G001 G002 G003 G004 G005 G014	G006 G007 G011 G012 G013 G015 G018 G019				
Bianco Carrara	•	•	•	•				
Nero Marquina	•	•	•	•				
Breccia Medicea	•	•	•	•				
Sahara Noir	•	•	•	•				
Patagonia	•	•	•	•				



| GALLERY &gt;

| COFFEE AND SIDE TABLES &gt;

| FINISHES &gt;

| UPHOLSTERY &gt;

# ORLANDO

 | Studio Galimberti - 2017

Side table Ø52

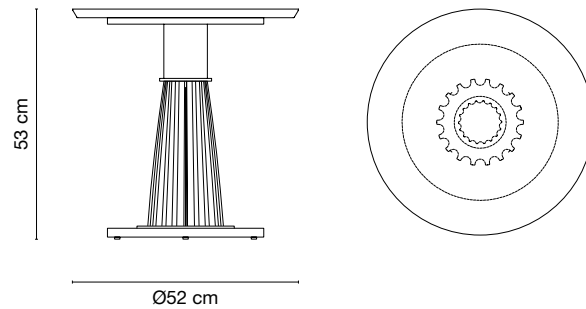
**TECHNICAL FEATURES****Top:** marble 20 mm thick coupled with a melamine chipboard panel**Undermount:** painted metal**Column:** solid toulipier wood**Base:** MDF panel**Metal insets:** brass**Protective glides:** felt

Packaging	not assembled	cbm.	kg.
Standard**	•	0,18	28
Wooden crate	•	0,28	*

\* weight to be confirmed \*\*marble in wooden crate packaging

ORL 15E	Matt lacquered				Glossy lacquered			
	M001 M002 M003 M004 M005 M014	M006 M007 M011 M012 M013 M015 M018 M019	G001 G002 G003 G004 G005 G014	G006 G007 G011 G012 G013 G015 G018 G019				
Bianco Carrara	•	•	•	•				
Nero Marquina	•	•	•	•				
Breccia Medicea	•	•	•	•				
Sahara Noir	•	•	•	•				
Patagonia	•	•	•	•				



| GALLERY &gt;

| COFFEE AND SIDE TABLES &gt;

| FINISHES &gt;

| UPHOLSTERY &gt;



The Orlando floor lamp will give a touch of incredible charm to any living room or study, and, combined with the tables of the same collection, it will fill a classic or modern home with sophisticated elegance. Its structure, adorned with refined metal inserts, features a sculptural column with vertical grooves that evoke the splendor of classical buildings.

**Structure finishes:** matt and glossy lacquer in the Galimberti Nino colour range

**Metal finishes:** bronze painted / satin brass

**Lampshade finish:** madreperla colour

 | [VIEW ON WEBSITE](#) >

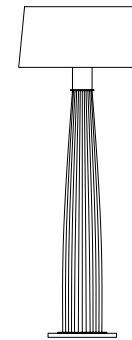



**ORL 16F**  
Floor lamp >



 | [GALLERY](#) >

 | [COMPLEMENTARY FURNITURE](#) >

 | [FINISHES](#) >

 | [UPHOLSTERY](#) >

Floor lamp

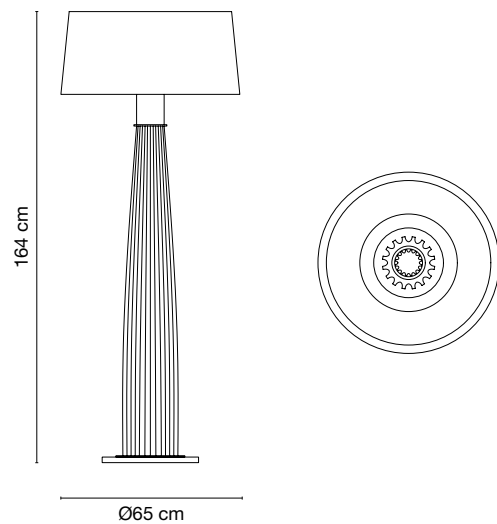

**TECHNICAL FEATURES**

**Column:** solid toulipier wood

**Base:** MDF panel

**Metal insets:** brass

**Protective glides:** felt

Packaging	not assembled	cbm.	kg.
Standard	•	0,50	23
Wooden crate	•	0,82	*

\* weight to be confirmed

ORL 16F	Matt lacquered				Glossy lacquered			
	M001 M002 M003 M004 M005 M014	M006 M007 M011 M012 M013 M015 M018 M019	G001 G002 G003 G004 G005 G014	G006 G007 G011 G012 G013 G015 G018 G019				
	•	•	•	•				



-  | GALLERY >
-  | COMPLEMENTARY FURNITURE >
-  | FINISHES >
-  | UPHOLSTERY >



# PETRO

 | Studio Galimberti - 2020

Proportions and linear shapes of these refined coffee and side tables make them perfectly suitable for any living room, providing a high sense of style while maintaining a delicate and timeless design. A decidedly balanced appearance characterized by precious details infuses refinement and elegance in both a classic and contemporary interior.

**Top finishes:** glossy Bianco Statuario Stoneeco / white glass / black glass

**Top and legs finishes:** matt and glossy lacquer in the Galimberti Nino colour range / natural walnut / honey walnut / matt and glossy tobacco walnut / moro walnut

**Legs' ferrules finishes:** bronze painted / satin brass

 | [VIEW ON WEBSITE](#) >



**PET 35H**  
Coffee table 120 >



**PET 34F**  
Coffee table 180 >



**PET 36L**  
Side table 50 h.40 >

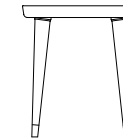

**PET 37M**  
Side table 50 h.56 >





**PET 38N**  
Side table 50 h.75 >



 | [GALLERY](#) >

 | [COFFEE AND SIDE TABLES](#) >

 | [FINISHES](#) >

 | [UPHOLSTERY](#) >

# PETRO

 | Studio Galimberti - 2020

Coffee table 120

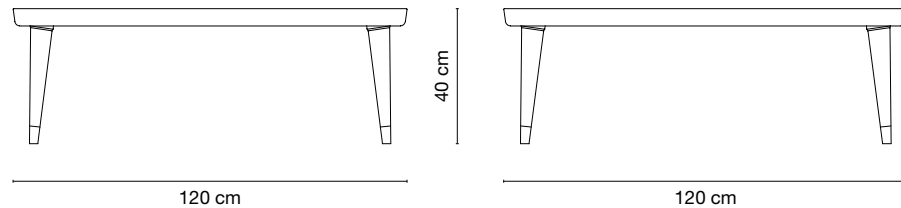
**TECHNICAL FEATURES**

**Top:** solid toulipier wood frame with Stoneeco or glass 6 mm thick inset coupled with an honeycomb MDF and plywood panel / solid walnut frame with Stoneeco or glass 6 mm thick inset coupled with an honeycomb MDF and plywood panel covered with walnut wood veneer

**Legs:** solid toulipier wood / solid walnut

**Legs ferrules:** brass

**Protective glides:** felt

Packaging	not assembled	cbm.	kg.
Standard	•	0,30	63
Wooden crate	•	0,58	*

\* weight to be confirmed

PET 35H	Matt lacquered				Glossy lacquered				Matt walnut				Glossy walnut
	M001 M002 M003 M004 M005 M014	M006 M007 M011 M012 M013 M015 M018 M019	G001 G002 G003 G004 G005 G014	G006 G007 G011 G012 G013 G015 G018 G019	Natural Walnut NO.020.NA	Honey Walnut NO.020.MI	Tobacco Walnut NO.020.TA	Moro Walnut NO.020.MO	Tobacco Walnut NO.100.TA				
White glass	•	•	•	•	•	•	•	•	•				
Black glass	•	•	•	•	•	•	•	•	•				
Stoneeco Bianco Statuario	•	•	•	•	•	•	•	•	•				

| GALLERY &gt;

| COFFEE AND SIDE TABLES &gt;

| FINISHES &gt;

| UPHOLSTERY &gt;

# PETRO

 | Studio Galimberti - 2020

Coffee table 180

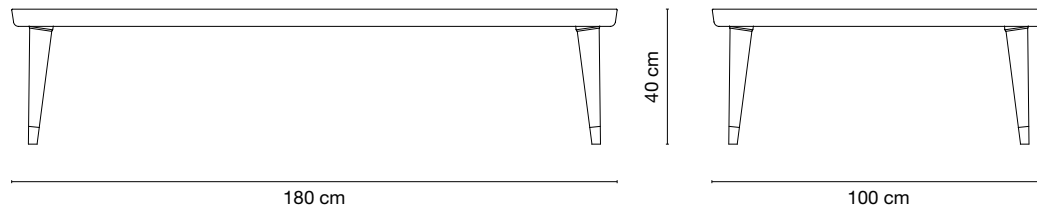
**TECHNICAL FEATURES**

**Top:** solid toulipier wood frame with Stoneeco or glass 6 mm thick inset coupled with an honeycomb MDF and plywood panel / solid walnut frame with Stoneeco or glass 6 mm thick inset coupled with an honeycomb MDF and plywood panel covered with walnut wood veneer

**Legs:** solid toulipier wood / solid walnut

**Legs ferrules:** brass

**Protective glides:** felt

Packaging	not assembled	cbm.	kg.
Standard	•	0,36	55
Wooden crate	•	0,74	*

\* weight to be confirmed

PET 34F	Matt lacquered				Glossy lacquered				Matt walnut				Glossy walnut
	M001 M002 M003 M004 M005 M014	M006 M007 M011 M012 M013 M015 M018 M019	G001 G002 G003 G004 G005 G014	G006 G007 G011 G012 G013 G015 G018 G019	Natural Walnut NO.020.NA	Honey Walnut NO.020.MI	Tobacco Walnut NO.020.TA	Moro Walnut NO.020.MO	Tobacco Walnut NO.100.TA				
White glass	•	•	•	•	•	•	•	•	•				
Black glass	•	•	•	•	•	•	•	•	•				
Stoneeco Bianco Statuario	•	•	•	•	•	•	•	•	•				

| GALLERY &gt;

| COFFEE AND SIDE TABLES &gt;

| FINISHES &gt;

| UPHOLSTERY &gt;

# PETRO

 | Studio Galimberti - 2020

Side table 50 h.40

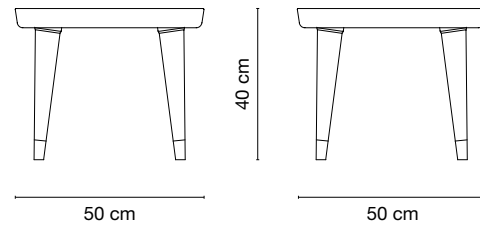
**TECHNICAL FEATURES**

**Top:** solid toulipier wood frame with Stoneeco or glass 6 mm thick inset coupled with a plywood panel / solid walnut frame with Stoneeco or glass 6 mm thick inset coupled with a plywood panel covered with walnut wood veneer

**Legs:** solid toulipier wood / solid walnut

**Legs ferrules:** brass

**Protective glides:** felt

Packaging	not assembled	cbm.	kg.
Standard	•	0,08	16
Wooden crate	•	0,20	*

\* weight to be confirmed

PET 36L	Matt lacquered				Glossy lacquered				Matt walnut				Glossy walnut
	M001 M002 M003 M004 M005 M014	M006 M007 M011 M012 M013 M015 M018 M019	G001 G002 G003 G004 G005 G014	G006 G007 G011 G012 G013 G015 G018 G019	Natural Walnut NO.020.NA	Honey Walnut NO.020.MI	Tobacco Walnut NO.020.TA	Moro Walnut NO.020.MO	Tobacco Walnut NO.100.TA				
White glass	•	•	•	•	•	•	•	•	•				
Black glass	•	•	•	•	•	•	•	•	•				
Stoneeco Bianco Statuario	•	•	•	•	•	•	•	•	•				

| GALLERY &gt;

| COFFEE AND SIDE TABLES &gt;

| FINISHES &gt;

| UPHOLSTERY &gt;

## PETRO

Studio Galimberti - 2020

Side table 50 h.56

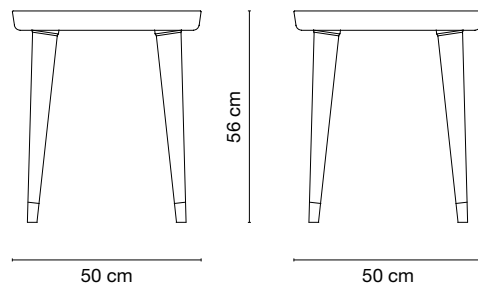

## TECHNICAL FEATURES

**Top:** solid toulipier wood frame with Stoneeco or glass 6 mm thick inset coupled with a plywood panel / solid walnut frame with Stoneeco or glass 6 mm thick inset coupled with a plywood panel covered with walnut wood veneer

**Legs:** solid toulipier wood / solid walnut

**Legs ferrules:** brass

**Protective glides:** felt

Packaging	not assembled	cbm.	kg.
Standard	•	0,08	17
Wooden crate	•	0,20	*

\* weight to be confirmed

PET 37M	Matt lacquered				Glossy lacquered				Matt walnut				Glossy walnut
	M001 M002 M003 M004 M005 M014	M006 M007 M011 M012 M013 M015 M018 M019	G001 G002 G003 G004 G005 G014	G006 G007 G011 G012 G013 G015 G018 G019	Natural Walnut NO.020.NA	Honey Walnut NO.020.MI	Tobacco Walnut NO.020.TA	Moro Walnut NO.020.MO	Tobacco Walnut NO.100.TA				
White glass	•	•	•	•	•	•	•	•	•				
Black glass	•	•	•	•	•	•	•	•	•				
Stoneeco Bianco Statuario	•	•	•	•	•	•	•	•	•				

| GALLERY &gt;

| COFFEE AND SIDE TABLES &gt;

| FINISHES &gt;

| UPHOLSTERY &gt;

# PETRO

 | Studio Galimberti - 2020

Side table 50 h.75

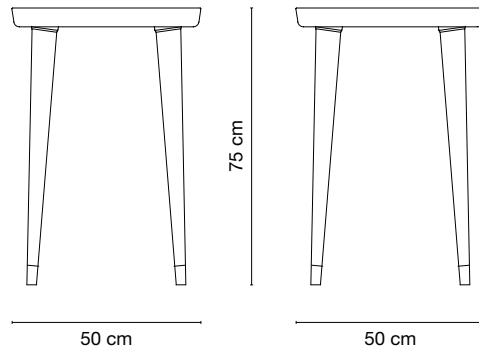
**TECHNICAL FEATURES**

**Top:** solid toulipier wood frame with Stoneeco or glass 6 mm thick inset coupled with a plywood panel / solid walnut frame with Stoneeco or glass 6 mm thick inset coupled with a plywood panel covered with walnut wood veneer

**Legs:** solid toulipier wood / solid walnut

**Legs ferrules:** brass

**Protective glides:** felt

Packaging	not assembled	cbm.	kg.
Standard	•	0,12	18
Wooden crate	•	0,26	*

\* weight to be confirmed

PET 38N	Matt lacquered				Glossy lacquered				Matt walnut				Glossy walnut
	M001 M002 M003 M004 M005 M014	M006 M007 M011 M012 M013 M015 M018 M019	G001 G002 G003 G004 G005 G014	G006 G007 G011 G012 G013 G015 G018 G019	Natural Walnut NO.020.NA	Honey Walnut NO.020.MI	Tobacco Walnut NO.020.TA	Moro Walnut NO.020.MO	Tobacco Walnut NO.100.TA				
White glass	•	•	•	•	•	•	•	•	•				
Black glass	•	•	•	•	•	•	•	•	•				
Stoneeco Bianco Statuario	•	•	•	•	•	•	•	•	•				

 | GALLERY >

 | COFFEE AND SIDE TABLES >

 | FINISHES >

 | UPHOLSTERY >

# PETRO

 | Studio Galimberti - 2020

Proportions and linear shapes of these refined consoles make them perfectly suitable for any living room, providing a high sense of style while maintaining a delicate and timeless design. A decidedly balanced appearance characterized by precious details infuses refinement and elegance in both a classic and contemporary interior.

**Top finishes:** glossy Bianco Statuario Stoneeco / white glass / black glass

**Top and legs finishes:** matt and glossy lacquer in the Galimberti Nino colour range / natural walnut / honey walnut / matt and glossy tobacco walnut / moro walnut

**Legs' ferrules finishes:** bronze painted / satin brass

| [VIEW ON WEBSITE](#) >



**PET 12E**  
Console 120 h.40 >



**PET 12D**  
Console 120 h.56 >



**PET 12B**  
Console 120 h.75 >



**PET 42T**  
Console 180 h.40 >



**PET 41S**  
Console 180 h.56 >



**PET 40P**  
Console 180 h.75 >

| [GALLERY](#) >

| [CONSOLES](#) >

| [FINISHES](#) >

| [UPHOLSTERY](#) >

# PETRO

 | Studio Galimberti - 2020

Console 120 h.40

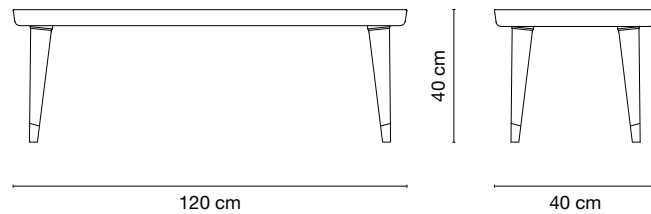
**TECHNICAL FEATURES**

**Top:** solid toulipier wood frame with Stoneeco or glass 6 mm thick inset coupled with a plywood panel / solid walnut frame with Stoneeco or glass 6 mm thick inset coupled with a plywood panel covered with walnut wood veneer

**Legs:** solid toulipier wood / solid walnut

**Legs ferrules:** brass

**Protective glides:** felt

Packaging	not assembled	cbm.	kg.
Standard	•	0,14	26
Wooden crate	•	0,32	*

\* weight to be confirmed

PET 12E	Matt lacquered				Glossy lacquered				Matt walnut				Glossy walnut
	M001 M002 M003 M004 M005 M014	M006 M007 M011 M012 M013 M015 M018 M019	G001 G002 G003 G004 G005 G014	G006 G007 G011 G012 G013 G015 G018 G019	Natural Walnut NO.020.NA	Honey Walnut NO.020.MI	Tobacco Walnut NO.020.TA	Moro Walnut NO.020.MO	Tobacco Walnut NO.100.TA				
White glass	•	•	•	•	•	•	•	•	•				
Black glass	•	•	•	•	•	•	•	•	•				
Stoneeco Bianco Statuario	•	•	•	•	•	•	•	•	•				

| GALLERY &gt;

| CONSOLES &gt;

| FINISHES &gt;

| UPHOLSTERY &gt;



## PETRO

Studio Galimberti - 2020

Console 120 h.56

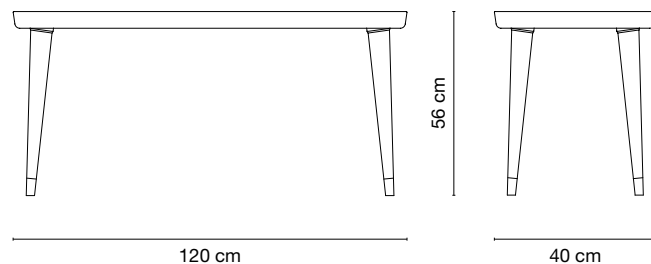

## TECHNICAL FEATURES

**Top:** solid toulipier wood frame with Stoneeco or glass 6 mm thick inset coupled with a plywood panel / solid walnut frame with Stoneeco or glass 6 mm thick inset coupled with a plywood panel covered with walnut wood veneer

**Legs:** solid toulipier wood / solid walnut

**Legs ferrules:** brass

**Protective glides:** felt

Packaging	not assembled	cbm.	kg.
Standard	•	0,14	27
Wooden crate	•	0,32	*

\* weight to be confirmed

PET 12D	Matt lacquered				Glossy lacquered				Matt walnut				Glossy walnut
	M001 M002 M003 M004 M005 M014	M006 M007 M011 M012 M013 M015 M018 M019	G001 G002 G003 G004 G005 G014	G006 G007 G011 G012 G013 G015 G018 G019	Natural Walnut NO.020.NA	Honey Walnut NO.020.MI	Tobacco Walnut NO.020.TA	Moro Walnut NO.020.MO	Tobacco Walnut NO.100.TA				
White glass	•	•	•	•	•	•	•	•	•				
Black glass	•	•	•	•	•	•	•	•	•				
Stoneeco Bianco Statuario	•	•	•	•	•	•	•	•	•				

| GALLERY &gt;

| CONSOLES &gt;

| FINISHES &gt;

| UPHOLSTERY &gt;

# PETRO

 | Studio Galimberti - 2020

Console 120 h.75

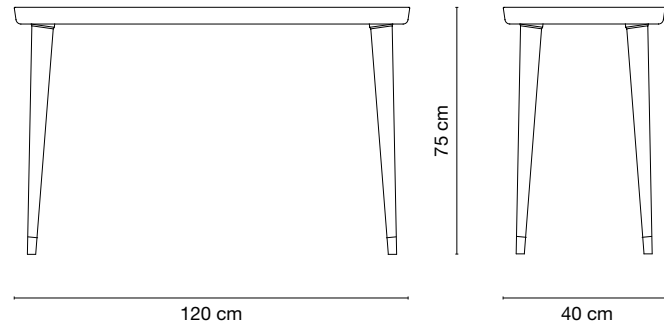
**TECHNICAL FEATURES**

**Top:** solid toulipier wood frame with Stoneeco or glass 6 mm thick inset coupled with a plywood panel / solid walnut frame with Stoneeco or glass 6 mm thick inset coupled with a plywood panel covered with walnut wood veneer

**Legs:** solid toulipier wood / solid walnut

**Legs ferrules:** brass

**Protective glides:** felt

Packaging	not assembled	cbm.	kg.
Standard	•	0,14	28
Wooden crate	•	0,32	*

\* weight to be confirmed

PET 12B	Matt lacquered				Glossy lacquered				Matt walnut				Glossy walnut
	M001 M002 M003 M004 M005 M014	M006 M007 M011 M012 M013 M015 M018 M019	G001 G002 G003 G004 G005 G014	G006 G007 G011 G012 G013 G015 G018 G019	Natural Walnut NO.020.NA	Honey Walnut NO.020.MI	Tobacco Walnut NO.020.TA	Moro Walnut NO.020.MO	Tobacco Walnut NO.100.TA				
White glass	•	•	•	•	•	•	•	•	•				
Black glass	•	•	•	•	•	•	•	•	•				
Stoneeco Bianco Statuario	•	•	•	•	•	•	•	•	•				

| GALLERY &gt;

| CONSOLES &gt;

| FINISHES &gt;

| UPHOLSTERY &gt;

## PETRO

Studio Galimberti - 2020

Console 180 h.40

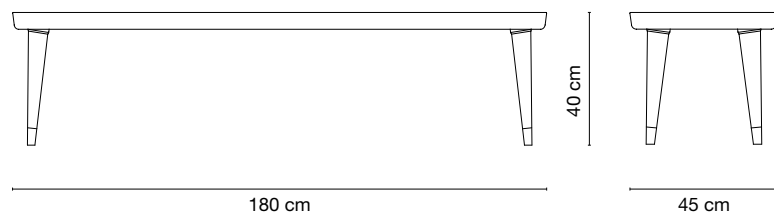

## TECHNICAL FEATURES

**Top:** solid toulipier wood frame with Stoneeco or glass 6 mm thick inset coupled with a plywood panel / solid walnut frame with Stoneeco or glass 6 mm thick inset coupled with a plywood panel covered with walnut wood veneer

**Legs:** solid toulipier wood / solid walnut

**Legs ferrules:** brass

**Protective glides:** felt

Packaging	not assembled	cbm.	kg.
Standard	•	0,20	35
Wooden crate	•	0,46	*

\* weight to be confirmed

PET 42T	Matt lacquered				Glossy lacquered				Matt walnut				Glossy walnut
	M001 M002 M003 M004 M005 M014	M006 M007 M011 M012 M013 M015 M018 M019	G001 G002 G003 G004 G005 G014	G006 G007 G011 G012 G013 G015 G018 G019	Natural Walnut NO.020.NA	Honey Walnut NO.020.MI	Tobacco Walnut NO.020.TA	Moro Walnut NO.020.MO	Tobacco Walnut NO.100.TA				
White glass	•	•	•	•	•	•	•	•	•				
Black glass	•	•	•	•	•	•	•	•	•				
Stoneeco Bianco Statuario	•	•	•	•	•	•	•	•	•				

| GALLERY &gt;

| CONSOLES &gt;

| FINISHES &gt;

| UPHOLSTERY &gt;

# PETRO

 | Studio Galimberti - 2020

Console 180 h.56

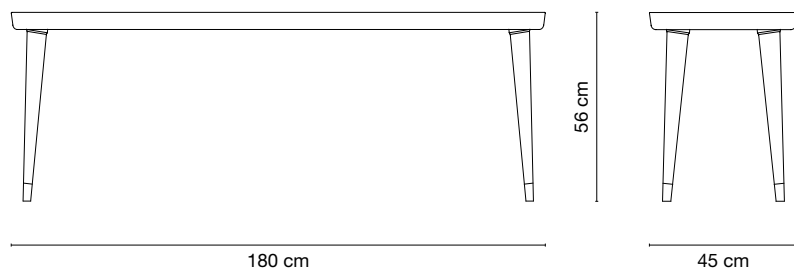
**TECHNICAL FEATURES**

**Top:** solid toulipier wood frame with Stoneeco or glass 6 mm thick inset coupled with a plywood panel / solid walnut frame with Stoneeco or glass 6 mm thick inset coupled with a plywood panel covered with walnut wood veneer

**Legs:** solid toulipier wood / solid walnut

**Legs ferrules:** brass

**Protective glides:** felt

Packaging	not assembled	cbm.	kg.
Standard	•	0,20	36
Wooden crate	•	0,46	*

\* weight to be confirmed

PET 41S	Matt lacquered				Glossy lacquered				Matt walnut				Glossy walnut
	M001 M002 M003 M004 M005 M014	M006 M007 M011 M012 M013 M015 M018 M019	G001 G002 G003 G004 G005 G014	G006 G007 G011 G012 G013 G015 G018 G019	Natural Walnut NO.020.NA	Honey Walnut NO.020.MI	Tobacco Walnut NO.020.TA	Moro Walnut NO.020.MO	Tobacco Walnut NO.100.TA				
White glass	•	•	•	•	•	•	•	•	•				
Black glass	•	•	•	•	•	•	•	•	•				
Stoneeco Bianco Statuario	•	•	•	•	•	•	•	•	•				

| GALLERY &gt;

| CONSOLES &gt;

| FINISHES &gt;

| UPHOLSTERY &gt;

**PETRO** | Studio Galimberti - 2020

Console 180 h.75

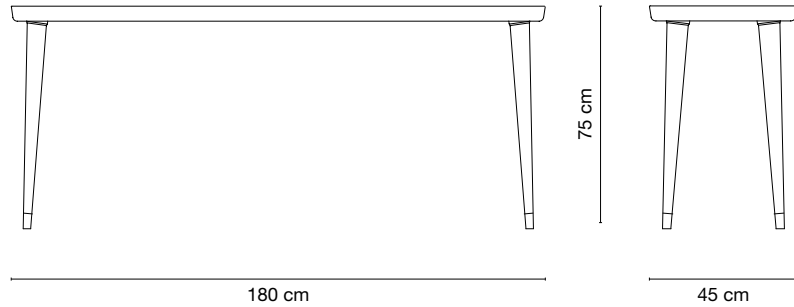

**TECHNICAL FEATURES**

**Top:** solid toulipier wood frame with Stoneeco or glass 6 mm thick inset coupled with a plywood panel / solid walnut frame with Stoneeco or glass 6 mm thick inset coupled with a plywood panel covered with walnut wood veneer

**Legs:** solid toulipier wood / solid walnut





**Legs ferrules:** brass

**Protective glides:** felt

Packaging	not assembled	cbm.	kg.
Standard	•	0,20	37
Wooden crate	•	0,46	*

\* weight to be confirmed

PET 40P	Matt lacquered				Glossy lacquered				Matt walnut				Glossy walnut
	M001 M002 M003 M004 M005 M014	M006 M007 M011 M012 M013 M015 M018 M019	G001 G002 G003 G004 G005 G014	G006 G007 G011 G012 G013 G015 G018 G019	Natural Walnut NO.020.NA	Honey Walnut NO.020.MI	Tobacco Walnut NO.020.TA	Moro Walnut NO.020.MO	Tobacco Walnut NO.100.TA				
White glass	•	•	•	•	•	•	•	•	•				
Black glass	•	•	•	•	•	•	•	•	•				
Stoneeco Bianco Statuario	•	•	•	•	•	•	•	•	•				

-  | GALLERY >
-  | CONSOLES >
-  | FINISHES >
-  | UPHOLSTERY >

## PIGRONE | Studio Galimberti - 2012



With its timeless and sophisticated design, Pigrone represents a splendid touch of refined aesthetics both in an entrance hall and in a living room with a classic or contemporary taste. Its sinuous and elegant shapes, the important backrest, the soft armrests and the generous seat express the ability to be attractive and comfortable at any time when you simply feel the need to relax or to share joyfully your time with the others.

**Covers:** fabric

**Structure finishes:** white ash wood / tobacco ash wood / moro ash wood / ebonized ash wood

**Studs finish:** patinated gold

 | [VIEW ON WEBSITE](#) >

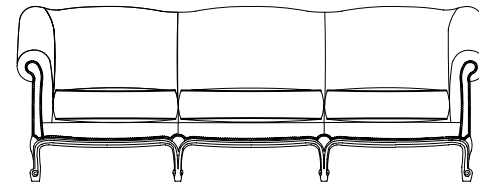

**PGE 41A**  
Sofa >

 | [GALLERY](#) >

 | [SOFAS](#) >

 | [FINISHES](#) >

 | [UPHOLSTERY](#) >

## PIGRONE | Studio Galimberti - 2012

Sofa

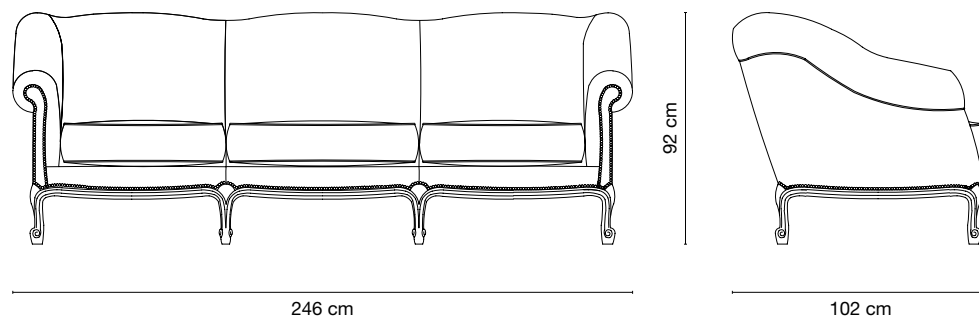
**TECHNICAL FEATURES****Structure:** solid ash wood**Seat and backrest:** padding in variable density high-resistance foam polyurethane / seat with elastic straps / non-removable cover**Cushions:** goose down divided into sections with high-resistance foam polyurethane inset and polyester fiber lining / removable cover**Studs:** metal**Protective glides:** felt

Packaging	assembled	cbm.	kg.
Standard	●	2,68	82
Pallet	●	3,08	*
Wooden crate	●	3,66	*

\* weight to be confirmed

PGE 41A	Ash wood			
	White FR.020.BI	Tobacco FR.020.TA	Moro FR.020.MO	Ebonized FR.020.EB
Customer's fabric mtl. 14,00	●	●	●	●
Fabric cat. A	●	●	●	●
Fabric cat. B	●	●	●	●
Fabric cat. C	●	●	●	●
Fabric cat. D	●	●	●	●

 | GALLERY >

 | SOFAS >

 | FINISHES >

 | UPHOLSTERY >

## PIGRONE | Studio Galimberti - 2012



With its timeless and sophisticated design, Pigrone represents a splendid touch of refined aesthetics both in an entrance hall and in a living room with a classic or contemporary taste. Its sinuous and elegant shapes, the important backrest, the soft armrests and the generous seat express the ability to be attractive and comfortable at any time when you simply feel the need to relax or to share joyfully your time with the others.

**Covers:** fabric

**Structure finishes:** white ash wood / tobacco ash wood / moro ash wood / ebonized ash wood

**Studs finish:** patinated gold

 | [VIEW ON WEBSITE](#) >

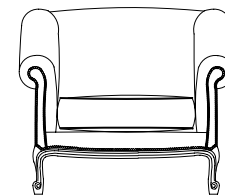



**PGE 42B**  
Club chair >



 | [GALLERY](#) >

 | [ARMCHAIRS AND OTTOMANS](#) >

 | [FINISHES](#) >

 | [UPHOLSTERY](#) >



## PIGRONE | Studio Galimberti - 2012

Club chair

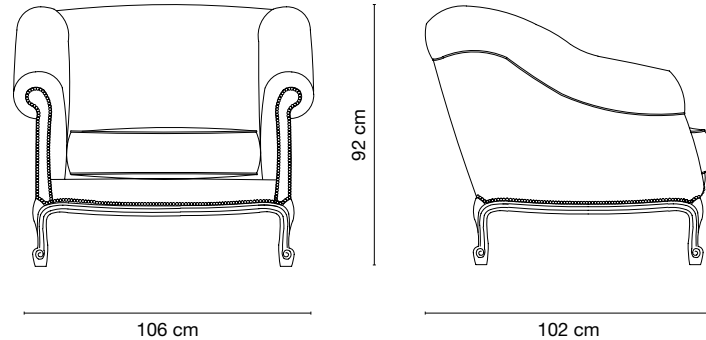
**TECHNICAL FEATURES****Structure:** solid ash wood**Seat and backrest:** padding in variable density high-resistance foam polyurethane / seat with elastic straps / non-removable cover**Cushion:** goose down divided into sections with high-resistance foam polyurethane inset and polyester fiber lining / removable cover**Studs:** metal**Protective glides:** felt

Packaging	assembled	cbm.	kg.
Standard	●	1,22	41
Pallet	●	1,40	*
Wooden crate	●	1,74	*

\* weight to be confirmed

PGE 42B	Ash wood			
	White FR.020.BI	Tobacco FR.020.TA	Moro FR.020.MO	Ebonized FR.020.EB
Customer's fabric mtl. 6,50	●	●	●	●
Fabric cat. A	●	●	●	●
Fabric cat. B	●	●	●	●
Fabric cat. C	●	●	●	●
Fabric cat. D	●	●	●	●



| GALLERY &gt;

| ARMCHAIRS AND OTTOMANS &gt;

| FINISHES &gt;

| UPHOLSTERY &gt;

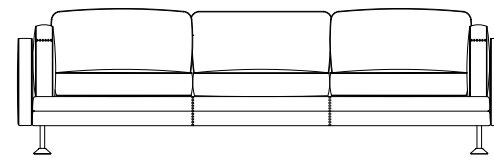

**QUN 31B**  
3 seat sofa





A rigorous and clean shape with a square appearance softened by the cozy cushions, the Quinto sofa recalls the clean and minimal lines of Nordic design. A clear and sincere piece in its simplicity but characterized by a timeless style that will fill with charm any environment where it's placed.

**Covers:** fabric / leather  
**Legs finishes:** matt black

 | [VIEW ON WEBSITE](#) >

 | [GALLERY](#) >

 | [SOFAS](#) >

 | [FINISHES](#) >

 | [UPHOLSTERY](#) >

# QUINTO

 | Studio Galimberti - 2019

3 seat sofa

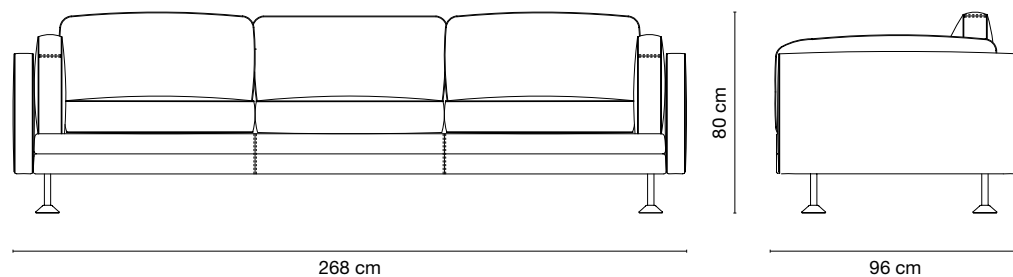
**TECHNICAL FEATURES****Structure:** solid wood and plywood panels**Seat and backrest:** padding in variable density high-resistance foam polyurethane / seat with elastic straps / non-removable cover**Cushions:** goose down divided into sections with polyurethane inset / removable cover**Legs:** painted metal**Piping:** gros grain**Protective glides:** soft non-scratch rubber

Packaging	assembled	cbm.	kg.	not assembled	cbm.	kg.
Standard	●	1,94	107	●	1,52	107
Pallet	●	2,34	*	●	1,94	*
Wooden crate	●	2,84	*	●	2,36	*

\* weight to be confirmed

QUN 31B	Metal	
	Matt Black ME.NER.20	
Customer's fabric mtl. 18,00	●	
Fabric cat. A	●	
Fabric cat. B	●	
Fabric cat. C	●	
Fabric cat. D	●	
Leather	●	
Leather Lux	●	



| GALLERY &gt;

| SOFAS &gt;

| FINISHES &gt;

| UPHOLSTERY &gt;

### MODULAR SOFAS



A rigorous and clean shape with a square appearance softened by the cozy cushions, the Quinto modular sofas recall the clean and minimal lines of Nordic design. A clear and sincere piece in its simplicity but characterized by a timeless style that will fill with charm any environment where it's placed.

**Covers:** fabric / leather  
**Legs finishes:** matt black

 | [VIEW ON WEBSITE](#) >

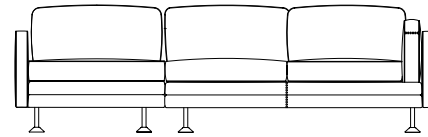

**QUN C11**  
Modular sofa 268x192  
with SX chaise longue >

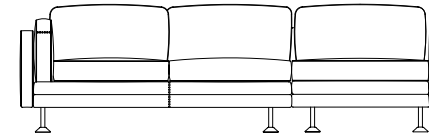

**QUN C22**  
Modular sofa 268x192  
with DX chaise longue >

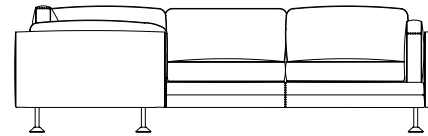

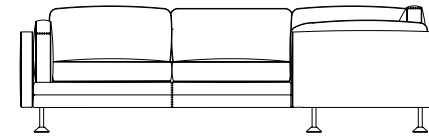

**QUN C66**  
Modular sofa 268x268 SX >





**QUN C77**  
Modular sofa 268x268 DX >



 | [GALLERY](#) >

 | [SOFAS](#) >

 | [FINISHES](#) >

 | [UPHOLSTERY](#) >

# QUINTO

 | Studio Galimberti - 2019

Modular sofa 268x192 with SX chaise longue

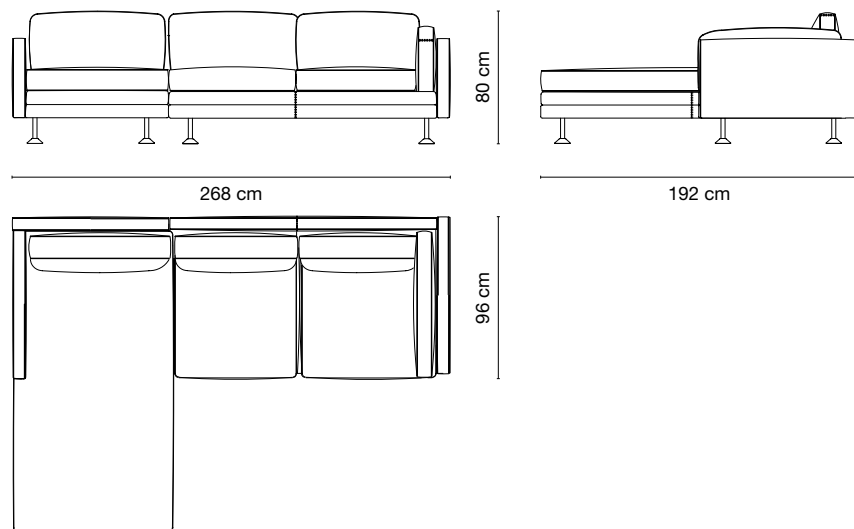

## TECHNICAL FEATURES

**Structure:** solid wood and plywood panels

**Seat and backrest:** padding in variable density high-resistance foam polyurethane / seat with elastic straps / non-removable cover

**Cushions:** goose down divided into sections with polyurethane inset / removable cover

**Legs:** painted metal

**Piping:** gros grain

**Protective glides:** soft non-scratch rubber

Packaging	assembled	cbm.	kg.	not assembled	cbm.	kg.
Standard	●	2,66	144	●	2,10	144
Pallet	●	3,24	*	●	2,66	*
Wooden crate	●	3,98	*	●	3,32	*

\* weight to be confirmed

QUN C11	Metal	
	Matt Black ME.NER.20	
Customer's fabric mtl. 26,50	●	
Fabric cat. A	●	
Fabric cat. B	●	
Fabric cat. C	●	
Fabric cat. D	●	
Leather	●	
Leather Lux	●	



| GALLERY >

| SOFAS >

| FINISHES >

| UPHOLSTERY >

# QUINTO

 | Studio Galimberti - 2019

Modular sofa 268x192 with DX chaise longue

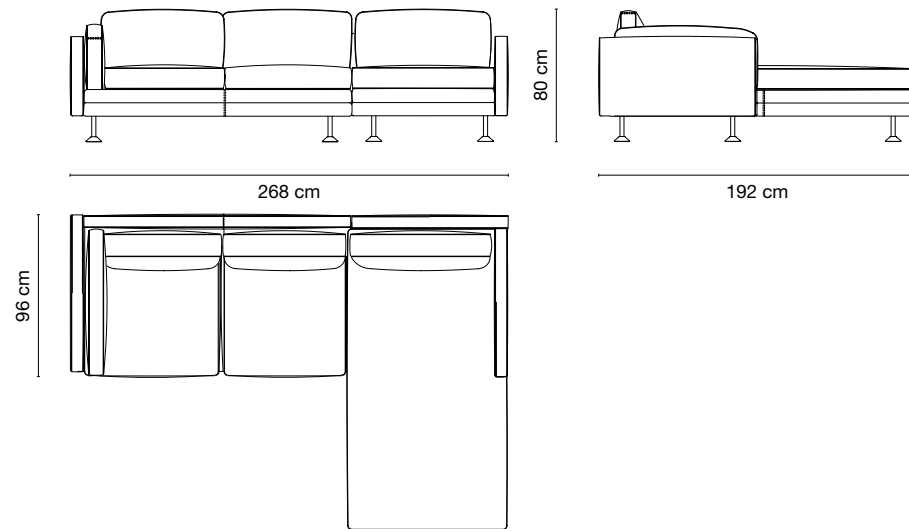

### TECHNICAL FEATURES

**Structure:** solid wood and plywood panels

**Seat and backrest:** padding in variable density high-resistance foam polyurethane / seat with elastic straps / non-removable cover

**Cushions:** goose down divided into sections with polyurethane inset / removable cover

**Legs:** painted metal

**Piping:** gros grain

**Protective glides:** soft non-scratch rubber

Packaging	assembled	cbm.	kg.	not assembled	cbm.	kg.
Standard	●	2,66	144	●	2,10	144
Pallet	●	3,24	*	●	2,66	*
Wooden crate	●	3,98	*	●	3,32	*

\* weight to be confirmed

QUN C22	Metal	
	Matt Black ME.NER.20	
Customer's fabric mtl. 26,50	●	
Fabric cat. A	●	
Fabric cat. B	●	
Fabric cat. C	●	
Fabric cat. D	●	
Leather	●	
Leather Lux	●	



| GALLERY >

| SOFAS >

| FINISHES >

| UPHOLSTERY >

# QUINTO

 | Studio Galimberti - 2019

Modular sofa 268x268 SX

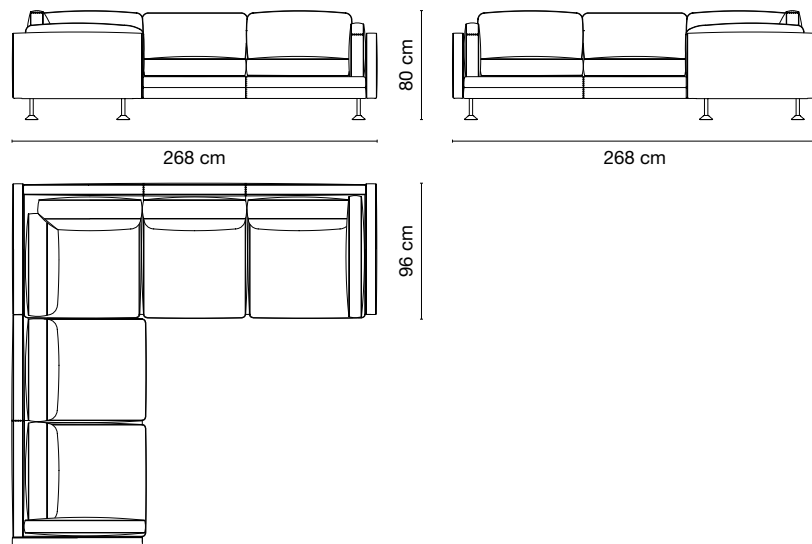
**TECHNICAL FEATURES****Structure:** solid wood and plywood panels**Seat and backrest:** padding in variable density high-resistance foam polyurethane / seat with elastic straps / non-removable cover**Cushions:** goose down divided into sections with polyurethane inset / removable cover**Legs:** painted metal**Piping:** gros grain**Protective glides:** soft non-scratch rubber

Packaging	assembled	cbm.	kg.	not assembled	cbm.	kg.
Standard	●	3,20	179	●	2,52	179
Pallet	●	3,88	*	●	3,20	*
Wooden crate	●	4,74	*	●	3,94	*

*\* weight to be confirmed*

QUN C66	Metal	
	Matt Black ME.NER.20	
Customer's fabric mtl. 32,50	●	
Fabric cat. A	●	
Fabric cat. B	●	
Fabric cat. C	●	
Fabric cat. D	●	
Leather	●	
Leather Lux	●	



| GALLERY &gt;

| SOFAS &gt;

| FINISHES &gt;

| UPHOLSTERY &gt;

# QUINTO

 | Studio Galimberti - 2019

Modular sofa 268x268 DX

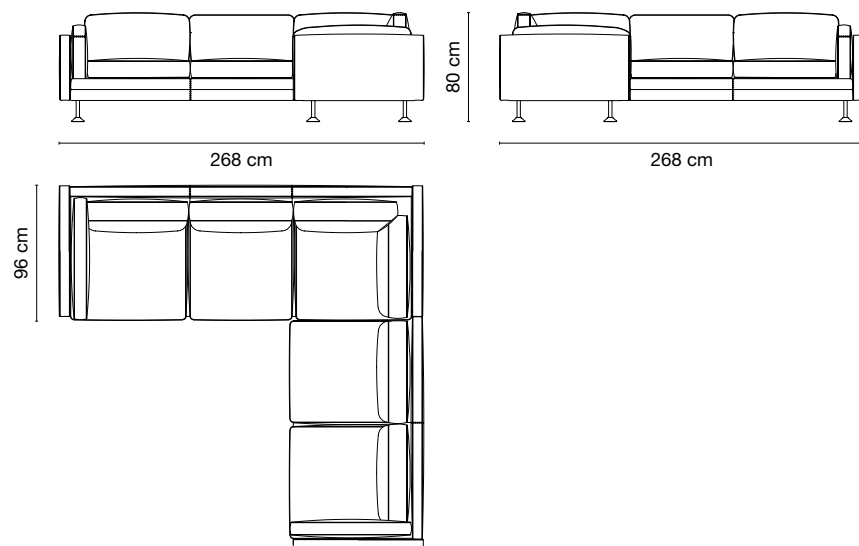
**TECHNICAL FEATURES****Structure:** solid wood and plywood panels**Seat and backrest:** padding in variable density high-resistance foam polyurethane / seat with elastic straps / non-removable cover**Cushions:** goose down divided into sections with polyurethane inset / removable cover**Legs:** painted metal**Piping:** gros grain**Protective glides:** soft non-scratch rubber

Packaging	assembled	cbm.	kg.	not assembled	cbm.	kg.
Standard	●	3,20	179	●	2,52	179
Pallet	●	3,88	*	●	3,20	*
Wooden crate	●	4,74	*	●	3,94	*

*\* weight to be confirmed*

QUN C77	Metal	
	Matt Black ME.NER.20	
Customer's fabric mtl. 32,50	●	
Fabric cat. A	●	
Fabric cat. B	●	
Fabric cat. C	●	
Fabric cat. D	●	
Leather	●	
Leather Lux	●	

[GALLERY](#) >

[SOFAS](#) >

[FINISHES](#) >

[UPHOLSTERY](#) >



### CHAISES LONGUES



A rigorous and clean shape with a square appearance softened by the cozy cushions, the Quinto chaises longues recall the clean and minimal lines of Nordic design. A clear and sincere piece in its simplicity but characterized by a timeless style that will fill with charm any environment where it's placed.

**Covers:** fabric / leather  
**Legs finishes:** matt black

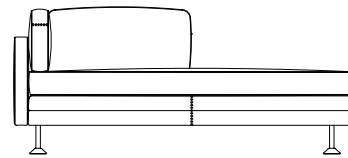

**QUN 42D**  
Chaise longue DX

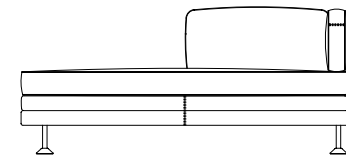



**QUN 43E**  
Chaise longue SX

 | [VIEW ON WEBSITE](#) >



 | [GALLERY](#) >

 | [SOFAS](#) >

 | [FINISHES](#) >

 | [UPHOLSTERY](#) >

# QUINTO | Studio Galimberti - 2019

Chaise longue DX

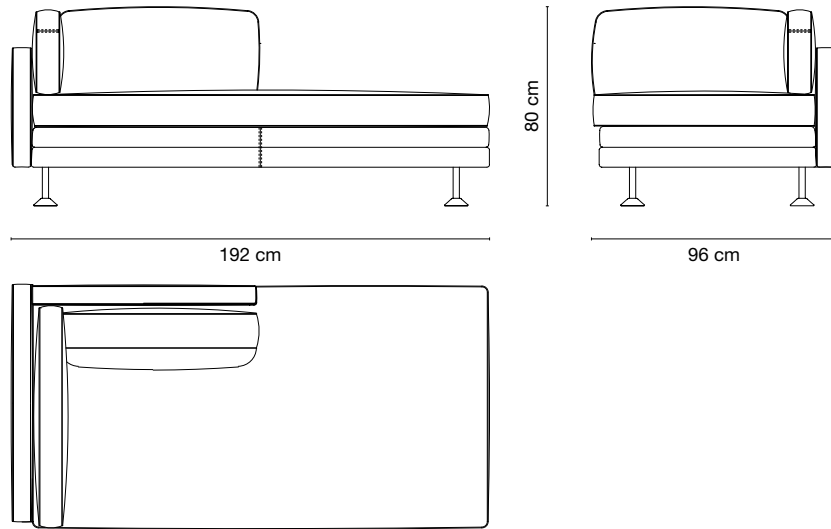
**TECHNICAL FEATURES****Structure:** solid wood and plywood panels**Seat and backrest:** padding in variable density high-resistance foam polyurethane / seat with elastic straps / non-removable cover**Cushions:** goose down divided into sections with polyurethane inset / removable cover**Legs:** painted metal**Piping:** gros grain**Protective glides:** soft non-scratch rubber

Packaging	assembled	cbm.	kg.	not assembled	cbm.	kg.
Standard	●	1,40	72	●	1,10	72
Pallet	●	1,70	*	●	1,40	*
Wooden crate	●	2,08	*	●	1,74	*

\* weight to be confirmed

QUN 42D	Metal	
	Matt Black ME.NER.20	
Customer's fabric mtl. 12,00	●	
Fabric cat. A	●	
Fabric cat. B	●	
Fabric cat. C	●	
Fabric cat. D	●	
Leather	●	
Leather Lux	●	

| GALLERY &gt;

| SOFAS &gt;

| FINISHES &gt;

| UPHOLSTERY &gt;

# QUINTO

 | Studio Galimberti - 2019

Chaise longue SX

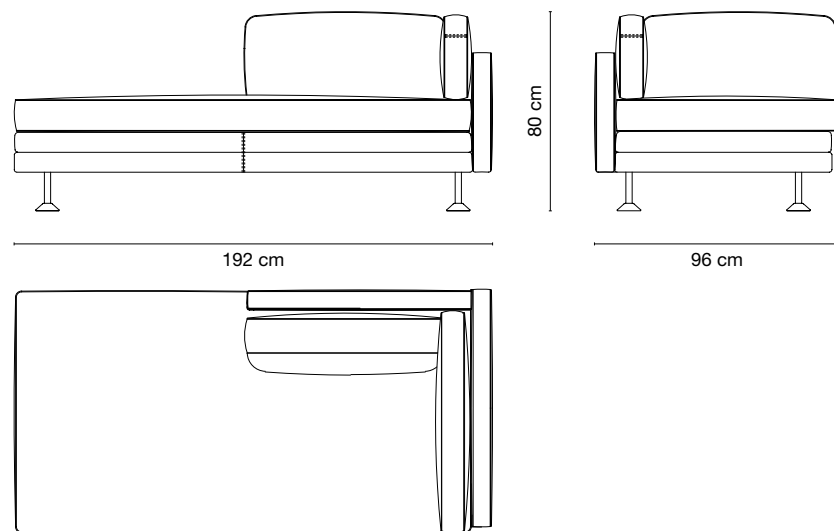
**TECHNICAL FEATURES****Structure:** solid wood and plywood panels**Seat and backrest:** padding in variable density high-resistance foam polyurethane / seat with elastic straps / non-removable cover**Cushions:** goose down divided into sections with polyurethane inset / removable cover**Legs:** painted metal**Piping:** gros grain**Protective glides:** soft non-scratch rubber

Packaging	assembled	cbm.	kg.	not assembled	cbm.	kg.
Standard	●	1,40	72	●	1,10	72
Pallet	●	1,70	*	●	1,40	*
Wooden crate	●	2,08	*	●	1,74	*

*\* weight to be confirmed*

QUN 43E	Metal	
	Matt Black ME.NER.20	
Customer's fabric mtl. 12,00	●	
Fabric cat. A	●	
Fabric cat. B	●	
Fabric cat. C	●	
Fabric cat. D	●	
Leather	●	
Leather Lux	●	



| GALLERY &gt;

| SOFAS &gt;

| FINISHES &gt;

| UPHOLSTERY &gt;



This elegant dining table, stunning in its simplicity, will bring a touch of luxurious sophistication to a classically decorated dining room, thanks to its exquisite craftsmanship and the use of precious material. Celebrating the essence of pure form, this table showcases a minimalistic top where the striking natural veins of the wood are a one-of-a-kind artistic decoration of the piece.

**Tops, structure and legs finishes:** natural walnut / honey walnut / matt and glossy tobacco walnut / moreo walnut



**RIG 19F**  
Dining table 190

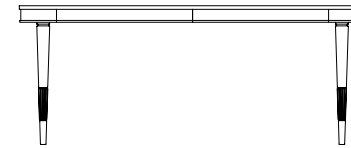

**RIG 82T**  
Extendable dining table 190





**RIG 83V**  
Dining table 240



 | [VIEW ON WEBSITE](#) >

 | [GALLERY](#) >

 | [DINING TABLES](#) >

 | [FINISHES](#) >

 | [UPHOLSTERY](#) >

Dining table 190

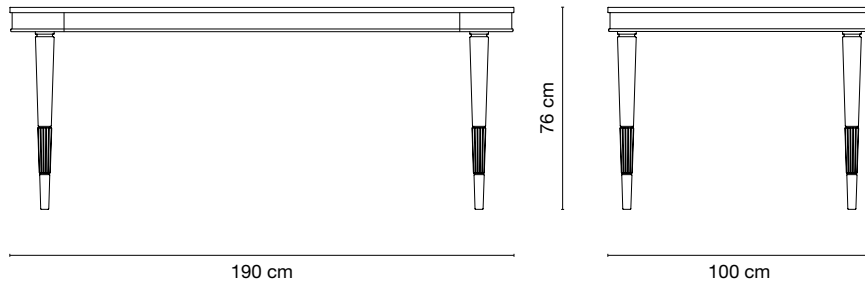

### TECHNICAL FEATURES

**Top:** chipboard panel covered with walnut wood veneer

**Undermount structure:** solid walnut and plywood panels covered with walnut wood veneer





**Legs:** solid walnut

**Protective glides:** felt

Packaging	not assembled	cbm.	kg.
Standard	•	0,32	64
Wooden crate	•	0,66	*

\* weight to be confirmed

RIG 19F	Matt walnut				Glossy walnut
	Natural Walnut NO.020.NA	Honey Walnut NO.020.MI	Tobacco Walnut NO.020.TA	Moro Walnut NO.020.MO	Tobacco Walnut NO.100.TA
	•	•	•	•	•

-  | GALLERY >
-  | DINING TABLES >
-  | FINISHES >
-  | UPHOLSTERY >

Extendable dining table 190

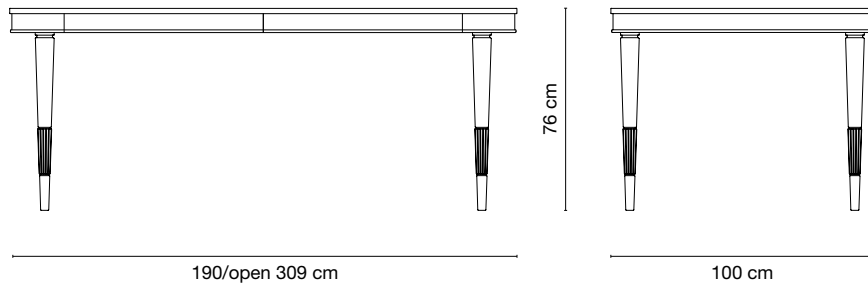

### TECHNICAL FEATURES

**Top:** chipboard panel covered with walnut wood veneer

**Undermount structure:** solid walnut and plywood panels covered with walnut wood veneer

**Legs:** solid walnut

**Extension mechanism:** aluminum sliding guides

**Extensions:** solid walnut, plywood and chipboard panels covered with walnut wood veneer / externally housed

**Protective glides:** felt

Packaging	not assembled	cbm.	kg.
Standard	•	0,50	82
Wooden crate	•	1,02	*

\* weight to be confirmed

RIG 82T	Matt walnut				Glossy walnut
	Natural Walnut NO.020.NA	Honey Walnut NO.020.MI	Tobacco Walnut NO.020.TA	Moro Walnut NO.020.MO	Tobacco Walnut NO.100.TA
	•	•	•	•	•



| GALLERY >

| DINING TABLES >

| FINISHES >

| UPHOLSTERY >

Dining table 240

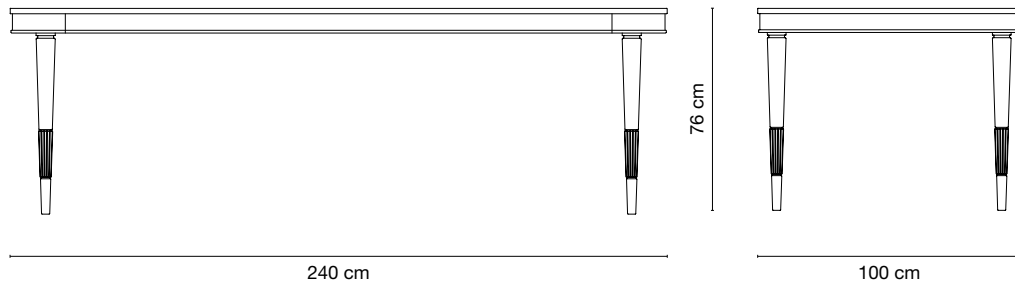

### TECHNICAL FEATURES

**Top:** chipboard panel covered with walnut wood veneer

**Undermount structure:** solid walnut and plywood panels covered with walnut wood veneer

**Legs:** solid walnut

**Protective glides:** felt

Packaging	not assembled	cbm.	kg.
Standard	•	0,40	74
Wooden crate	•	0,80	*

\* weight to be confirmed

RIG 83V	Matt walnut				Glossy walnut
	Natural Walnut NO.020.NA	Honey Walnut NO.020.MI	Tobacco Walnut NO.020.TA	Moro Walnut NO.020.MO	Tobacco Walnut NO.100.TA
	•	•	•	•	•



| GALLERY >

| DINING TABLES >

| FINISHES >

| UPHOLSTERY >



Inviting and sophisticated armchair and ottoman with a visual aesthetic will bring the vitality to a classic living room or a private study. The pieces with a strong personality but at the same time able to donate a comfortable seat to dedicate some moments of the day to complete relaxation.

**Covers:** fabric / leather

**Structure finishes:** white ash wood / tobacco ash wood / moro ash wood / ebonized ash wood

**Studs finish:** patinated gold

 | [VIEW ON WEBSITE](#) >

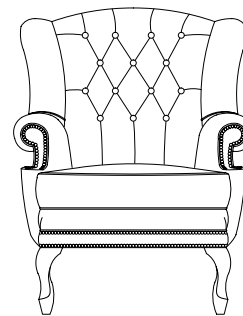

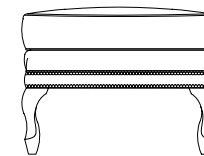

**SIN 01A**  
Armchair >



**SIN 03C**  
Ottoman >

 | [GALLERY](#) >

 | [ARMCHAIRS AND OTTOMANS](#) >

 | [FINISHES](#) >

 | [UPHOLSTERY](#) >



# SINATRA

 | Studio Galimberti - 2009

Armchair

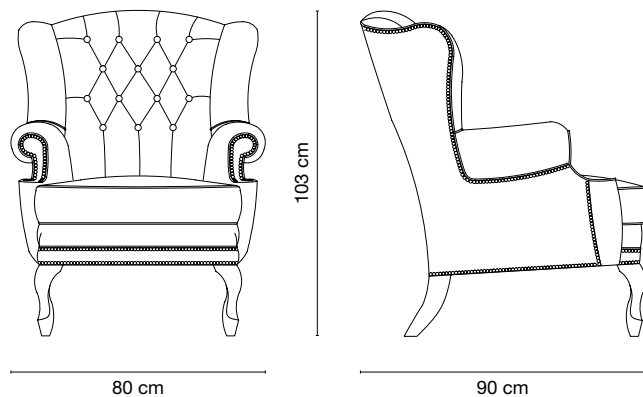
**TECHNICAL FEATURES****Structure:** solid wood**Seat and backrest:** padding in variable density high-resistance foam polyurethane / seat with elastic straps / non-removable cover**Cushion:** goose down divided into sections with high-resistance foam polyurethane inset and polyester fiber lining / removable cover**Legs:** solid ash wood**Studs:** metal**Protective glides:** felt

Packaging	assembled	cbm.	kg.
Standard	●	0,96	30
Pallet	●	1,08	*
Wooden crate	●	1,40	*

\* weight to be confirmed

SIN 01A	Ash wood			
	White FR.020.BI	Tobacco FR.020.TA	Moro FR.020.MO	Ebonized FR.020.EB
Customer's fabric mtl. 5,50	●	●	●	●
Fabric cat. A	●	●	●	●
Fabric cat. B	●	●	●	●
Fabric cat. C	●	●	●	●
Fabric cat. D	●	●	●	●
Leather	●	●	●	●
Leather Lux	●	●	●	●



| GALLERY &gt;

| ARMCHAIRS AND OTTOMANS &gt;

| FINISHES &gt;

| UPHOLSTERY &gt;

## Ottoman

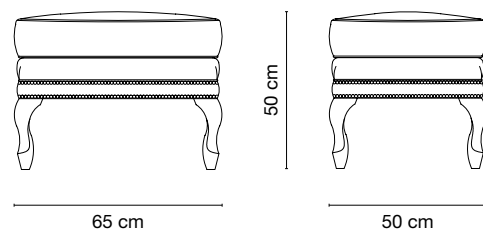
**TECHNICAL FEATURES****Structure:** solid wood**Seat:** padding in variable density high-resistance foam polyurethane / seat with elastic straps / non-removable cover**Cushion:** goose down divided into sections with high-resistance foam polyurethane inset and polyester fiber lining / removable cover**Legs:** solid ash wood**Studs:** metal**Protective glides:** felt

Packaging	assembled	cbm.	kg.
Standard	●	0,22	12
Wooden crate	●	0,40	*

\* weight to be confirmed

SIN 03C	Ash wood			
	White FR.020.BI	Tobacco FR.020.TA	Moro FR.020.MO	Ebonized FR.020.EB
Customer's fabric mtl. 2,30	●	●	●	●
Fabric cat. A	●	●	●	●
Fabric cat. B	●	●	●	●
Fabric cat. C	●	●	●	●
Fabric cat. D	●	●	●	●
Leather	●	●	●	●
Leather Lux	●	●	●	●

[GALLERY](#)
[ARMCHAIRS AND OTTOMANS](#)
[FINISHES](#)
[UPHOLSTERY](#)

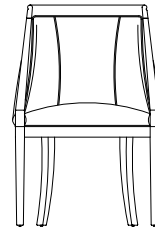

**SOP 11A**  
Dining arm chair

Showing a classic design with a modern and elegant touch, this superb dining arm chair will complement contemporary and traditional dining rooms. The elegant shape of the structure, the backrest and the armrests with sinuous curved lines donate a visually attractive look to the seat and guarantee the perfect comfort.

**Covers:** fabric / leather

**Structure finishes:** matt and glossy lacquer in the Galimberti Nino colour range / white ash wood / tobacco ash wood / moro ash wood / ebonized ash wood

 | [VIEW ON WEBSITE](#) >

 | [GALLERY](#) >

 | [CHAIRS](#) >

 | [FINISHES](#) >

 | [UPHOLSTERY](#) >

# SOPHIA

 | Studio Galimberti - 2009

Dining arm chair

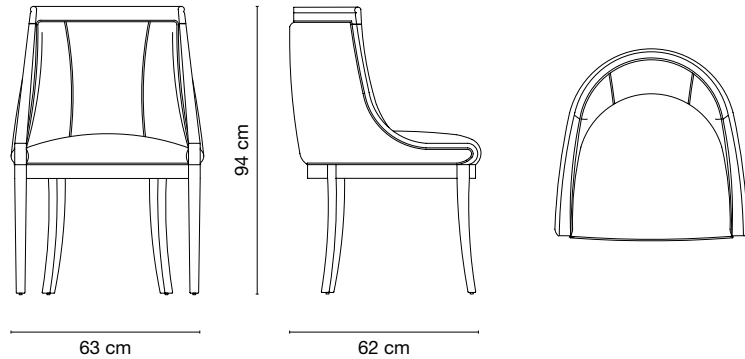
**TECHNICAL FEATURES****Structure:** solid beech wood / solid ash wood**Seat and backrest:** padding in variable density high-resistance foam polyurethane / seat with elastic straps / non-removable cover**Piping:** gros grain**Protective glides:** felt

Packaging	assembled	cbm.	kg.
Standard	●	0,40	15
Pallet	●	0,46	*
Wooden crate	●	0,64	*

\* weight to be confirmed

SOP 11A	Matt lacquered				Glossy lacquered				Ash wood			
	M001 M002 M003 M004 M005 M014	M006 M007 M011 M012 M013 M015 M018 M019	G001 G002 G003 G004 G005 G014	G006 G007 G011 G012 G013 G015 G018 G019	White FR.020.BI	Tobacco FR.020.TA	Moro FR.020.MO	Ebonized FR.020.EB				
Customer's fabric mtl. 2,00	●	●	●	●	●	●	●	●				
Fabric cat. A	●	●	●	●	●	●	●	●				
Fabric cat. B	●	●	●	●	●	●	●	●				
Fabric cat. C	●	●	●	●	●	●	●	●				
Fabric cat. D	●	●	●	●	●	●	●	●				
Leather	●	●	●	●	●	●	●	●				
Leather Lux	●	●	●	●	●	●	●	●				

| GALLERY &gt;

| CHAIRS &gt;

| FINISHES &gt;

| UPHOLSTERY &gt;



The simple lines, the minimal aesthetic and functional design enriched with unique and refined details define these exquisite night storages that will adorn any bedroom with their clean sophistication. Evoking the elegance of classic 1960s furniture this simple yet chic design will elevate the style of any interior.

**Top and structure finishes:** matt and glossy lacquer in the Galimberti Nino colour range  
**Legs ferrules and Diva handles finishes:** bronze painted / satin brass

 | [VIEW ON WEBSITE](#) >

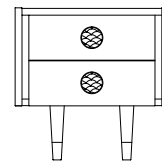

**STI 42B**  
Night table >

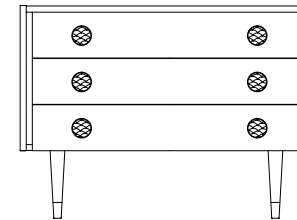



**STI 31A**  
Chest of drawers >



 | [GALLERY](#) >

 | [NIGHT STORAGES](#) >

 | [FINISHES](#) >

 | [UPHOLSTERY](#) >

## Night table

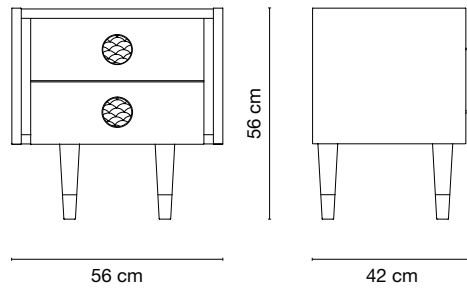
**TECHNICAL FEATURES**

**Top, structure and drawers' frontal:** MDF and chipboard panels

**Drawers' structure:** birch plywood / drawers runners with Blumotion technology

**Legs:** toulipier solid wood

**Legs ferrules:** brass

**Diva handles:** brass with white selected buffalo's horn inset

**Protective glides:** felt

Packaging	assembled	cbm.	kg.	not assembled	cbm.	kg.
Standard	●	0,18	30	0 €	0,12	30
Pallet	●	0,22	*	55 €	0,18	*
Wooden crate	●	0,34	*	160 €	0,26	*

\* weight to be confirmed

STI 42B	Matt lacquered				Glossy lacquered			
	M001 M002 M003 M004 M005 M014	M006 M007 M011 M012 M013 M015 M018 M019	G001 G002 G003 G004 G005 G014	G006 G007 G011 G012 G013 G015 G018 G019				
	●	●	●	●				



| GALLERY >

| NIGHT STORAGES >

| FINISHES >

| UPHOLSTERY >

## Chest of drawers

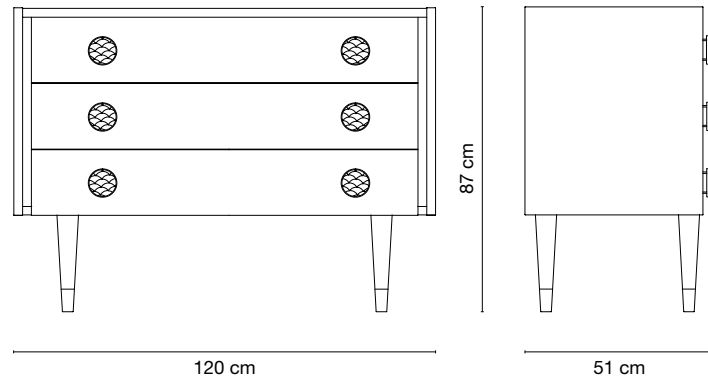
**TECHNICAL FEATURES**

**Top, structure and drawers' frontal:** MDF and chipboard panels

**Drawers' structure:** birch plywood / drawers runners with Blumotion technology

**Legs:** toulipier solid wood

**Legs ferrules:** brass

**Diva handles:** brass with white selected buffalo's horn inset

**Protective glides:** felt

Packaging	assembled	cbm.	kg.	not assembled	cbm.	kg.
Standard	●	0,72	86	0 €	0,54	86
Pallet	●	0,84	*	85 €	0,64	*
Wooden crate	●	1,10	*	255 €	0,86	*

\* weight to be confirmed

STI 31A	Matt lacquered				Glossy lacquered			
	M001 M002 M003 M004 M005 M014	M006 M007 M011 M012 M013 M015 M018 M019	G001 G002 G003 G004 G005 G014	G006 G007 G011 G012 G013 G015 G018 G019				
	●	●	●	●				



| GALLERY >

| NIGHT STORAGES >

| FINISHES >

| UPHOLSTERY >



Striking and unique, the playful design of this side table is also its very functional aspect, which allows it to come close to a bed, sofa or armchair becoming a perfect companion for relaxing times spent reading a book or lounging with a drink.

**Tops finishes:** natural walnut / honey walnut / matt and glossy tobacco walnut / more walnut

**Structure finishes:** leather in the Galimberti Nino colour range

 | [VIEW ON WEBSITE](#) >

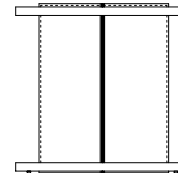

**TAL 01A**  
Side table >

 | [GALLERY](#) >

 | [COFFEE AND SIDE TABLES](#) >

 | [FINISHES](#) >

 | [UPHOLSTERY](#) >



Side table

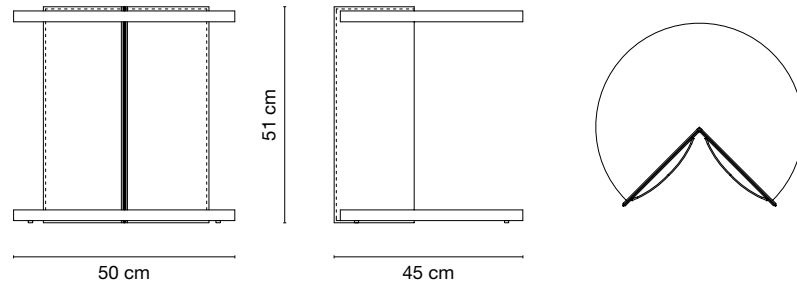

### TECHNICAL FEATURES

**Tops:** chipboard panels covered with walnut wood veneer

**Structure:** metal covered with leather with visible stitching

**Protective glides:** felt

Packaging	assembled	cbm.	kg.
Standard	•	0,20	15
Wooden crate	•	0,34	*

\* weight to be confirmed

TAL 01A	Matt walnut				Glossy walnut
	Natural Walnut NO.020.NA	Honey Walnut NO.020.MI	Tobacco Walnut NO.020.TA	Moro Walnut NO.020.MO	Tobacco Walnut NO.100.TA
Leather	•	•	•	•	•
Leather Lux	•	•	•	•	•

| GALLERY >

| COFFEE AND SIDE TABLES >

| FINISHES >

| UPHOLSTERY >

## THEA | Ilenia Viscardi - 2004



A versatile seating option that is modern and sophisticated, this club chair exudes industrial allure and will be a stunning addition to a modern living room, study or bedroom. Its sinuous structure in metal supports a seat and back covered in leather with visible stitches for a striking contrast.

**Structure covers:** leather

 | [VIEW ON WEBSITE](#) >

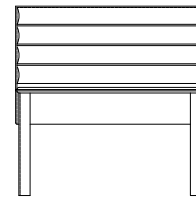



**THE 31C**  
Club chair >



 | [GALLERY](#) >

 | [ARMCHAIRS AND OTTOMANS](#) >

 | [FINISHES](#) >

 | [UPHOLSTERY](#) >

## THEA | Ilenia Viscardi - 2004

Club chair

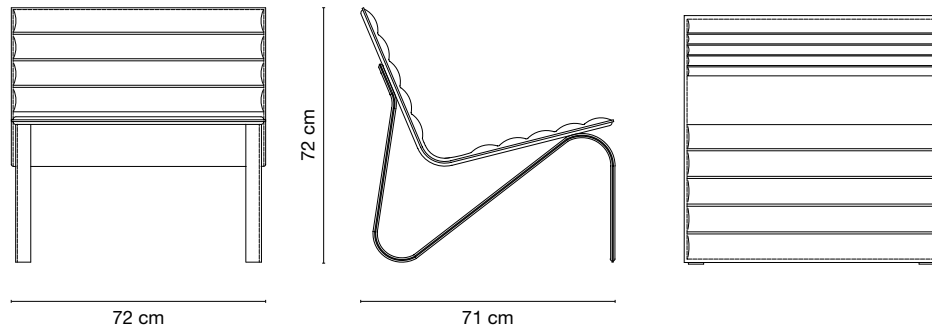

### TECHNICAL FEATURES

**Seat and backrest:** plywood panels / padding in variable density high-resistance foam polyurethane / non-removable cover

**Basement:** leather covered metal

Packaging	assembled	cbm.	kg.
Standard	●	0,48	20
Pallet	●	0,58	*
Wooden crate	●	0,78	*

\* weight to be confirmed

THE 31C		
Leather	●	
Leather Lux	●	



| GALLERY >

| ARMCHAIRS AND OTTOMANS >

| FINISHES >

| UPHOLSTERY >

# THEA SOFT | Ilenia Viscardi - 2004

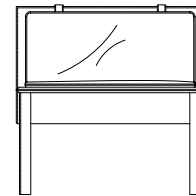



**THE 32D**  
Club chair

A versatile seating option that is modern and sophisticated, this club chair exudes industrial allure and will be a stunning addition to a modern living room, study or bedroom. Its sinuous structure in metal supports a seat and back covered in leather with visible stitches for a striking contrast.

**Structure covers:** leather  
**Cushion covers:** fabric / leather

 | [VIEW ON WEBSITE](#) >

 | [GALLERY](#) >

 | [ARMCHAIRS AND OTTOMANS](#) >

 | [FINISHES](#) >

 | [UPHOLSTERY](#) >

# THEA SOFT

 | Ilenia Viscardi - 2004

Club chair

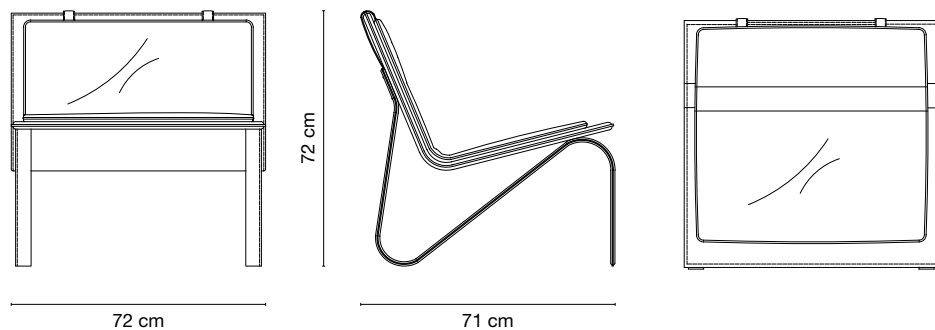
**TECHNICAL FEATURES**

**Seat and backrest:** plywood panels / padding in variable density high-resistance foam polyurethane / non-removable cover

**Cushion:** foam polyurethane padding

**Basement:** leather covered metal

Packaging	assembled	cbm.	kg.
Standard	●	0,48	22
Pallet	●	0,58	*
Wooden crate	●	0,78	*

\* weight to be confirmed

THE 32D		
	Leather	Leather Lux
Customer's fabric mtl. 1,20	●	●
Fabric cat. A	●	●
Fabric cat. B	●	●
Fabric cat. C	●	●
Fabric cat. D	●	●
Leather	●	●
Leather Lux	●	●



| GALLERY &gt;

| ARMCHAIRS AND OTTOMANS &gt;

| FINISHES &gt;

| UPHOLSTERY &gt;



Theo dining table will stand out with its elegant and soft lines both in a modern and contemporary environment, where it will be an important presence thanks to the harmonious combination of the linearity of the top with the expressive solidity of the bases.

**Top and structure finishes:** matt lacquer and glossy lacquer colours in the Galimberti Nino colour range

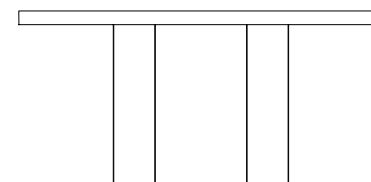



**TEO 16R**  
Dining table



 | GALLERY >

 | DINING TABLES >

 | FINISHES >

 | UPHOLSTERY >

Dining table

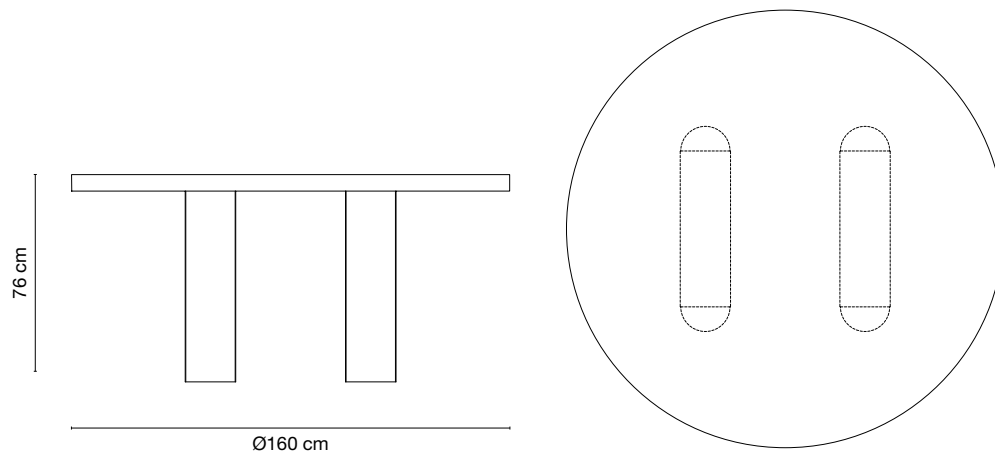

### TECHNICAL FEATURES

**Top:** honeycomb MDF panel

**Undermount structure:** painted metal

**Bases:** MDF panels

**Protective glides:** felt

Packaging	not assembled	cbm.	kg.
Standard	•	0,74	106
Pallet**	•	0,86	*
Wooden crate	•	1,38	*

\* weight to be confirmed \*\* top not included

TEO 16R	Matt lacquered				Glossy lacquered			
	M001 M002 M003 M004 M005 M014	M006 M007 M011 M012 M013 M015 M018 M019	G001 G002 G003 G004 G005 G014	G006 G007 G011 G012 G013 G015 G018 G019				
	•	•	•	•				



| GALLERY >

| DINING TABLES >

| FINISHES >

| UPHOLSTERY >

**TIFFANY** | Studio Galimberti - 1994



The Tiffany console is the quintessence of the decorative element that is expressed in conferring an unusual and timeless prestige and dynamism to any interiors, be it classic or contemporary. A romantic idea, a reminiscence of classicism, it expresses in its being the craftsmanship, the mastery of the art of cabinetry and the great attention to the detail of the high-manufactured furniture piece.

**Top and structure finishes:** natural walnut / honey walnut / tobacco walnut / moro walnut  
**Gioiello handles finishes:** silver

 | [VIEW ON WEBSITE](#) >

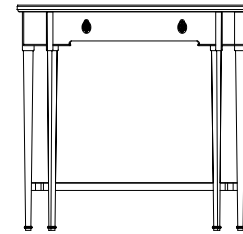



**TFY 01E**  
Console >



 | [GALLERY](#) >

 | [CONSOLES](#) >

 | [FINISHES](#) >

 | [UPHOLSTERY](#) >



Console

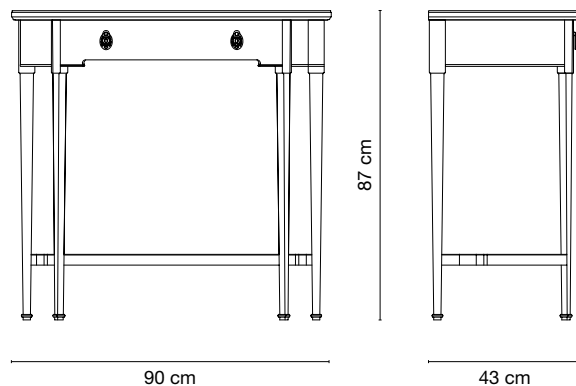

### TECHNICAL FEATURES

**Top:** solid walnut frame and chipboard panel covered with walnut veneer  
**Structure and drawers' frontal:** walnut solid wood, toulipier solid wood and plywood covered with walnut veneer  
**Drawers' structure:** walnut solid wood and MDF panel covered with walnut veneer / drawers runners in solid beech wood  
**Legs:** walnut solid wood  
**Gioiello handles:** metal alloy  
**Protective glides:** felt

Packaging	not assembled	cbm.	kg.
Standard	●	0,40	21
Pallet	●	0,46	*
Wooden crate	●	0,64	*

\* weight to be confirmed

TFY 01E	Matt walnut			
	Natural Walnut NO.020.NA	Honey Walnut NO.020.MI	Tobacco Walnut NO.020.TA	Moro Walnut NO.020.MO
	●	●	●	●

- | GALLERY >
- | CONSOLES >
- | FINISHES >
- | UPHOLSTERY >

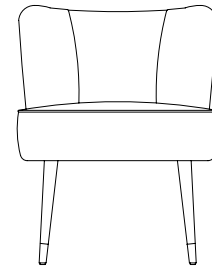

**TIS 41D**  
Chair >

Tissi chair is an elegant and comfortable piece distinctive for its soft rounded silhouette that seems to float in midair supported by four thin legs decorated with brass ferrules. This item will be decorative and functional for any kind of environment, as around a dining table, as in front of a desk.

**Covers:** fabric

**Legs finishes:** matt lacquer and glossy lacquer colours in the Galimberti Nino colour range / natural walnut / honey walnut / matt and glossy tobacco walnut / moro walnut

**Legs ferrules:** bronze painted / satin brass

 | GALLERY >

 | CHAIRS >

 | FINISHES >

 | UPHOLSTERY >

## Dining chair

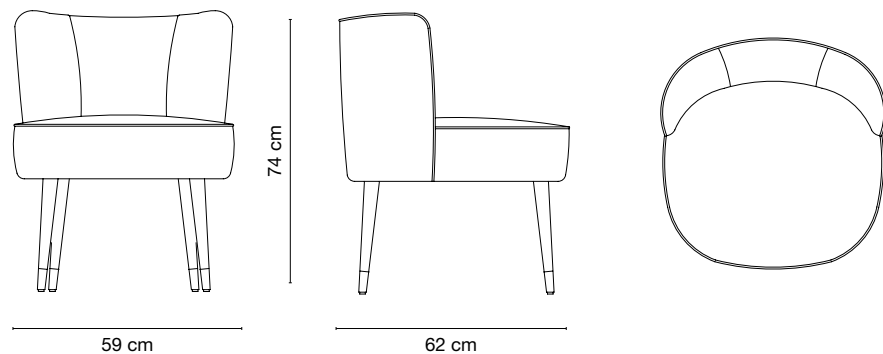
**TECHNICAL FEATURES**

**Seat and backrest:** solid wood and plywood panels / padding in variable density high-resistance foam polyurethane / non-removable cover

**Legs:** solid beech wood / solid walnut

**Legs ferrules:** brass

**Protective glides:** felt

Packaging	assembled	cbm.	kg.	not assembled	cbm.	kg.
Standard	●	0,32	16	●	0,20	16
Pallet	●	0,36	*			
Wooden crate	●	0,52	*			

\* weight to be confirmed

TIS 41D	Matt lacquered				Glossy lacquered				Matt walnut				Glossy walnut
	M001 M002 M003 M004 M005 M014	M006 M007 M011 M012 M013 M015 M018 M019	G001 G002 G003 G004 G005 G014	G006 G007 G011 G012 G013 G015 G018 G019	Natural Walnut NO.020.NA	Honey Walnut NO.020.MI	Tobacco Walnut NO.020.TA	Moro Walnut NO.020.MO	Tobacco Walnut NO.100.TA				
Customer's fabric mtl. 1,80	●	●	●	●	●	●	●	●	●				
fabric cat. A	●	●	●	●	●	●	●	●	●				
fabric cat. B	●	●	●	●	●	●	●	●	●				
fabric cat. C	●	●	●	●	●	●	●	●	●				
fabric cat. D	●	●	●	●	●	●	●	●	●				

| GALLERY >

| CHAIRS >

| FINISHES >

| UPHOLSTERY >

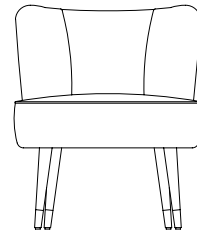

**TIS 55A**  
Lounge chair

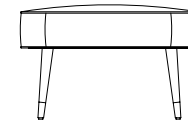

**TIS 73C**  
Small bench

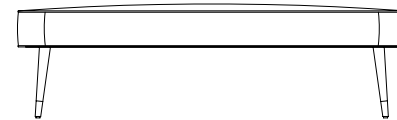

**TIS 62B**  
Bench



Tissi lounge chair and benches are elegant and comfortable pieces, distinctive for their soft rounded silhouette that seem to float in midair supported by four thin legs decorated with brass ferrules. These items will be decorative and functional for any kind of environment, in the bedroom, entrance hall or living room.

**Covers:** fabric

**Legs finishes:** matt and glossy lacquer in the Galimberti Nino colour range / natural walnut / honey walnut / matt and glossy tobacco walnut / moro walnut

**Legs ferrules:** bronze painted / satin brass

 | [VIEW ON WEBSITE](#)



 | [GALLERY](#)



 | [ARMCHAIRS  
AND OTTOMANS](#)



 | [FINISHES](#)



 | [UPHOLSTERY](#)

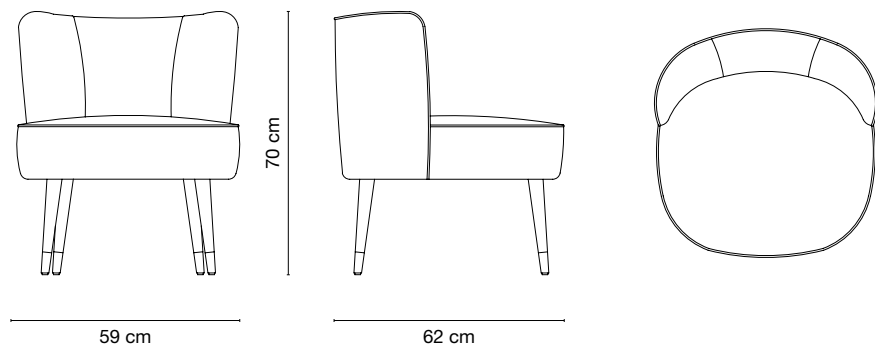

## Lounge chair

**TECHNICAL FEATURES**

**Seat and backrest:** solid wood and plywood panels / padding in variable density high-resistance foam polyurethane / non-removable cover

**Legs:** solid beech wood / solid walnut

**Legs ferrules:** brass

**Protective glides:** felt

Packaging	assembled	cbm.	kg.	not assembled	cbm.	kg.
Standard	●	0,30	15	●	0,20	15
Pallet	●	0,36	*			
Wooden crate	●	0,50	*			

\* weight to be confirmed

TIS 55A	Matt lacquered				Glossy lacquered				Matt walnut				Glossy walnut
	M001 M002 M003 M004 M005 M014	M006 M007 M011 M012 M013 M015 M018 M019	G001 G002 G003 G004 G005 G014	G006 G007 G011 G012 G013 G015 G018 G019	Natural Walnut NO.020.NA	Honey Walnut NO.020.MI	Tobacco Walnut NO.020.TA	Moro Walnut NO.020.MO	Tobacco Walnut NO.100.TA				
Customer's fabric mtl. 1,80	●	●	●	●	●	●	●	●	●				
Fabric cat. A	●	●	●	●	●	●	●	●	●				
Fabric cat. B	●	●	●	●	●	●	●	●	●				
Fabric cat. C	●	●	●	●	●	●	●	●	●				
Fabric cat. D	●	●	●	●	●	●	●	●	●				

| GALLERY >

| ARMCHAIRS AND OTTOMANS >

| FINISHES >

| UPHOLSTERY >

Small bench

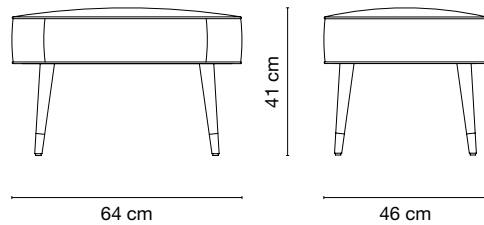
**TECHNICAL FEATURES**

**Seat:** plywood panel / padding in variable density high-resistance foam polyurethane / non-removable cover

**Legs:** solid beech wood / solid walnut

**Legs ferrules:** brass

**Protective glides:** felt

Packaging	assembled	cbm.	kg.	not assembled	cbm.	kg.
Standard	●	0,16	8	●	0,08	8
Pallet	●	0,20	*			
Wooden crate	●	0,30	*			

\* weight to be confirmed

TIS 73C	Matt lacquered				Glossy lacquered				Matt walnut				Glossy walnut						
	M001 M004	M002 M005	M003 M014	M006 M013	M007 M015	M011 M018	M012 M019	G001 G004	G002 G005	G003 G014	G006 G013	G007 G015	G011 G018	G012 G019	Natural Walnut NO.020.NA	Honey Walnut NO.020.MI	Tobacco Walnut NO.020.TA	Moro Walnut NO.020.MO	Tobacco Walnut NO.100.TA
Customer's fabric mtl. 0,80	●			●				●			●			●			●		●
Fabric cat. A	●			●				●			●			●			●		●
Fabric cat. B	●			●				●			●			●			●		●
Fabric cat. C	●			●				●			●			●			●		●
Fabric cat. D	●			●				●			●			●			●		●

| GALLERY &gt;

| ARMCHAIRS AND OTTOMANS &gt;

| FINISHES &gt;

| UPHOLSTERY &gt;

## Bench

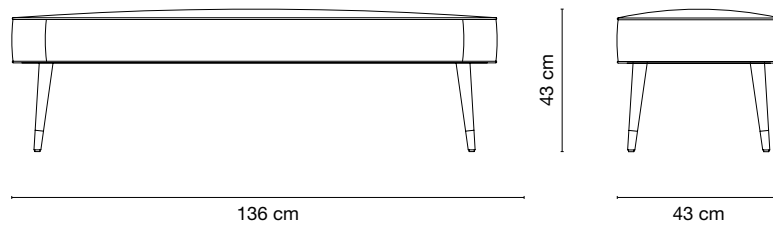
**TECHNICAL FEATURES**

**Seat:** plywood panel / padding in variable density high-resistance foam polyurethane / non-removable cover

**Legs:** solid beech wood / solid walnut

**Legs ferrules:** brass

**Protective glides:** felt

Packaging	assembled	cbm.	kg.	not assembled	cbm.	kg.
Standard	●	0,34	17	●	0,16	17
Pallet	●	0,44	*			
Wooden crate	●	0,62	*			

\* weight to be confirmed

TIS 62B	Matt lacquered				Glossy lacquered				Matt walnut				Glossy walnut						
	M001 M004	M002 M005	M003 M014	M006 M013	M007 M015	M011 M018	M012 M019	G001 G004	G002 G005	G003 G014	G006 G013	G007 G015	G011 G018	G012 G019	Natural Walnut NO.020.NA	Honey Walnut NO.020.MI	Tobacco Walnut NO.020.TA	Moro Walnut NO.020.MO	Tobacco Walnut NO.100.TA
Customer's fabric mtl. 1,30	●			●				●			●			●	●	●	●	●	●
Fabric cat. A	●			●				●			●			●	●	●	●	●	●
Fabric cat. B	●			●				●			●			●	●	●	●	●	●
Fabric cat. C	●			●				●			●			●	●	●	●	●	●
Fabric cat. D	●			●				●			●			●	●	●	●	●	●

| GALLERY >

| ARMCHAIRS AND OTTOMANS >

| FINISHES >

| UPHOLSTERY >



Sensual, curvy, mischievous. Tissi bed manages to be proactive and audacious thanks to its rounded and inviting shapes. Its important dimensions and its lines that constantly change direction, make it a unique and gritty piece. Tissi bed, while appearing strong and alter, dominates the scene with lightness and elegance. It adapts to every kind of environment, from classic to contemporary.

**Covers:** fabric

**Base finishes:** matt and glossy lacquer in the Galimberti Nino colour range / natural walnut / honey walnut / matt and glossy tobacco walnut / moro walnut

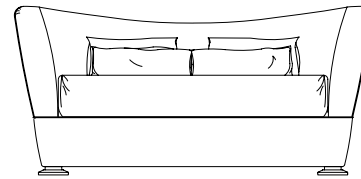

**TIS 06F**  
Bed 160

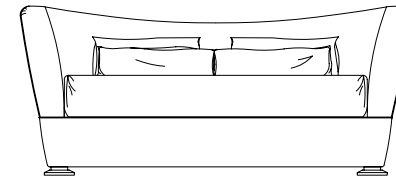

**TIS 18B**  
Bed 180

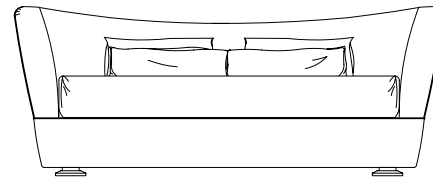

**TIS 20H**  
Bed 200



VIEW ON WEBSITE



GALLERY



BEDS



FINISHES



UPHOLSTERY



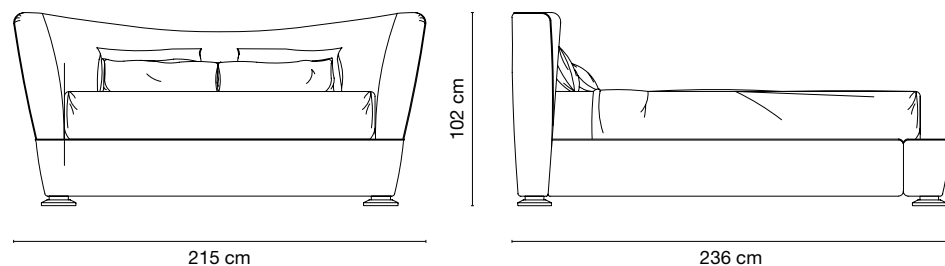

## Bed 160

**TECHNICAL FEATURES****Structure:** solid wood and plywood panels**Legs:** MDF panel / solid walnut wood**Headboard, footboard and sides:** padding in variable density high-resistance foam polyurethane / non-removable cover**Piping:** gros grain**Mattress' support:** metal bed frame with wooden slats**Protective glides:** felt**Mattress (not included):** size 160 x 200 x h.22 cm

Cushions and bed set not included

Packaging	not assembled	cbm.	kg.
Standard	●	1,64	138
Wooden crate**	●	2,50	*

\* weight to be confirmed \*\* slatted base not included

TIS 06F	Matt lacquered				Glossy lacquered				Matt walnut				Glossy walnut
	M001 M002 M003 M004 M005 M014	M006 M007 M011 M012 M013 M015 M018 M019	G001 G002 G003 G004 G005 G014	G006 G007 G011 G012 G013 G015 G018 G019	Natural Walnut NO.020.NA	Honey Walnut NO.020.MI	Tobacco Walnut NO.020.TA	Moro Walnut NO.020.MO	Tobacco Walnut NO.100.TA				
Customer's fabric mtl. 9,00	●	●	●	●	●	●	●	●	●				
Fabric cat. A	●	●	●	●	●	●	●	●	●				
Fabric cat. B	●	●	●	●	●	●	●	●	●				
Fabric cat. C	●	●	●	●	●	●	●	●	●				
Fabric cat. D	●	●	●	●	●	●	●	●	●				

| GALLERY &gt;

| BEDS &gt;

| FINISHES &gt;

| UPHOLSTERY &gt;

## Bed 180

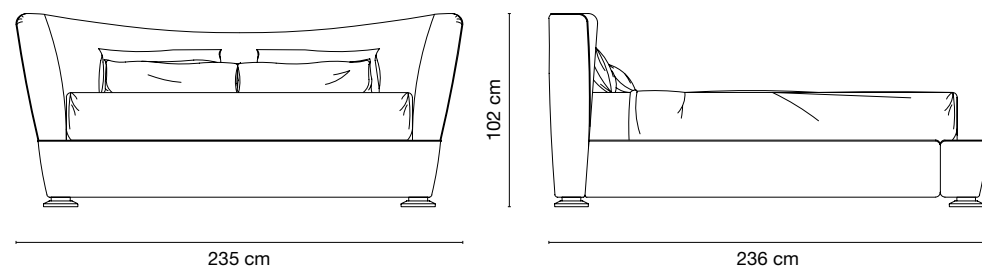
**TECHNICAL FEATURES****Structure:** solid wood and plywood panels**Legs:** MDF panel / solid walnut wood**Headboard, footboard and sides:** padding in variable density high-resistance foam polyurethane / non-removable cover**Piping:** gros grain**Mattress' support:** metal bed frame with wooden slats**Protective glides:** felt**Mattress (not included):** size 180 x 200 x h.22 cm

Cushions and bed set not included

Packaging	not assembled	cbm.	kg.
Standard	●	1,80	147
Wooden crate**	●	2,74	*

\* weight to be confirmed \*\* slatted base not included

TIS 18B	Matt lacquered				Glossy lacquered				Matt walnut				Glossy walnut
	M001 M002 M003 M004 M005 M014	M006 M007 M011 M012 M013 M015 M018 M019	G001 G002 G003 G004 G005 G014	G006 G007 G011 G012 G013 G015 G018 G019	Natural Walnut NO.020.NA	Honey Walnut NO.020.MI	Tobacco Walnut NO.020.TA	Moro Walnut NO.020.MO	Tobacco Walnut NO.100.TA				
Customer's fabric mtl. 10,00	●	●	●	●	●	●	●	●	●				
Fabric cat. A	●	●	●	●	●	●	●	●	●				
Fabric cat. B	●	●	●	●	●	●	●	●	●				
Fabric cat. C	●	●	●	●	●	●	●	●	●				
Fabric cat. D	●	●	●	●	●	●	●	●	●				

| GALLERY &gt;

| BEDS &gt;

| FINISHES &gt;

| UPHOLSTERY &gt;

## Bed 200

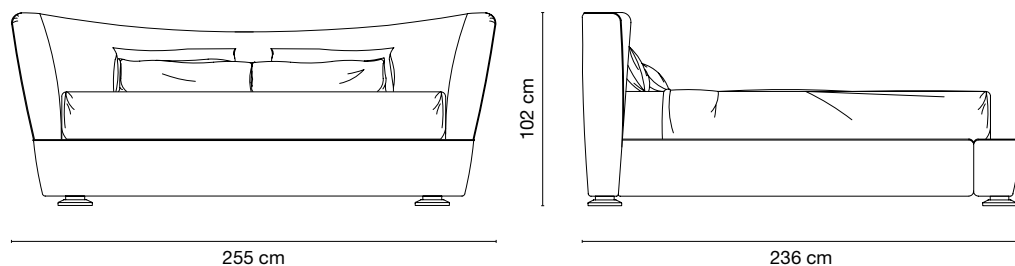
**TECHNICAL FEATURES****Structure:** solid wood and plywood panels**Legs:** MDF panel / solid walnut wood**Headboard, footboard and sides:** padding in variable density high-resistance foam polyurethane / non-removable cover**Piping:** gros grain**Mattress' support:** metal bed frame with wooden slats**Protective glides:** felt**Mattress (not included):** size 200 x 200 x h.22 cm

Cushions and bed set not included

Packaging	not assembled	cbm.	kg.
Standard	●	1,94	162
Wooden crate**	●	2,94	*

\* weight to be confirmed \*\* slatted base not included

TIS 20H	Matt lacquered				Glossy lacquered				Matt walnut				Glossy walnut
	M001 M002 M003 M004 M005 M014	M006 M007 M011 M012 M013 M015 M018 M019	G001 G002 G003 G004 G005 G014	G006 G007 G011 G012 G013 G015 G018 G019	Natural Walnut NO.020.NA	Honey Walnut NO.020.MI	Tobacco Walnut NO.020.TA	Moro Walnut NO.020.MO	Tobacco Walnut NO.100.TA				
Customer's fabric mtl. 11,00	●	●	●	●	●	●	●	●	●				
Fabric cat. A	●	●	●	●	●	●	●	●	●				
Fabric cat. B	●	●	●	●	●	●	●	●	●				
Fabric cat. C	●	●	●	●	●	●	●	●	●				
Fabric cat. D	●	●	●	●	●	●	●	●	●				

| GALLERY &gt;

| BEDS &gt;

| FINISHES &gt;

| UPHOLSTERY &gt;



The sculptural shapes combined with the light and aerial appearance give the unique perfection of the proportions to the Tomo table despite its decidedly important dimensions. A personality that is not limited to any style allows it to be combined with every type of chair, from the most classic to the most modern. Its nature does not allow to be locked up in any stylistic category except the one called work of art.

**Top and structure finishes:** natural walnut / honey walnut / matt and glossy tobacco walnut / moro walnut

**Metal finishes:** bronze painted / satin brass

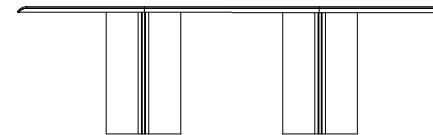

**TOM 24A**  
Dining table 240



**TOM 32C**  
Dining table 300 2 bases



 | [VIEW ON WEBSITE](#) >

 | [GALLERY](#) >

 | [DINING TABLES](#) >

 | [FINISHES](#) >

 | [UPHOLSTERY](#) >

TOMO | Ilenia Viscardi - 2020

Dining table 240

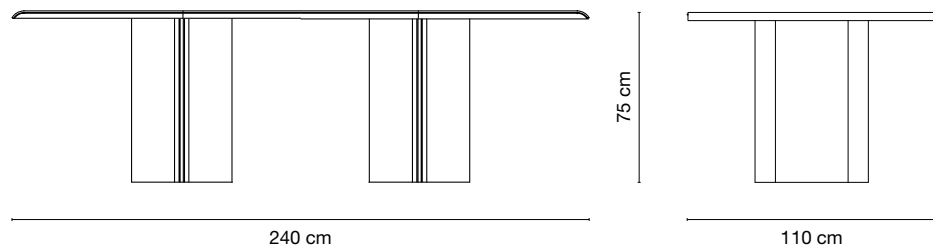
**TECHNICAL FEATURES****Top:** solid walnut and honeycomb MDF panel covered with walnut wood veneer**Undermount structure:** painted metal**Bases:** MDF and chipboard panels covered with walnut wood veneer**Metal insets:** brass**Protective glides:** felt

Packaging	not assembled	cbm.	kg.
Standard	●	0,74	150
Pallet**	●	0,88	*
Wooden crate	●	1,50	*

*\* weight to be confirmed \*\* top not included*

TOM 24A	Matt walnut				Glossy walnut
	Natural Walnut NO.020.NA	Honey Walnut NO.020.MI	Tobacco Walnut NO.020.TA	Moro Walnut NO.020.MO	Tobacco Walnut NO.100.TA
	●	●	●	●	●

| GALLERY &gt;

| DINING TABLES &gt;

| FINISHES &gt;

| UPHOLSTERY &gt;

TOMO | Ilenia Viscardi - 2020

Dining table 300 2 bases

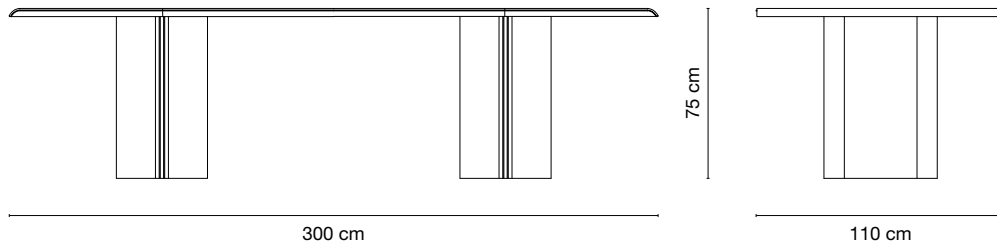
**TECHNICAL FEATURES****Top:** solid walnut and honeycomb MDF panel covered with walnut wood veneer**Undermount structure:** painted metal**Bases:** MDF and chipboard panels covered with walnut wood veneer**Metal insets:** brass**Protective glides:** felt

Packaging	not assembled	cbm.	kg.
Standard	●	0,80	154
Pallet**	●	0,96	*
Wooden crate	●	1,66	*

\* weight to be confirmed \*\* top not included

TOM 32C	Matt walnut				Glossy walnut
	Natural Walnut NO.020.NA	Honey Walnut NO.020.MI	Tobacco Walnut NO.020.TA	Moro Walnut NO.020.MO	Tobacco Walnut NO.100.TA
	●	●	●	●	●

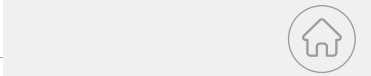

| GALLERY &gt;

| DINING TABLES &gt;

| FINISHES &gt;

| UPHOLSTERY &gt;

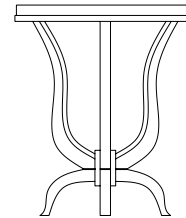

**TUL 21A**  
Side table



Evoking the elegance of classic furniture, this side table with its simple and joyful design will enrich with the style any ambience. Crafted with utmost attention to details, this versatile item reminds with its look the shape of the tulip flower.

**Top and structure finishes:** matt and glossy lacquer in the Galimberti Nino colour range

 | [VIEW ON WEBSITE](#)



[GALLERY](#)



[COFFEE AND  
SIDE TABLES](#)



[FINISHES](#)



[UPHOLSTERY](#)



## TULIPANO | Studio Galimberti - 2015

Side table

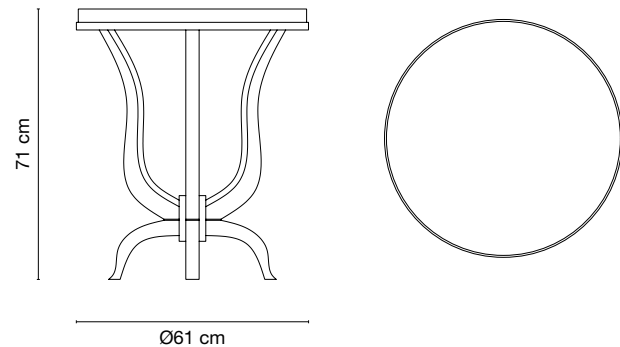

### TECHNICAL FEATURES

**Top:** MDF panels

**Structure:** toulipier massive wood

**Protective glides:** felt

Packaging	assembled	cbm.	kg.
Standard	●	0,40	18
Pallet	●	0,48	*
Wooden crate	●	0,64	*

\* weight to be confirmed

TUL 21A	Matt lacquered				Glossy lacquered			
	M001 M002 M003 M004 M005 M014	M006 M007 M011 M012 M013 M015 M018 M019	G001 G002 G003 G004 G005 G014	G006 G007 G011 G012 G013 G015 G018 G019				
	●	●	●	●				



| GALLERY >

| COFFEE AND SIDE TABLES >

| FINISHES >

| UPHOLSTERY >





An exquisite mastery and respect for the charm of tradition are expressed with elegance in the Tuscania club chair and ottoman, which with the gentle curves of their padding, represent an ideal addition to a classic living room, a modern study or a bedroom.

**Covers:** fabric / leather

**Legs finishes:** matt and glossy lacquer in the Galimberti Nino colour range

 | [VIEW ON WEBSITE](#) >

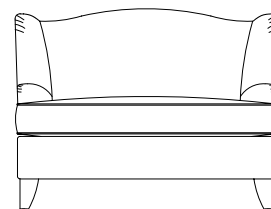

**TUS 42A**  
Club chair >

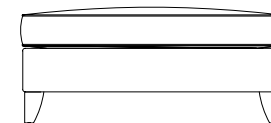

**TUS 43B**  
Ottoman >

 | [GALLERY](#) >

 | [ARMCHAIRS AND OTTOMANS](#) >

 | [FINISHES](#) >

 | [UPHOLSTERY](#) >

Club chair

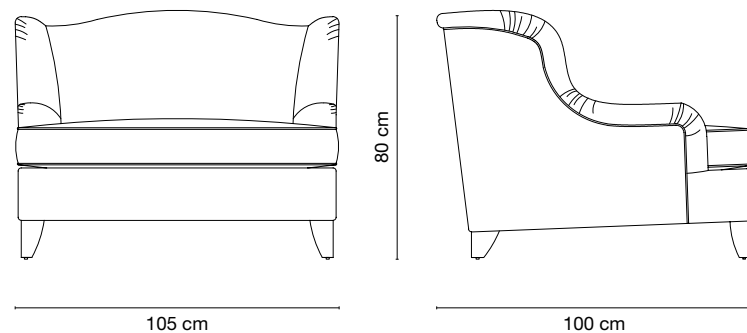
**TECHNICAL FEATURES****Structure:** solid wood**Seat and backrest:** padding in variable density high-resistance foam polyurethane / seat with elastic straps / non-removable cover**Cushion:** goose down divided into sections with high-resistance foam polyurethane inset / removable cover**Legs:** solid beech wood**Piping:** gros grain**Protective glides:** felt

Packaging	assembled	cbm.	kg.
Standard	●	1,10	42
Pallet	●	1,28	*
Wooden crate	●	1,60	*

\* weight to be confirmed

TUS 42A	Matt lacquered				Glossy lacquered			
	M001 M002 M003 M004 M005 M014	M006 M007 M011 M012 M013 M015 M018 M019	G001 G002 G003 G004 G005 G014	G006 G007 G011 G012 G013 G015 G018 G019				
Customer's fabric mtl. 8,50	●	●	●	●				
Fabric cat. A	●	●	●	●				
Fabric cat. B	●	●	●	●				
Fabric cat. C	●	●	●	●				
Fabric cat. D	●	●	●	●				
Leather	●	●	●	●				
Leather Lux	●	●	●	●				



| GALLERY &gt;

| ARMCHAIRS AND OTTOMANS &gt;

| FINISHES &gt;

| UPHOLSTERY &gt;

## Ottoman

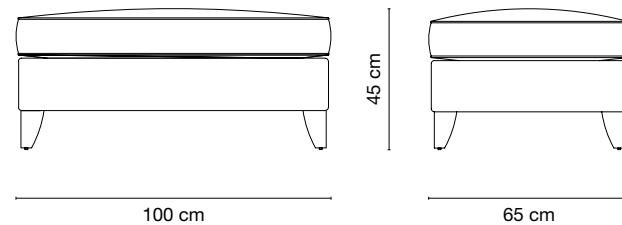
**TECHNICAL FEATURES****Structure:** solid wood**Seat:** padding in variable density high-resistance foam polyurethane / seat with elastic straps / non-removable cover**Cushion:** goose down divided into sections with high-resistance foam polyurethane inset / removable cover**Legs:** solid beech wood**Piping:** gros grain**Protective glides:** felt

Packaging	assembled	cbm.	kg.
Standard	●	0,44	22
Pallet	●	0,54	*
Wooden crate	●	0,72	*

*\* weight to be confirmed*

TUS 43B	Matt lacquered				Glossy lacquered			
	M001 M002 M003 M004 M005 M014	M006 M007 M011 M012 M013 M015 M018 M019	G001 G002 G003 G004 G005 G014	G006 G007 G011 G012 G013 G015 G018 G019				
Customer's fabric mtl. 3,50	●	●	●	●				
Fabric cat. A	●	●	●	●				
Fabric cat. B	●	●	●	●				
Fabric cat. C	●	●	●	●				
Fabric cat. D	●	●	●	●				
Leather	●	●	●	●				
Leather Lux	●	●	●	●				

[!\[\]\(b64b40baaee5acddc1eab8538ba84754\_img.jpg\) | GALLERY >](#)
[!\[\]\(84f47badaad7772cd95667a7c387a639\_img.jpg\) | ARMCHAIRS AND OTTOMANS >](#)
[!\[\]\(28f72b996fc97883dfd9d4e8b1b16b4e\_img.jpg\) | FINISHES >](#)
[!\[\]\(5d954b3e270654ad8ab0d5913161c03c\_img.jpg\) | UPHOLSTERY >](#)

## VIOLA | Ilenia Viscardi - 2020

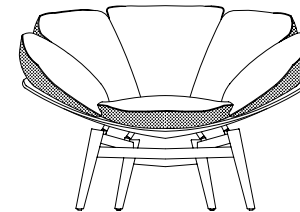

**VIO 72K**  
Club chair

A club chair with innovative and audacious lines and surprising textile workmanship, with its sculptural structure, iconic shape and comfortable and wide seat that manages to fill with charm and fantasy the scenery of the environment in which it may express its innate grit and undeniable versatility.

**Covers:** fabric

**Structure finishes:** natural walnut / honey walnut / tobacco walnut / moro walnut

**Metal finishes:** satin brass

 | [VIEW ON WEBSITE](#) >

 | [GALLERY](#) >

 | [ARMCHAIRS AND OTTOMANS](#) >

 | [FINISHES](#) >

 | [UPHOLSTERY](#) >

# VIOLA | Ilenia Viscardi - 2020

Club chair

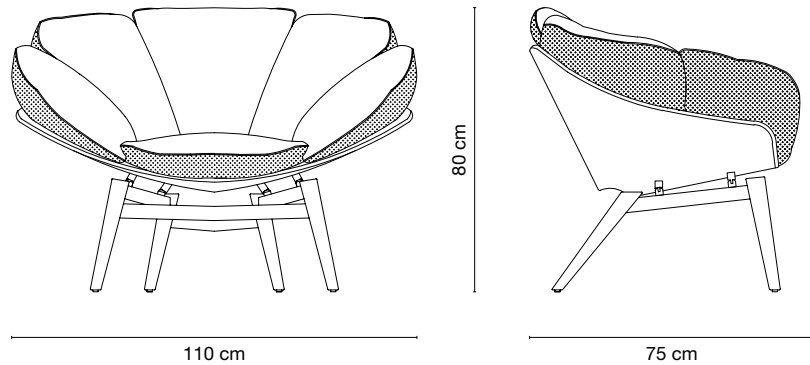

### TECHNICAL FEATURES

**Structure:** solid walnut

**Seat and backrest:** plywood panel covered with walnut wood veneer

**Cushion:** goose down divided into sections and polyester fiber lining / non-removable cover

**Piping:** gros grain

**Metal:** brass

**Protective glides:** felt

Packaging	assembled	cbm.	kg.
Standard	●	0,84	26
Pallet	●	0,98	*
Wooden crate	●	1,26	*

\* weight to be confirmed

VIO 72K	Matt walnut			
	Natural Walnut NO.020.NA	Honey Walnut NO.020.MI	Tobacco Walnut NO.020.TA	Moro Walnut NO.020.MO
Customer's fabric mtl. 3,20	●	●	●	●
Fabric cat. A	●	●	●	●
Fabric cat. B	●	●	●	●
Fabric cat. C	●	●	●	●
Fabric cat. D	●	●	●	●



| GALLERY >

| ARMCHAIRS AND OTTOMANS >

| FINISHES >

| UPHOLSTERY >



The delicate shapes of these beautiful pieces of furniture with a charming design and unique style will give a refined and timeless elegance to any interior, as modern as classical one. The sophisticated showcase, aerial and sunny, and the beautiful sideboard with a slight oriental touch, with the handles that are set like jewels in the structure of the doors, are supported by the base with minimal geometric lines embellished with the delicate sculptural decoration of the legs.

**Structure finishes:** matt and glossy lacquer in the Galimberti Nino colour range / natural walnut / honey walnut / matt and glossy tobacco walnut / moro walnut  
**Glass finishes:** bronze

 | [VIEW ON WEBSITE](#) >

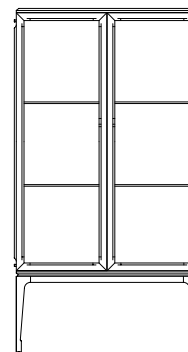

**YAN 24D**  
Showcase >



**YAN 33M**  
Storages >

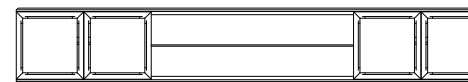

**YAN 35L**  
Storages >

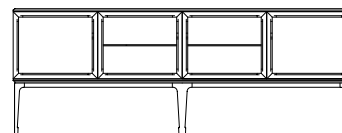

**YAN 48L**  
Storage >

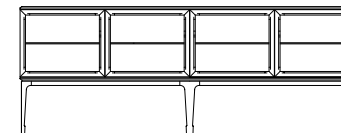

**YAN 44V**  
Storage >



 | [GALLERY](#) >

 | [STORAGES](#) >

 | [FINISHES](#) >

 | [UPHOLSTERY](#) >

Showcase

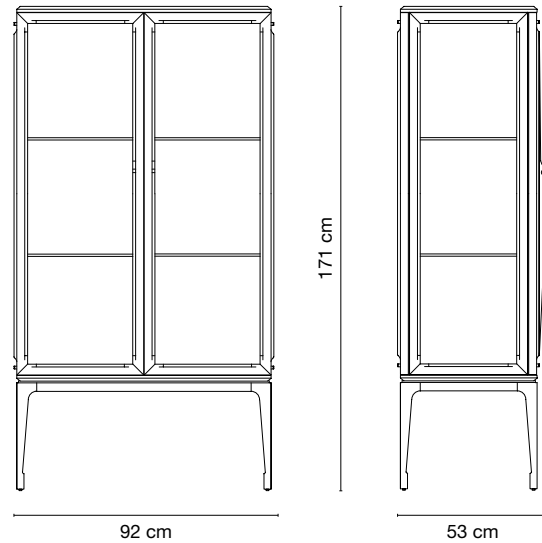

**TECHNICAL FEATURES**

**Structure:** toulipier solid wood and MDF panels / walnut solid wood and chipboard panels covered with walnut wood veneer

**Base:** solid toulipier wood / solid walnut

**Glass doors:** toulipier solid wood frames and glass 4 mm thick / walnut solid wood frames and glass 4 mm thick





**Shelves:** glass 8 mm thick

**Protective glides:** felt

Packaging	assembled	cbm.	kg.	not assembled	cbm.	kg.
Standard	●	1,08	98	●	0,94	98
Pallet	●	1,18	*	●	1,02	*
Wooden crate	●	1,54	*	●	1,36	*

\* weight to be confirmed

YAN 24D	Matt lacquered				Glossy lacquered				Matt walnut				Glossy walnut
	M001 M002 M003 M004 M005 M014	M006 M007 M011 M012 M013 M015 M018 M019	G001 G002 G003 G004 G005 G014	G006 G007 G011 G012 G013 G015 G018 G019	Natural Walnut NO.020.NA	Honey Walnut NO.020.MI	Tobacco Walnut NO.020.TA	Moro Walnut NO.020.MO	Tobacco Walnut NO.100.TA				
	●	●	●	●	●	●	●	●	●				

-  | GALLERY >
-  | STORAGES >
-  | FINISHES >
-  | UPHOLSTERY >

Marble top wall unit

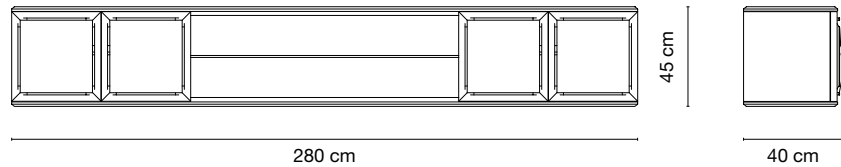
**TECHNICAL FEATURES**

**Top:** solid walnut frame with marble 20 mm. thick inset and chipboard panel covered with walnut wood veneer

**Structure:** walnut solid wood and MDF and chipboard panels covered with walnut wood veneer

**Glass doors:** walnut solid wood frames and glass 4 mm thick

**Shelf:** glass 8 mm thick

**Protective glides:** felt

Packaging	assembled	cbm.	kg.
Standard	●	0,92	184
Pallet	●	1,14	*
Wooden crate	●	1,44	*

\* weight to be confirmed

YAN 33M	Matt walnut			
	Natural Walnut NO.020.NA	Honey Walnut NO.020.MI	Tobacco Walnut NO.020.TA	Moro Walnut NO.020.MO
Bianco Carrara	●	●	●	●
Nero Marquinia	●	●	●	●
Breccia Medicea	●	●	●	●
Sahara Noir	●	●	●	●
Patagonia	●	●	●	●

[GALLERY](#)
[STORAGES](#)
[FINISHES](#)
[UPHOLSTERY](#)



Wall unit

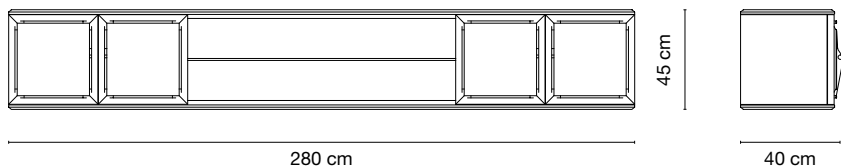

**TECHNICAL FEATURES**

**Structure:** walnut solid wood and MDF and chipboard panels covered with walnut wood veneer

**Glass doors:** walnut solid wood frames and glass 4 mm thick

**Shelf:** glass 8 mm thick

**Protective glides:** felt

Packaging	assembled	cbm.	kg.
Standard	●	0,72	94
Pallet	●	0,94	*
Wooden crate	●	1,24	*

\* weight to be confirmed

YAN 35L	Matt walnut			
	Natural Walnut NO.020.NA	Honey Walnut NO.020.MI	Tobacco Walnut NO.020.TA	Moro Walnut NO.020.MO
	●	●	●	●

- | GALLERY >
- | STORAGES >
- | FINISHES >
- | UPHOLSTERY >

4 doors sideboard

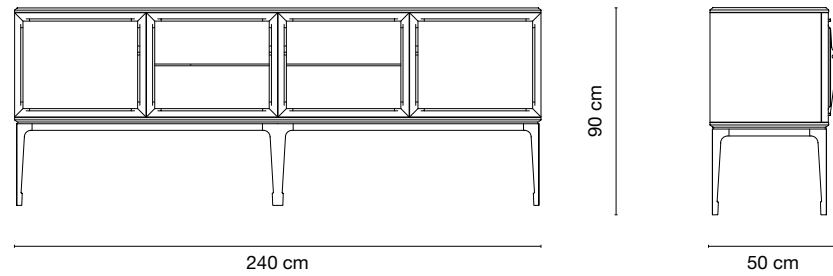

**TECHNICAL FEATURES**

**Structure:** walnut solid wood and MDF and chipboard panels covered with walnut wood veneer

**Base:** solid walnut

**Wooden doors:** walnut solid wood frames and MDF panels covered with walnut wood veneer

**Glass doors:** walnut solid wood frames and glass 4 mm thick

**Shelves:** glass 8 mm thick

**Protective glides:** felt

Packaging	assembled	cbm.	kg.	not assembled	cbm.	kg.
Standard	●	1,48	156	●	1,12	156
Pallet	●	1,70	*	●	1,34	*
Wooden crate	●	2,16	*	●	1,70	*

*\* weight to be confirmed*

YAN 48L	Matt walnut			
	Natural Walnut NO.020.NA	Honey Walnut NO.020.MI	Tobacco Walnut NO.020.TA	Moro Walnut NO.020.MO
	●	●	●	●



| GALLERY >

| STORAGES >

| FINISHES >

| UPHOLSTERY >

4 glass doors sideboard

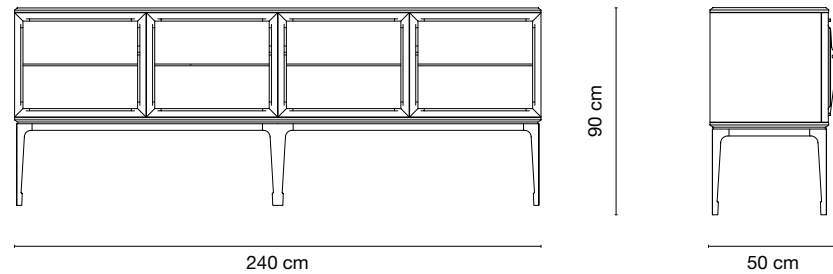

**TECHNICAL FEATURES**

**Structure:** walnut solid wood and MDF and chipboard panels covered with walnut wood veneer

**Base:** solid walnut

**Glass doors:** walnut solid wood frames and glass 4 mm thick

**Shelves:** glass 8 mm thick

**Protective glides:** felt

Packaging	assembled	cbm.	kg.	not assembled	cbm.	kg.
Standard	●	1,48	156	●	1,12	156
Pallet	●	1,70	*	●	1,34	*
Wooden crate	●	2,16	*	●	1,70	*

*\* weight to be confirmed*

YAN 44V	Matt walnut			
	Natural Walnut NO.020.NA	Honey Walnut NO.020.MI	Tobacco Walnut NO.020.TA	Moro Walnut NO.020.MO
	●	●	●	●



| GALLERY >

| STORAGES >

| FINISHES >

| UPHOLSTERY >



These stunning coffee and side tables will be a versatile addition to a modern home. Their geometric structure is made of walnut with a delicate sculptural decoration at the bottom of each of four legs. The top is in marble, whose natural veins will add a luxurious accent and a refined allure to any room in the house. These pieces are part of the Yang collection and can be combined with the others in the same series for a dynamic and sophisticated decoration.

**Marble top finishes:** Bianco Carrara natural / Nero Marquinia natural / Breccia Medicea natural / Sahara Noir polyester / Patagonia natural

**Structure finishes:** natural walnut / honey walnut / matt and glossy tobacco walnut / moro walnut

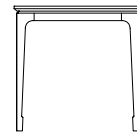

**YAN 01A**  
Side table 51 >

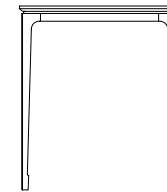

**YAN 02B**  
Side table 61 >



**YAN 03C**  
Coffee table 141 >

| [VIEW ON WEBSITE](#) >

| [GALLERY](#) >

| [COFFEE AND SIDE TABLES](#) >

| [FINISHES](#) >

| [UPHOLSTERY](#) >

Side table 51

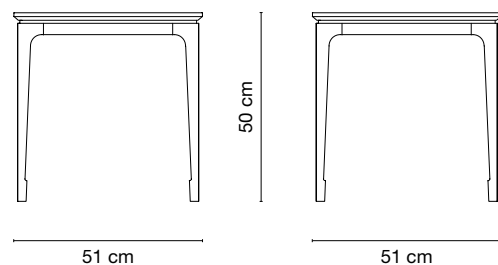

**TECHNICAL FEATURES**

**Top:** marble 20 mm thick

**Structure:** solid walnut

**Protective glides:** felt

Packaging	not assembled	cbm.	kg.
Standard**	●	0,14	34
Wooden crate	●	0,24	*

\* weight to be confirmed \*\* marble in wooden crate packaging

YAN 01A	Matt walnut				Glossy walnut
	Natural Walnut NO.020.NA	Honey Walnut NO.020.MI	Tobacco Walnut NO.020.TA	Moro Walnut NO.020.MO	Tobacco Walnut NO.100.TA
Bianco Carrara	●	●	●	●	●
Nero Marquina	●	●	●	●	●
Breccia Medicea	●	●	●	●	●
Sahara Noir	●	●	●	●	●
Patagonia	●	●	●	●	●



| GALLERY >

| COFFEE AND SIDE TABLES >

| FINISHES >

| UPHOLSTERY >

Side table 61

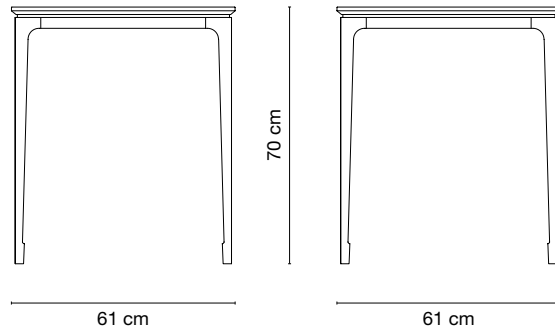

**TECHNICAL FEATURES**

**Top:** marble 20 mm thick

**Structure:** solid walnut

**Protective glides:** felt

Packaging	not assembled	cbm.	kg.
Standard**	●	0,16	39
Wooden crate	●	0,26	*

\* weight to be confirmed \*\* marble in wooden crate packaging

YAN 02B	Matt walnut				Glossy walnut
	Natural Walnut NO.020.NA	Honey Walnut NO.020.MI	Tobacco Walnut NO.020.TA	Moro Walnut NO.020.MO	Tobacco Walnut NO.100.TA
Bianco Carrara	●	●	●	●	●
Nero Marquina	●	●	●	●	●
Breccia Medicea	●	●	●	●	●
Sahara Noir	●	●	●	●	●
Patagonia	●	●	●	●	●



| GALLERY >

| COFFEE AND SIDE TABLES >

| FINISHES >

| UPHOLSTERY >

## Coffee table 141

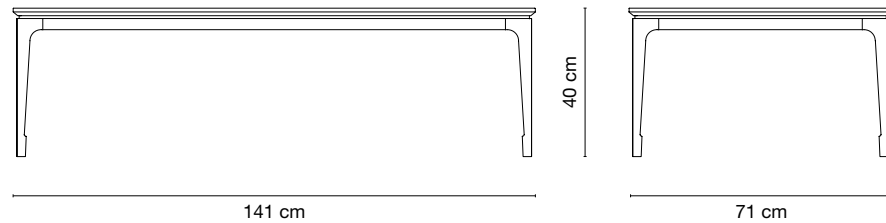
**TECHNICAL FEATURES**

Top: marble 20 mm thick

Structure: solid walnut

Protective glides: felt

Packaging	not assembled	cbm.	kg.	
Standard**	●	0,24	88	
Wooden crate	●	0,34	*	

\* weight to be confirmed \*\* marble in wooden crate packaging

YAN 03C	Matt walnut				Glossy walnut	
	Natural Walnut NO.020.NA	Honey Walnut NO.020.MI	Tobacco Walnut NO.020.TA	Moro Walnut NO.020.MO	Tobacco Walnut NO.100.TA	
Bianco Carrara	●	●	●	●	●	
Nero Marquina	●	●	●	●	●	
Breccia Medicea	●	●	●	●	●	
Sahara Noir	●	●	●	●	●	
Patagonia	●	●	●	●	●	

 | GALLERY >

 | COFFEE AND SIDE TABLES >

 | FINISHES >

 | UPHOLSTERY >



Bed with a refined and timeless design, Zaffiro stands out for being an extremely versatile piece which presence will impose itself in every bedroom, both classic and contemporary. It's rich in precious ornamental details and with structural characteristics such as the vertical profiles of the headboard, the soft curves and the feet covered in metal, you will not be able to resist to its unsurpassed charm.

**Covers:** fabric / leather

**Legs finishes:** bronze painted / satin brass

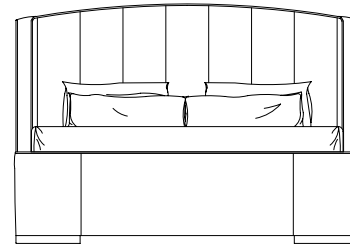

**ZAF 03C**  
Bed 160

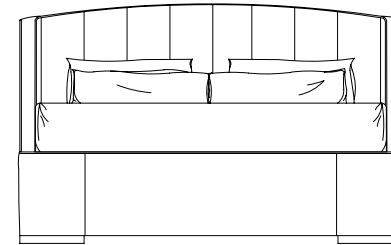

**ZAF 01A**  
Bed 180

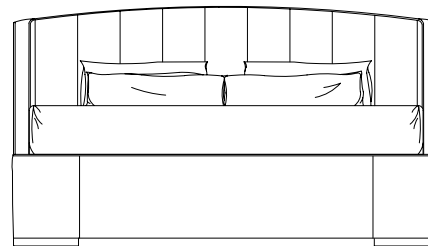

**ZAF 02B**  
Bed 200



| [VIEW ON WEBSITE](#) >

| [GALLERY](#) >

| [BEDS](#) >

| [FINISHES](#) >

| [UPHOLSTERY](#) >



## ZAFFIRO | Studio Galimberti - 2014

Bed 160

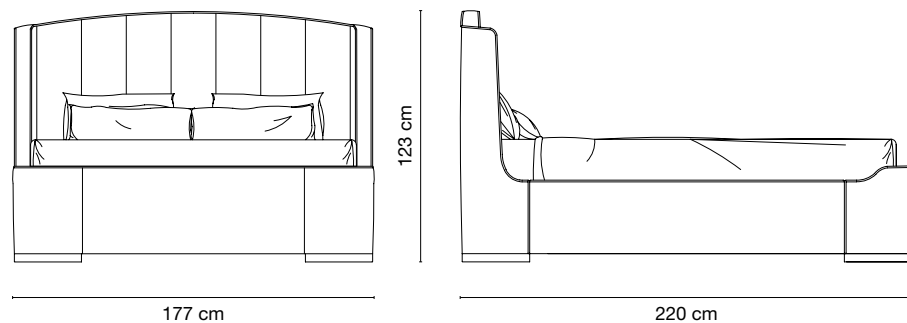

## TECHNICAL FEATURES

**Structure:** solid wood and plywood and MDF panels**Legs:** brass covered plywood panels**Headboard, footboard and sides:** padding in variable density high-resistance foam polyurethane / non-removable cover**Piping:** gros grain**Mattress' support:** metal bed frame with wooden slats**Protective glides:** felt**Mattress (not included):** size 160 x 200 x h.22 cm

Cushions and bed set not included

Packaging	not assembled	cbm.	kg.
Standard	●	1,54	123
Wooden crate**	●	2,34	*

\* weight to be confirmed \*\* slatted base not included

ZAF 03C	Brass	
	Bronze finish ME.BRO.20	Satin ME.OTT.20
Customer's fabric mtl. 10,00	●	●
Fabric cat. A	●	●
Fabric cat. B	●	●
Fabric cat. C	●	●
Fabric cat. D	●	●
Leather	●	●
Leather Lux	●	●



| GALLERY &gt;

| BEDS &gt;

| FINISHES &gt;

| UPHOLSTERY &gt;

## ZAFFIRO | Studio Galimberti - 2014

Bed 180

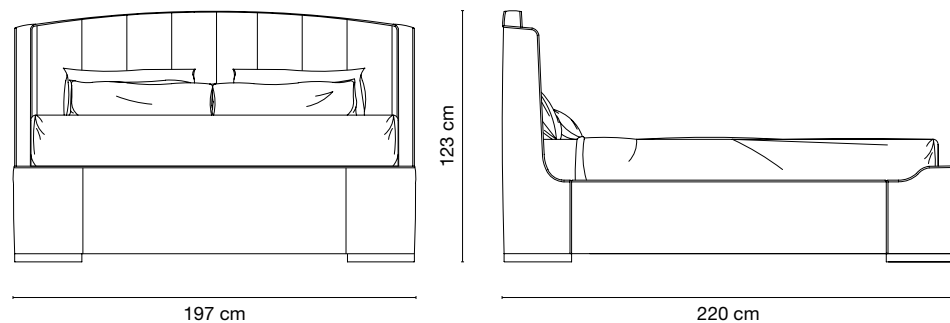
**TECHNICAL FEATURES****Structure:** solid wood and plywood and MDF panels**Legs:** brass covered plywood panels**Headboard, footboard and sides:** padding in variable density high-resistance foam polyurethane / non-removable cover**Piping:** gros grain**Mattress' support:** metal bed frame with wooden slats**Protective glides:** felt**Mattress (not included):** size 180 x 200 x h.22 cm

Cushions and bed set not included

Packaging	not assembled	cbm.	kg.
Standard	●	1,72	133
Wooden crate**	●	2,62	*

\* weight to be confirmed \*\* slatted base not included

ZAF 01A	Brass	
	Bronze finish ME.BRO.20	Satin ME.OTT.20
Customer's fabric mtl. 10,00	●	●
Fabric cat. A	●	●
Fabric cat. B	●	●
Fabric cat. C	●	●
Fabric cat. D	●	●
Leather	●	●
Leather Lux	●	●



| GALLERY &gt;

| BEDS &gt;

| FINISHES &gt;

| UPHOLSTERY &gt;

## ZAFFIRO | Studio Galimberti - 2014

Bed 200

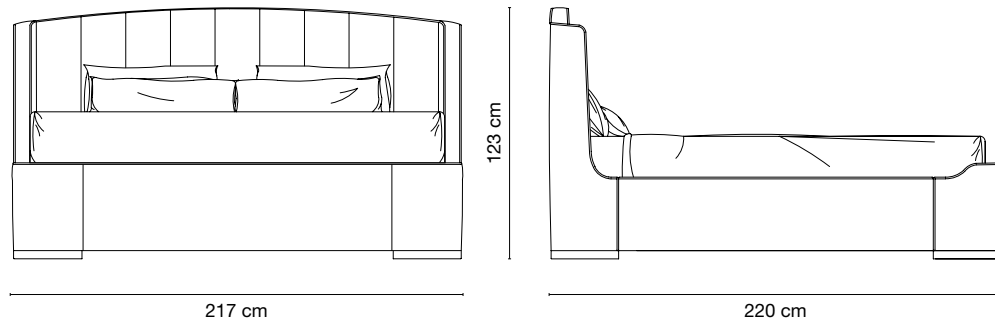
**TECHNICAL FEATURES****Structure:** solid wood and plywood and MDF panels**Legs:** brass covered plywood panels**Headboard, footboard and sides:** padding in variable density high-resistance foam polyurethane / non-removable cover**Piping:** gros grain**Mattress' support:** metal bed frame with wooden slats**Protective glides:** felt**Mattress (not included):** size 200 x 200 x h.22 cm

Cushions and bed set not included

Packaging	not assembled	cbm.	kg.
Standard	●	1,90	149
Wooden crate**	●	2,86	*

\* weight to be confirmed \*\* slatted base not included

ZAF 02B	Brass	
	Bronze finish ME.BRO.20	Satin ME.OTT.20
Customer's fabric mtl. 11,20	●	●
Fabric cat. A	●	●
Fabric cat. B	●	●
Fabric cat. C	●	●
Fabric cat. D	●	●
Leather	●	●
Leather Lux	●	●



| GALLERY &gt;

| BEDS &gt;

| FINISHES &gt;

| UPHOLSTERY &gt;

ZAFFIRO ALTO | Studio Galimberti - 2014



Bed with a refined and timeless design, Zaffiro Alto stands out for being an extremely versatile piece which presence will impose itself in every bedroom, both classic and contemporary. It's rich in precious ornamental details and with structural characteristics such as the vertical profiles of the headboard, the soft curves and the feet covered in metal, you will not be able to resist to its unsurpassed charm.

**Covers:** fabric / leather

**Legs finishes:** bronze painted / satin brass



**ZAH 13C**  
Bed 160

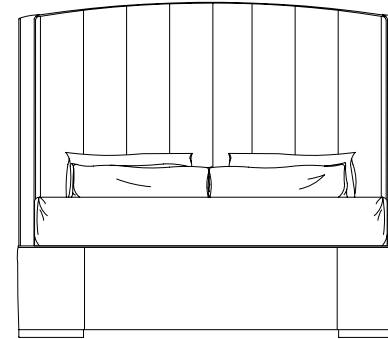

**ZAH 11A**  
Bed 180

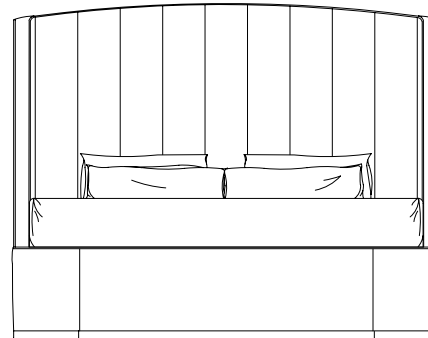



**ZAH 12B**  
Bed 200



 | [VIEW ON WEBSITE](#) >

 | [GALLERY](#) >

 | [BEDS](#) >

 | [FINISHES](#) >

 | [UPHOLSTERY](#) >

## ZAFFIRO ALTO

Studio Galimberti - 2014

Bed 160

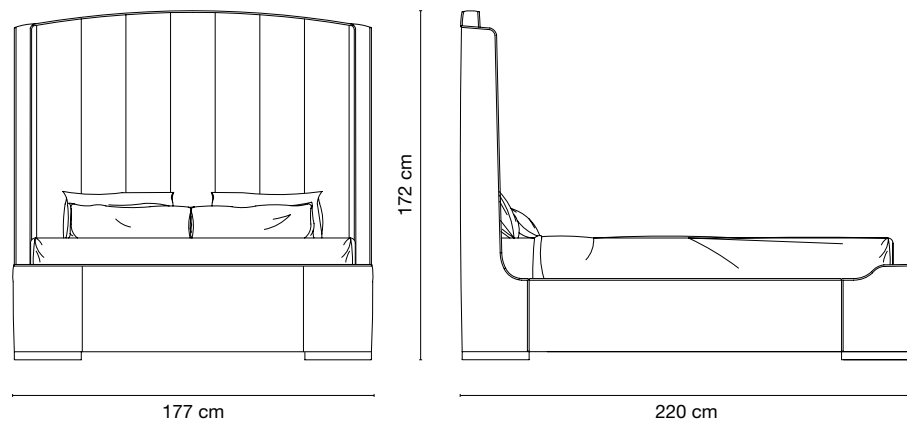
**TECHNICAL FEATURES****Structure:** solid wood and plywood and MDF panels**Legs:** brass covered plywood panels**Headboard, footboard and sides:** padding in variable density high-resistance foam polyurethane / non-removable cover**Piping:** gros grain**Mattress' support:** metal bed frame with wooden slats**Protective glides:** felt**Mattress (not included):** size 160 x 200 x h.22 cm

Cushions and bed set not included

Packaging	not assembled	cbm.	kg.
Standard	●	1,90	139
Wooden crate**	●	2,82	*

\* weight to be confirmed \*\* slatted base not included

ZAH 13C	Brass	
	Bronze finish ME.BRO.20	Satin ME.OTT.20
Customer's fabric mtl. 13,00	●	●
Fabric cat. A	●	●
Fabric cat. B	●	●
Fabric cat. C	●	●
Fabric cat. D	●	●
Leather	●	●
Leather Lux	●	●



| GALLERY &gt;

| BEDS &gt;

| FINISHES &gt;

| UPHOLSTERY &gt;

## ZAFFIRO ALTO | Studio Galimberti - 2014

Bed 180

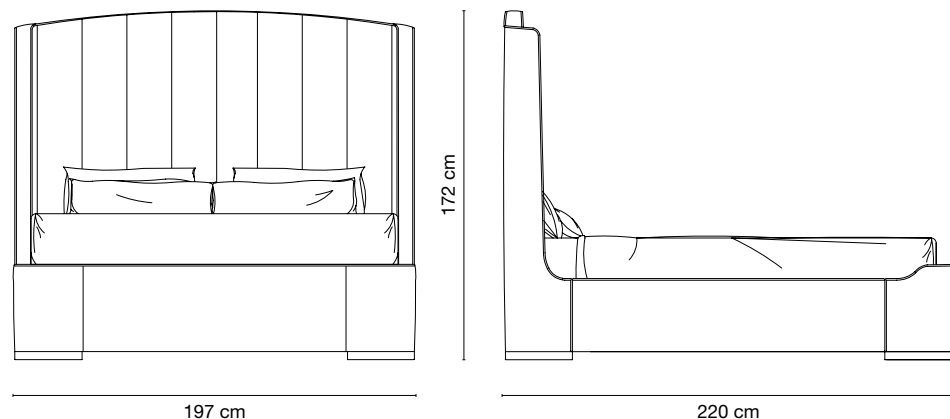
**TECHNICAL FEATURES****Structure:** solid wood and plywood and MDF panels**Legs:** brass covered plywood panels**Headboard, footboard and sides:** padding in variable density high-resistance foam polyurethane / non-removable cover**Piping:** gros grain**Mattress' support:** metal bed frame with wooden slats**Protective glides:** felt**Mattress (not included):** size 180 x 200 x h.22 cm

Cushions and bed set not included

Packaging	not assembled	cbm.	kg.
Standard	●	2,12	149
Wooden crate**	●	3,14	*

\* weight to be confirmed \*\* slatted base not included

ZAH 11A	Brass	
	Bronze finish ME.BRO.20	Satin ME.OTT.20
Customer's fabric mtl. 13,00	●	●
Fabric cat. A	●	●
Fabric cat. B	●	●
Fabric cat. C	●	●
Fabric cat. D	●	●
Leather	●	●
Leather Lux	●	●



| GALLERY &gt;

| BEDS &gt;

| FINISHES &gt;

| UPHOLSTERY &gt;

# ZAFFIRO ALTO

 | Studio Galimberti - 2014

Bed 200

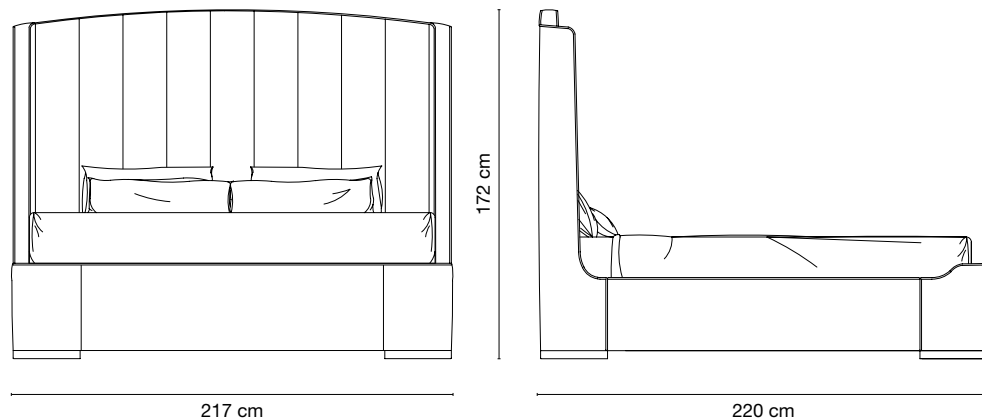
**TECHNICAL FEATURES****Structure:** solid wood and plywood and MDF panels**Legs:** brass covered plywood panels**Headboard, footboard and sides:** padding in variable density high-resistance foam polyurethane / non-removable cover**Piping:** gros grain**Mattress' support:** metal bed frame with wooden slats**Protective glides:** felt**Mattress (not included):** size 200 x 200 x h.22 cm

Cushions and bed set not included

Packaging	not assembled	cbm.	kg.
Standard	●	2,40	165
Wooden crate**	●	3,48	*

\* weight to be confirmed \*\* slatted base not included

ZAH 12B	Brass	
	Bronze finish ME.BRO.20	Satin ME.OTT.20
Customer's fabric mtl. 14,70	●	●
Fabric cat. A	●	●
Fabric cat. B	●	●
Fabric cat. C	●	●
Fabric cat. D	●	●
Leather	●	●
Leather Lux	●	●



| GALLERY &gt;

| BEDS &gt;

| FINISHES &gt;

| UPHOLSTERY &gt;

ZIRCONE | Studio Galimberti - 2018



Extraordinarily versatile design of Zircon table allows it to be placed in any dining room, both classic and contemporary. This elegant table with a soft oval shape is decorated with metal ferrules to complete the fascinating legs with a unique and sophisticated touch.

**Tops and structure finishes:** matt and glossy lacquer in the Galimberti Nino colour range  
**Metal finishes:** bronze painted / satin brass



**ZIR 31A**  
Dining table >

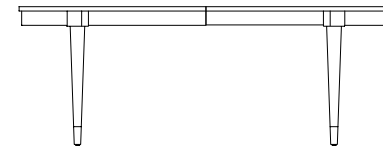

**ZIR 32B**  
Extendable dining table >

 | [VIEW ON WEBSITE](#) >

 | [GALLERY](#) >

 | [DINING TABLES](#) >

 | [FINISHES](#) >

 | [UPHOLSTERY](#) >



ZIRCONE | Studio Galimberti - 2018

Dining table

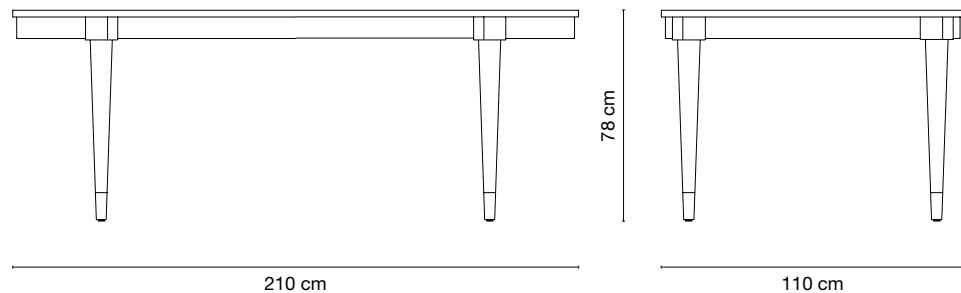





**TECHNICAL FEATURES**

**Top:** chipboard panel  
**Undermount structure:** plywood panels and toulipier massive wood  
**Legs:** toulipier massive wood  
**Legs ferrules:** brass  
**Protective glides:** felt

Packaging	not assembled	cbm.	kg.
Standard	•	0,50	59
Wooden crate	•	0,92	*

\* weight to be confirmed

ZIR 31A	Matt lacquered				Glossy lacquered			
	M001 M002 M003 M004 M005 M014	M006 M007 M011 M012 M013 M015 M018 M019	G001 G002 G003 G004 G005 G014	G006 G007 G011 G012 G013 G015 G018 G019				
	•	•	•	•				

-  | GALLERY >
-  | DINING TABLES >
-  | FINISHES >
-  | UPHOLSTERY >

ZIRCONE | Studio Galimberti - 2018

Extendable dining table

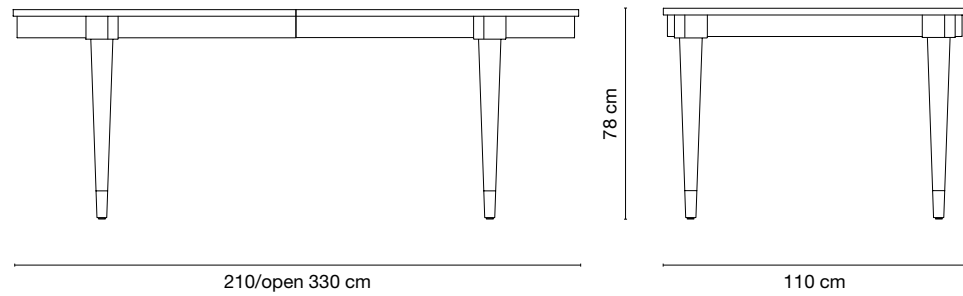

**TECHNICAL FEATURES**

- Top:** chipboard panel
- Undermount structure:** plywood panels and toulipier massive wood
- Legs:** toulipier massive wood
- Extension mechanism:** aluminum sliding guides
- Extensions:** plywood and chipboard panels .externally housed
- Legs ferrules:** brass
- Protective glides:** felt

Packaging	not assembled	cbm.	kg.
Standard	•	0,74	100
Wooden crate	•	1,36	*

\* weight to be confirmed

ZIR 32B	Matt lacquered				Glossy lacquered			
	M001 M002 M003 M004 M005 M014	M006 M007 M011 M012 M013 M015 M018 M019	G001 G002 G003 G004 G005 G014	G006 G007 G011 G012 G013 G015 G018 G019				
	•	•	•	•				

- | GALLERY >
- | DINING TABLES >
- | FINISHES >
- | UPHOLSTERY >



This stunning cushion will be a superb complement to any of our sofas or armchairs. Chosen to accompany with the same colour or to enliven a minimalist, neutral-tone seating with the strong tonality, this cushion will be an elegant addition for contemporary or classic decor.

**Covers:** fabric

 | [VIEW ON WEBSITE](#) >



**CUS 71A**  
Cushion 35x25 >



**CUS 72B**  
Cushion 50x30 >



**CUS 73C**  
Cushion 40x40 >



**CUS 74D**  
Cushion 50x50 >



**CUS 76F**  
Cushion 70x40 >

 | [FINISHES](#) >

 | [UPHOLSTERY](#) >

# Galimberti Nino

## CUSHION

Cushion 35x25



### TECHNICAL FEATURES

Cushion: goose down divided into sections and polyester fiber lining / removable cover

CUS 71A		
Customer's fabric mtl. 0,40	•	
Fabric cat. A	•	
Fabric cat. B	•	
Fabric cat. C	•	
Fabric cat. D	•	

 FINISHES >

 UPHOLSTERY >

## CUSHION

Cushion 50x30

**TECHNICAL FEATURES**

Cushion: goose down divided into sections and polyester fiber lining / removable cover

CUS 72B		
Customer's fabric mtl. 0,40	•	
Fabric cat. A	•	
Fabric cat. B	•	
Fabric cat. C	•	
Fabric cat. D	•	



FINISHES



UPHOLSTERY



# Galimberti Nino

## CUSHION

Cushion 40x40

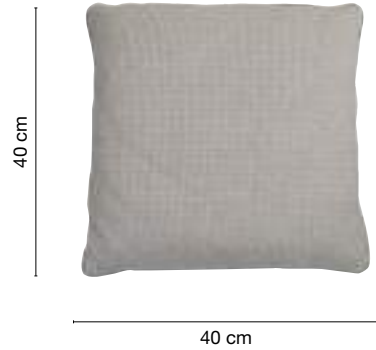



### TECHNICAL FEATURES

Cushion: goose down divided into sections and polyester fiber lining / removable cover

CUS 73C		
Customer's fabric mtl. 0,50	•	
Fabric cat. A	•	
Fabric cat. B	•	
Fabric cat. C	•	
Fabric cat. D	•	



 FINISHES >

 UPHOLSTERY >

# Galimberti Nino

## CUSHION

Cushion 50x50

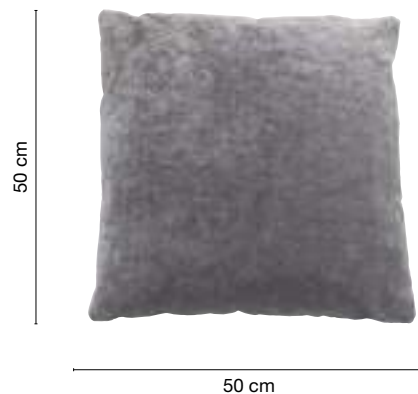

### TECHNICAL FEATURES

Cushion: goose down divided into sections and polyester fiber lining / removable cover

CUS 74D		
Customer's fabric mtl. 0,60	•	
Fabric cat. A	•	
Fabric cat. B	•	
Fabric cat. C	•	
Fabric cat. D	•	

 FINISHES >

 UPHOLSTERY >

# Galimberti Nino CUSHION

Cushion 70x40





### TECHNICAL FEATURES

Cushion: goose down divided into sections and polyester fiber lining / removable cover

CUS 76F		
Customer's fabric mtl. 1,00	•	
Fabric cat. A	•	
Fabric cat. B	•	
Fabric cat. C	•	
Fabric cat. D	•	



 FINISHES >

 UPHOLSTERY >





The use of exclusive materials is combined with the use of cutting-edge technologies such as the Bonnel springing in which each spring is made of steel wire, high-resistance phosphated and electronically tempered. The pocket coils mattress, created for the prevention of classic column disorders, has each spring covered in Fibertex to be independent of the others and work proportionally to the pressure exerted on it. The weight is thus optimally distributed over the entire surface of the mattress. The 7 zones of differentiated support also allow an absolute customization of the rest.

**Covers:** fabric with antibacterial and antifungal treatment and the stain resistant protection Teflon Dupont

 | [VIEW ON WEBSITE](#) >



**MAT 41E**  
Orthopaedic mattress 160 >



**MAT 45F**  
Pocket coils mattress 160 >



**MAT 51A**  
Orthopaedic mattress 180 >



**MAT 53C**  
Pocket coils mattress 180 >



**MAT 52B**  
Orthopaedic mattress 200 >



**MAT 54D**  
Pocket coils mattress 200 >

 | [FINISHES](#) >

 | [UPHOLSTERY](#) >

# Galimberti Nino MATTRESS

Orthopaedic mattress 160



### TECHNICAL FEATURES

**Structure:** Bonnel system with springs 2.20 mm diameter steel wire / high quality felt, heat set and insulating / box system with CFC-free non-deformable expanded polyurethane

Packaging	assembled	cbm.	kg.
Standard	•	0,86	37

MAT 41E		
	•	



 FINISHES >

 UPHOLSTERY >

# Galimberti Nino MATTRESS

Pocket coils mattress 160



### TECHNICAL FEATURES

**Structure:** 1,8 and 2,0 mm diameter steel wire independent pocket coils in 7 differentiated weight-bearing zones / high quality felt, heat set and insulating / box system with CFC-free non-deformable expanded polyurethane

Packaging	assembled	cbm.	kg.
Standard	•	0,86	47

MAT 45F		
	•	



 FINISHES >

 UPHOLSTERY >

# Galimberti Nino MATTRESS

Orthopaedic mattress 180



### TECHNICAL FEATURES

**Structure:** Bonnel system with springs 2.20 mm diameter steel wire / high quality felt, heat set and insulating / box system with CFC-free non-deformable expanded polyurethane

Packaging	assembled	cbm.	kg.
Standard	•	0,96	41

MAT 51A		
	•	



 FINISHES >

 UPHOLSTERY >

# Galimberti Nino

## MATTRESS

Pocket coils mattress 180



### TECHNICAL FEATURES

**Structure:** 1,8 and 2,0 mm diameter steel wire independent pocket coils in 7 differentiated weight-bearing zones / high quality felt, heat set and insulating / box system with CFC-free non-deformable expanded polyurethane

Packaging	assembled	cbm.	kg.
Standard	•	0,96	51

MAT 53C		
	•	



 FINISHES >

 UPHOLSTERY >

# Galimberti Nino MATTRESS

Orthopaedic mattress 200



### TECHNICAL FEATURES

**Structure:** Bonnel system with springs 2.20 mm diameter steel wire / high quality felt, heat set and insulating / box system with CFC-free non-deformable expanded polyurethane

Packaging	assembled	cbm.	kg.	
Standard	•	1,06	45	

MAT 52B		
	•	



 FINISHES >

 UPHOLSTERY >

# Galimberti Nino MATTRESS

Pocket coils mattress 200



### TECHNICAL FEATURES

**Structure:** 1,8 and 2,0 mm diameter steel wire independent pocket coils in 7 differentiated weight-bearing zones / high quality felt, heat set and insulating / box system with CFC-free non-deformable expanded polyurethane

Packaging	assembled	cbm.	kg.
Standard	•	1,06	56

MAT 54D		
	•	



 FINISHES >

 UPHOLSTERY >

# FABRIC



	Linear meter fabric	
	Height 140 cm	
Fabric cat. A	•	
Fabric cat. B	•	
Fabric cat. C	•	
Fabric cat. D	•	

 FINISHES >

 UPHOLSTERY >



FINISHES

WOOD

MATT WALNUT



**NO.020.NA**  
Natural



**NO.020.MI**  
Honey



**NO.020.TA**  
Tobacco



**NO.020.MO**  
Moro

GLOSSY WALNUT

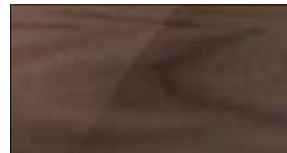

**NO.100.TA**  
Tobacco

ASH WOOD



**FR.020.BI**  
White



**FR.020.TA**  
Tobacco



**FR.020.EB**  
Ebonized



**FR.020.MO**  
Moro

FINISHES

MARBLE

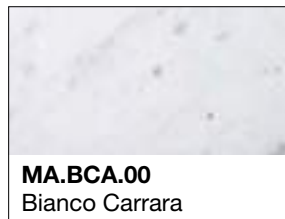

STONEECO



METAL

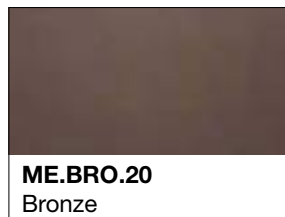

GLASS

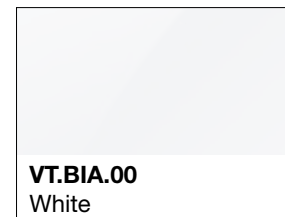
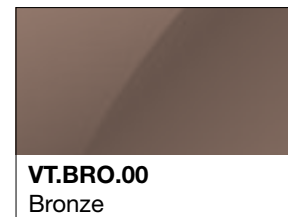









## FINISHES

## LACQUERED

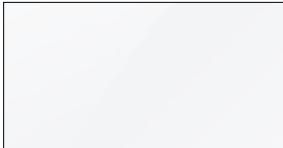
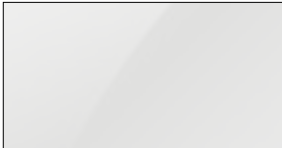
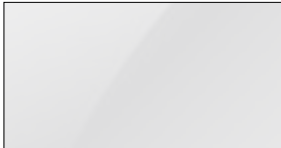
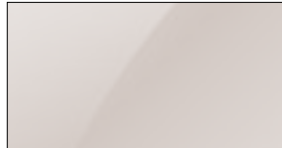
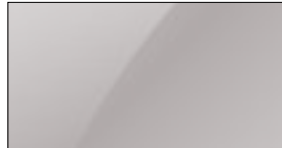
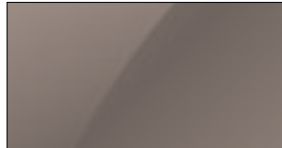
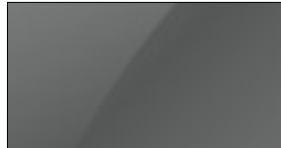
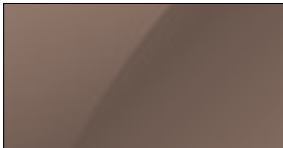
## MATT

 <b>M001</b> Chalk White	 <b>M002</b> Warm White	 <b>M003</b> Grey White	 <b>M004</b> Cream	 <b>M014</b> Cloud Grey	 <b>M005</b> Dove Grey	 <b>M015</b> Lead Grey
 <b>M018</b> Moka	 <b>M012</b> Black Brown	 <b>M013</b> Black	 <b>M019</b> Black Green	 <b>M007</b> Air Blue	 <b>M006</b> Lemon Yellow	 <b>M011</b> Brown Red

## GLOSSY

 <b>G001</b> Chalk White	 <b>G002</b> Warm White	 <b>G003</b> Grey White	 <b>G004</b> Cream	 <b>G014</b> Cloud Grey	 <b>G005</b> Dove Grey	 <b>G015</b> Lead Grey
 <b>G018</b> Moka	 <b>G012</b> Black Brown	 <b>G013</b> Black	 <b>G019</b> Black Green	 <b>G007</b> Air Blue	 <b>G006</b> Lemon Yellow	 <b>G011</b> Brown Red

## UPHOLSTERY



## IVORY CARAMEL

## CODES

- |               |               |
|---------------|---------------|
| 1. FD20 101D  | 23. FD20 123B |
| 2. FD20 102B  | 24. FD20 124B |
| 3. FD20 103C  | 25. FD20 125B |
| 4. FD20 104A  | 26. FD20 126A |
| 5. FD20 105B  | 27. FD20 127C |
| 6. FD20 106B  |               |
| 7. FD20 107B  | A. LD20 101P  |
| 8. FD20 108C  | B. LD20 102L  |
| 9. FD20 109D  | C. LD20 103L  |
| 10. FD20 110A | D. LD20 104P  |
| 11. FD20 111B | E. LD20 105L  |
| 12. FD20 112B | F. LD20 106P  |
| 13. FD20 113B |               |
| 14. FD20 114B |               |
| 16. FD20 116A |               |
| 17. FD20 117A |               |
| 18. FD20 118B |               |
| 19. FD20 119A |               |
| 20. FD20 120A |               |
| 21. FD20 121C |               |
| 22. FD20 122C |               |

## UPHOLSTERY

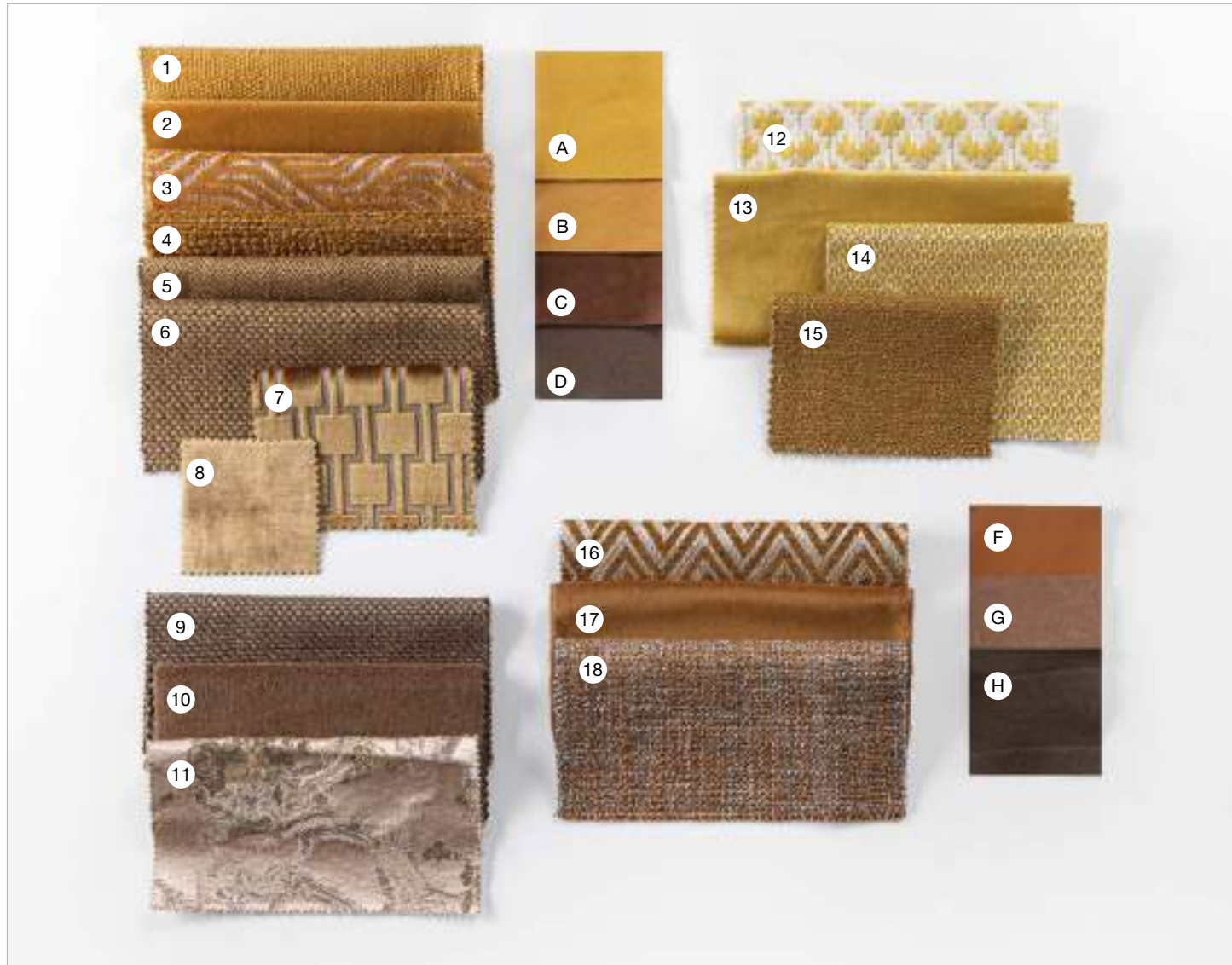

## YELLOW SAND

## CODES

1. FD20 201A	A. LD20 201P
2. FD20 202B	B. LD20 202L
3. FD20 203B	C. LD20 203L
4. FD20 204A	D. LD20 204P
5. FD20 205A	E. LD20 205P
6. FD20 206B	F. LD20 206L
7. FD20 207C	F. LD20 207P
8. FD20 208B	
9. FD20 209B	
10. FD20 210C	
11. FD20 211D	
12. FD20 212D	
13. FD20 213A	
14. FD20 214B	
15. FD20 215C	
16. FD20 216B	
17. FD20 217B	
18. FD20 218B	

## UPHOLSTERY



## ORANGE BRICK

## CODES

1. FD20 801B
2. FD20 802D
3. FD20 803B
4. FD20 804A
5. FD20 805B
6. FD20 806C
7. FD20 807A
8. FD20 808C
9. FD20 809A
10. FD20 810B
11. FD20 811B
12. FD20 812B
13. FD20 813A
14. FD20 814C
15. FD20 815C
16. FD20 816C

- A. LD20 801L
- B. LD20 802L
- C. LD20 803P
- D. LD20 804P

## UPHOLSTERY



## PINK ROSE

## CODES

1. FD20 501B
2. FD20 502B
3. FD20 503B
4. FD20 504C
5. FD20 505A
6. FD20 506B
7. FD20 507A
8. FD20 508A
9. FD20 509D
10. FD20 510A
11. FD20 511B
12. FD20 512C
13. FD20 513C
14. FD20 514C
15. FD20 515B

- A. LD20 501P
- B. LD20 502L
- C. LD20 503P

## UPHOLSTERY



## GREEN FOREST

## CODES

1. FD20 601D
2. FD20 602A
3. FD20 603B
4. FD20 604A
5. FD20 605D
6. FD20 606B
7. FD20 607B
8. FD20 608A
9. FD20 609B
10. FD20 610B
11. FD20 611B
12. FD20 612B
13. FD20 613B
14. FD20 614A
15. FD20 615B
16. FD20 616B
17. FD20 617B
18. FD20 618C

- A. LD20 601L
- B. LD20 602L
- C. LD20 603P
- D. LD20 604P



## UPHOLSTERY



## BLUE OCEAN

## CODES

1. FD20 701B
2. FD20 702D
3. FD20 703C
4. FD20 704B
5. FD20 705B
6. FD20 706A
7. FD20 707C
8. FD20 708B
9. FD20 709B
10. FD20 710B
11. FD20 711A
12. FD20 712A
13. FD20 713D
14. FD20 714C
16. FD20 716B
17. FD20 717C
18. FD20 718C
19. FD20 719B
20. FD20 720B
21. FD20 721B

- A. LD20 701P
- B. LD20 702L
- C. LD20 703P

## UPHOLSTERY



## BROWN CHOCOLATE

## CODES

1. FD20 301A
2. FD20 302A
3. FD20 303A
4. FD20 304B
5. FD20 305A
6. FD20 306B
7. FD20 307B
8. FD20 308A
9. FD20 309B
10. FD20 310A
11. FD20 311B
12. FD20 312A
13. FD20 313B
14. FD20 314B

- A. LD20 301P
- B. LD20 302L
- C. LD20 303L
- D. LD20 304P

## UPHOLSTERY



## SILVER STONE

## CODES

1. FD20 401D
2. FD20 402A
3. FD20 403B
4. FD20 404B
5. FD20 405C
6. FD20 406D
7. FD20 407A
8. FD20 408A
9. FD20 409B
10. FD20 410B
11. FD20 411A
12. FD20 412A
13. FD20 413B
15. FD20 415B
16. FD20 416B
17. FD20 417C
18. FD20 418C
19. FD20 419B
20. FD20 420B

- A. LD20 401P
- B. LD20 402L
- C. LD20 403P
- D. LD20 404L
- E. LD20 405P



## MISTIC BLUE

### CODES

1. FD22 619B
2. FD22 621B
3. FD22 620B
4. FD22 219C
5. FD22 724A
6. FD22 725B
7. FD22 622C
8. FD22 727B
9. FD22 726B
10. FD22 220D

## UPHOLSTERY



## AMBER ALMOND

**CODES**

1. FD22 723D
2. FD22 134C
3. FD22 129B
4. FD22 128A
5. FD22 131B
6. FD22 132B
7. FD22 219C
8. FD22 133B
9. FD22 135D
10. FD22 130D



PIPING

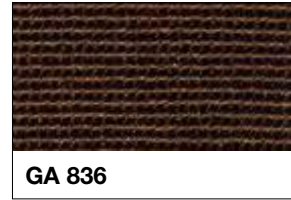
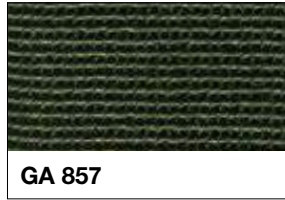
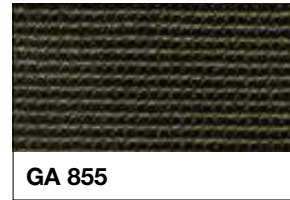
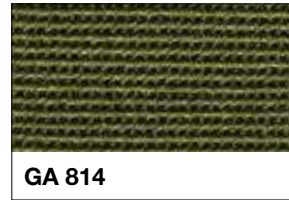
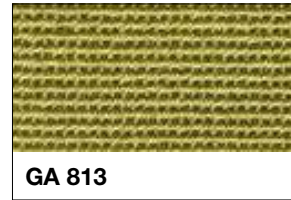
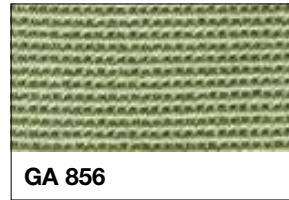
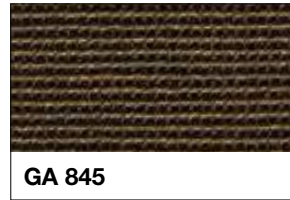
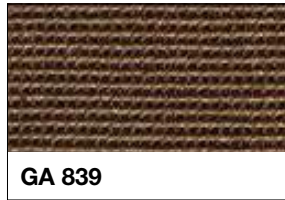
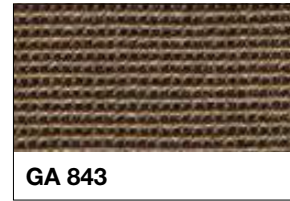
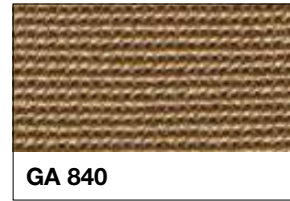
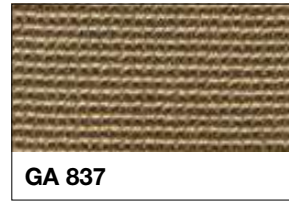
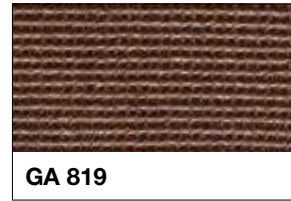
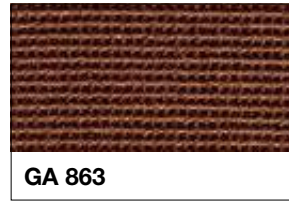
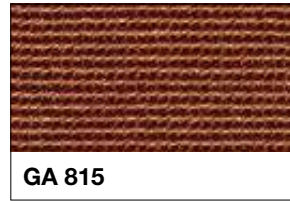
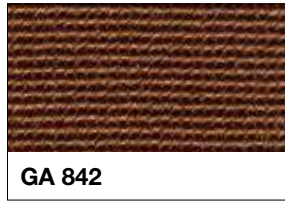
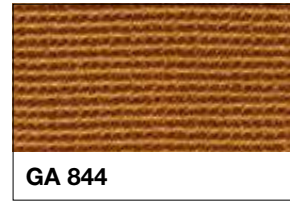
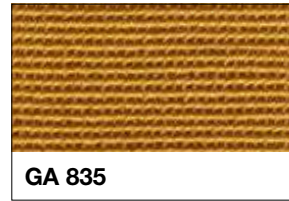
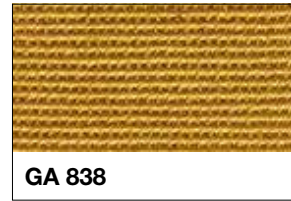
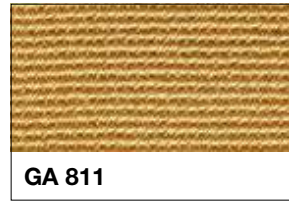
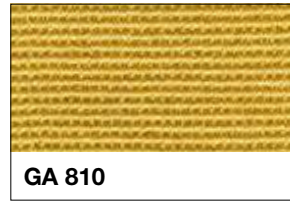
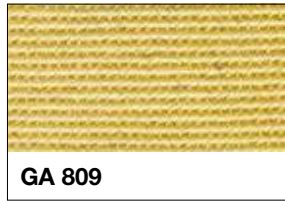
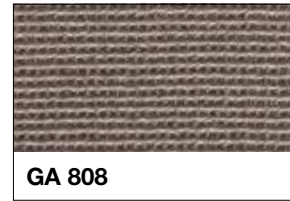
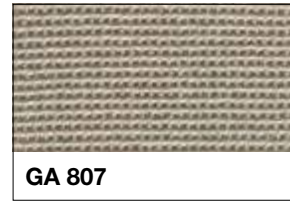
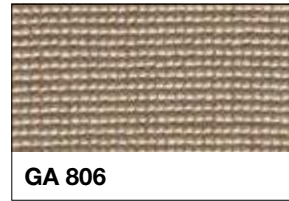
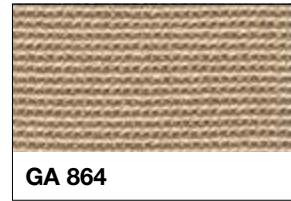
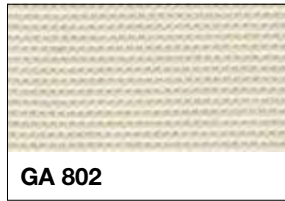

PIPING



GA 831



GA 818



GA 852



GA 853

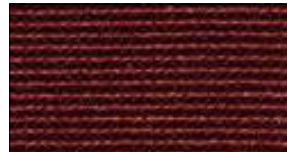

GA 849

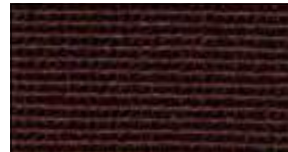

GA 850



GA 851



GA 854

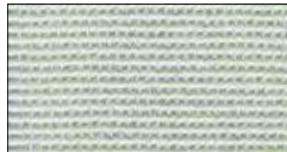

GA 860



GA 858



GA 859



GA 823



GA 861

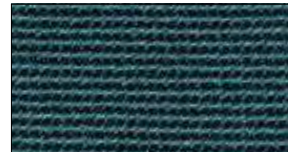

GA 824



GA 825



GA 826



GA 862



GA 827



GA 805



GA 847



GA 846



GA 848



GA 834



## PIPING



GA 831



GA 818



GA 852



GA 853



GA 849

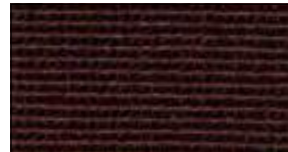

GA 850

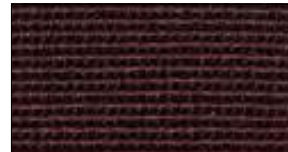

GA 851



GA 854

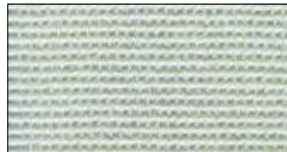

GA 860



GA 858



GA 859



GA 823

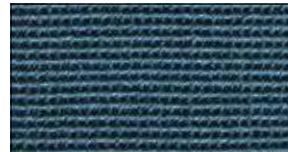

GA 861

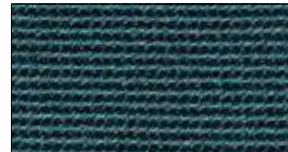

GA 824



GA 825



GA 826



GA 862



GA 827



GA 805



GA 847



GA 846



GA 848



GA 834





## GENERAL SALE AND DELIVERY CONDITIONS

### 1. ACCEPTANCE

The filing of a purchase order with GALIMBERTI NINO & C SNC implies the automatic and unconditional acceptance of these general sales conditions. Our confirmation is valid for finalization and acceptance of the order.

### 2. DELIVERY TERMS

The delivery terms indicated in the order confirmations are approximate, No penalties or responsibilities due to delayed delivery will be accepted.

### 3. PACKING AND DELIVERY

All the items are packed in cardboards. The type of the packaging is selected in terms of the nature of the goods, the weight and the dimensions of every single piece. Whenever clients opt for pallet packaging or wooden crates packaging, the cost will be surcharged. The number of packages and their condition must be carefully checked by the receiver. Any shortage or damage has to be notified to the forwarding agent or courier, immediately and before the receipt of the goods. In case of the above-mentioned shortage or damage, the transport company shall be held responsible.

### 4. COMPLAINTS

Any kind of complaint must be made within 8 (eight) days from the receipt of the goods. The complaints must be detailed, precise and always accompanied by photographs of both goods and packaging. All responsibility is declined for any type of covering and upholstery with the customer's material. Packages containing marble and crystal must be opened at the time of delivery, and any damage must be immediately notified and specified on the consignment note, countersigned by the carrier.

### 5. RETURNS

The return of the goods will not be accepted unless expressly authorised in writing. The returned goods must be delivered to our warehouse at the customer's expenses. The amount of possible credit will be agreed upon each time.

### 6. CUSTOMER OWN MATERIAL

Fabrics and leathers supplied by the customers must arrive free of any charge for GALIMBERTI NINO & C. SNC, otherwise they will be refused. The fabric requirement which is indicated in this price list, refers to plain fabrics of height 140 cm. For other kind of fabric or velvet, the necessary quantity must be requested every time to our offices.

### 7. COMBINATIONS OF FABRICS

If the requested covering is to be made with coordinated fabrics of different categories, the price of the higher category will be applied.

### 8. MEASUREMENTS AND CHARACTERISTICS OF THE PRODUCTS

The measurements indicated in our catalogues and price lists are in cm and concern the total encumbrance of the item, including any protuberance. Minimum variations in size in respect to indicated dimensions are possible. GALIMBERTI NINO & C. SNC reserves the right to make aesthetic technical or constructive variations without previous warning in order to improve the product.

### 9. FABRICS AND LEATHER

Fabrics and leather in our catalogue of samples are to be considered as samples of the quality and are indicative regarding colour. As it is not technically possible to guarantee the same tonality in time, GALIMBERTI NINO & C. SNC cannot be held responsible for possible tone differences in comparison with the sample or colour differences among products made in different periods. Possible natural imperfections which may be noticed on the surface of the leather are in fact the characteristics and the virtue of "full grain workmanship" and guarantees the authenticity of the leather.

### 10. WOOD AND FINISHING

Wood is a natural material in which variations in colour and grain structure are inevitable. The original colour will vary with time and exposition to sunlight. The finishing samples are indicative regarding the colour GALIMBERTI NINO & C, SNC cannot be held responsible for possible tone differences in comparison with the sample or colour differences among products made in different periods.

### 11. CUSTOMISED MEASUREMENTS

Any order for products with special dimensions are subject to evaluation by GALIMBERTI NINO & C. SNC. For any such orders that are accepted, GALIMBERTI NINO & C SNC will establish the surcharge and delivery terms, according to the adjustments to be made to the product.

### 12. LAW COURTS

For any controversy, which may arise between the parts, the Como law courts will have exclusive competence.

# NUOVO CLASSICO MILANESE

**Concept:** *partners.co.it*

**Photo:** Mauro Casagrande - *Studio Eleven*

**Designers:** Arch. Ilenia Viscardi - *ileniaviscardi.it* / Carlo Galimberti / Luciano Galimberti

**Stylist:** Roberta Galimberti

## **A SPECIAL THANKS TO**

**Art curator:** Emanuela Genovese - DOMUS ART VEDANO / *soleasrl.net*

**Art:** Nadiaanna Crosignani - *nacweb.it* / Francesca Provetti - *francescaprovettiart.it* / Arte è Kaos - *arteekaos.com*

**Accessories:** *bergomiinteriors.com*

**Lighting:** *italamp.com*

**Wallpapers:** *fromental.co.uk*

## **GALIMBERTI NINO & C. SNC**

via Milano 11  
22060 Cabiata (CO) - Italy  
Tel: +39 031 766515

info@galimberti.it  
galimberti.it

## Galimberti Nino

via Milano 11 / 22060 Cabiato (CO) - Italy / Tel: +39 031 766515 / [info@galimberti.it](mailto:info@galimberti.it)

**[galimberti.it](http://galimberti.it)**