

DANIEL
RUBINETTERIE
MILANO



2023

**DESIGN
COLLECTION**

DANIEL
RUBINETTERIE

MILANO

ANIMA E DESIGN - SOUL & DESIGN



AMBITION
pag 34



TRILOGY
pag 52



TIARA
pag 68



TOKYO
pag 86



SKYLINE
pag 102



FUSION
pag 120



DIVA
pag 136



SPEED
pag 150



SWING
pag 164



JAX
pag 178

STEEL COLLECTION



TOKYO STEEL
pag 190



WELLNESS STEEL
pag 198



ACCESSORIES STEEL
pag 212



KITCHEN STEEL
pag 216

CONTEMPORARY



REFLEX
pag 222



OMEGA
pag 238



SMART
pag 254



OMEGA GREEN
pag 272



SMART GREEN
pag 280

CLASSICA



BROOKLYN
pag 288



REVIVAL
pag 300



RETRÒ
pag 312



CRYSTAL RETRÒ
pag 322

WATERFALL & COLOR



CUBE WATERFALL
pag 334



CEILING COLUMNS
pag 342



SENSOR
pag 350



TEMPOR TOUCH
pag 360



TEMPOR
pag 364

PUBLIC & COMMERCIAL

WELLNESS



BOX INCASSO
BUILT-IN BOX
pag 372



KIT WELLNESS
WELLNESS KIT
pag 382



CROMOTERAPIA
COLOURTHERAPY
pag 396



SOFFIONI A SOFFITTO
CEILING SHOWER
HEADS
pag 410



SOFFIONI
SHOWER HEADS
pag 422



BOCCH
SPOUTS
pag 434



PANNELLI DOCCIA
SHOWER PANELS
pag 440



COLONNE DOCCIA
SHOWER COLUMNS
pag 446



SALISCENDI
SLIDING RAILS
pag 460



DOCCETTE
HAND SHOWERS
pag 466



OASIS
SHUT-OFF
pag 480



OUTDOOR
pag 490

THERMOSTATICS



X-FACTOR
pag 496



Q-FACTOR
pag 508



LAVELLI - SINKS



ACQUA DEPURATA
PURIFIED WATER
pag 518



ESTRAIBILI
PULL-OUT
pag 526



DESIGN
pag 532



GOURMET
pag 540



TOUCH-ME
pag 552



CONTEMPORARY
pag 556

COMPLEMENTI - COMPLEMENTS



VOGUE
pag 562



WIRE
pag 564



HILTON
pag 566



REVIVAL
pag 568



ACCESSORI BAGNO
BATH ACCESSORIES
pag 570



SISTEMA WC
WC SYSTEM
pag 574



SIFONI
TRAPS
pag 576



PILETTE
DRAIN
pag 580



RUBINETTI
SOTTOLAVABO
ANGLE VALVES
pag 584



RICAMBI
SPARE PARTS
pag 588



CROMO *CHROME*

FIN A



15

Nero Opaco
Matt Black



14

Bianco Opaco
Matt White



NP

Nichel Spazzolato
Brushed Nickel



XV

Visual Inox
Visual Steel



63

Vecchio Ottone
Old Brass



64

Vecchio Rame
Old Copper



OM

Vecchio Ottone Opaco
Matt Old Brass



SM

Ottone San Marco
S.Marco Brass



OIL

Oil Bronze
Oil Bronze



INOX *STEEL*

PVD

SS

PVD SOLO PER INOX
FOR STEEL ONLY



SS1

Nero Spazzolato PVD
Brushed Black PVD



SS2

Ottone Spazzolato PVD
Brushed Brass PVD



SS3

Rame Spazzolato PVD
Brushed Copper PVD

FIN B



DO

Oro Lucido
Shiny Gold



DP

Oro Spazzolato
Brushed Gold

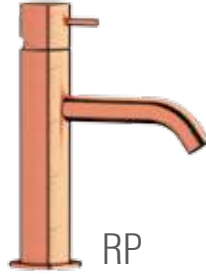

RP

Rame Spazzolato Lucido
Shiny Brushed Copper



CF

Cromo Nero Lucido
Shiny Black Chrome



FZ

Cromo Nero Spazzolato Lucido
Shiny Brushed Black Chrome

BICOLOR SOLO PER FUSION FOR FUSION ONLY



14LEDO

Oro Lucido / Bianco Opaco
Shiny Gold / Matt White



15LEDP

Oro Spazzolato / Nero Opaco
Brushed Gold / Matt Black



RPLE15

Nero Opaco / Rame Spazzolato
Matt Black / Brushed Copper



DOLE15

Nero Opaco / Oro Lucido
Matt Black / Shiny Gold

OPZIONI DI FINITURA

Tutte le nostre collezioni di rubinetteria in **ottone** possono essere personalizzate con tutti i colori di finitura dei gruppi FIN A e FIN B.

La collezione **FUSION** può in aggiunta essere realizzata secondo le opzioni di finitura del gruppo BICOLOR.

Gli articoli della **COLLEZIONE STEEL** sono disponibili SOLO nei colori del gruppo PVD.

FINISHING OPTIONS

All our **brass** faucet collections can be customized with the all the finishing colours from FIN A and FIN B groups.

FUSION collection can additionally be made with the finishing options of BICOLOR group.

STEEL COLLECTION items are available in PVD colours ONLY.

Choose

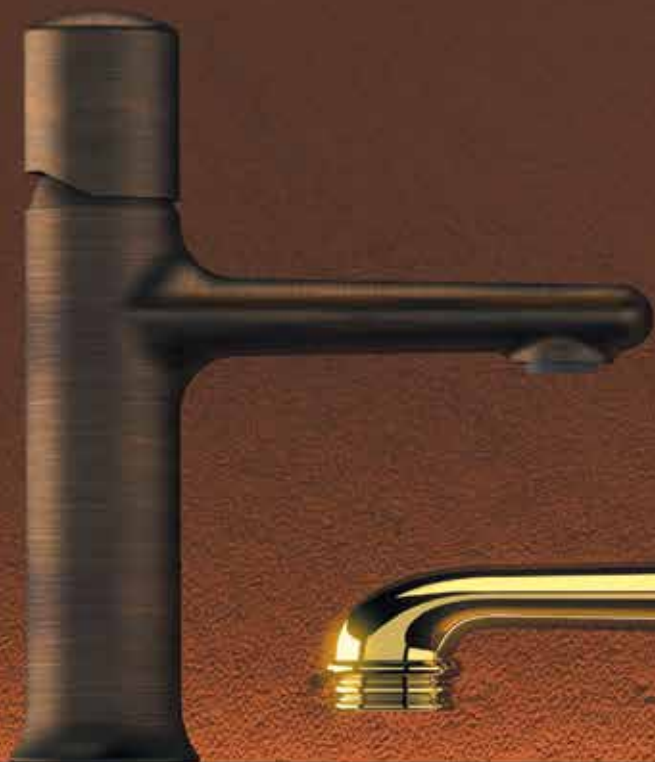

*Your
Style*





GOLD
STYLE



BLACK
STYLE



OIL
STYLE



WHITE
STYLE

DEKORA DESIGN

Creazioni d'arredo

La tecnica DEKORA DESIGN di Daniel Rubinetterie propone una personalizzazione stilistica della rubinetteria attraverso esclusivi temi decorativi.

Abbinando due diverse finiture si crea un contrasto cromatico che dà vita alla decorazione, con un effetto più delicato negli abbinamenti tono su tono o più evidente nelle combinazioni che includono Cromo Nero Lucido. DEKORA DESIGN è disponibile con il decoro ELEGANCE in 4 diverse combinazioni su tutti gli articoli della collezione SPEED.

Creative decor

The DEKORA DESIGN technique by Daniel Rubinetterie offers a stylistic customization of the faucets through exclusive decorative themes.

The combination of two different finishes creates a chromatic contrast that gives life to the decoration, with a more delicate effect in the tone-on-tone matchings or a more evident result in combinations with Black Chrome. DEKORA DESIGN is available with the ELEGANCE decoration in 4 different finishing combinations for all the items in the SPEED collection.



YE97

Base Nichel Spazzolato / Decoro Nichel Lucido
Brushed Nickel base / Shiny Nickel decor



YE3A

Base Nichel Spazzolato / Decoro Cromo Nero Lucido
Brushed Nickel base / Shiny Black Chrome decor



YE6A

Base Oro Spazzolato / Decoro Oro Lucido
Brushed Gold base / Shiny Gold decor



YE4A

Base Oro Spazzolato / Decoro Cromo Nero Lucido
Brushed Gold base / Shiny Black Chrome decor

SPEED
ELEGANCE



SPEED
ELEGANCE

DEKORA **SENSE** DESIGN

Gioielli d'arredo

DEKORA SENSE è una finitura a rilievo per un risultato finale estremamente elegante, moderno e delicato: la decorazione acquista spessore e diventa parte viva del design del miscelatore, fondendosi in esso.

L'effetto a rilievo è plasmato nella forma e ben visibile; esso stupisce per innovazione e per la delicatezza con cui si presenta. DEKORA SENSE è disponibile nei colori Bianco Opaco e Nero Opaco, dedicata agli articoli della collezione SPEED in abbinamento al decoro ELEGANCE.

Interior jewelry

DEKORA SENSE is a low-relief finish and its resulting effect is elegant, modern and soft: an embedded decoration that enhances the design of the tap accentuating the depth and melting into it.

The relief effect is moulded into the shape and clearly visible, amazing for its innovation and delicacy DEKORA SENSE is available in Matt White and Matt Black colours, dedicated to SPEED collection items in combination with the ELEGANCE decoration.

SPEED
SENSE



YE14

Bianco Opaco
Matt White



YE15

Nero Opaco
Matt Black



SPEED
SENSE

DEKORA YOU AND ME

Scritte decorative

Con l'opzione DEKORA YOU AND ME si possono personalizzare i miscelatori per lavabo delle collezioni SKYLINE e TOKYO con una scritta a propria scelta. Che sia il vostro nome, un soprannome affettuoso per i membri della famiglia o una parola che vi rappresenta, il risultato sarà sempre unico e scenografico.

Ogni parola deve essere di **massimo 6 caratteri** che saranno distribuiti sulla base frontale del miscelatore. Il font utilizzato è solo in stampatello e nello stile riportato qui sotto.

Potrete avere una resa tono su tono scegliendo un decoro che abbinia lo stesso colore nelle versioni lucida e spazzolata, oppure una resa più contrastata scegliendo un decoro con il cromo nero lucido che evidenzia al meglio la scritta. In entrambi i casi il risultato sarà molto scenografico.

La proposta YOU AND ME è dedicata a due modelli di miscelatori per lavabo SKYLINE e a due modelli di miscelatori per lavabo TOKYO (versione con e senza scarico) in quanto si presuppone che vengano installati sopra-piano, senza che una bacinella copra la scritta.

Decor lettering

Using YOU AND ME DEKORA option, the washbasin mixers from SKYLINE and TOKYO collections can be customized with a text of Your choice. Whether it's Your name, a loving nickname for the family members or a word that represents you, the result will always be unique and spectacular.

*Each word must have a **maximum of 6 characters** which will be distributed on the front base of the mixer. The font used is in uppercase only and in the style shown here below.*

You can have a tone-on-tone result by choosing a decoration that combines the same color in the shiny and brushed versions, or a more contrasted result by choosing a decoration with shiny black chrome that best highlights the writing. In both cases the result will be very spectacular.

The YOU AND ME proposal is dedicated to two models of SKYLINE washbasin mixers and two models of TOKYO washbasin mixers (with and without waste) as it is assumed that they are installed above the top, without a basin covering the writing.

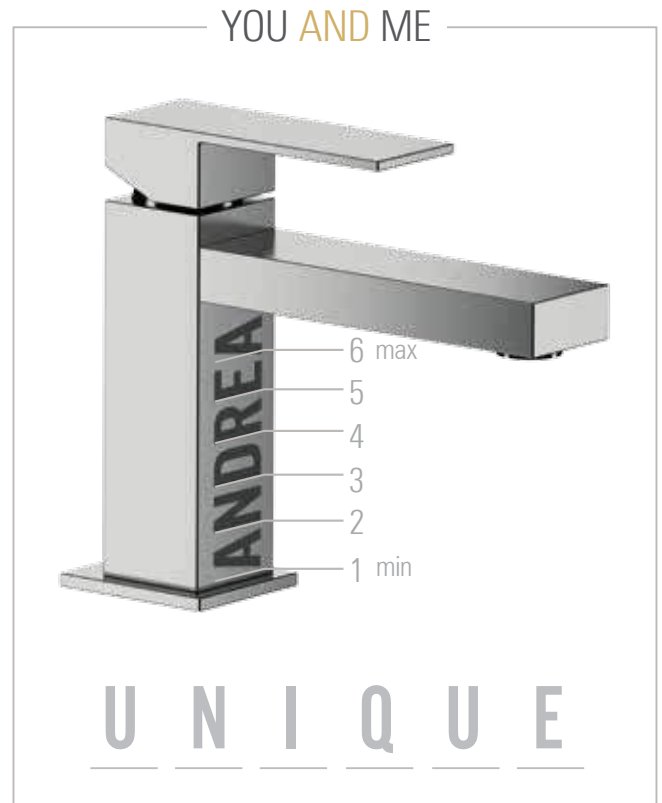

A B C D E F G H I J K L M N O P Q R S T U V W X Y Z

TOKYO
YOU AND ME

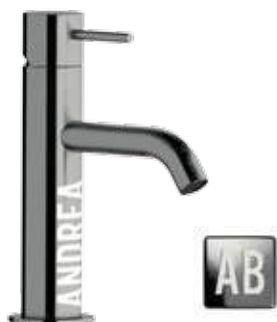

YX97

Base Nichel Spazzolato / Decoro Nichel Lucido
Brushed Nickel base / Shiny Nickel decor



YX3A

Base Nichel Spazzolato / Decoro Cromo Nero Lucido
Brushed Nickel base / Shiny Black Chrome decor



YX6A

Base Oro Spazzolato / Decoro Oro Lucido
Brushed Gold base / Shiny Gold decor



YX4A

Base Oro Spazzolato / Decoro Cromo Nero Lucido
Brushed Gold base / Shiny Black Chrome decor



YX97

Base Nichel Spazzolato / Decoro Nichel Lucido
Brushed Nickel base / Shiny Nickel decor



YX3A

Base Nichel Spazzolato / Decoro Cromo Nero Lucido
Brushed Nickel base / Shiny Black Chrome decor

SKYLINE
YOU AND ME



YX6A

Base Oro Spazzolato / Decoro Oro Lucido
Brushed Gold base / Shiny Gold decor



YX4A

Base Oro Spazzolato / Decoro Cromo Nero Lucido
Brushed Gold base / Shiny Black Chrome decor

YOU AND ME A B C D E F



G H I J K L M N O P Q R S T U V W X Y Z



EXPRESS YOURSELF

YOU AND ME A B C D E F

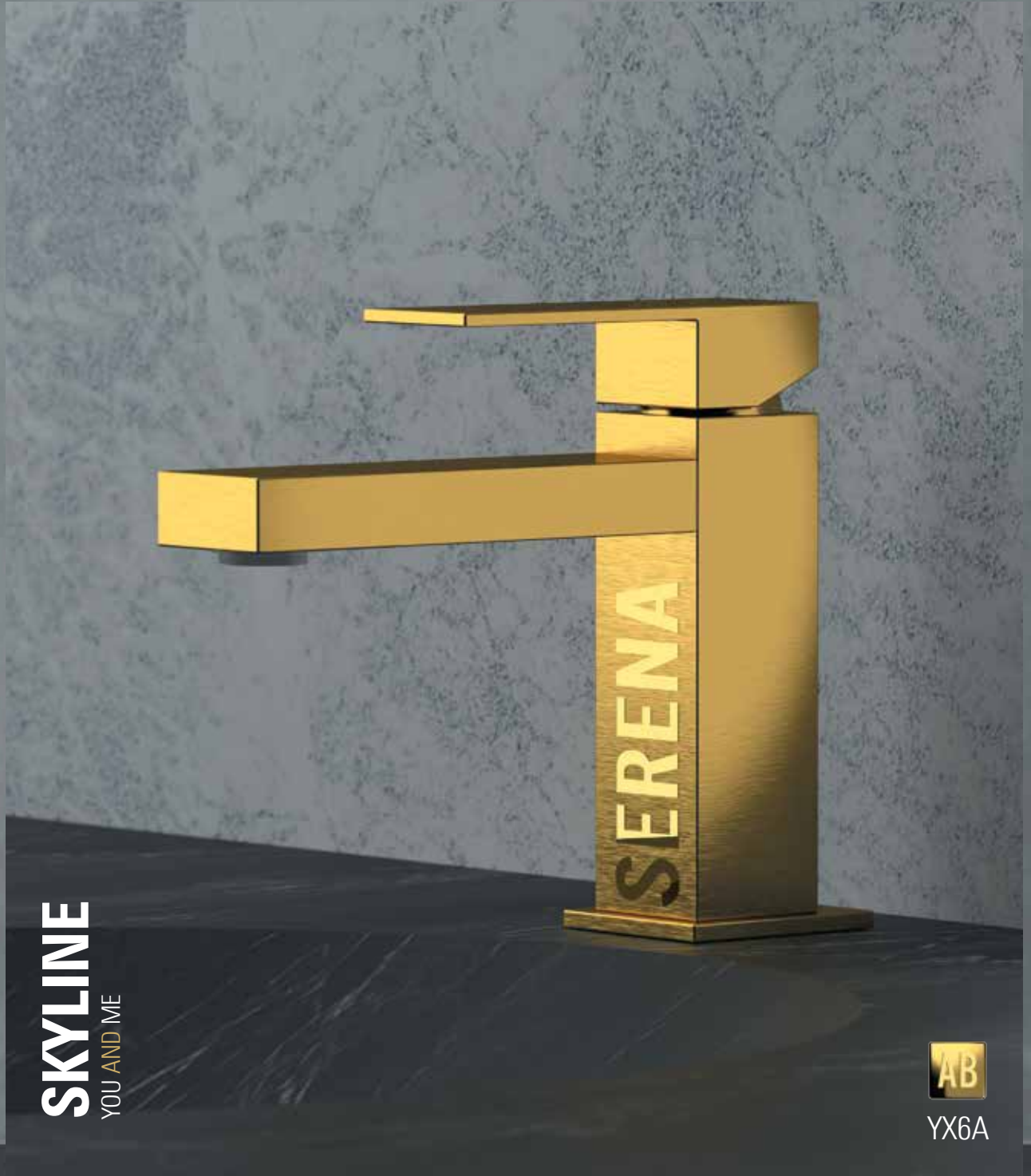

SKYLINE
YOU AND ME



YX6A

G H I J K L M N O P Q R S T U V W X Y Z



TOKYO
YOU AND ME



YX3A

DANIEL DEKORA

DANIEL RUBINETTERIE

Creativi dal 1985

Nata nel 1985, Daniel Rubinetterie è un'azienda produttrice di rubinetteria creativa. Sinonimo di ricercatezza e alta tecnologia produttiva, Daniel Rubinetterie si impegna a diffondere e a confermare il valore della qualità "Made in Italy" in Italia e nel mondo.

Dai suoi stabilimenti in provincia di Milano, Daniel ha rivoluzionato l'approccio classico alla rubinetteria, ideando tecniche decorative brevettate e puntando sull'originalità delle creazioni. L'obiettivo di Daniel è offrire un prodotto estremamente personalizzabile, che possa adattarsi alle specifiche esigenze del Cliente e farsi pura espressione del gusto personale. La rubinetteria assume così un incarico esclusivo nel progetto di arredo, certa di soddisfare pienamente i gusti e le richieste di una Clientela sempre attenta alla qualità del prodotto e con un forte desiderio di differenziarsi.

Chi sceglie Daniel Rubinetterie è un consumatore esigente che cerca soluzioni innovative e richiede elevati standard qualitativi per un duraturo funzionamento nel tempo.

Da oltre 30 anni Daniel Rubinetterie soddisfa questo mercato fornendo un attento servizio di consulenza, scegliendo con grande cura i migliori materiali, utilizzando le tecniche di produzione e di montaggio più moderne ed eseguendo dei minuziosi collaudi sui prodotti.

Creative since 1985

Started in 1985, Daniel Rubinetterie is a manufacturer of creative faucets. Synonymous with elegance and high technology production, Daniel Rubinetterie, Daniel Rubinetterie is committed to promoting and confirming the value of "Made in Italy" quality in Italy and around the world.

From its factories in Milan province, Daniel changes the classic approach to faucets, designing patented and decorative techniques and focusing on original creations. Daniel Rubinetterie aims to offer a highly customizable product to satisfy the specific needs of each Customer and to make the faucet a pure expression of every personal taste. Faucets thus take an exclusive assignment in the furniture project, sure to fully satisfy tastes and needs of those Customers attentive to product quality and with a strong desire to stand out.

Those who choose Daniel Rubinetterie are demanding consumers looking for innovative solutions and requiring high quality standards for long-lasting operation. For over 30 years, Daniel Rubinetterie has been satisfying this market by providing an attentive consultancy service, choosing the best materials with great care, using the most modern production and assembly techniques and carrying out meticulous tests on the products.

Produzione flessibili
*Flexible hoses
production.*

ENGINEERING 1
Produzione high-tech
High-tech production

ENGINEERING 2
Produzione high-tech
High-tech production

Pulitura, Controllo qualità,
Pre-assemblaggio.
*Polishing department,
Test department,
Pre-assembly
department, Injection.*

Sede operativa e uffici
amministrativi
Head office and factory.



DANIEL
RUBINETTERIE
MILANO

Cassano d'Adda (MI) - Italy
Lat: 45° 31' 37" N Long: 9° 30' 11" E

Ideare ed innovare

I prodotti Daniel Rubinetterie nascono all'interno del nostro Dipartimento di Design che progetta le collezioni seguendo ispirazioni creative in continua evoluzione e curando tutti i dettagli estetici.

Il Dipartimento interno di Ricerca e Sviluppo si occupa poi di completare il progetto, valutando le combinazioni di materiali e tecnologie più adatte, definendo le soluzioni migliori in termini di estetica e di funzionalità. La collaborazione con l'azienda italiana S.T.S.R. supporta inoltre la creazione di proposte di rubinetteria con tecnologia integrata: bocche e miscelatori con luce LED, miscelatori cucina con tecnologia TOUCH-ME, rubinetteria con sensore infrarossi e temporizzazione elettronica ad alta precisione.

Il risultato è una ricca gamma prodotti innovativa e funzionale, caratterizzata da un design esclusivo e capace di accontentare le differenti esigenze di stile delle ambientazioni sia moderne che tradizionali.

Design and innovation

Daniel Rubinetterie products come to life within our Design Department which designs the collections following creative inspirations in continuous evolution and taking care of all the aesthetic details.

The internal Research and Development Department then takes care of completing the project, evaluating the most suitable combinations of materials and technologies, defining the best solutions in terms of aesthetics and functionality. The collaboration with the Italian Company S.T.S.R. also supports the creation of faucets with integrated technology: mixers and spouts with LED light, kitchen mixers with TOUCH-ME technology, infrared sensor taps and high-precision electronic timed flow taps.

The result is a rich range of innovative and functional products, characterized by an exclusive design and capable of satisfying the different style requirements of both modern and traditional settings.





Realizzare

Gli stabilimenti produttivi di Daniel Rubinetterie si trovano a Cassano D'Adda in provincia di Milano (Italia). Un parco macchine di ultima generazione permette di automatizzare la maggior parte delle le fasi di lavorazione che portano dalla creazione del prototipo alla realizzazione del prodotto finito, testato e confezionato. Grazie alla precisione dei singoli passaggi produttivi possiamo dedicare grande attenzione anche ai più piccoli dettagli, arrivando ad un prodotto finito di alta qualità.

Manufacturing

Daniel Rubinetterie's production plants are located in Cassano D'Adda in the province of Milan (Italy). A fleet of latest generation machines performs most of the processing phases that lead from the prototype creation to a finished, tested and packaged product. Thanks to the precision of each production step, we can devote more attention to smallest details, resulting in a high quality finished product.

Rispettare

Daniel Rubinetterie produce dove vive e lo fa nel pieno rispetto dell'ambiente.

L'azienda è certificata sia a livello nazionale (UNI) che europeo dall'ente tedesco TÜV Thüringen secondo gli standard ISO 9001, sistema di qualità aziendale. La produzione interna agli stabilimenti del Gruppo permette inoltre di pianificare e seguire con attenzione ogni passaggio del ciclo produttivo, ottimizzando le risorse, limitando gli sprechi e garantendo la massima efficienza.

Respecting

Daniel Rubinetterie produces where he lives and does it fully respecting of the environment.

The company is certified at both national (UNI) and European level by the German body TÜV Thüringen according to standards ISO 9001, quality management system. A production cycle closed within the Group factories also allows to schedule and carefully follow each production step, optimizing resources, reducing waste and ensuring the maximum efficiency.

Personalizzare

La principale missione di Daniel Rubinetterie è offrire ai propri di Clienti la possibilità di personalizzare con stile e creatività gli ambienti di bagno e cucina.

Ogni collezione di rubinetteria a catalogo viene infatti corredata da un'ampia scelta di finiture e decori che consentono innumerevoli combinazioni di stili e colori. Le tecniche decorative brevettate DEKORA e DEKORA SENSE aprono inoltre un nuovo mondo di possibilità esclusive e aggiungono un prezioso potenziale creativo alle collezioni di rubinetteria Daniel.

Tutte le finiture sono eseguite su specifica richiesta e possono essere commissionate anche su un solo articolo. In questo modo ogni Cliente è pienamente libero di esprimere la propria individualità, rendendo unico e prestigioso ogni progetto di arredo.

Customization

Daniel Rubinetterie's main mission is to offer its customers the opportunity to customize bathroom and kitchen interiors with style and creativity.

Each faucet collection in the catalog is in fact available with a wide choice of finishing options and decorations for a countless combinations of styles and colors. The patented decorative techniques DEKORA and DEKORA SENSE also add a whole new world of unique possibilities and enhance the creative potential of Daniel faucet collections.

All the finishing options are made on demand and can also be requested for a single item. In this way, Customers are fully free to express their own individuality, making unique and prestigious each home interior.

*Black
and
Gold*



FAUCETS FOR INTERIOR DESIGN

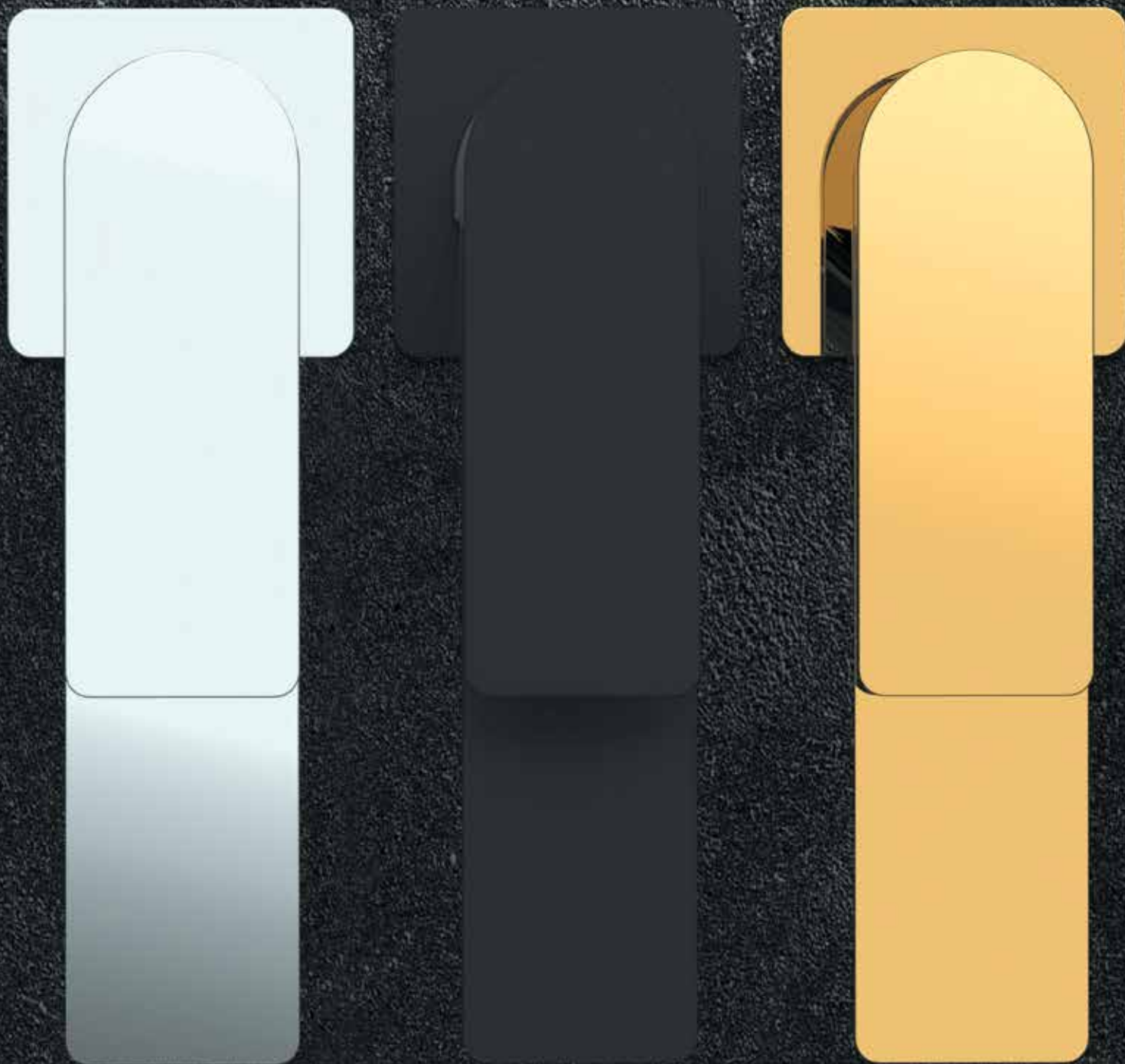

DANIEL
RUBINETTERIE
MILANO

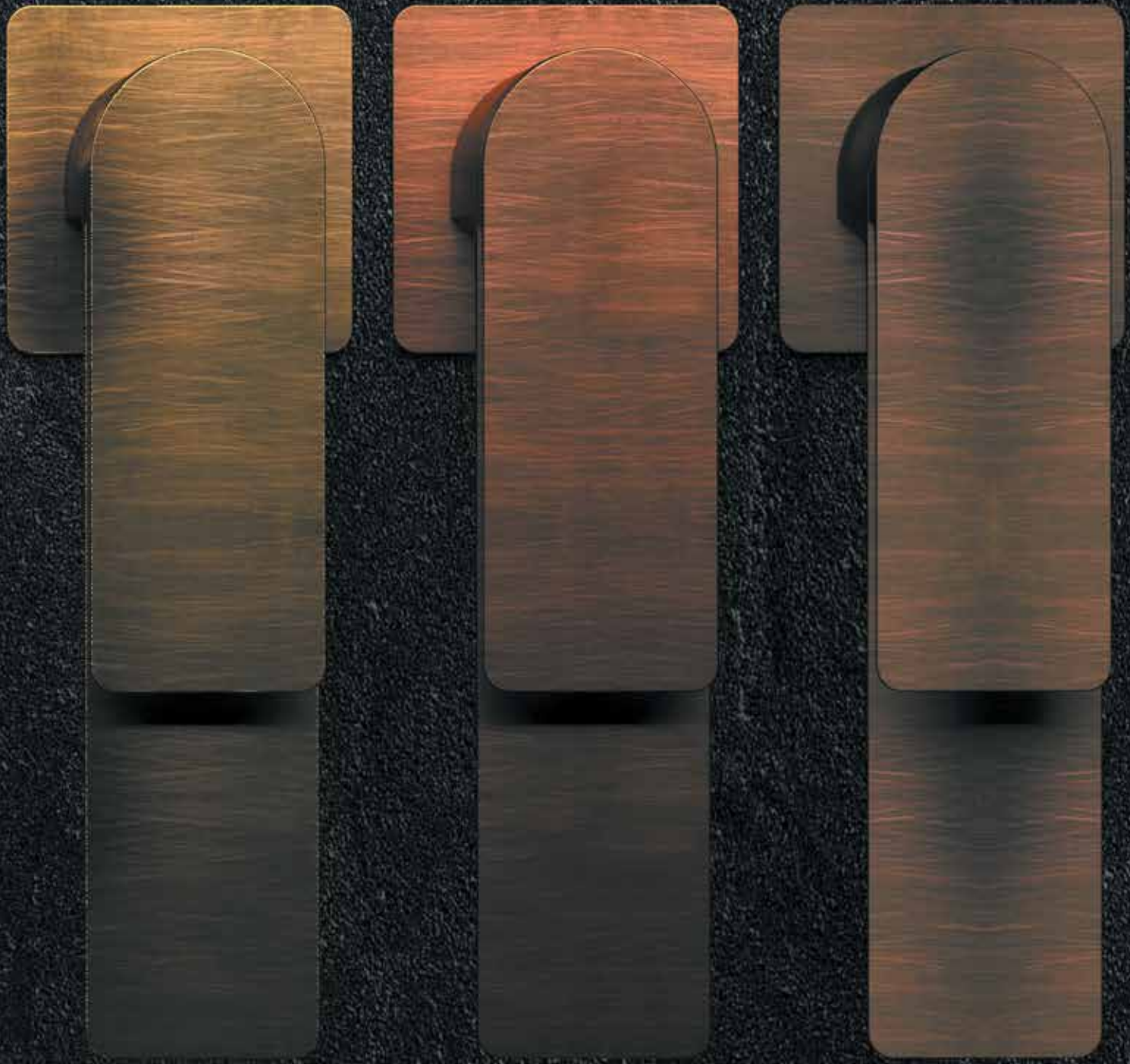

RUBINETTERIE PER L'INTERIOR DESIGN



ANIMA E DESIGN
SOUL & DESIGN



FU606

AMBITION	pag 34
TRILOGY	pag 52
TIARA	pag 68
TOKYO	pag 86
SKYLINE	pag 102
FUSION	pag 120
DIVA	pag 136
SPEED	pag 150
SWING	pag 164
JAX	pag 178



Ambition

AMBITION



AMBITION



AI632P



AI606N



AI604BN

La collezione AMBITION esprime un'eleganza moderna e sofisticata, impreziosita da dettagli tecnici che la rendono unica nel suo genere. L'assenza dei tagli posteriori sulla leva accentua e perfeziona il parallelismo con la bocca nei miscelatori per lavabo. L'aeratore che scompare totalmente all'interno della forma in ottone garantisce l'equilibrio dell'intero design anche nelle versioni in finitura.

CARATTERISTICHE TECNICHE:

La serie è dotata di cartuccia a dischi ceramici Ø 25m per i miscelatori d'appoggio, Ø 35 per gli incassi. Cartucce prodotte da S.T.S.R. - Studio Tecnico Sviluppo e Ricerche - www.stsr.it

The AMBITION collection expresses a modern and sophisticated elegance, enhanced by technical details that make it unique in its kind. The absence of rear cuts on the lever accentuates and perfects the parallelism with the spout in washbasin mixers. The aerator that completely disappears inside the brass shape guarantees the balance of the entire design even in the finished versions.

TECHNICAL FEATURES:

The series is equipped with a Ø 25m ceramic disc cartridge for the countertop mixers, Ø 35 for the built-in items. Cartridges produced by S.T.S.R. - Development and Research Technical Study - www.stsr.it



A1607

AMBITION

TRILOGY

TIARA

TOKYO

SKYLINE

FUSION

DIVA

SPEED

SWING

JAX



OIL
OIL BRONZE
OIL BRONZE

15
NERO OPACO
MATT BLACK

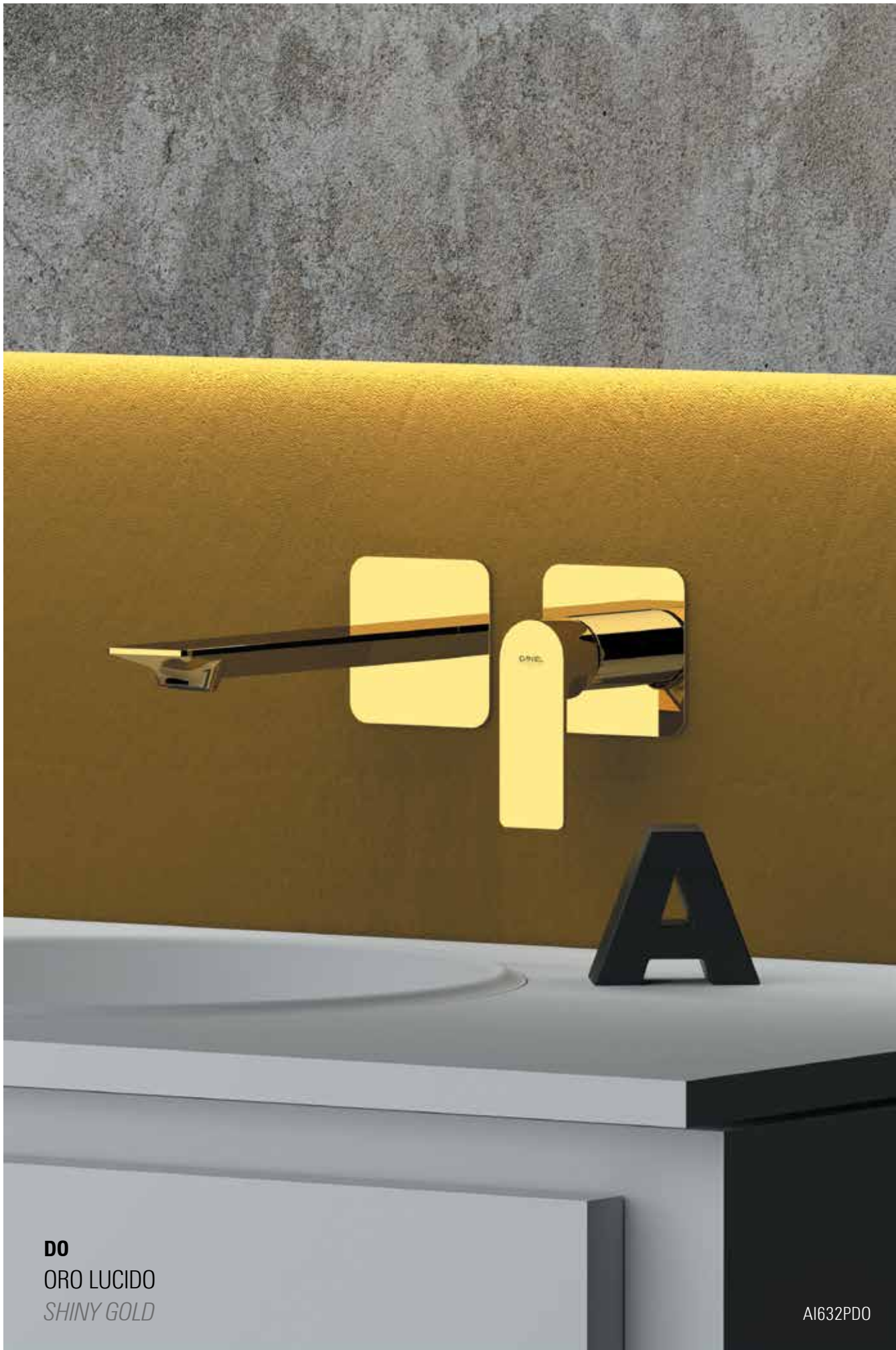

DO
ORO LUCIDO
SHINY GOLD

AI632PDO

AMBITION

TRILOGY

TIARA

TOKYO

SKYLINE

FUSION

DIVA

SPEED

SWING

JAX

LAVABI - WASHBASIN MIXERS



AI605

Monocomando lavabo, con scarico.
Single-lever basin mixer, with pop-up waste.



AI606N

Monocomando lavabo, senza scarico e senza foro sul corpo.
Single-lever basin mixer, without waste and without body hole.



AI607

Monocomando lavabo XL., con scarico click-clak con troppo pieno.
XL basin mixer, with pop-up waste, with over flow.



AI655

Miscelatore monocomando lavabo due fori.
Scarico non incluso.
Two holes single-lever washbasin mixer.
Waste not included.

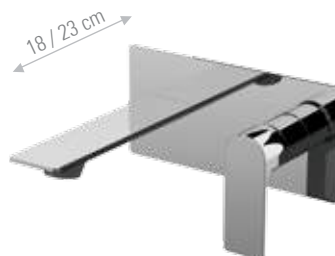
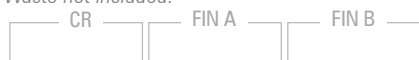

AI632

Miscelatore monocomando a incasso per lavabo, con piastra rettangolare.
Lunghezza bocca: 18 cm.
Single-lever built-in basin mixer, with rectangular wall flange. Spout length: 18 cm.

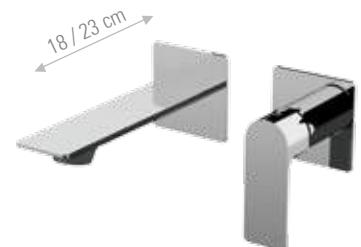

AI632P

Miscelatore monocomando da incasso per lavabo, su doppia piastra.
Lunghezza bocca: 18 cm.
Built-in single-lever basin mixer with two separate plates. Spout length: 18 cm.



AI655L

Miscelatore monocomando lavabo due fori, con bocca L. Scarico non incluso.
Two holes single-lever washbasin mixer, with L spout. Waste not included.

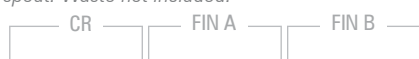

AI632L

Miscelatore monocomando a incasso per lavabo, con piastra rettangolare.
Lunghezza bocca: 23 cm.
Single-lever built-in basin mixer, with rectangular wall flange. Spout length: 23 cm.



AI632PL

Miscelatore monocomando da incasso per lavabo, su doppia piastra.
Lunghezza bocca: 23 cm.
Built-in single-lever basin mixer with two separate plates. Spout length: 23 cm.



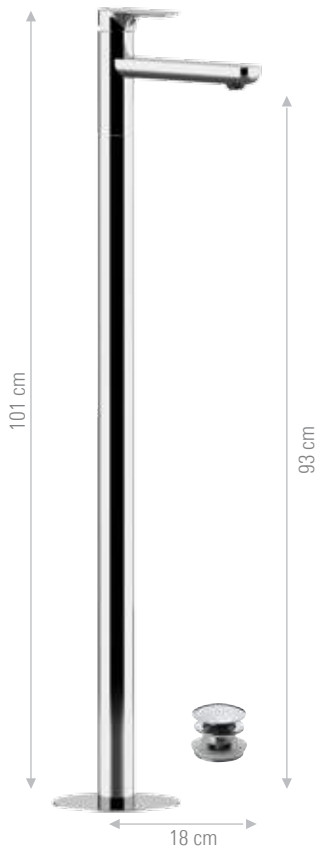

AI688

Miscelatore monocomando lavabo da pavimento con click-clack e troppo pieno.
Single-lever mixer floor mounting with click-clack and overflow.

CR	FIN A	FIN B
----	-------	-------

LAVABO BOX INCASSO BUILT-IN BOX WASHBASIN MIXER

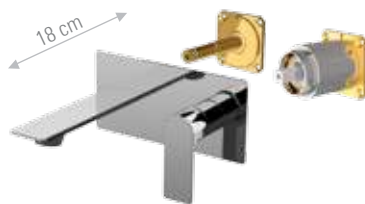

AI632KB

Miscelatore monocomando a incasso per lavabo, con piastra in ottone, lunghezza bocca 18 cm, da abbinare al box incasso.
Single-lever built-in basin mixer, with wall flange in brass, spout length 18 cm, to use with the built-in box.

CR	FIN A	FIN B
----	-------	-------



DANBOX632

Box incasso per miscelatore monocomando a incasso per lavabo.
Built-in box for single-lever built-in basin mixer.

CR

AI632LKB

Lunghezza bocca 23 cm.
Spout length 23 cm.

CR	FIN A	FIN B
----	-------	-------



AI604

Miscelatore bidet, con scarico.
Bidet mixer, with pop-up waste.

CR	FIN A	FIN B
----	-------	-------

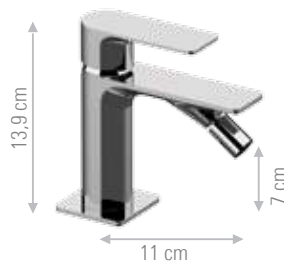

AI604BN

Miscelatore bidet, senza scarico e senza foro sul corpo.
Bidet mixer, without waste and without body hole.

CR	FIN A	FIN B
----	-------	-------

BIDET



AI645BP4DC

Miscelatore incasso per shut-off comprensivo di doccetta shut-off art. 1004DC, supporto doccia-presa acqua, tutto in ottone cromato e flessibile doccia cm 120 in acciaio inox.
Built-in shower mixer set including :shut-off art. 1004DC, shower holder-water punch on flange, all in c.p. brass and shower flexible cm 120 in stainless steel.

CR	FIN A	FIN B
----	-------	-------

BOCCHE - SPOUTS

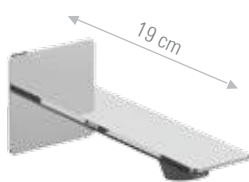

AI4704

Bocca incasso.
Built-in spout.

CR FIN A FIN B

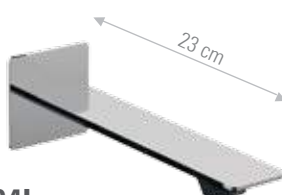

AI4704L

Bocca incasso.
Built-in spout.

CR FIN A FIN B

MISCELATORI VASCA E DOCCIA - SHOWER AND BATH MIXERS



AI6102

Miscelatore vasca esterno, con doccetta in ottone 1 funzione, flessibile 150 cm.
Exposed bath mixer, with 1-function brass hand shower, flexible 150 cm.

CR FIN A FIN B



AI631A2

Monocomando doccia esterno, con doccetta in ottone 1 funzione, flessibile 150 cm.
Exposed shower mixer, with 1-function brass hand shower, flexible 150 cm.

CR FIN A FIN B

AI600H

Miscelatore vasca esterno, senza kit doccia.
Exposed bath mixer, without shower kit.

CR FIN A FIN B

AI631

Monocomando doccia esterno, senza kit doccia.
Exposed shower mixer, without shower kit.

CR FIN A FIN B



AI610

Miscelatore vasca esterno, con doccetta in ABS 3 funzioni, flessibile 150 cm.
Exposed bath mixer, with 3-function ABS hand shower, flexible 150 cm.

CR 15



AI631A

Monocomando doccia esterno, con doccetta in ABS 3 funzioni, flessibile 150 cm.
Exposed shower mixer, with 3-function ABS hand shower, flexible 150 cm.

CR 15

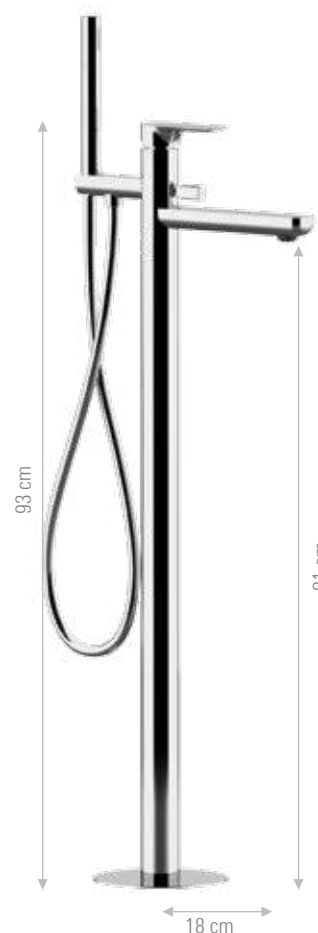

AI678

Miscelatore vasca da pavimento con deviatore e kit doccia in ottone ad 1 funzione.
Free standing bath mixer floor mounting with diverter and 1-function brass hand shower kit.

CR FIN A FIN B

□ □ □ 2 VIE - 2-WAY □ □ □



AI700D2

Set miscelatore a incasso a 2 vie per vasca/doccia su piastra unica rettangolare, include miscelatore monocomando, deviatore a 2 uscite, bocca a muro. Da completare con una seconda uscita acqua.

2-way built-in mixer set for bathtub / shower on single rectangular plate, including single-lever mixer, 2-way diverter, wall spout. To be completed with a second water outlet.

CR	FIN A	FIN B
----	-------	-------



AI700D2P

Set miscelatore a incasso a 2 vie per vasca/doccia su 3 piastre tonde separate (piastre separate e incasso unico), include: miscelatore monocomando, deviatore a 2 uscite, bocca a muro. Da completare con una seconda uscita.

2-way built-in mixer set for bathtub / shower on 3 separate round plates (separate plates, one single built-in part), including: single-lever mixer, 2-way diverter, wall spout. To be completed with a second water outlet.

CR	FIN A	FIN B
----	-------	-------



AI710D2

Set a incasso a 2 vie per vasca, include: miscelatore monocomando, deviatore a 2 uscite e bocca a muro su piastra unica rettangolare; set doccia su piastra quadrata con presa acqua, supporto integrato, doccetta in ottone e flessibile 150cm.

2-way built-in set for bathtub, including: single-lever mixer, 2-way diverter and wall spout on a single rectangular plate; shower set on square plate with water connection, holder, brass handshower and 150cm flexible hose.

CR	FIN A	FIN B
----	-------	-------



AI710D2P

Set a incasso a 2 vie per vasca su piastre tonde separate (3 piastre separate e incasso unico), include: miscelatore monocomando con deviatore a 2 uscite, bocca a muro; set doccia su piastra tonda con presa acqua, supporto, doccetta e flessibile 150cm.

2-way built-in set for bathtub on separate round plates (3 separate plates, one single built-in part), including: single-lever mixer, 2-way diverter, wall spout; Shower set on round plate with water connection, holder, hand shower and 150cm flexible hose.

CR	FIN A	FIN B
----	-------	-------

□ □ □ 3 VIE - 3-WAY □ □ □



AI700D3

Set miscelatore a incasso a 3 vie per vasca/doccia su piastra unica rettangolare, include miscelatore monocomando, deviatore a 3 uscite, bocca a muro. Da completare con una seconda e una terza uscita acqua.

3-way built-in mixer set for bathtub/shower on single rectangular plate, including single-lever mixer, 3-way diverter, wall spout. To be completed with second and third water outlets.

CR	FIN A	FIN B
----	-------	-------

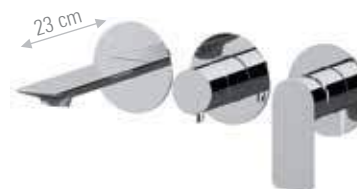

AI700D3P

Set miscelatore a incasso a 3 vie per vasca/doccia su 3 piastre tonde separate (piastre separate e parte a incasso unica), composto da: miscelatore monocomando con deviatore a 3 uscite, bocca a muro. Da completare con una seconda e una terza uscita acqua.

3-way built-in mixer set for bathtub/shower on 3 separate round plates (separate plates, one single built-in part), including: single-lever mixer with 3-way diverter, wall spout. To be completed with second and third water outlets.

CR	FIN A	FIN B
----	-------	-------

INCASSI DOCCIA - BUILT-IN MIXERS

□ □ □ 1 VIA - 1-WAY □ □ □



AI602G

Miscelatore incasso per doccia (articolo COMPLETO).
Built-in shower mixer (COMPLETE item).

CR FIN A FIN B

IN602C35

SOLO parti a incasso
Built-in parts ONLY.

CR FIN A FIN B

AI602GEKIT

SOLO parti esterne.
Exposed parts ONLY.

CR FIN A FIN B



AI602

Miscelatore incasso per doccia su piastra lusso ultrapiatta (articolo COMPLETO).
Built-in shower mixer on luxury ultraslim plate (COMPLETE item).

CR FIN A FIN B

IN602C35

SOLO parti a incasso
Built-in parts ONLY.

CR FIN A FIN B

AI602EKIT

SOLO parti esterne.
Exposed parts ONLY.

CR FIN A FIN B

□ □ □ 2 VIE - 2-WAY □ □ □



AI612G

Miscelatore incasso con deviatore per vasca/doccia (articolo COMPLETO).
Built-in bath/shower mixer with diverter (COMPLETE item).

CR FIN A FIN B

IN612C35

SOLO parti a incasso
Built-in parts ONLY.

CR FIN A FIN B

AI612GEKIT

SOLO parti esterne.
Exposed parts ONLY.

CR FIN A FIN B



AI612

Miscelatore incasso con deviatore per vasca/doccia su piastra lusso ultrapiatta (articolo COMPLETO).
Built-in bath/shower mixer with diverter on luxury ultraslim plate (COMPLETE item).

CR FIN A FIN B

IN612C35

SOLO parti a incasso
Built-in parts ONLY.

CR FIN A FIN B

AI612EKIT

SOLO parti esterne.
Exposed parts ONLY.

CR FIN A FIN B



AI612D2

Miscelatore incasso con deviatore a 2 vie per vasca/doccia su piastra lusso ultraslim (articolo COMPLETO).

Built-in bath/shower mixer with 2-way diverter on luxury ultraslim plate (COMPLETE item).

CR FIN A FIN B



AI712D2

Set miscelatore a incasso a 2 vie per doccia su piastra unica rettangolare, include presa acqua con supporto, doccetta e flessibile 150 cm.

Da completare con una 2° uscita.

2-way built-in shower mixer set on a single rectangular plate, including water connection with shower holder, hand shower and 150cm hose.

To be completed with a 2nd water outlet.

CR FIN A FIN B



AI712D2P

Set miscelatore a incasso a 2 vie per doccia su 3 piastre tonde separate (parte a incasso unica), include: miscelatore e deviatore a 2 uscite, presa acqua con supporto, doccetta in ottone e flessibile 150 cm.

2-way built-in shower mixer set on 3 separate round plates (single built-in part), including: mixer and 2-way diverter, water connection with holder, brass hand shower and 150cm flexible hose.

To be completed with a 2nd water outlet.

CR FIN A FIN B

□ □ □ 3 VIE - 3-WAY □ □ □



AI612D3

Miscelatore incasso con deviatore a 3 vie per vasca/doccia , 1 entrata e 3 uscite (articolo COMPLETO).

Built-in bath/shower mixer with 3-way diverter, 1 inlet and 3 outlets (COMPLETE item).

CR FIN A FIN B



AI712D3

Set miscelatore a incasso a 3 vie per doccia su piastra unica rettangolare, include: miscelatore, deviatore a 3 uscite, presa acqua con supporto, doccetta in ottone e flessibile 150 cm.

Da completare con una 2° ed una 3° uscita.

3-way built-in shower mixer set on a single rectangular plate, including: single-lever mixer, 3-way diverter, water connection with shower holder, brass hand shower and 150cm flexible hose. To be completed with a 2nd and 3rd water outlet.

CR FIN A FIN B



AI712D3P

Set miscelatore a incasso a 3 vie per doccia su 3 piastre tonde separate (parte a incasso unica), include: miscelatore e deviatore a 3 uscite, presa acqua con supporto, doccetta in ottone e flessibile 150cm.

3-way built-in shower mixer set on 3 separate round plates (single built-in part), including: mixer and 3-way diverter, water connection with holder, brass hand-shower and 150cm flexible hose.

To be completed with 2nd and 3rd water outlets.

CR FIN A FIN B

□ □ □ 4/5 VIE - 4/5-WAY □ □ □



AI612D4

Miscelatore incasso con deviatore a 4 vie per vasca/doccia , 1 entrata e 4 uscite (articolo COMPLETO).

Built-in bath/shower mixer with 4-way diverter, 1 inlet and 4 outlets (COMPLETE item).

CR FIN A FIN B



AI612D5

Miscelatore incasso con deviatore a 5 vie per vasca/doccia , 1 entrata e 5 uscite (articolo COMPLETO).

Built-in bath/shower mixer with 5-way diverter, 1 inlet and 5 outlets (COMPLETE item).

CR FIN A FIN B

KIT WELLNESS - WELLNESS KIT



Set doccia a incasso, composto da: miscelatore a incasso con deviatore AMBITION, asta saliscendi, attacco presa acqua a muro, braccio a muro in ottone 30cm, soffione in abs, doccetta in ABS a 3 funzioni con pulsante per il cambio dell'intensità, flessibile 150cm.
Built-in shower set, including: built-in mixer with diverter AMBITION, sliding rail, wall water connection, 30cm brass wall arm, abs shower head, 3-function abs hand shower with button for switching jet modes, 150cm flexible hose.

AI614GZSD20

Con soffione da 20x20 cm.
 With head shower 20x20 cm.

CR

AI614GZSD25

Con soffione da 25x25 cm.
 With head shower 25x25 cm.

CR

AI614GZSD30

Con soffione da 30x30 cm.
 With head shower 30x30 cm.

CR



Set doccia a incasso, composto da: miscelatore a incasso con deviatore AMBITION, attacco presa acqua a muro con supporto per doccetta, braccio a muro in ottone 30cm, soffione in abs, doccetta in ABS a 3 funzioni con pulsante per il cambio dell'intensità, flessibile 150cm.
Built-in shower set, including: built-in mixer with diverter AMBITION, wall water connection with hand shower holder, 30cm brass wall arm, abs shower head, 3-function abs hand shower with button for switching jet modes, 150cm flexible hose.

AI615GZSD20

Con soffione da 20x20 cm.
 With head shower 20x20 cm.

CR

AI615GZSD25

Con soffione da 25x25 cm.
 With head shower 25x25 cm.

CR

AI615GZSD30

Con soffione da 30x30 cm.
 With head shower 30x30 cm.

CR



Set doccia a incasso, composto da: miscelatore a incasso con deviatore su piastra lusso AMBITION, asta saliscendi in ottone, attacco presa acqua a muro, braccio a muro in ottone 30cm, soffione ultra piatto lucidato a specchio con angoli arrotondati, doccetta in ABS a 3 funzioni con pulsante per il cambio dell'intensità, flessibile 150cm.
Built-in shower set, including: built-in mixer with diverter on luxury plate AMBITION, brass sliding rail, wall water connection, 30cm brass wall arm, ultra-flat shower head in mirror-polished stainless steel with rounded corners, 3-function abs hand shower with button for switching jet modes, 150cm flexible hose.

AI614ZL7720

Con soffione da 20x20cm.
 With head shower 20x20 cm.

CR 15

AI614ZL7725

Con soffione da 25x25 cm.
 With head shower 25x25 cm.

CR 15

AI614ZL7730

Con soffione da 30x30 cm.
 With head shower 30x30 cm.

CR 15



Set doccia a incasso, composto da: miscelatore a incasso con deviatore su piastra lusso AMBITION, attacco presa acqua a muro con supporto per doccetta, braccio a muro in ottone 30cm, soffione ultra piatto lucidato a specchio con angoli arrotondati, doccetta in ABS a 3 funzioni con pulsante per il cambio dell'intensità, flessibile 150cm.

Built-in shower set, including: built-in mixer with diverter on luxury plate AMBITION, wall water connection with hand shower holder, 30cm brass wall arm, ultra-flat shower head in mirror-polished stainless steel with rounded corners, 3-function abs hand shower with button for switching jet modes, 150cm flexible hose.

AI615ZL7720

Con soffione da 20x20 cm.
With head shower 20x20 cm.

AI615ZL7725

Con soffione da 25x25 cm.
With head shower 25x25 cm.

AI615ZL7730

Con soffione da 30x30 cm.
With head shower 30x30 cm.



Set doccia a incasso, composto da: miscelatore a incasso con deviatore su piastra lusso AMBITION, asta saliscendi in ottone, attacco presa acqua a muro, braccio a muro in ottone 30cm, soffione in ottone, doccetta quadrata in ottone a 1 funzione, flessibile 150cm.

Built-in shower set, including: built-in mixer with diverter on luxury plate AMBITION, brass sliding rail, wall water connection, 30cm brass wall arm, brass shower head, 1-function squared brass hand shower, 150cm flexible hose.

AI614ZOL

Con soffione da 20x20 cm.
With head shower 20x20 cm.

AI614ZOL93B

Con soffione da 30x30 cm.
With head shower 30x30 cm.



Set doccia a incasso, composto da: miscelatore a incasso con deviatore su piastra lusso AMBITION, attacco presa acqua a muro con supporto per doccetta, braccio a muro in ottone 30cm, soffione in ottone, doccetta quadrata in ottone a 1 funzione, flessibile 150cm.

Built-in shower set, including: built-in mixer with diverter on luxury plate AMBITION, wall water connection with hand shower holder, 30cm brass wall arm, brass shower head, 1-function squared brass hand shower, 150cm flexible hose.

AI615ZOL

Con soffione da 20x20 cm.
With head shower 20x20 cm.

AI615ZOL93B

Con soffione da 30x30 cm.
With head shower 30x30 cm.



Set doccia a incasso, composto da: miscelatore a incasso su 3 piastre tonde con deviatore a 2 vie, presa acqua con doccetta in ottone e flessibile 150 cm, braccio a muro in ottone 30cm, soffione ultra piatto 20x20cm lucidato a specchio con angoli arrotondati.
 NB: miscelatore, deviatore e doccetta hanno piastre esterne separate, ma un'unica parte a incasso.
Built-in shower set, including: built-in mixer on 3 round plates with 2-way diverter, water intake with brass hand-shower and 150cm hose, 30cm brass wall arm, ultra-flat 20x20cm shower head in mirror-polished stainless steel with rounded corners.
 NB: mixer, diverter and hand-shower intake are on separate plates, but share one single built-in part.

AI715ZD2PL7720

Con soffione da 20x20 cm.
 With head shower 20x20 cm.

CR 15

AI715ZD2PL7725

Con soffione da 25x25 cm.
 With head shower 25x25 cm.

CR 15

AI715ZD2PL7730

Con soffione da 30x30 cm.
 With head shower 30x30 cm.

CR 15



Set doccia a incasso, composto da: miscelatore a incasso su piastra unica rettangolare con deviatore a 3 vie, presa acqua con supporto, doccetta in ottone a 1 funzione, flessibile 150 cm, soffione a parete in acciaio inox lucidato a specchio con getto pioggia e cascata.
Built-in shower set, including: built-in mixer on rectangular plate with 3-way diverter, water connection with shower holder, 1-function brass handshower, 150 cm hose, wall-mounted shower head in mirror-polished stainless steel with rain and waterfall jets.

AI715ZD32CA

CR 15



A1715ZD32CA15

AMBITION

TRILOGY

TIARA

TOKYO

SKYLINE

FUSION

DIVA

SPEED

SWING

JAX

COLONNE DOCCIA - SHOWER COLUMN



Set colonna vasca/doccia a 3 vie, composto da: miscelatore esterno vasca/doccia per colonna con deviatore AMBITION, colonna telescopica ad altezza regolabile, soffione ultra piatto lucidato a specchio con angoli arrotondati, doccetta in ABS a 3 funzioni con pulsante per il cambio dell'intensità, flessibile 150cm.

3-way bath/shower column set, including: exposed bath/shower mixer for column with diverter AMBITION, height-adjustable telescopic column, ultra-flat shower head in mirror-polished stainless steel with rounded corners, 3-function abs hand shower with button for switching jet modes, 150cm flexible hose.

AI636DA7720

Con soffione da 20x20 cm.
With head shower 20x20 cm.

CR	15
----	----

AI636DA7725

Con soffione da 25x25 cm.
With head shower 25x25 cm.

CR	15
----	----

AI636DA7730

Con soffione da 30x30 cm.
With head shower 30x30 cm.

CR	15
----	----



Set colonna doccia, composto da: miscelatore esterno per colonna AMBITION, colonna telescopica ad altezza regolabile con deviatore, flessibile doccia 150cm, soffione ultra piatto lucidato a specchio con angoli arrotondati, doccetta in ABS a 3 funzioni con pulsante per il cambio dell'intensità.

Shower column set, including: exposed mixer for column AMBITION, height-adjustable telescopic column with diverter, 150cm flexible hose, ultra-flat 20x20cm shower head in mirror-polished stainless steel with rounded corners, 3-function abs hand shower with button for switching jet modes.

AI636A7720

Con soffione da 20x20 cm.
With head shower 20x20 cm.

CR	15
----	----

AI636A7725

Con soffione da 25x25 cm.
With head shower 25x25 cm.

CR	15
----	----

AI636A7730

Con soffione da 30x30 cm.
With head shower 30x30 cm.

CR	15
----	----



Set colonna doccia, composto da: miscelatore esterno per colonna AMBITION, colonna con fissaggio superiore regolabile e deviatore, flessibile 150cm, soffione ultra piatto lucidato a specchio con angoli arrotondati, doccetta in ABS a 3 funzioni con pulsante per il cambio dell'intensità, Shower column set, including: exposed mixer for column AMBITION, column with adjustable upper fixing and diverter, 150cm flexible hose, ultra-flat shower head in mirror-polished stainless steel with rounded corners, 3-function abs hand shower with button for switching jet modes.

AI636X7720

Con soffione da 20x20 cm.
With head shower 20x20 cm.

CR	15
----	----

AI636X7725

Con soffione da 25x25 cm.
With head shower 25x25 cm.

CR	15
----	----

AI636X7730

Con soffione da 30x30 cm.
With head shower 30x30 cm.

CR	15
----	----

CUCINA - KITCHEN



AI684

Miscelatore monocomando per lavello, con canna alta girevole e sistema di doccetta monofunzione estraibile.
Single-lever sink mixer with high swivel spout and 1-function pull-out hand shower.



AI684DJ

Miscelatore monocomando per lavello, con canna alta girevole e doccetta estraibile a due funzioni.
Single-lever sink mixer with high swivel spout and 2-functions pull-out hand shower.

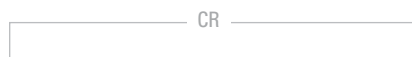

AI681M

Miscelatore monocomando per lavello, con canna alta girevole e doccetta estraibile con impugnatura a martello a due funzioni.
Single-lever sink mixer with high swivel spout and 2-functions pull-out "hammer shaped" handle hand shower.

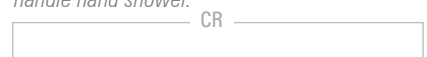

AI618Q

Miscelatore monocomando per lavello, con bocca alta girevole.
Single lever kitchen mixer with high swivel spout.



AI618

Miscelatore monocomando monoforo 90°, con canna alta a "U".
Single-lever sink mixer 90°, high "U" spout.



AI618C

Miscelatore monocomando per lavello/lavabo, con canna corta a "U", tipo lusso.
Single-lever one-hole sink/basin mixer, with short "U" spout, luxury type.



GOURMET



AI241

Miscelatore lavello con flessibile rivestito in tubo gomma soft-touch nero opaco.
Sink mixer with flexible hose coated in soft-touch matte black rubber pipe.



AI689

Miscelatore monocomando lavello a molla con doccetta estraibile dal supporto ed orientabile a due funzioni e cartuccia Ø 35.
Spring single-lever sink mixer with detachable and adjustable 2-functions hand shower and Ø 35 mm cartridge.



ACQUA DEPURATA
PURIFIED WATER



AI679DW

Miscelatore lavello a tre vie di ingresso con bocca girevole e due vie d'uscita completamente indipendenti, con selezione acqua potabile tramite la leva.
Three ways inlet single lever sink mixer, with movable spout and two fully independent outlets, with selection for drinking water directly from the lever.



AMBITION

TRILGY

TIARA

TOKYO

SKYLINE

FUSION

DIVA

SPEED

SWING

JAX





TRILOGY



TC632P15

La collezione TRILOGY è dedicata ai progetti di design più creativi. Le linee pulite e minimali dei miscelatori nella versione GLAM sono impreziosite nelle versioni ROCK e CLUB da leve intarsiate capaci di donare stile ed originalità ad ogni arredo.

CARATTERISTICHE TECNICHE:

La serie è dotata di cartuccia a dischi ceramici Ø 25 mm, tranne gli incassi che utilizzano la cartuccia a dischi ceramici Ø 35 mm.

Cartucce prodotte da S.T.S.R. – Studio Tecnico Sviluppo e Ricerche, www.stsr.it

TRILOGY collection is dedicated to the most creative design projects. The clean and minimal lines of the mixers in the GLAM version are enhanced in the ROCK and CLUB versions with inlaid levers able to feature any interior with style and originality.

TECHNICAL FEATURES:

The series is equipped with ceramic cartridge Ø25 mm, except for built-in items that use ceramic cartridge Ø35 mm.

Cartridges are produced by S.T.S.R. - Research Development Technical Department, www.stsr.it



TR606N

AMBITION

TRIOLOGY

TIARA

TOKYO

SKYLINE

FUSION

DIVA

SPEED

SWING

JAX



OM
V.OTTONE OPACO
MATT OLD BRASS

NP
NICHEL SPAZZOLATO
BRUSHED NICKEL

OIL
OIL BRONZE
OIL BRONZE

GLAM
(TG)



64
VECCHIO RAME
OLD COPPER

ROCK
(TR)



15
NERO OPACO
MATT BLACK

CLUB
(TC)



DP
ORO SPAZZOLATO
BRUSHED GOLD

OPZIONE LEVA - LEVER OPTION



LAVABI - WASHBASIN MIXERS



TG605

Monocomando lavabo, con scarico.
Single-lever basin mixer, with pop-up waste.

TG	CR	FIN A	FIN B
TR-TC	CR	FIN A	FIN B



TG606N

Monocomando lavabo, senza scarico e senza foro sul corpo.
Single-lever basin mixer, without waste and without body hole.

TG	CR	FIN A	FIN B
TR-TC	CR	FIN A	FIN B



TG607

Monocomando lavabo XL, con scarico click-clak.
XL basin mixer, with pop-up waste.

TG	CR	FIN A	FIN B
TR-TC	CR	FIN A	FIN B



TG655

Miscelatore monocomando lavabo due fori.
Scarico non incluso.
Two holes single-lever washbasin mixer.
Waste not included.

TG	CR	FIN A	FIN B
TR-TC	CR	FIN A	FIN B

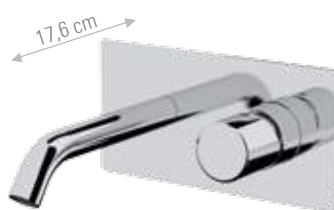

TG632

Miscelatore monocomando a incasso per lavabo, con piastra rettangolare.
Single-lever built-in basin mixer, with rectangular wall flange.

TG	CR	FIN A	FIN B
TR-TC	CR	FIN A	FIN B

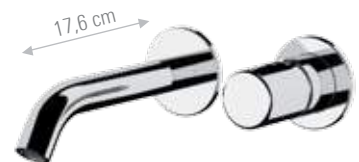

TG632P

Miscelatore monocomando da incasso per lavabo, su doppia piastra.
Built-in single-lever basin mixer with two separate plates.

TG	CR	FIN A	FIN B
TR-TC	CR	FIN A	FIN B



TG607B

Monocomando lavabo XL., senza scarico.
XL basin mixer, without waste.

TG	CR	FIN A	FIN B
TR-TC	CR	FIN A	FIN B



TG655L

Miscelatore monocomando lavabo due fori, con bocca L. Scarico non incluso.
Two holes single-lever washbasin mixer, with L spout. Waste not included.

TG	CR	FIN A	FIN B
TR-TC	CR	FIN A	FIN B

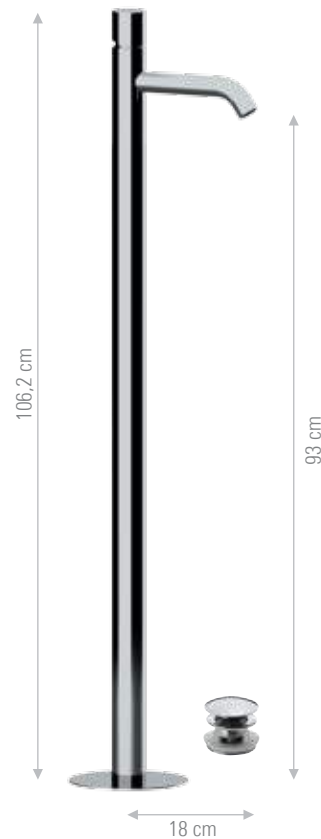

TG688

Miscelatore monocomando lavabo da pavimento con click-clack e troppo pieno.
Single-lever mixer floor mounting with click-clack and overflow.

TG	CR	FIN A	FIN B
TR-TC	CR	FIN A	FIN B

LAVABO BOX INCASSO - BUILT-IN BOX WASHBASIN MIXER

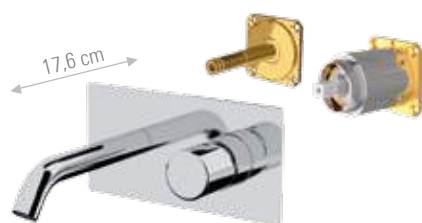

TG632KB

Miscelatore monocomando a incasso per lavabo, con piastra in ottone, bocca lunghezza 17 cm, da abbinare al box incasso.
Single-lever built-in basin mixer, with wall flange in brass, spout length 17 cm, to use with the built-in box.

TG	CR	FIN A	FIN B
TR-TC	CR	FIN A	FIN B



DANBOX632

Box incasso per miscelatore monocomando a incasso per lavabo.
Built-in box for single-lever built-in basin mixer.

CR

BIDET



TG604

Miscelatore bidet, con scarico.
Bidet mixer, with pop-up waste.

TG	CR	FIN A	FIN B
TR-TC	CR	FIN A	FIN B



TG604BN

Miscelatore bidet, senza scarico e senza foro sul corpo
Bidet mixer, without waste and without body hole.

TG	CR	FIN A	FIN B
TR-TC	CR	FIN A	FIN B



TG6454DC

Miscelatore incasso per shut-off comprensivo di doccetta shut-off art. 1004DC, supporto doccia-presa acqua, tutto in ottone cromato e flessibile doccia cm 120 in acciaio inox.
Built-in shower mixer set including :shut-off art. 1004DC, shower holder-water punch on flange, all in c.p. brass and shower flexible cm 120 in stainless steel.

TG	CR	FIN A	FIN B
TR-TC	CR	FIN A	FIN B

MISCELATORI VASCA E DOCCIA
SHOWER AND BATH MIXERS



TG610

Miscelatore vasca esterno, con kit doccia in ottone, flessibile 150 cm.
Exposed bath mixer, with brass hand-shower kit, flexible 150 cm.

TG	CR	FIN A	FIN B
TR-TC	CR	FIN A	FIN B



TG600H

Miscelatore vasca esterno, senza kit doccia.
Exposed bath mixer, without shower kit.

TG	CR	FIN A	FIN B
TR-TC	CR	FIN A	FIN B

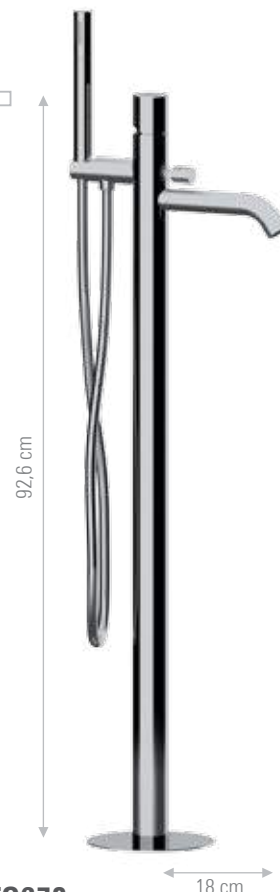

TG678

Miscelatore vasca da pavimento con deviatore e kit doccia in ottone.
Free standing bath mixer floor mounting with diverter and brass shower kit.

TG	CR	FIN A	FIN B
TR-TC	CR	FIN A	FIN B

□ □ □ 2 VIE - 2-WAY □ □ □

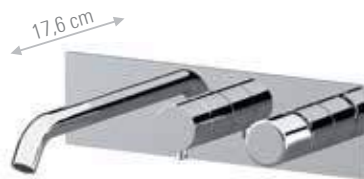

TG700D2Q

Set miscelatore a incasso a 2 vie per vasca/doccia su piastra unica rettangolare, include miscelatore monocomando, deviatore a 2 uscite, bocca a muro. Da completare con una seconda uscita acqua.
2-way built-in mixer set for bathtub / shower on single rectangular plate, including single-lever mixer, 2-way diverter, wall spout. To be completed with a second water outlet.

TG	CR	FIN A	FIN B
TR-TC	CR	FIN A	FIN B



TG700D2P

Set miscelatore a incasso a 2 vie per vasca/doccia su 3 piastre tonde separate (piastre separate e incasso unico), include: miscelatore monocomando, deviatore a 2 uscite, bocca a muro. Da completare con una seconda uscita.
2-way built-in mixer set for bathtub / shower on 3 separate round plates (separate plates, one single built-in part), including: single-lever mixer, 2-way diverter, wall spout. To be completed with a second water outlet.

TG	CR	FIN A	FIN B
TR-TC	CR	FIN A	FIN B



TG710D2Q

Set a incasso a 2 vie per vasca, include: miscelatore monocomando, deviatore a 2 uscite e bocca a muro su piastra unica rettangolare; set doccia su piastra quadrata con presa acqua, supporto integrato, doccetta in ottone e flessibile 150cm.
2-way built-in set for bathtub, including: single-lever mixer, 2-way diverter and wall spout on a single rectangular plate; shower set on square plate with water connection, holder, brass handshower and 150cm flexible hose.

TG	CR	FIN A	FIN B
TR-TC	CR	FIN A	FIN B



TG710D2P

Set a incasso a 2 vie per vasca su piastre tonde separate (3 piastre separate e incasso unico), include: miscelatore monocomando con deviatore a 2 uscite, bocca a muro; set doccia su piastra tonda con presa acqua, supporto, doccetta e flessibile 150cm.
2-way built-in set for bathtub on separate round plates (3 separate plates, one single built-in part), including: single-lever mixer, 2-way diverter, wall spout; Shower set on round plate with water connection, holder, hand shower and 150cm flexible hose.

TG	CR	FIN A	FIN B
TR-TC	CR	FIN A	FIN B

□ □ □ 3 VIE - 3-WAY □ □ □

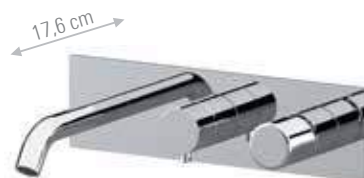

TG700D3Q

Set miscelatore a incasso a 3 vie per vasca/doccia su piastra unica rettangolare, include miscelatore monocomando, deviatore a 3 uscite, bocca a muro. Da completare con una seconda e una terza uscita acqua.
3-way built-in mixer set for bathtub/shower on single rectangular plate, including single-lever mixer, 3-way diverter, wall spout. To be completed with second and third water outlets.

TG	CR	FIN A	FIN B
TR-TC	CR	FIN A	FIN B



TG700D3P

Set miscelatore a incasso a 3 vie per vasca/doccia su 3 piastre tonde separate (piastre separate e parte a incasso unica), composto da: miscelatore monocomando con deviatore a 3 uscite, bocca a muro. Da completare con una seconda e una terza uscita acqua.
3-way built-in mixer set for bathtub/shower on 3 separate round plates (separate plates, one single built-in part), including: single-lever mixer with 3-way diverter, wall spout. To be completed with second and third water outlets.

TG	CR	FIN A	FIN B
TR-TC	CR	FIN A	FIN B

INCASSI DOCCIA - BUILT-IN MIXERS

□ □ □ 1 VIA - 1-WAY □ □ □



TG602

Miscelatore incasso per doccia (articolo COMPLETO).
Built-in shower mixer (COMPLETE item).

TG	CR	FIN A	FIN B
TR-TC	CR	FIN A	FIN B

IN602C35

SOLO parti a incasso
Built-in parts ONLY.

CR	FIN A	FIN B
----	-------	-------

TG602EKIT

SOLO parti esterne.
Exposed parts ONLY.

TG	CR	FIN A	FIN B
TR-TC	CR	FIN A	FIN B



TG602Q

Miscelatore incasso per doccia, piastra quadra (articolo COMPLETO).
Built-in shower mixer, square plate (COMPLETE item).

TG	CR	FIN A	FIN B
TR-TC	CR	FIN A	FIN B

IN602C35

SOLO parti a incasso
Built-in parts ONLY.

CR	FIN A	FIN B
----	-------	-------

TG602QEKIT

SOLO parti esterne.
Exposed parts ONLY.

TG	CR	FIN A	FIN B
TR-TC	CR	FIN A	FIN B

□ □ □ 2 VIE - 2-WAY □ □ □



TG612

Miscelatore incasso con deviatore per vasca/doccia (articolo COMPLETO).
Built-in bath/shower mixer with diverter (COMPLETE item).

TG	CR	FIN A	FIN B
TR-TC	CR	FIN A	FIN B

IN612C35

SOLO parti a incasso
Built-in parts ONLY.

CR	FIN A	FIN B
----	-------	-------

TG612EKIT

SOLO parti esterne.
Exposed parts ONLY.

TG	CR	FIN A	FIN B
TR-TC	CR	FIN A	FIN B



TG612Q

Miscelatore incasso con deviatore per vasca/doccia, piastra quadra (articolo COMPLETO).
Built-in bath/shower mixer with diverter, square plate (COMPLETE item).

TG	CR	FIN A	FIN B
TR-TC	CR	FIN A	FIN B

IN612C35

SOLO parti a incasso
Built-in parts ONLY.

CR	FIN A	FIN B
----	-------	-------

TG612QEKIT

SOLO parti esterne.
Exposed parts ONLY.

TG	CR	FIN A	FIN B
TR-TC	CR	FIN A	FIN B

□ □ □ 2 VIE - 2-WAY □ □ □



TG612D2

Miscelatore incasso con deviatore a 2 vie per vasca/doccia su piastra unica (articolo COMPLETO).

Built-in bath/shower mixer with 2-way diverter on single plate (COMPLETE item).

TG	CR	FIN A	FIN B
TR-TC	CR	FIN A	FIN B



TG612D2Q

Miscelatore incasso con deviatore a 2 vie per vasca/doccia su piastra unica rettangolare (articolo COMPLETO).

Built-in bath/shower mixer with 2-way diverter on single rectangular plate (COMPLETE item).

TG	CR	FIN A	FIN B
TR-TC	CR	FIN A	FIN B



TG712D2P

Set miscelatore a incasso a 2 vie per doccia su 3 piastre tonde separate (parte a incasso unica), include: miscelatore e deviatore a 2 uscite, presa acqua con supporto, doccetta in ottone e flessibile 150 cm.

Da completare con una 2° uscita.
2-way built-in shower mixer set on 3 separate round plates (single built-in part), including: mixer and 2-way diverter, water connection with holder, brass hand shower and 150cm flexible hose.

To be completed with a 2nd water outlet.

TG	CR	FIN A	FIN B
TR-TC	CR	FIN A	FIN B



TG712D2Q

Set miscelatore a incasso a 2 vie per doccia su piastra unica rettangolare, include presa acqua con supporto, doccetta e flessibile 150 cm.

Da completare con una 2° uscita.
2-way built-in shower mixer set on a single rectangular plate, including water connection with shower holder, hand shower and 150cm hose.

To be completed with a 2nd water outlet.

TG	CR	FIN A	FIN B
TR-TC	CR	FIN A	FIN B

□ □ □ 3 VIE - 3-WAY □ □ □



TG612D3

Miscelatore incasso con deviatore a 3 vie per vasca/doccia , 1 entrata e 3 uscite (articolo COMPLETO).

Built-in bath/shower mixer with 3-way diverter, 1 inlet and 3 outlets (COMPLETE item).

TG	CR	FIN A	FIN B
TR-TC	CR	FIN A	FIN B



TG612D3Q

Miscelatore incasso con deviatore a 3 vie per vasca/doccia , 1 entrata e 3 uscite su piastra rettangolare (articolo COMPLETO).

Built-in bath/shower mixer with 3-way diverter, 1 inlet and 3 outlets on rectangular plate (COMPLETE item).

TG	CR	FIN A	FIN B
TR-TC	CR	FIN A	FIN B



TG712D3Q

Set miscelatore a incasso a 3 vie per doccia su piastra unica rettangolare, include: miscelatore, deviatore a 3 uscite, presa acqua con supporto, doccetta in ottone e flessibile 150 cm. Da completare con una 2° ed una 3° uscita.

3-way built-in shower mixer set on a single rectangular plate, including: single-lever mixer, 3-way diverter, water connection with shower holder, brass hand-shower and 150cm flexible hose. To be completed with a 2nd and 3rd water outlet.

TG	CR	FIN A	FIN B
TR-TC	CR	FIN A	FIN B



TG712D3P

Set miscelatore a incasso a 3 vie per doccia su 3 piastre tonde separate (parte a incasso unica), include: miscelatore e deviatore a 3 uscite, presa acqua con supporto, doccetta in ottone e flessibile 150cm.

Da completare con una 2° ed una 3° uscita. 3-way built-in shower mixer set on 3 separate round plates (single built-in part), including: mixer and 3-way diverter, water connection with holder, brass hand-shower and 150cm flexible hose. To be completed with a 2nd and 3rd water outlet.

TG	CR	FIN A	FIN B
TR-TC	CR	FIN A	FIN B

□ □ □ 4/5 VIE - 4/5-WAY □ □ □



TG612D4

Miscelatore incasso con deviatore a 4 vie per vasca/doccia , 1 entrata e 4 uscite (articolo COMPLETO).

Built-in bath/shower mixer with 4-way diverter, 1 inlet and 4 outlets (COMPLETE item).

TG	CR	FIN A	FIN B
TR-TC	CR	FIN A	FIN B



TG612D4Q

Miscelatore incasso con deviatore a 4 vie per vasca/doccia , 1 entrata e 4 uscite su piastra quadra (articolo COMPLETO).

Built-in bath/shower mixer with 4-way diverter, 1 inlet and 4 outlets on square plate (COMPLETE item).

TG	CR	FIN A	FIN B
TR-TC	CR	FIN A	FIN B



TG612D5

Miscelatore incasso con deviatore a 5 vie per vasca/doccia , 1 entrata e 5 uscite (articolo COMPLETO).

Built-in bath/shower mixer with 5-way diverter, 1 inlet and 5 outlets (COMPLETE item).

TG	CR	FIN A	FIN B
TR-TC	CR	FIN A	FIN B



TG612D5Q

Miscelatore incasso con deviatore a 5 vie per vasca/doccia , 1 entrata e 5 uscite su piastra quadra (articolo COMPLETO).

Built-in bath/shower mixer with 5-way diverter, 1 inlet and 5 outlets on square plate. (COMPLETE item).

TG	CR	FIN A	FIN B
TR-TC	CR	FIN A	FIN B

————— KIT WELLNESS - WELLNESS KIT —————



Set doccia a incasso, composto da: miscelatore a incasso con deviatore TRILOGY-Glam, attacco presa acqua a muro con supporto per doccetta, braccio a muro in ottone 30cm, soffione a pioggia tondo, altezza 3cm, acciaio inox lucidato a specchio, doccetta in ottone a 1 funzione, flessibile 150cm.

Built-in shower set, including: built-in mixer with diverter TRILOGY-Glam, wall water connection with hand shower holder, 30cm brass wall arm, round shower head, height 3cm, mirror polished stainless steel, 1-function brass hand shower, 150cm flexible hose.

TG615ZL8322

Con soffione da Ø 22,5 cm.
With head shower Ø 22,5 cm.

TG	CR	15
TR-TC	CR	15

TG615ZL8332

Con soffione da Ø 32,5 cm.
With head shower Ø 32,5 cm.

TG	CR	15
TR-TC	CR	15



Set doccia a incasso, composto da: miscelatore a incasso su piastra unica con deviatore a 2 vie, presa acqua con doccetta in ottone e flessibile 150 cm, soffione a parete in acciaio inox lucidato a specchio,

Built-in shower set, including: built-in mixer on 1 plate with 2-way diverter, water intake with brass hand-shower and 150cm hose, wall-mounted shower head in mirror-polished stainless steel.

TG715ZD2Q562

TG	CR	15
TR-TC	CR	15



Set doccia a incasso, composto da: miscelatore a incasso su 3 piastre tonde con deviatore a 3 vie, presa acqua con doccetta in ottone e flessibile 150 cm, soffione a parete in acciaio inox lucidato a specchio, bocca rotonda a incasso con getto a cascata in acciaio inox lucidato a specchio.

NB: miscelatore, deviatore e doccetta hanno piastre esterne separate, ma un'unica parte a incasso.

Built-in shower set, including: built-in mixer on 3 round plates with 3-way diverter, water intake with brass hand-shower and 150cm hose, wall-mounted shower head in mirror-polished stainless steel, round built-in spout with cascade jet in mirror-polished stainless steel.

NB: mixer, diverter and hand-shower intake are on separate plates, but share one single built-in part.

TG715ZD3PXT566

TG	CR	15
TR-TC	CR	15



Set doccia a incasso, composto da: miscelatore a incasso su 3 piastre tonde con deviatore a 2 vie, presa acqua con doccetta in ottone e flessibile 150 cm, braccio a muro in ottone 30cm, soffione in ottone.

NB: miscelatore, deviatore e doccetta hanno piastre esterne separate, ma un'unica parte a incasso.

Built-in shower set, including: built-in mixer on 3 round plates with 2-way diverter, water intake with brass hand-shower and 150cm hose, 30cm brass wall arm, brass shower head.

NB: mixer, diverter and hand-shower intake are on separate plates, but share one single built-in part.

TG715ZOD2PL

Con soffione da Ø 20 cm.
With head shower Ø 20 cm.

TG	CR	FIN A	FIN B
TR-TC	CR	FIN A	FIN B



TG715ZOD2PL9430

Con soffione da Ø 30 cm.
With head shower Ø 30 cm.

TG	CR	FIN A	FIN B
TR-TC	CR	FIN A	FIN B



TIARA

TIARA





Tiara è la combinazione ideale tra linee curve e facce rigide. La presenza frontale di superfici sfaccettate come diamanti caratterizza il design di tutti gli elementi. Il risultato è una perfetta armonia estetica, esaltata dalle molteplici riflessioni di luce dell'ambiente circostante, che diversificano la serie da ogni altro prodotto in commercio.

.....

CARATTERISTICHE TECNICHE:

La serie è dotata di cartuccia a dischi ceramici, Ø 35 mm, prodotta da S.T.S.R. – Studio Tecnico Sviluppo e Ricerche - www.stsr.it

TIARA is the ideal combination of curved lines and stiff facets. The presence of frontal faceted surfaces like diamonds characterizes the design of all elements. The result is a perfect aesthetic harmony, enhanced by multiple ambient light reflections differentiating the series from any other product on the market.

.....

TECHNICAL FEATURES:

The series is equipped with ceramic cartridge, Ø 35 mm, produced by S.T.S.R. - Research Development Technical Office - www.stsr.it



TIARA

TA606NDO

15

NERO OPACO
MATT BLACK



TA632P15

OIL
OIL BRONZE
OIL BRONZE



TA600HOIL

DP
ORO SPAZZOLATO
BRUSHED GOLD



TA632PDP

AMBITION

TRILOGY

TIARA

TOKYO

SKYLINE

FUSION

DIVA

SPEED

SWING

JAX

LAVABI - WASHBASIN MIXERS



TA605

Monocomando lavabo, con scarico.
Single-lever basin mixer, with pop-up waste.

CR FIN A FIN B



TA606N

Monocomando lavabo, senza scarico e senza foro sul corpo.
Single-lever basin mixer, without waste and without body hole.

CR FIN A FIN B



TA607

Monocomando lavabo XL., con scarico click-clak.
XL basin mixer, with pop-up waste.

CR FIN A FIN B



TA655

Miscelatore monocomando a due fori per lavabo. Scarico non incluso.
Two-hole single-lever washbasin mixer. Waste not included.

CR FIN A FIN B



TA632

Miscelatore monocomando a incasso per lavabo, con piastra rettangolare.
Lunghezza bocca: 19 cm.
Single-lever built-in basin mixer, with rectangular wall flange.
Spout length: 19 cm.

CR FIN A FIN B

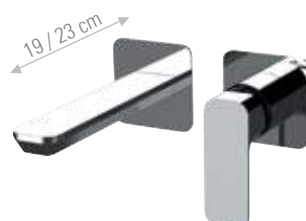

TA632P

Miscelatore monocomando da incasso per lavabo, su doppia piastra.
Lunghezza bocca: 19 cm.
Built-in single-lever basin mixer with two separate plates.
Spout length: 19 cm.

CR FIN A FIN B



TA655L

Miscelatore monocomando a due fori per lavabo. Scarico non incluso.
Two-hole single-lever washbasin mixer. Waste not included.

CR FIN A FIN B

TA632L

Miscelatore monocomando a incasso per lavabo, con piastra rettangolare.
Lunghezza bocca: 23 cm.
Single-lever built-in basin mixer, with rectangular wall flange.
Spout length: 23 cm.

CR FIN A FIN B

TA632PL

Miscelatore monocomando da incasso per lavabo, su doppia piastra.
Lunghezza bocca: 23 cm.
Built-in single-lever basin mixer with two separate plates.
Spout length: 23 cm.

CR FIN A FIN B

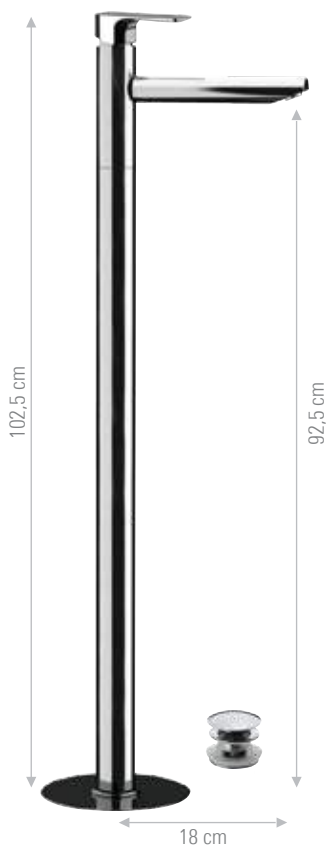

TA688

Miscelatore monocomando lavabo da pavimento con click-clack e troppo pieno.
Single-lever mixer floor mounting with click-clack and overflow.

CR	FIN A	FIN B
----	-------	-------

LAVABO BOX INCASSO BUILT-IN BOX WASHBASIN MIXER



TA632KB

Miscelatore monocomando a incasso per lavabo, con piastra in ottone, bocca lunghezza 19 cm, da abbinare al box incasso.
Single-lever built-in basin mixer, with wall flange in brass, spout length 19 cm, to use with the built-in box.

CR	FIN A	FIN B
----	-------	-------

DANBOX632

Box incasso per miscelatore monocomando a incasso per lavabo.
Built-in box for single-lever built-in basin mixer.

CR

TA632LKB

Miscelatore monocomando a incasso per lavabo, con piastra in ottone, bocca lunghezza 23 cm, da abbinare al box incasso.
Single-lever built-in basin mixer, with wall flange in brass, spout length 23 cm, to use with the built-in box.

CR	FIN A	FIN B
----	-------	-------



TA604

Miscelatore bidet, con scarico.
Bidet mixer, with pop-up waste.

CR	FIN A	FIN B
----	-------	-------



TA604B

Miscelatore bidet, senza scarico.
Bidet mixer, without waste.

CR	FIN A	FIN B
----	-------	-------

BIDET



TA645BP4DCCR

Kit a incasso per shut-off, in ottone, comprensivo di miscelatore a incasso con supporto doccia e presa acqua integrati, doccetta shut-off art. 1000BDC e flessibile doccia cm 120.
Built-in kit for shut-off, in brass, including built-in mixer with shower holder and water connection, shut-off hand shower art. 1000BDC and 120 cm shower hose.

CR	FIN A	FIN B
----	-------	-------

MISCELATORI VASCA E DOCCIA - SHOWER AND BATH MIXERS



TA610

Miscelatore vasca esterno, con deviatore e kit doccia, flessibile 150 cm.
Exposed bath mixer, with diverter and shower kit, flexible 150 cm.

CR FIN A FIN B



TA631A

Monocomando doccia esterno, con kit doccia, flessibile 150 cm.
Exposed shower mixer, with shower kit, flexible 150 cm.

CR FIN A FIN B

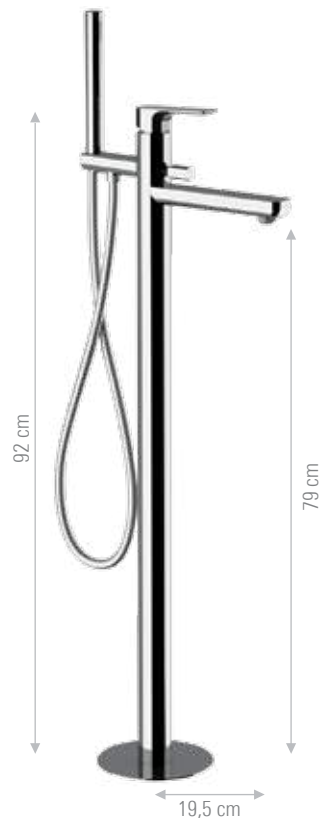

TA600H

Miscelatore vasca esterno con deviatore integrato, senza kit doccia.
Exposed bath mixer with integrated diverter, without shower kit.

CR FIN A FIN B



TA631

Monocomando doccia esterno, senza kit doccia.
Exposed shower mixer, without shower kit.

CR FIN A FIN B

TA678

Miscelatore vasca da pavimento con deviatore e kit doccia.
Free standing bath mixer floor mounting with diverter and shower kit.

CR FIN A FIN B



DOCCETTA IN FINITURA
FINISH HAND SHOWER

Il modello della doccetta inclusa nel kit può variare in base alla finitura scelta.
The model of the hand shower included in the kit may vary according to the chosen finish.

CR	FIN A						FIN B				
CR	15	14	NP	63	OIL	64	DO	DP	FZ	CF	RP
Doccetta abs, 4 funzioni. ABS hand shower, 4-function.			Doccetta minimale in ottone, 1 funzioni. Minimal brass hand shower, 1-function.								

□ □ □ 2 VIE - 2-WAY □ □ □



TA700D2

Set miscelatore a incasso a 2 vie per vasca/doccia su piastra unica rettangolare, include miscelatore monocomando, deviatore a 2 uscite, bocca a muro. Da completare con una seconda uscita acqua.
2-way built-in mixer set for bathtub / shower on single rectangular plate, including single-lever mixer, 2-way diverter, wall spout. To be completed with a second water outlet.

CR FIN A FIN B

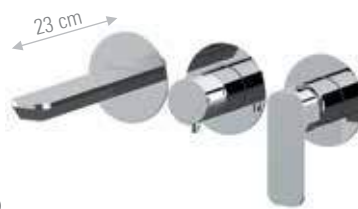

TA700D2P

Set miscelatore a incasso a 2 vie per vasca/doccia su 3 piastre tonde separate (piastre separate e incasso unico), include: miscelatore monocomando, deviatore a 2 uscite, bocca a muro. Da completare con una seconda uscita.
2-way built-in mixer set for bathtub / shower on 3 separate round plates (separate plates, one single built-in part), including: single-lever mixer, 2-way diverter, wall spout. To be completed with a second water outlet.

CR FIN A FIN B



TA710D2

Set a incasso a 2 vie per vasca, include: miscelatore monocomando, deviatore a 2 uscite e bocca a muro su piastra unica rettangolare; set doccia su piastra quadrata con presa acqua, supporto integrato, doccetta in ottone e flessibile 150cm.
2-way built-in set for bathtub, including: single-lever mixer, 2-way diverter and wall spout on a single rectangular plate; shower set on square plate with water connection, holder, brass handshower and 150cm flexible hose.

CR FIN A FIN B



TA710D2P

Set a incasso a 2 vie per vasca su piastre tonde separate (3 piastre separate e incasso unico), include: miscelatore monocomando con deviatore a 2 uscite, bocca a muro; set doccia su piastra tonda con presa acqua, supporto, doccetta e flessibile 150cm.
2-way built-in set for bathtub on separate round plates (3 separate plates, one single built-in part), including: single-lever mixer, 2-way diverter, wall spout; Shower set on round plate with water connection, holder, hand shower and 150cm flexible hose.

CR FIN A FIN B

□ □ □ 3 VIE - 3-WAY □ □ □



TA700D3

Set miscelatore a incasso a 3 vie per vasca/doccia su piastra unica rettangolare, include miscelatore monocomando, deviatore a 3 uscite, bocca a muro. Da completare con una seconda e una terza uscita acqua.
3-way built-in mixer set for bathtub/shower on single rectangular plate, including single-lever mixer, 3-way diverter, wall spout. To be completed with second and third water outlets.

CR FIN A FIN B



TA700D3P

Set miscelatore a incasso a 3 vie per vasca/doccia su 3 piastre tonde separate (piastre separate e parte a incasso unica), composto da: miscelatore monocomando con deviatore a 3 uscite, bocca a muro. Da completare con una seconda e una terza uscita acqua.
3-way built-in mixer set for bathtub/shower on 3 separate round plates (separate plates, one single built-in part), including: single-lever mixer with 3-way diverter, wall spout. To be completed with second and third water outlets.

CR FIN A FIN B

INCASSI DOCCIA - BUILT-IN MIXERS

□ □ □ 1 VIA - 1-WAY □ □ □



TA602G

Miscelatore incasso per doccia (articolo COMPLETO).
Built-in shower mixer (COMPLETE item).

CR FIN A FIN B

IN602C35

SOLO parti a incasso
Built-in parts ONLY.

CR FIN A FIN B

TA602GEKIT

SOLO parti esterne.
Exposed parts ONLY.

CR FIN A FIN B



TA602

Miscelatore incasso per doccia su piastra lusso ultrapiatta (articolo COMPLETO).
Built-in shower mixer on luxury ultraslim plate (COMPLETE item).

CR FIN A FIN B

IN602C35

SOLO parti a incasso
Built-in parts ONLY.

CR FIN A FIN B

TA602EKIT

SOLO parti esterne.
Exposed parts ONLY.

CR FIN A FIN B

□ □ □ 2 VIE - 2-WAY □ □ □



TA612G

Miscelatore incasso con deviatore per vasca/doccia (articolo COMPLETO).
Built-in bath/shower mixer with diverter (COMPLETE item).

CR FIN A FIN B

IN612C35

SOLO parti a incasso
Built-in parts ONLY.

CR FIN A FIN B

TA612GEKIT

SOLO parti esterne.
Exposed parts ONLY.

CR FIN A FIN B



TA612

Miscelatore incasso con deviatore per vasca/doccia su piastra lusso ultrapiatta (articolo COMPLETO).
Built-in bath/shower mixer with diverter on luxury ultraslim plate (COMPLETE item).

CR FIN A FIN B

IN612C35

SOLO parti a incasso
Built-in parts ONLY.

CR FIN A FIN B

TA612EKIT

SOLO parti esterne.
Exposed parts ONLY.

CR FIN A FIN B



TA612D2

Miscelatore incasso con deviatore a 2 vie per vasca/doccia su piastra lusso ultrapiatta (articolo COMPLETO).
Built-in bath/shower mixer with 2-way diverter on luxury ultraslim plate (COMPLETE item).

CR FIN A FIN B



TA712D2

Set miscelatore a incasso a 2 vie per doccia su piastra unica rettangolare, include presa acqua con supporto, doccia e flessibile 150 cm. Da completare con una 2° uscita.
2-way built-in shower mixer set on a single rectangular plate, including water connection with shower holder, hand shower and 150cm hose. To be completed with a 2nd water outlet.

CR FIN A FIN B



TA712D2P

Set miscelatore a incasso a 2 vie per doccia su 3 piastre tonde separate (parte a incasso unica), include: miscelatore e deviatore a 2 uscite, presa acqua con supporto, doccia in ottone e flessibile 150 cm. Da completare con una 2° uscita.
2-way built-in shower mixer set on 3 separate round plates (single built-in part), including: mixer and 2-way diverter, water connection with holder, brass hand shower and 150cm flexible hose. To be completed with a 2nd water outlet.

CR FIN A FIN B

□ □ □ 3 VIE - 3-WAY □ □ □



TA612D3

Miscelatore incasso con deviatore a 3 vie per vasca/doccia , 1 entrata e 3 uscite (articolo COMPLETO).
Built-in bath/shower mixer with 3-way diverter, 1 inlet and 3 outlets (COMPLETE item).

CR FIN A FIN B



TA712D3

Set miscelatore a incasso a 3 vie per doccia su piastra unica rettangolare, include: miscelatore, deviatore a 3 uscite, presa acqua con supporto, doccia in ottone e flessibile 150 cm. Da completare con una 2° ed una 3° uscita.
3-way built-in shower mixer set on a single rectangular plate, including: single-lever mixer, 3-way diverter, water connection with shower holder, brass hand shower and 150cm flexible hose. To be completed with a 2nd and 3rd water outlet.

CR FIN A FIN B



TA712D3P

Set miscelatore a incasso a 3 vie per doccia su 3 piastre tonde separate (parte a incasso unica), include: miscelatore e deviatore a 3 uscite, presa acqua con supporto, doccia in ottone e flessibile 150cm. Da completare con una 2° ed una 3° uscita.
3-way built-in shower mixer set on 3 separate round plates (single built-in part), including: mixer and 3-way diverter, water connection with holder, brass hand-shower and 150cm flexible hose. To be completed with 2nd and 3rd water outlets.

CR FIN A FIN B

□ □ □ 4/5 VIE - 4/5-WAY □ □ □



TA612D4

Miscelatore incasso con deviatore a 4 vie per vasca/doccia , 1 entrata e 4 uscite (articolo COMPLETO).
Built-in bath/shower mixer with 4-way diverter, 1 inlet and 4 outlets (COMPLETE item).

CR FIN A FIN B



TA612D5

Miscelatore incasso con deviatore a 5 vie per vasca/doccia , 1 entrata e 5 uscite (articolo COMPLETO).
Built-in bath/shower mixer with 5-way diverter, 1 inlet and 5 outlets (COMPLETE item).

CR FIN A FIN B

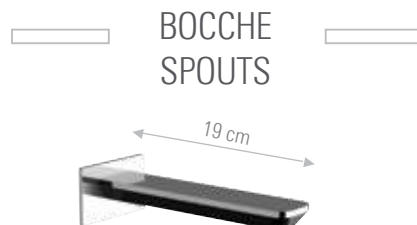

BOCCHIE SPOUTS

TA4704

Bocca incasso.
Built-in spout.

CR FIN A FIN B

TA4704L

Bocca incasso, lunghezza 23cm.
Built-in spout, 23cm length.

CR FIN A FIN B

COLONNE DOCCIA - SHOWER COLUMN



Set colonna vasca/doccia a 3 vie, composto da: miscelatore esterno vasca/doccia per colonna con deviatore TIARA, colonna telescopica ad altezza regolabile, soffione ultra piatto lucidato a specchio con angoli arrotondati, doccetta in ABS a 3 funzioni con pulsante per il cambio dell'intensità, flessibile 150cm.

3-way bath/shower column set, including: exposed bath/shower mixer for column with diverter TIARA, height-adjustable telescopic column, ultra-flat shower head in mirror-polished stainless steel with rounded corners, 3-function abs hand shower with button for switching jet modes, 150cm flexible hose.

TA636DA7720

Con soffione da 20x20 cm.
With head shower 20x20 cm.

CR 15

TA636DA7725

Con soffione da 25x25 cm.
With head shower 25x25 cm.

CR 15

TA636DA7730

Con soffione da 30x30 cm.
With head shower 30x30 cm.

CR 15



TA636DAAD20

Set colonna vasca/doccia a 3 vie, composto da: miscelatore esterno vasca/doccia per colonna con deviatore TIARA, colonna telescopica ad altezza regolabile, soffione 20x20cm in abs con angoli arrotondati, doccetta in ABS a 3 funzioni con pulsante per il cambio dell'intensità, flessibile 150cm.

3-way bath/shower column set, including: exposed bath/shower mixer for column with diverter TIARA, height-adjustable telescopic column, 20x20cm c.p. abs shower head with rounded corners, 3-function abs hand shower with button for switching jet modes, 150cm flexible hose.

CR



Set colonna doccia, composto da: miscelatore esterno per colonna TIARA, colonna con fissaggio superiore regolabile e deviatore, flessibile 150cm, soffione ultra piatto lucidato a specchio con angoli arrotondati, doccetta in ABS a 3 funzioni con pulsante per il cambio dell'intensità.

Shower column set, including: exposed mixer for column TIARA, column with adjustable upper fixing and diverter, 150cm flexible hose, ultra-flat shower head in mirror-polished stainless steel with rounded corners, 3-function abs hand shower with button for switching jet modes.

TA636X7720

Con soffione da 20x20 cm.
With head shower 20x20 cm.

CR 15

TA636X7725

Con soffione da 25x25 cm.
With head shower 25x25 cm.

CR 15

TA636X7730

Con soffione da 30x30 cm.
With head shower 30x30 cm.

CR 15



Set colonna doccia, composto da: miscelatore esterno per colonna TIARA, colonna telescopica ad altezza regolabile con deviatore, flessibile doccia 150cm, soffione ultra piatto lucidato a specchio con angoli arrotondati, doccetta in ABS a 3 funzioni con pulsante per il cambio dell'intensità.

Shower column set, including: exposed mixer for column TIARA, height-adjustable telescopic column with diverter, 150cm flexible hose, ultra-flat shower head in mirror-polished stainless steel with rounded corners, 3-function abs hand shower with button for switching jet modes.

TA636A7720

Con soffione da 20x20 cm.
With head shower 20x20 cm.

CR 15

TA636A7725

Con soffione da 25x25 cm.
With head shower 25x25 cm.

CR 15

TA636A7730

Con soffione da 30x30 cm.
With head shower 30x30 cm.

CR 15

KIT WELLNESS - WELLNESS KIT



TA614GZAD20

Set doccia a incasso, composto da: miscelatore a incasso con deviatore TIARA, asta saliscendi, attacco presa acqua a muro, braccio a muro in ottone 30cm, soffione 20x20cm in abs con angoli arrotondati, doccetta in ABS a 3 funzioni con pulsante per il cambio dell'intensità, flessibile 150cm.
Built-in shower set, including: built-in mixer with diverter TIARA, sliding rail, wall water connection, 30cm brass wall arm, 20x20cm c.p. abs shower head with rounded corners, 3-function abs hand shower with button for switching jet modes, 150cm flexible hose.

CR



TA615GZAD20

Set doccia a incasso, composto da: miscelatore a incasso con deviatore TIARA, attacco presa acqua a muro con supporto per doccetta, braccio a muro in ottone 30cm, soffione 20x20cm in abs con angoli arrotondati, doccetta in ABS a 3 funzioni con pulsante per il cambio dell'intensità, flessibile 150cm.
Built-in shower set, including: built-in mixer with diverter TIARA, wall water connection with hand shower holder, 30cm brass wall arm, 20x20cm c.p. abs shower head with rounded corners, 3-function abs hand shower with button for switching jet modes, 150cm flexible hose.

CR



CR



15

Set doccia a incasso, composto da: miscelatore a incasso con deviatore su piastra lusso TIARA, asta saliscendi in ottone, attacco presa acqua a muro, braccio a muro in ottone 30cm, soffione ultra piatto lucidato a specchio con angoli arrotondati, doccetta in ABS a 3 funzioni con pulsante per il cambio dell'intensità, flessibile 150cm.
Built-in shower set, including: built-in mixer with diverter on luxury plate TIARA, brass sliding rail, wall water connection, 30cm brass wall arm, ultra-flat shower head in mirror-polished stainless steel with rounded corners, 3-function abs hand shower with button for switching jet modes, 150cm flexible hose.

TA614ZL7720

Con soffione da 20x20 cm.
 With head shower 20x20 cm.

CR

15

TA614ZL7725

Con soffione da 25x25 cm.
 With head shower 25x25 cm.

CR

15

TA614ZL7730

Con soffione da 30x30 cm.
 With head shower 30x30 cm.

CR

15

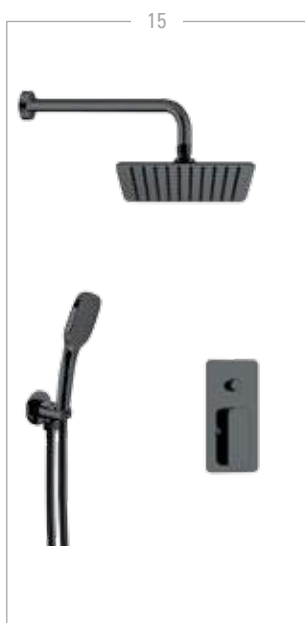
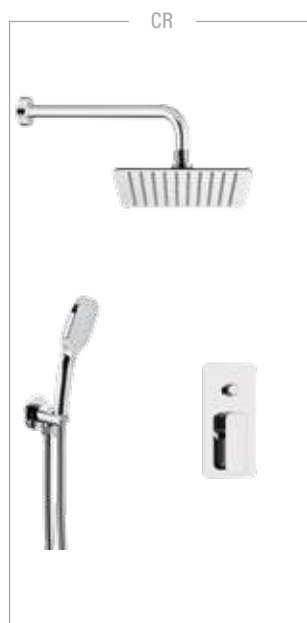

Set doccia a incasso, composto da: miscelatore a incasso con deviatore su piastra lusso TIARA, attacco presa acqua a muro con supporto per doccetta, braccio a muro in ottone 30cm, soffione ultra piatto lucidato a specchio con angoli arrotondati, doccetta in ABS a 3 funzioni con pulsante per il cambio dell'intensità, flessibile 150cm.

Built-in shower set, including: built-in mixer with diverter on luxury plate TIARA, wall water connection with hand shower holder, 30cm brass wall arm, ultra-flat shower head in mirror-polished stainless steel with rounded corners, 3-function abs hand shower with button for switching jet modes, 150cm flexible hose.

TA615ZL7720

Con soffione da 20x20 cm.
With head shower 20x20 cm.

CR	15
----	----

TA615ZL7725

Con soffione da 25x25 cm.
With head shower 25x25 cm.

CR	15
----	----

TA615ZL7730

Con soffione da 30x30 cm.
With head shower 30x30 cm.

CR	15
----	----



Set doccia a incasso, composto da: miscelatore a incasso con deviatore su piastra lusso TIARA, asta saliscendi in ottone, attacco presa acqua a muro, braccio a muro in ottone 30cm, soffione in ottone, doccetta quadrata in ottone a 1 funzione, flessibile 150cm.

Built-in shower set, including: built-in mixer with diverter on luxury plate TIARA, brass sliding rail, wall water connection, 30cm brass wall arm, brass shower head, 1-function squared brass hand shower, 150cm flexible hose.

TA614ZOL

Con soffione da 20x20 cm.
With head shower 20x20 cm.

CR	FIN A	FIN B
----	-------	-------

TA614ZOL93B

Con soffione da 30x30 cm.
With head shower 30x30 cm.

CR	FIN A	FIN B
----	-------	-------



Set doccia a incasso, composto da: miscelatore a incasso con deviatore su piastra lusso TIARA, attacco presa acqua a muro con supporto per doccetta, braccio a muro in ottone 30cm, soffione in ottone, doccetta quadrata in ottone a 1 funzione, flessibile 150cm.

Built-in shower set, including: built-in mixer with diverter on luxury plate TIARA, wall water connection with hand shower holder, 30cm brass wall arm, brass shower head, 1-function squared brass hand shower, 150cm flexible hose.

TA615ZOL

Con soffione da 20x20 cm.
With head shower 20x20 cm.

CR	FIN A	FIN B
----	-------	-------

TA615ZOL93B

Con soffione da 30x30 cm.
With head shower 30x30 cm.

CR	FIN A	FIN B
----	-------	-------



Set doccia a incasso, composto da: miscelatore a incasso su piastra unica con deviatore a 2 vie, presa acqua con doccetta in ottone e flessibile 150 cm, soffione a parete in acciaio inox lucidato a specchio, *Built-in shower set, including: built-in mixer on 1 plate with 2-way diverter, water intake with brass hand-shower and 150cm hose, wall-mounted shower head in mirror-polished stainless steel.*

TA715ZD2562

CR 15



Set doccia a incasso, composto da: miscelatore a incasso su 3 piastre tonde con deviatore a 3 vie, presa acqua con doccetta in ottone e flessibile 150 cm, braccio in ottone 30cm, soffione a pioggia tondo, altezza 3cm, acciaio inox lucidato a specchio, bocca rotonda a incasso con getto a cascata in acciaio inox lucidato a specchio.

NB: miscelatore, deviatore e doccetta hanno piastre esterne separate, ma un'unica parte a incasso.

Built-in shower set, including: built-in mixer on 3 round plates with 3-way diverter, water intake with brass hand-shower and 150cm hose, 30cm brass arm, round shower head, height 3cm, mirror polished stainless steel, round built-in spout with cascade jet in mirror-polished stainless steel.

NB: mixer, diverter and hand-shower intake are on separate plates, but share one single built-in part.

TA715ZD3PLXT8322

Con soffione da Ø 22,5 cm.
With head shower Ø 22,5 cm.

CR 15

TA715ZD3PLXT8332

Con soffione da Ø 32,5 cm.
With head shower Ø 32,5 cm.

CR 15

CUCINA - KITCHEN



TA684

Miscelatore monocomando per lavello, con canna alta girevole e sistema di doccetta monofunzione estraibile.
Single-lever sink mixer with high swivel spout and 1-function pull-out hand shower.

CR FIN A FIN B



TA684DJ

Miscelatore monocomando per lavello, con canna alta girevole e doccetta estraibile a due funzioni. *Single-lever sink mixer with high swivel spout and 2-functions pull-out hand shower.*

CR

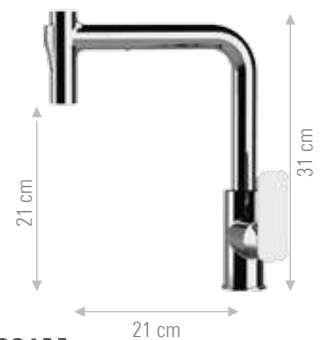

TA681M

Miscelatore monocomando per lavello, con canna alta girevole e doccetta estraibile con impugnatura a martello a due funzioni. *Single-lever sink mixer with high swivel spout and 2-functions pull-out "hammer shaped" handle hand shower.*

CR

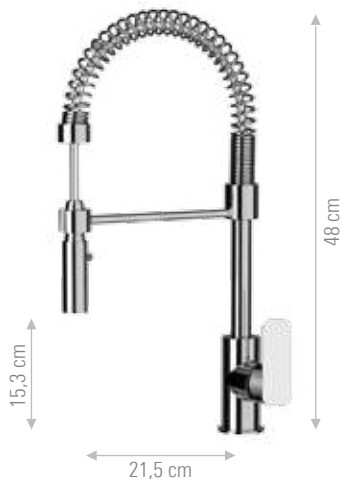

TA689

Miscelatore monocomando lavello a molla con doccetta estraibile dal supporto ed orientabile a due funzioni e cartuccia Ø 35.
Spring single-lever sink mixer with detachable and adjustable 2-functions hand shower and Ø 35 mm cartridge.

CR

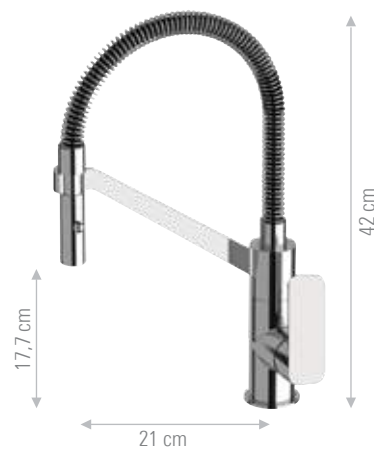

TA233

Miscelatore lavello monocomando con flessibile nero rivestito con molla "fine design" girevole 360°, con doccetta estraibile dl supporto ed orientabile a due funzioni e cartuccia Ø 35.
Single-lever mixer with black flexible hose coated with "fine design" spring, 360° movable, with detachable and adjustable 2-functions hand shower and Ø 35 mm cartridge.

CR

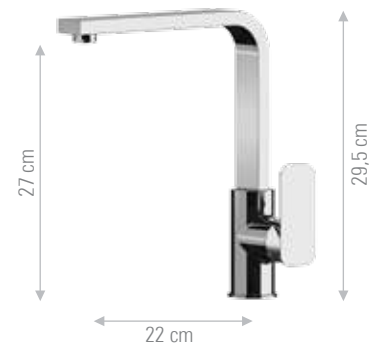

TA618Q

Miscelatore monocomando per lavello, con bocca alta girevole.
Single lever kitchen mixer with high swivel spout.

CR FIN A FIN B



TA618

Miscelatore monocomando monoforo 90°, con canna alta a "U".
Single-lever sink mixer 90°, high "U" spout.

CR FIN A FIN B



TA614B

Miscelatore monocomando per lavello, con bocca alta girevole.
Single-lever one-hole sink mixer, with high movable spout.

CR FIN A FIN B



TA618C

Miscelatore monocomando per lavello/lavabo, con canna corta a "U", tipo lusso.
Single-lever one-hole sink/basin mixer, with short "U" spout, luxury type.

CR FIN A FIN B

ACQUA DEPURATA
PURIFIED WATER

TOUCH-ME



TA614BC

Miscelatore monocomando per lavello, con canna corta girevole.
Single-lever one-hole sink mixer, with short "U" spout, luxury type.

CR FIN A FIN B



TA679DW

Miscelatore lavello a tre vie di ingresso con bocca girevole e due vie d'uscita completamente indipendenti, con selezione acqua potabile tramite la leva.
Three ways inlet single lever sink mixer, with movable spout and two fully independent outlets, with selection for drinking water directly from the lever.

CR FIN A FIN B



TAT618

Miscelatore monocomando lavello, monoforo 90° con canna alta ad "U" dotata di tecnologia Touch-Me con leva laterale e bocca girevole. Dotato di cartuccia Ø35.
Single-lever sink mixer 90°, high "U" spout equipped with Touch-Me system with side lever and movable spout. Equipped with Ø35 cartridge.



CR FIN A FIN B





TOKYO

TOKYO



TK678

La serie TOKYO è la sintesi perfetta di un design che basa la sua natura sull'essenza del minimalismo. L'utilizzo della cartuccia Ø 25 mm rende i corpi dei miscelatori estremamente eleganti e slanciati. Le bocche di erogazione dalla morbida curvatura esaltano la linea accompagnando dolcemente l'acqua nel suo fluire.

.....

CARATTERISTICHE TECNICHE:

La serie è dotata di cartuccia a dischi ceramici Ø25 mm, vasca ed incassi doccia Ø35 mm prodotte da S.T.S.R. – Studio Tecnico Sviluppo e Ricerche - www.stsr.it

The TOKYO Series is the perfect synthesis of a design mainly based on the essence of minimalism. The use of the Ø 25 mm cartridge makes the mixer bodies extremely elegant and willowy. The soft-bending spouts enhance the line by gently following the water on its flow.

.....

TECHNICAL FEATURES:

The series is equipped with ceramic cartridge Ø25 mm, bath and shower mixers Ø35 mm, produced by S.T.S.R. - Research Development Technical Office - www.stsr.it



TK632P15

OIL
OIL BRONZE
OIL BRONZE



TK607OIL

DO
ORO LUCIDO
SHINY GOLD



TK606NDO

15
NERO OPACO
MATT BLACK



TK606N15

AMBITION

TRILOGY

TIARA

TOKYO

SKYLINE

FUSION

DIVA

SPEED

SWING

JAX

OPZIONE LEVA - LEVER OPTION



LAVABI - WASHBASIN MIXERS



TK605

Monocomando lavabo, con scarico.
Single-lever basin mixer, with pop-up waste.

CR FIN A FIN B

YOU AND ME



TK605X

Monocomando lavabo con bocca lunga, con scarico.
Basin mixer with long spout and pop-up waste.

CR FIN A FIN B

YOU AND ME



TK607

Monocomando lavabo alto XL, con scarico click-clack.
XL high basin mixer, with click-clack waste.

CR FIN A FIN B

TK606N

Monocomando lavabo, senza scarico e senza foro sul corpo.
Single-lever basin mixer, without waste and without body hole.

CR FIN A FIN B

YOU AND ME

TK606XN

Monocomando lavabo con bocca lunga, senza scarico e senza foro sul corpo.
Basin mixer with long spout, without waste and without body hole.

CR FIN A FIN B

YOU AND ME

TK607B

Monocomando lavabo alto XL, senza scarico.
XL high basin mixer, without waste.

CR FIN A FIN B



TK655

Miscelatore monocomando a due fori per lavabo. Scarico non incluso.
Two-hole single-lever washbasin mixer. Waste not included.

CR FIN A FIN B



TK655L

Miscelatore monocomando a due fori per lavabo. Scarico non incluso.
Two-hole single-lever washbasin mixer. Waste not included.

CR FIN A FIN B

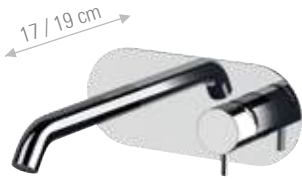

TK632

Miscelatore monocomando a incasso per lavabo, con piastra orizzontale in ottone. Lunghezza bocca: 17 cm.
Single-lever built-it basin mixer, with horizontal brass wall flange. Spout length: 17 cm.

CR FIN A FIN B

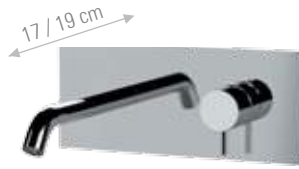

TK632Q

Miscelatore monocomando a incasso per lavabo, con piastra rettangolare in ottone. Lunghezza bocca: 17 cm.
Single-lever built-it basin mixer, with rectangular wall flange in brass. Spout length: 17 cm.

CR FIN A FIN B

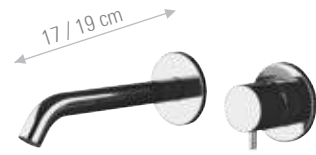

TK632P

Miscelatore monocomando da incasso per lavabo, su doppia piastra. Lunghezza bocca: 17 cm.
Built-in single-lever basin mixer with two separate plates. Spout length: 17 cm.

CR FIN A FIN B

TK632L

Miscelatore monocomando a incasso per lavabo, con piastra orizzontale in ottone cromato. Lunghezza bocca: 19 cm.
Single-lever built-it basin mixer, with horizontal brass wall flange. Spout length: 19 cm.

CR FIN A FIN B

TK632QL

Miscelatore monocomando a incasso per lavabo, con piastra rettangolare in ottone cromato. Lunghezza bocca: 19 cm.
Single-lever built-it basin mixer, with rectangular wall flange in chrome plated brass. Spout length: 19 cm.

CR FIN A FIN B

TK632PL

Miscelatore monocomando da incasso per lavabo, su doppia piastra. Lunghezza bocca: 19 cm.
Built-in single-lever basin mixer on two separate plates. Spout length: 19 cm.

CR FIN A FIN B

LAVABO BOX INCASSO
 BUILT-IN BOX WASHBASIN MIXER

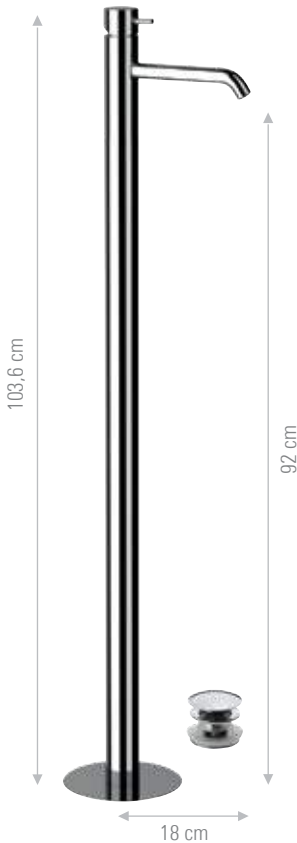

TK688

Miscelatore monocomando lavabo da pavimento con scarico click-clack e troppo pieno.
Single-lever mixer floor mounting with click-clack waste and overflow.

CR FIN A FIN B



TK632KB

Miscelatore monocomando a incasso per lavabo, con piastra in ottone, bocca lunghezza 17 cm, da abbinare al box incasso.
Single-lever built-in basin mixer, with wall flange in brass, spout length 17 cm, to use with the built-in box.

CR FIN A FIN B



DANBOX632

Box incasso per miscelatore monocomando a incasso per lavabo.
Built-in box for single-lever built-in basin mixer.

CR

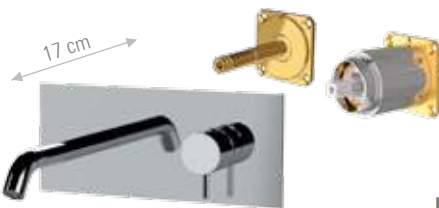

TK632QKB

Con piastra quadrata in ottone.
With square wall flange in brass.

CR FIN A FIN B



DANBOX632

Box incasso per miscelatore monocomando a incasso per lavabo.
Built-in box for single-lever built-in basin mixer.

CR

— BIDET —



TK604

Monocomando bidet, con scarico.
Single-lever bidet mixer, with pop-up waste.

CR FIN A FIN B

TK604BN

Monocomando bidet, senza scarico e senza foro sul corpo.
Single-lever bidet mixer, without waste and without body hole.

CR FIN A FIN B



TK604L

Monocomando bidet modello L, con scarico.
Single-lever bidet mixer, L-model, with pop-up waste.

CR FIN A FIN B

TK604LBN

Monocomando bidet modello L, senza scarico e senza foro sul corpo.
Single-lever bidet mixer, L-model, without waste and without body hole.

CR FIN A FIN B



TK6454DC

Miscelatore incasso per shut-off comprensivo di doccetta shut-off art. 1004DC, supporto doccia-presa acqua, tutto in ottone cromato e flessibile doccia cm 120 in acciaio inox.
Built-in shower mixer set including :shut-off art. 1004DC, shower holder-water punch on flange, all in c.p. brass and shower flexible cm 120 in stainless steel.

CR FIN A FIN B

— BOCHE - SPOUTS —



TK6424DC

Miscelatore incasso per shut-off comprensivo di doccetta shut-off art. 1004DC, supporto doccia-presa acqua su piastra in ottone cromato e flessibile doccia cm 120.
Built-in shower mixer set including shut-off art. 1004DC, shower holder water punch on flange all in c.p. brass and shower flexible cm 120.

CR FIN A FIN B

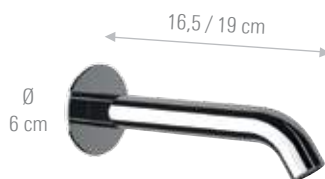

TK4704

Bocca incasso. Lunghezza 16,5cm.
Built-in spout. Lunghezza 16,5cm

CR FIN A FIN B

TK4704L

Bocca incasso. Lunghezza 19cm.
Built-in spout. Length 19cm.

CR FIN A FIN B

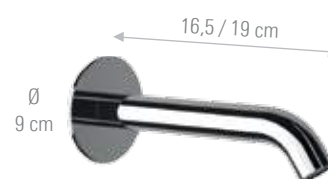

TK4704B

Bocca incasso. Lunghezza 16,5cm.
Built-in spout. Lunghezza 16,5cm

CR FIN A FIN B

TK4704BL

Bocca incasso. Lunghezza 19cm.
Built-in spout. Length 19cm.

CR FIN A FIN B

MISCELATORI VASCA E DOCCIA - SHOWER AND BATH MIXERS



TK611A

Miscelatore doccia esterno, con kit doccia e flessibile da 150 cm.
Exposed shower mixer, with shower kit and 150 cm flexible.

CR FIN A FIN B



TK610

Miscelatore vasca esterno, con kit doccia e flessibile da 150 cm.
Exposed bath mixer, with shower kit and 150 cm flexible.

CR FIN A FIN B



TK611

Miscelatore doccia esterno, senza kit doccia.
Exposed shower mixer, without shower kit.

CR FIN A FIN B



TK600H

Miscelatore vasca esterno, senza kit doccia.
Exposed bath mixer, without shower kit.

CR FIN A FIN B

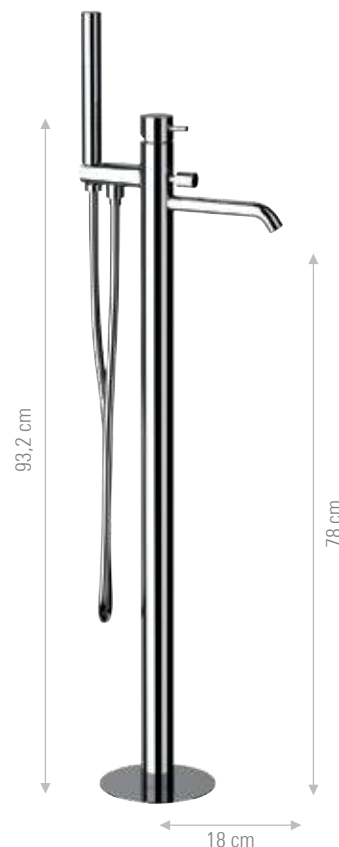

TK678

Miscelatore vasca da pavimento con deviatore e kit doccia.
Free standing bath mixer floor mounting with diverter and shower kit.

CR FIN A FIN B



TK621ZB

Set doccia a incasso, composto da: miscelatore a incasso con deviatore a 2 vie su due piastre TOKYO, attacco presa acqua a muro con supporto per doccia, doccia in ottone a 1 funzione, bocca a incasso 16, 5cm con rosone 90mm, flessibile 150cm.

NB: Le parti a incasso sono indipendenti tra loro e permettono di posizionare i singoli elementi liberamente in base alle esigenze del progetto.

Built-in shower set, including: built-in mixer with 2-way diverter on two plates TOKYO, wall water connection with hand shower holder, 1-function brass hand shower, 16, 5cm built-in spout with 90mm flange, 150cm flexible hose.

NB: The built-in parts are independent of each other and allow the individual elements to be positioned freely according to each project needs.

CR FIN A FIN B



TK625

Miscelatore vasca/doccia e deviatore a 2 vie su piastre separate. NB: Le due parti a incasso sono indipendenti tra loro e permettono di posizionare i singoli elementi liberamente in base alle esigenze del progetto.

Built-in bath/shower mixer with 2-way diverter on double flange. NB: The two built-in parts are independent of each other and allow the individual elements to be positioned freely according to each project needs.

CR FIN A FIN B

□ □ □ 2 VIE - 2-WAY □ □ □



TK700D2Q

Set miscelatore a incasso a 2 vie per vasca/doccia su piastra unica rettangolare, include miscelatore monocomando, deviatore a 2 uscite, bocca a muro. Da completare con una seconda uscita acqua.
2-way built-in mixer set for bathtub / shower on single rectangular plate, including single-lever mixer, 2-way diverter, wall spout. To be completed with a second water outlet.

CR	FIN A	FIN B
----	-------	-------



TK700D2P

Set miscelatore a incasso a 2 vie per vasca/doccia su 3 piastre tonde separate (piastre separate e incasso unico), include: miscelatore monocomando, deviatore a 2 uscite, bocca a muro. Da completare con una seconda uscita.
2-way built-in mixer set for bathtub / shower on 3 separate round plates (separate plates, one single built-in part), including: single-lever mixer, 2-way diverter, wall spout. To be completed with a second water outlet.

CR	FIN A	FIN B
----	-------	-------



TK710D2Q

Set a incasso a 2 vie per vasca, include: miscelatore monocomando, deviatore a 2 uscite e bocca a muro su piastra unica rettangolare; set doccia su piastra quadrata con presa acqua, supporto integrato, doccetta in ottone e flessibile 150cm.
2-way built-in set for bathtub, including: single-lever mixer, 2-way diverter and wall spout on a single rectangular plate; shower set on square plate with water connection, holder, brass handshower and 150cm flexible hose.

CR	FIN A	FIN B
----	-------	-------



TK710D2P

Set a incasso a 2 vie per vasca su piastre tonde separate (3 piastre separate e incasso unico), include: miscelatore monocomando con deviatore a 2 uscite, bocca a muro; set doccia su piastra tonda con presa acqua, supporto, doccetta e flessibile 150cm.
2-way built-in set for bathtub on separate round plates (3 separate plates, one single built-in part), including: single-lever mixer, 2-way diverter, wall spout; Shower set on round plate with water connection, holder, hand shower and 150cm flexible hose.

CR	FIN A	FIN B
----	-------	-------

□ □ □ 3 VIE - 3-WAYS □ □ □



TK700D3Q

Set miscelatore a incasso a 3 vie per vasca/doccia su piastra unica rettangolare, include miscelatore monocomando, deviatore a 3 uscite, bocca a muro. Da completare con una seconda e una terza uscita acqua.
3-way built-in mixer set for bathtub/shower on single rectangular plate, including single-lever mixer, 3-way diverter, wall spout. To be completed with second and third water outlets.

CR	FIN A	FIN B
----	-------	-------

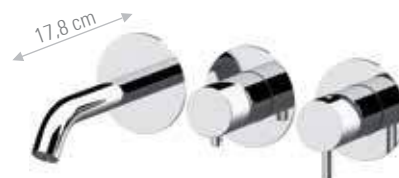

TK700D3P

Set miscelatore a incasso a 3 vie per vasca/doccia su 3 piastre tonde separate (piastre separate e parte a incasso unica), composto da: miscelatore monocomando con deviatore a 3 uscite, bocca a muro. Da completare con una seconda e una terza uscita acqua.
3-way built-in mixer set for bathtub/shower on 3 separate round plates (separate plates, one single built-in part), including: single-lever mixer with 3-way diverter, wall spout. To be completed with second and third water outlets.

CR	FIN A	FIN B
----	-------	-------

INCASSI DOCCIA - BUILT-IN MIXERS

□ □ □ 1 VIA - 1-WAY □ □ □



TK602

Miscelatore incasso per doccia, piastra tonda (articolo COMPLETO).
Built-in shower mixer, rounded plate (COMPLETE item).

CR FIN A FIN B

IN602C35

SOLO parti a incasso
Built-in parts ONLY.

CR FIN A FIN B

TK602EKIT

SOLO parti esterne.
Exposed parts ONLY.

CR FIN A FIN B



TK602Q

Miscelatore incasso per doccia, piastra quadrata (articolo COMPLETO).
Built-in shower mixer, squared plate (COMPLETE item).

CR FIN A FIN B

IN602C35

SOLO parti a incasso
Built-in parts ONLY.

CR FIN A FIN B

TK602QEKIT

SOLO parti esterne.
Exposed parts ONLY.

CR FIN A FIN B

□ □ □ 2 VIE - 2-WAY □ □ □



TK612

Miscelatore incasso con deviatore per vasca/doccia, piastra tonda (articolo COMPLETO).
Built-in bath/shower mixer with diverter, rounded plate (COMPLETE item).

CR FIN A FIN B

IN612C35

SOLO parti a incasso
Built-in parts ONLY.

CR FIN A FIN B

TK612EKIT

SOLO parti esterne.
Exposed parts ONLY.

CR FIN A FIN B



TK612Q

Miscelatore incasso con deviatore per vasca/doccia, piastra quadrata (articolo COMPLETO).
Built-in bath/shower mixer with diverter, squared plate (COMPLETE item).

CR FIN A FIN B

IN612C35

SOLO parti a incasso
Built-in parts ONLY.

CR FIN A FIN B

TK612QEKIT

SOLO parti esterne.
Exposed parts ONLY.

CR FIN A FIN B

AMBITION

TRILOGY

TIARA

TOKYO

SKYLINE

FUSION

DIVA

SPEED

SWING

JAX

□ □ □ 2 VIE - 2-WAY □ □ □



TK612D2

Miscelatore incasso con deviatore a 2 vie per vasca/doccia su piastra lusso ultrapiatta (articolo COMPLETO).
Built-in bath/shower mixer with 2-way diverter on luxury ultraslim plate (COMPLETE item).

CR FIN A FIN B



TK612D2Q

Miscelatore incasso con deviatore a 2 vie per vasca/doccia su piastra lusso squadrata ultrapiatta (articolo COMPLETO).
Built-in bath/shower mixer with 2-way diverter on squared luxury ultraslim plate (COMPLETE item).

CR FIN A FIN B



TK712D2Q

Set miscelatore a incasso a 2 vie per doccia su piastra unica rettangolare, include presa acqua con supporto, doccetta e flessibile 150 cm. Da completare con una 2° uscita.
2-way built-in shower mixer set on a single rectangular plate, including water connection with shower holder, hand shower and 150cm hose. To be completed with a 2nd water outlet.

CR FIN A FIN B



TK712D2P

Set miscelatore a incasso a 2 vie per doccia su 3 piastre tonde separate (parte a incasso unica), include: miscelatore e deviatore a 2 uscite, presa acqua con supporto, doccetta in ottone e flessibile 150 cm. Da completare con una 2° uscita.
2-way built-in shower mixer set on 3 separate round plates (single built-in part), including: mixer and 2-way diverter, water connection with holder, brass hand shower and 150cm flexible hose. To be completed with a 2nd water outlet.

CR FIN A FIN B

□ □ □ 3 VIE - 3-WAY □ □ □



TK612D3

Miscelatore incasso con deviatore a 3 vie per vasca/doccia, 1 entrata e 3 uscite (articolo COMPLETO).
Built-in bath/shower mixer with 3-way diverter, 1 inlet and 3 outlets (COMPLETE item).

CR FIN A FIN B



TK612D3Q

Miscelatore incasso con deviatore a 3 vie per vasca/doccia, 1 entrata e 3 uscite, piastra squadrata (articolo COMPLETO).
Built-in bath/shower mixer with 3-way diverter, 1 inlet and 3 outlets, squared plate (COMPLETE item).

CR FIN A FIN B



TK712D3Q

Set miscelatore a incasso a 3 vie per doccia su piastra unica rettangolare, include: miscelatore, deviatore a 3 uscite, presa acqua con supporto, doccetta in ottone e flessibile 150 cm. Da completare con una 2° ed una 3° uscita.
3-way built-in shower mixer set on a single rectangular plate, including: single-lever mixer, 3-way diverter, water connection with shower holder, brass hand shower and 150cm flexible hose. To be completed with a 2nd and 3rd water outlet.

CR FIN A FIN B



TK712D3P

Set miscelatore a incasso a 3 vie per doccia su 3 piastre tonde separate (parte a incasso unica), include: miscelatore e deviatore a 3 uscite, presa acqua con supporto, doccetta in ottone e flessibile 150cm. Da completare con una 2° ed una 3° uscita.
3-way built-in shower mixer set on 3 separate round plates (single built-in part), including: mixer and 3-way diverter, water connection with holder, brass hand-shower and 150cm flexible hose. To be completed with a 2nd and 3rd water outlet.

CR FIN A FIN B

□ □ □ 4/5 VIE - 4/5-WAY □ □ □



TK612D4

Miscelatore incasso con deviatore a 4 vie per vasca/doccia , 1 entrata e 4 uscite (articolo COMPLETO).

Built-in bath/shower mixer with 4-way diverter, 1 inlet and 4 outlets (COMPLETE item).

CR FIN A FIN B



TK612D4Q

Miscelatore incasso con deviatore a 4 vie per vasca/doccia , 1 entrata e 4 uscite, piastra squadrata (articolo COMPLETO).

Built-in bath/shower mixer with 4-way diverter, 1 inlet and 4 outlets, square plate (COMPLETE item).

CR FIN A FIN B



TK612D5

Miscelatore incasso con deviatore a 5 vie per vasca/doccia , 1 entrata e 5 uscite (articolo COMPLETO).

Built-in bath/shower mixer with 5-way diverter, 1 inlet and 5 outlets (COMPLETE item).

CR FIN A FIN B



TK612D5Q

Miscelatore incasso con deviatore a 5 vie per vasca/doccia , 1 entrata e 5 uscite, piastra squadrata (articolo COMPLETO).

Built-in bath/shower mixer with 5-way diverter, 1 inlet and 5 outlets, squared plate (COMPLETE item).

CR FIN A FIN B

————— KIT WELLNESS - WELLNESS KIT —————



Set doccia a incasso, composto da: miscelatore a incasso con deviatore TOKYO, asta saliscendi in ottone, attacco presa acqua a muro, braccio a muro in ottone 30cm, soffione Ø 20 cm in ottone, doccetta in ottone a 1 funzione, flessibile 150cm.

Built-in shower set, including: built-in mixer with diverter TOKYO, brass sliding rail, wall water connection, 30cm brass wall arm, brass shower head, 1-function brass hand shower, 150cm flexible hose.

TK614Z0CR

Con soffione da Ø20 cm.
With head shower Ø20 cm.

CR FIN A FIN B



Set doccia a incasso, composto da: miscelatore a incasso con deviatore TOKYO, attacco presa acqua a muro con supporto per doccetta, braccio a muro in ottone 30cm, soffione in ottone, doccetta in ottone a 1 funzione, flessibile 150cm.

Built-in shower set, including: built-in mixer with diverter TOKYO, wall water connection with hand shower holder, 30cm brass wall arm, brass shower head, 1-function brass hand shower, 150cm flexible hose.

TK615Z0CR

Con soffione da Ø20 cm.
With head shower Ø20 cm.

CR FIN A FIN B

TK614Z09430CR

Con soffione da Ø30 cm.
With head shower Ø30 cm.

CR FIN A FIN B

TK615Z09430CR

Con soffione da Ø30 cm.
With head shower Ø30 cm.

CR FIN A FIN B



Set doccia a incasso, composto da: miscelatore a incasso con deviatore TOKYO, attacco presa acqua a muro con supporto per doccetta, braccio a muro in ottone 30cm, soffione ultra piatto in acciaio INOX lucidato a specchio, doccetta in ottone a 1 funzione, flessibile 150cm.
Built-in shower set, including: built-in mixer with diverter TOKYO, wall water connection with hand shower holder, 30cm brass wall arm, ultra-flat shower head in mirror-polished stainless steel, 1-function brass hand shower, 150cm flexible hose.

TK615Z7820

Con soffione da Ø20 cm.
 With head shower Ø20 cm.

CR 15

TK615Z7825

Con soffione da Ø25 cm.
 With head shower Ø25 cm.

CR 15

TK615Z7830

Con soffione da Ø30 cm.
 With head shower Ø30 cm.

CR 15

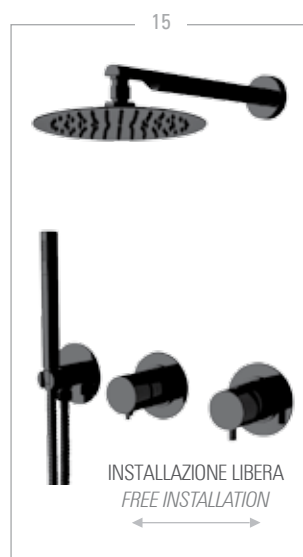

Set doccia a incasso, composto da: miscelatore a incasso su piastra TOKYO, deviatore a 2 vie su piastra, attacco presa acqua a muro con supporto, braccio in ottone 30cm, soffione ultra piatto Ø 20cm in acciaio INOX, doccetta in ottone a 1 funzione, flessibile 150cm. NB: Le parti a incasso sono indipendenti tra loro e permettono di posizionare i singoli elementi liberamente con sequenza e distanze diverse in base alle esigenze del progetto.

Built-in shower set, including: TOKYO built-in mixer on plate, 2-way diverter on plate, water connection with hand shower holder, 30cm brass arm, ultra flat shower head Ø 20cm in stainless steel, 1 function brass hand shower, flexible 150cm. NB: built-in parts are independent of each other and allow you to freely position the individual elements with different sequences and distances according to each project needs.

TK625Z7820

Con soffione da Ø20 cm.
 With head shower Ø20 cm.

CR 15

TK625Z7825

Con soffione da Ø25 cm.
 With head shower Ø25 cm.

CR 15

TK625Z7830

Con soffione da Ø30 cm.
 With head shower Ø30 cm.

CR 15



Set doccia a incasso, composto da: miscelatore a incasso su 3 piastre tonde con deviatore a 2 vie, presa acqua con doccetta in ottone e flessibile 150 cm, braccio a muro in ottone 30cm, soffione ultra piatto in acciaio INOX lucidato a specchio. NB: miscelatore, deviatore e doccetta hanno piastre esterne separate, ma un'unica parte a incasso.

Built-in shower set, including: built-in mixer on 3 round plates with 2-way diverter, water intake with brass hand-shower and 150cm hose, 30cm brass wall arm, ultra-flat shower head in mirror-polished stainless. NB: mixer, diverter and hand-shower intake are on separate plates, but share one single built-in part.

TK715ZD2P7820

Con soffione da Ø20 cm.
 With head shower Ø20 cm.

CR 15

TK715ZD2P7825

Con soffione da Ø25 cm.
 With head shower Ø25 cm.

CR 15

TK715ZD2P7830

Con soffione da Ø30 cm.
 With head shower Ø30 cm.

CR 15



Set doccia a incasso, composto da: miscelatore a incasso su 3 piastre tonde con deviatore a 3 vie, presa acqua con doccetta in ottone e flessibile 150 cm, braccio a muro in ottone 30cm, soffione ultra piatto in acciaio INOX lucidato a specchio, bocca rotonda a incasso con getto a cascata in acciaio inox lucidato a specchio.

NB: miscelatore, deviatore e doccetta hanno piastre esterne separate, ma un'unica parte a incasso.

Built-in shower set, including: built-in mixer on 3 round plates with 3-way diverter, water intake with brass hand-shower and 150cm hose, 30cm brass wall arm, ultra-flat shower head in mirror-polished stainless steel, round built-in spout with cascade jet in mirror-polished stainless steel.
NB: mixer, diverter and hand-shower intake are on separate plates, but share one single built-in part.

TK715ZD3PXT7820

Con soffione da Ø20 cm.
With head shower Ø20 cm.

CR 15

TK715ZD3PXT7825

Con soffione da Ø25 cm.
With head shower Ø25 cm.

CR 15

TK715ZD3PXT7830

Con soffione da Ø30 cm.
With head shower Ø30 cm.

CR 15

— CUCINA - KITCHEN —



TX684

Miscelatore monocomando per lavello con canna alta girevole e sistema di doccetta monofunzione estraibile.

Single-lever sink mixer with high movable spout and single-function system pull-out hand shower.

CR FIN A FIN B



TX684DJ

Miscelatore monocomando per lavello con canna alta girevole e doccetta estraibile a due funzioni.

Single-lever sink mixer with high movable spout and 2-functions pull-out hand shower.

CR



TX681M

Miscelatore monocomando per lavello con canna alta girevole e doccetta estraibile a due funzioni.

Single-lever sink mixer with high movable spout and 2-functions pull-out hand shower.

CR



TX618

Miscelatore monocomando monoforo per lavello con canna alta a "U" girevole.

Single-lever sink mixer, high movable "U" spout.

CR FIN A FIN B



TX618C

Miscelatore monocomando per lavello/lavabo, con canna corta a "U", tipo lusso.

Single-lever one-hole sink/basin mixer, with short "U" spout, luxury type.

CR FIN A FIN B





SKYLINE

SKYLINE



SK678

La Collezione di miscelatori SKYLINE sviluppa un tema di essenzialità nelle linee e una precisione geometrica nelle sue forme totalmente squadrate. Una totale robotizzazione del ciclo produttivo assicura un alto livello di qualità ed attenzione al dettaglio.

CARATTERISTICHE TECNICHE:

La serie è dotata di cartuccia a dischi ceramici Ø 25 mm, tranne gli incassi che utilizzano una cartuccia a dischi ceramici Ø 35 mm. Cartucce prodotte da S.T.S.R. – Studio Tecnico Sviluppo e Ricerche, www.stsr.it

SKYLINE mixers collection develops a theme of essentiality in the lines and a geometric precision in its totally square shapes. A total robotization of the production cycle ensures a high level of quality and attention to detail.

TECHNICAL FEATURES:

The series is equipped with ceramic cartridge Ø25 mm, except for built-in items that use ceramic cartridge Ø35 mm. Cartridges are produced by S.T.S.R. - Research Development Technical Office, www.stsr.it



SK632

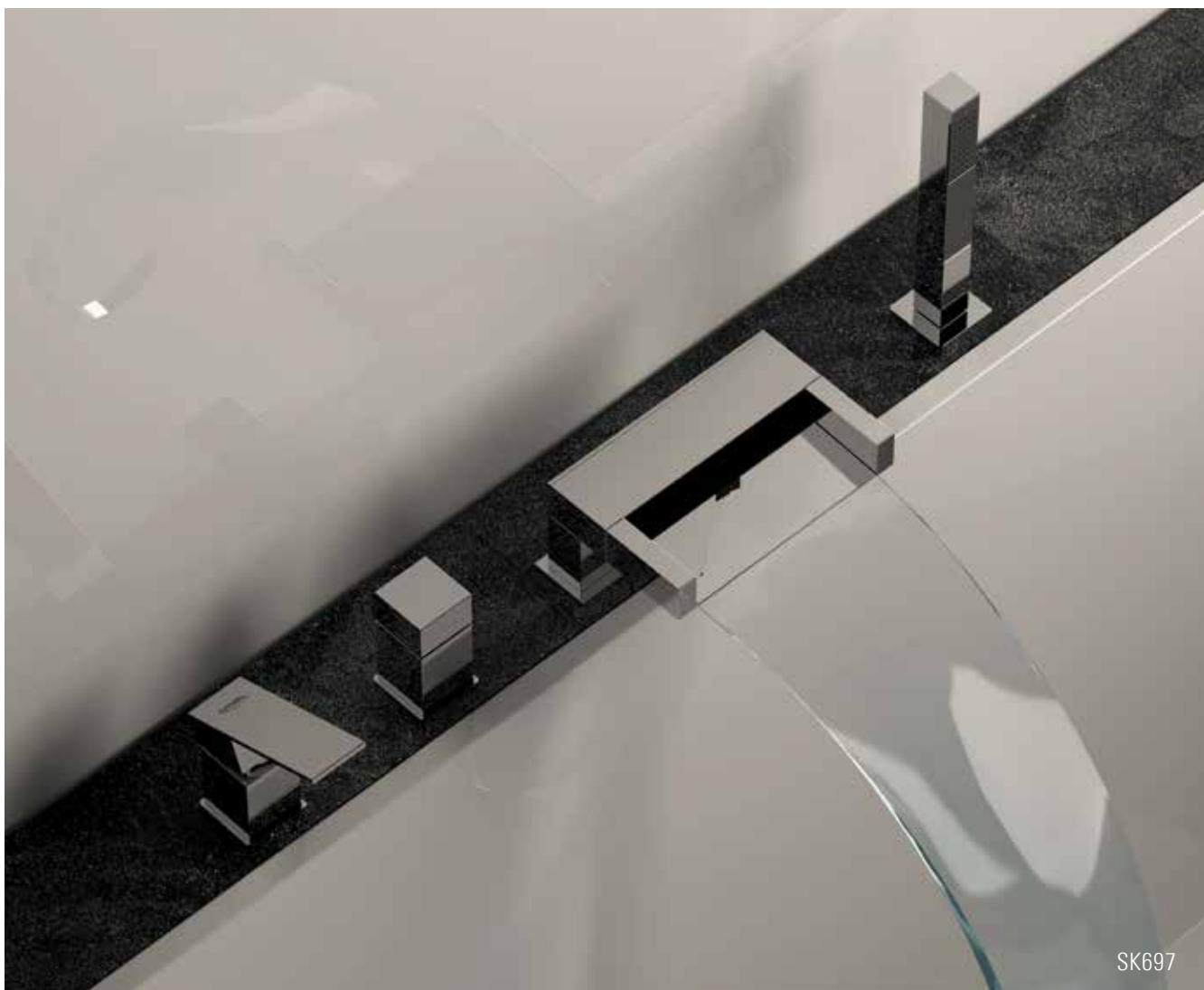

SK697

AMBITION

TRILOGY

TIARA

TOKYO

SKYLINE

FUSION

DIVA

SPEED

SWING

JAX

14

BIANCO OPACO

MATT WHITE



SK607X14

DO
ORO LUCIDO
SHINY GOLD



SK655DO

15
NERO OPACO
MATT BLACK



SK65515

AMBITION

TRIOLOGY

TIARA

TOKYO

SKYLINE

FUSION

DIVA

SPEED

SWING

JAX

LAVABI - WASHBASIN MIXERS



SK605

Monocomando lavabo, con scarico.
Single-lever basin mixer, with pop-up waste.

CR FIN A FIN B

YOU AND ME



SK605L

Monocomando lavabo L, con scarico.
L single-lever basin mixer, with pop-up waste.

CR FIN A FIN B

YOU AND ME



SK607

Monocomando lavabo alto, con scarico click-clack.
High single-lever basin mixer, with click-clack waste.

CR FIN A FIN B

SK606

Monocomando lavabo, senza scarico.
Single-lever basin mixer, without waste.

CR FIN A FIN B

YOU AND ME

SK606L

Monocomando lavabo L, senza scarico.
L single-lever basin mixer, without waste.

CR FIN A FIN B

YOU AND ME

SK607B

Monocomando lavabo alto, senza scarico click-clack.
High single-lever basin mixer, without click-clack waste.

CR FIN A FIN B



SK607X

Monocomando lavabo alto XL con scarico click-clack.
High XL basin mixer with click-clack waste.

CR FIN A FIN B



SK607XL

Monocomando lavabo alto XXL con scarico click-clack.
High XXL basin mixer with click-clack waste.

CR FIN A FIN B

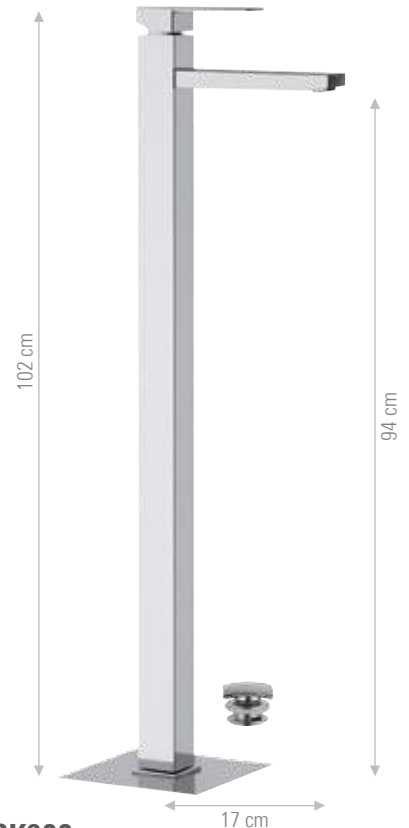

SK688

Miscelatore monocomando lavabo da pavimento con click-clack e troppo pieno.
Single-lever mixer floor mounting with click-clack and overflow.

CR FIN A FIN B



SK622

Miscelatore lavabo da incasso.
Concealed washbasin mixer.

CR FIN A FIN B

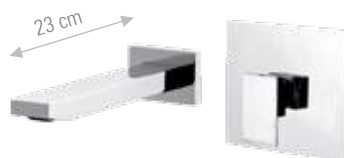

SK622L

Miscelatore lavabo da incasso.
Concealed washbasin mixer.

CR FIN A FIN B



SK605R

Miscelatore monocomando per lavabo con canna corta a "U" girevole e scarico click-clack.
Single-lever one-hole sink mixer with short "U" movable spout and click-clack waste.

CR FIN A FIN B

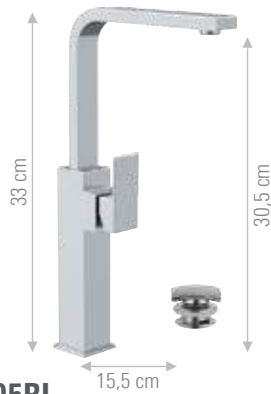

SK605RL

Miscelatore monocomando alto per lavabo con canna corta a "U" girevole e scarico click-clack.
High single-lever one-hole sink mixer with short "U" movable spout and click-clack waste.

CR FIN A FIN B



SK605RXL

Miscelatore monocomando alto per lavabo con canna lunga "U" girevole e scarico click-clack.
High single-lever one-hole sink mixer with long "U" movable spout and click-clack waste.

CR FIN A FIN B



SK655

Miscelatore monocomando a due fori per lavabo. Scarico non incluso.
Two-hole single-lever washbasin mixer. Waste not included.

CR FIN A FIN B



SK632

Miscelatore monocomando a incasso per lavabo, con piastra rettangolare.
 Lunghezza bocca: 20 cm.
Single-lever built-in basin mixer, with rectangular wall flange. Spout length: 20 cm.

CR FIN A FIN B

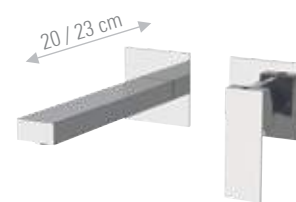

SK632P

Miscelatore monocomando da incasso per lavabo, su doppia piastra.
 Lunghezza bocca: 20 cm.
Built-in single-lever basin mixer with two separate plates. Spout length: 20 cm.

CR FIN A FIN B

SK632L

Miscelatore monocomando a incasso per lavabo, con piastra rettangolare.
 Lunghezza bocca: 23 cm.
Single-lever built-in basin mixer, with rectangular wall flange. Spout length: 23 cm.

CR FIN A FIN B

SK632PL

Miscelatore monocomando da incasso per lavabo, su doppia piastra.
 Lunghezza bocca: 23 cm.
Built-in single-lever basin mixer with two separate plates. Spout length: 23 cm.

CR FIN A FIN B

LAVABO BOX INCASSO - BUILT-IN BOX WASHBASIN MIXER



SK632KB

Miscelatore monocomando a incasso per lavabo, con piastra in ottone, bocca lunghezza 20 cm, da abbinare al box incasso.
Single-lever built-in basin mixer, with wall flange in brass, spout length 20 cm, to use with the built-in box.

CR FIN A FIN B



SK632LKB

Miscelatore monocomando a incasso per lavabo, con piastra in ottone, bocca lunghezza 23 cm, da abbinare al box incasso.
Single-lever built-in basin mixer, with wall flange in brass, spout length 23 cm, to use with the built-in box.

CR FIN A FIN B



DANBOX632

Box incasso per miscelatore monocomando a incasso per lavabo.
Built-in box for single-lever built-in basin mixer.

CR

AMBITION

TRILOGY

TIARA

TOKYO

SKYLINE

FUSION

DIVA

SPEED

SWING

JAX

— BIDET —



SK604

Miscelatore bidet, con scarico.
Bidet mixer, with pop-up waste.

CR FIN A FIN B



SK604B

Miscelatore bidet, senza scarico.
Bidet mixer, without pop-up waste.

CR FIN A FIN B



SK645

Set shut-off comprensivo di: miscelatore a incasso su piastra in ottone con supporto e presa acqua integrati, doccetta shut-off art. 1010DC e flessibile doccia cm 120.
Built-in shut-off set including: built-in mixer on brass plate with integrated holder and water connection, shut-off handshower art 1010DC and shower hose 120 cm.

CR FIN A FIN B



SK642

Miscelatore incasso per shut-off con doccetta shut-off, supporto doccia, presa acqua.
Built-in shut-off mixer set with shut-off, shower holder, water punch.

CR FIN A FIN B



SK646

Miscelatore incasso per shut-off.
Built-in shut-off mixer.

CR FIN A FIN B

— BOCCHE - SPOUTS —



SK4702

Bocca incasso con deviatore integrato 18 cm.
Built-in spout with diverter 18 cm.

CR FIN A FIN B



C4705Q

Bocca bordo vasca a cascata.
Waterfall built-in spout.

CR FIN A FIN B



SK4704

Bocca incasso. Lunghezza bocca: 17 cm.
Built-in spout. Spout length: 17 cm.

CR FIN A FIN B



F4705Q

Bocca bordo vasca con effetto multigetto.
Spout with multijet effect for deck bath/shower mixer.

CR FIN A FIN B



CA4704

Bocca incasso a cascata.
Built-in spout with waterfall jet.

CR FIN A FIN B

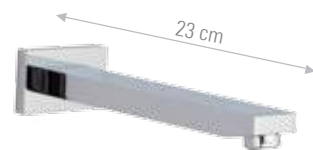

SK4704L

Bocca incasso. Lunghezza bocca: 23 cm.
Built-in spout. Spout length: 23 cm.

CR FIN A FIN B

MISCELATORI VASCA E DOCCIA - SHOWER AND BATH MIXERS

AMBITION

TRILOGY

TIARA

TOKYO

SKYLINE

FUSION

DIVA

SPEED

SWING

JAX

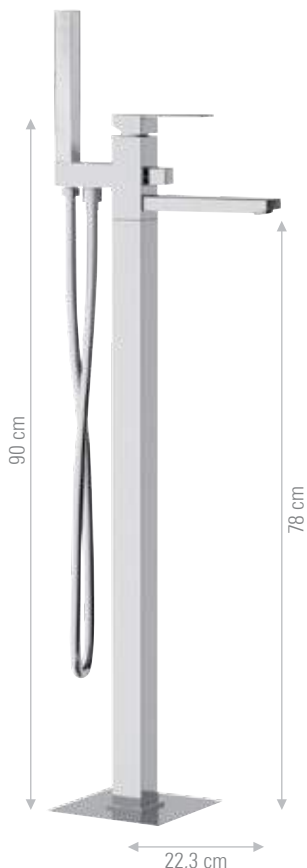

SK678

Miscelatore vasca da pavimento con deviatore e kit doccia.
Free standing bath mixer floor mounting with diverter and shower kit.

CR FIN A FIN B



SK652

Set a incasso per vasca composto da: miscelatore monocomando per vasca da incasso su piastra rettangolare, bocca cm 18 con deviatore e kit doccia a 1 funzione.
Built-in set for bathtub including: built-in single-lever mixer on rectangular plate, 18 cm long spout with diverter and 1-function shower kit.

CR FIN A FIN B



SK600H

Miscelatore vasca esterno senza doccia.
Exposed bath/shower mixer without shower.

CR FIN A FIN B



SK610

Miscelatore vasca esterno, con kit doccia, flessibile 150 cm.
Exposed bath mixer, with shower kit, flexible 150 cm.

CR FIN A FIN B

SK600

Monocomando vasca duplex esterno, con flessibile cm.120 e supporto e doccetta
Exposed bath-shower single-lever mixer, automatic diverter, with flexible cm.120

CR FIN A FIN B



A345495

Saliscendi completamente in ottone cromato quadro con doccetta ad 1 funzione.
C.p. brass square sliding rail set with 1 function handshower.

CR FIN A FIN B

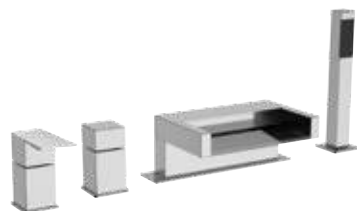

SK697

Set per bordo vasca con miscelatore, deviatore bocca a cascata e doccetta estraibile ad 1 funzione.
Deck bath set including mixer, diverter, waterfall spout and pull-out 1-function shower kit.

CR FIN A FIN B



SK699

Set per bordo vasca con miscelatore, deviatore bocca multigetto e doccetta estraibile ad 1 funzione.
Deck bath set including mixer, diverter, multi-jet spout and pull-out 1-function shower kit.

CR FIN A FIN B



SK691

Set per bordo vasca con miscelatore, deviatore e doccetta estraibile ad 1 funzione.
Deck bath set including mixer, diverter, and pull-out 1-function shower kit.

CR FIN A FIN B



SK611A

Monocomando doccia esterno, con kit doccia.
Exposed shower mixer, with shower mixer.

CR FIN A FIN B



SK611

Monocomando doccia esterno, senza kit doccia.
Exposed shower mixer, without shower mixer.

CR FIN A FIN B



SK611Z

Monocomando doccia esterno con attacco 3/4 M per colonna.
Exposed shower mixer with connection 3/4 M for columns.

CR FIN A FIN B

□ □ □ 2 VIE - 2-WAY □ □ □



SK700D2

Set miscelatore a incasso a 2 vie per vasca/doccia su piastra unica rettangolare, include miscelatore monocomando, deviatore a 2 uscite, bocca a muro. Da completare con una seconda uscita acqua.
2-way built-in mixer set for bathtub / shower on single rectangular plate, including single-lever mixer, 2-way diverter, wall spout. To be completed with a second water outlet.

CR FIN A FIN B



SK710D2

Set a incasso a 2 vie per vasca, include: miscelatore monocomando, deviatore a 2 uscite e bocca a muro su piastra unica rettangolare; set doccia su piastra quadrata con presa acqua, supporto integrato, doccetta in ottone e flessibile 150cm.
2-way built-in set for bathtub, including: single-lever mixer, 2-way diverter and wall spout on a single rectangular plate; shower set on square plate with water connection, holder, brass handshower and 150cm flexible hose.

CR FIN A FIN B

□ □ □ 3 VIE - 3-WAY □ □ □



SK700D3

Set miscelatore a incasso a 3 vie per vasca/doccia su piastra unica rettangolare, include miscelatore monocomando, deviatore a 3 uscite, bocca a muro. Da completare con una seconda e una terza uscita acqua.
3-way built-in mixer set for bathtub/shower on single rectangular plate, including single-lever mixer, 3-way diverter, wall spout. To be completed with second and third water outlets.

CR FIN A FIN B

INCASSI DOCCIA - BUILT-IN MIXERS

□ □ □ 1 VIA - 1-WAY □ □ □



SK602G

Miscelatore incasso per doccia (articolo COMPLETO).
Built-in shower mixer (COMPLETE item).

CR FIN A FIN B

IN602C35

SOLO parti a incasso
Built-in parts ONLY.

CR FIN A FIN B

SK602GEKIT

SOLO parti esterne.
Exposed parts ONLY.

CR FIN A FIN B



SK602

Miscelatore incasso per doccia, con piastra lusso (articolo COMPLETO).
Built-in shower mixer on luxury plate (COMPLETE item).

CR FIN A FIN B

IN602C35

SOLO parti a incasso
Built-in parts ONLY.

CR FIN A FIN B

SK602EKIT

SOLO parti esterne.
Exposed parts ONLY.

CR FIN A FIN B



SK602B

Miscelatore incasso per doccia, con piastra quadrata (articolo COMPLETO).
Built-in shower mixer on square plate (COMPLETE item).

CR FIN A FIN B

IN602C35

SOLO parti a incasso
Built-in parts ONLY.

CR FIN A FIN B

SK602BEKIT

SOLO parti esterne.
Exposed parts ONLY.

CR FIN A FIN B

□ □ □ 2 VIE - 2-WAY □ □ □



SK612G

Miscelatore incasso con deviatore per vasca/doccia (articolo COMPLETO).
Built-in bath/shower mixer with diverter (COMPLETE item).

CR FIN A FIN B

IN612C35

SOLO parti a incasso
Built-in parts ONLY.

CR FIN A FIN B

SK612GEKIT

SOLO parti esterne.
Exposed parts ONLY.

CR FIN A FIN B

AMBITION

TRILOGY

TIARA

TOKYO

SKYLINE

FUSION

DIVA

SPEED

SWING

JAX



SK612

Miscelatore incasso con deviatore per vasca/doccia con piastra lusso (articolo COMPLETO).
Built-in bath/shower mixer with diverter on luxury plate (COMPLETE item).

CR FIN A FIN B

IN612C35

SOLO parti a incasso
Built-in parts ONLY.

CR FIN A FIN B

SK612EKIT

SOLO parti esterne.
Exposed parts ONLY.

CR FIN A FIN B



SK612B

Miscelatore incasso con deviatore per vasca/doccia, con piastra quadrata. (articolo COMPLETO).
Built-in bath/shower mixer with diverter, on square plate (COMPLETE item).

CR FIN A FIN B

IN612C35

SOLO parti a incasso
Built-in parts ONLY.

CR FIN A FIN B

SK612BEKIT

SOLO parti esterne.
Exposed parts ONLY.

CR FIN A FIN B



SK612D2

Miscelatore incasso con deviatore a 2 vie per vasca/doccia su piastra lusso ultrapiatta (articolo COMPLETO).
Built-in bath/shower mixer with 2-way diverter on luxury ultraslim plate (COMPLETE item).

CR FIN A FIN B



SK712D2

Set miscelatore a incasso a 2 vie per doccia su piastra unica rettangolare, include presa acqua con supporto, doccia e flessibile 150 cm. Da completare con una 2° uscita.
2-way built-in shower mixer set on a single rectangular plate, including water connection with shower holder, hand shower and 150cm hose. To be completed with a 2nd water outlet.

CR FIN A FIN B



□ □ □ 3 VIE - 3-WAY □ □ □



SK612D3

Miscelatore incasso con deviatore a 3 vie per vasca/doccia , 1 entrata e 3 uscite (articolo COMPLETO).
Built-in bath/shower mixer with 3-way diverter, 1 inlet and 3 outlets (COMPLETE item).

SK712D3

Set miscelatore a incasso a 3 vie per doccia su piastra unica rettangolare, include: miscelatore, deviatore a 3 uscite, presa acqua con supporto, doccetta in ottone e flessibile 150 cm. Da completare con una 2° ed una 3° uscita.
3-way built-in shower mixer set on a single rectangular plate, including: single-lever mixer, 3-way diverter, water connection with shower holder, brass hand shower and 150cm flexible hose. To be completed with a 2nd and 3rd water outlet.

CR FIN A FIN B

CR FIN A FIN B



□ □ □ 4/5 VIE - 4/5WAY □ □ □



SK612D4

Miscelatore incasso con deviatore a 4 vie per vasca/doccia , 1 entrata e 4 uscite (articolo COMPLETO).
Built-in bath/shower mixer with 4-way diverter, 1 inlet and 4 outlets (COMPLETE item).

SK612D5

Miscelatore incasso con deviatore a 5 vie per vasca/doccia , 1 entrata e 5 uscite (articolo COMPLETO).
Built-in bath/shower mixer with 5-way diverter, 1 inlet and 5 outlets (COMPLETE item).

CR FIN A FIN B

CR FIN A FIN B

COLONNE DOCCIA - SHOWER COLUMN



SK636Q

Set colonna doccia, composto da: miscelatore esterno per colonna SKYLINE, colonna doccia squadrata con deviatore, flessibile doccia 150cm, soffione 24x14cm rettangolare in ottone, doccetta quadrata in ottone a 1 funzione,
Shower column set, including: exposed mixer for column SKYLINE, squared column with diverter and 150cm flexible hose, 24x14cm rectangular brass shower head, 1-function squared brass hand shower.

CR FIN A FIN B



W4436R

Set colonna doccia, composto da: gruppo doccia esterno per colonna a due maniglie, colonna rettangolare con deviatore e flessibile 150cm, soffione 24x14cm rettangolare in ottone, doccetta rettangolare in ottone a 1 funzione,
Shower column set, including: exposed mixer for column dual control, rectangular column with diverter and 150cm flexible hose, 24x14cm rectangular brass shower head, 1-function rectangular brass hand shower.

CR FIN A FIN B

KIT WELLNESS - WELLNESS KIT



Set doccia a incasso, composto da: miscelatore a incasso con deviatore SKYLINE, asta saliscendi rettangolare in ottone, attacco presa acqua a muro, braccio a muro rettangolare in ottone 30cm, soffione ultra piatto in acciaio INOX lucidato a specchio, doccetta quadrata in ottone a 1 funzione, flessibile 150cm.

Built-in shower set, including: built-in mixer with diverter SKYLINE, rectangular brass sliding rail, wall water connection, 30cm rectangular brass wall arm, ultra-flat shower head in mirror-polished stainless steel, 1-function squared brass hand shower, 150cm flexible hose.

SK614Z7920

Con soffione da 20x20 cm.

With head shower 20x20 cm.

CR 15

SK614Z7925

Con soffione da 25x25 cm.

With head shower 25x25 cm.

CR 15

SK614Z7930

Con soffione da 30x30 cm.

With head shower 30x30 cm.

CR 15

SK614Z7940

Con soffione da 40x40 cm.

With head shower 40x40 cm.

Braccio a parete 40 cm. Wall arm 40 cm.

CR 15



Set doccia a incasso, composto da: miscelatore a incasso con deviatore SKYLINE, attacco presa acqua a muro con supporto snodato per doccetta, braccio a muro rettangolare in ottone 30cm, soffione ultra piatto in acciaio INOX lucidato a specchio, doccetta quadrata in ottone a 1 funzione, flessibile 150cm.

Built-in shower set, including: built-in mixer with diverter SKYLINE, wall water connection with adjustable hand shower holder, 30cm rectangular brass wall arm, ultra-flat shower head in mirror-polished stainless steel, 1-function squared brass hand shower, 150cm flexible hose.

SK615Z7920

Con soffione da 20x20 cm.

With head shower 20x20 cm.

CR 15

SK615Z7925

Con soffione da 25x25 cm.

With head shower 25x25 cm.

CR 15

SK615Z7930

Con soffione da 30x30 cm.

With head shower 30x30 cm.

CR 15

SK615Z7940

Con soffione da 40x40 cm.

With head shower 40x40 cm.

Braccio a parete 40 cm. Wall arm 40 cm.

CR 15



SK615ZSS

Set doccia a incasso, composto da: miscelatore a incasso con deviatore SKYLINE, attacco presa acqua a muro con supporto snodato per doccetta, soffione a parete in acciaio inox lucidato a specchio, doccetta quadrata in ottone a 1 funzione, flessibile 150cm.

Built-in shower set, including: built-in mixer with diverter SKYLINE, wall water connection with adjustable hand shower holder, wall-mounted shower head in mirror-polished stainless steel, 1-function squared brass hand shower, 150cm flexible hose.

CR 15



SK614ZSSCA

Set doccia a incasso, composto da: miscelatore a incasso con deviatore a 3vie e 7 posizioni SKYLINE, asta saliscendi rettangolare in ottone, attacco presa acqua a muro, soffione a parete in acciaio inox lucidato a specchio con getto pioggia e cascata, doccetta quadrata in ottone a 1 funzione, flessibile 150cm.

Built-in shower set, including: built-in mixer with 3-way 7-position diverter SKYLINE, rectangular brass sliding rail, wall water connection, wall-mounted shower head in mirror-polished stainless steel with rain and waterfall jets, 1-function squared brass hand shower, 150cm flexible hose.



SK614ZSS

Set doccia a incasso, composto da: miscelatore a incasso con deviatore SKYLINE SK612, asta saliscendi rettangolare in ottone, attacco presa acqua a muro, soffione a parete in acciaio inox lucidato a specchio, doccetta quadrata in ottone a 1 funzione, flessibile 150cm.

Built-in shower set, including: built-in mixer with diverter SKYLINE SK612, rectangular brass sliding rail, wall water connection, wall-mounted shower head in mirror-polished stainless steel, 1-function squared brass hand shower, 150cm flexible hose.



SK615ZSSCA

Set doccia a incasso, composto da: miscelatore a incasso con deviatore a 3vie e 7 posizioni SKYLINE, attacco presa acqua a muro con supporto snodato per doccetta, soffione a parete in acciaio inox lucidato a specchio con getto pioggia e cascata, doccetta quadrata in ottone a 1 funzione, flessibile 150cm.

Built-in shower set, including: built-in mixer with 3-way 7-position diverter SKYLINE, wall water connection with adjustable hand shower holder, wall-mounted shower head in mirror-polished stainless steel with rain and waterfall jets, 1-function squared brass hand shower, 150cm flexible hose. single lever built-in shower mixer.



Set doccia a incasso, composto da: miscelatore a incasso su piastra unica con deviatore a 2 vie, presa acqua con doccetta in ottone e flessibile 150 cm, braccio a muro rettangolare in ottone 30cm, soffione in ottone.

Built-in shower set, including: built-in mixer on 1 plate with 2-way diverter, water intake with brass hand-shower and 150cm hose, 30cm rectangular brass wall arm, brass shower head.

SK715ZD2590

Con soffione da 20x20 cm.
With head shower 20x20 cm.



SK715ZD293B

Con soffione da 30x30 cm.
With head shower 30x30 cm.



Set doccia a incasso, composto da: miscelatore a incasso su piastra unica con deviatore a 3 vie, presa acqua con doccetta in ottone e flessibile 150 cm, soffione a parete in acciaio inox lucidato a specchio con getto pioggia e cascata.

Built-in shower set, including: built-in mixer on 1 plate with 3-way diverter, water intake with brass hand-shower and 150cm hose, wall-mounted shower head in mirror-polished stainless steel with rain and waterfall jets.

SK715ZD32CA





Set doccia a incasso, composto da: miscelatore a incasso con deviatore a 3vie e 7 posizioni SKYLINE, attacco presa acqua a muro con supporto snodato per doccetta, braccio a muro rettangolare in ottone 30cm, soffione ultra piatto in acciaio INOX lucidato a specchio, doccetta quadrata in ottone a 1 funzione, 6 getti a incasso, flessibile 150cm.

Built-in shower set, including: built-in mixer with 3-way 7-position diverter SKYLINE, wall water connection with adjustable hand shower holder, 30cm rectangular brass wall arm, ultra-flat shower head in mirror-polished stainless steel, 1-function squared brass hand shower, 6 built-in jets, 150cm flexible hose.

SK616Z7920

Con soffione da 20x20 cm.
With head shower 20x20 cm.

CR 15

SK616Z7925

Con soffione da 25x25 cm.
With head shower 25x25 cm.

CR 15

SK616Z7930

Con soffione da 30x30 cm.
With head shower 30x30 cm.

CR 15

SK616Z7940

Con soffione da 40x40 cm.
With head shower 40x40 cm.

CR 15

Braccio a parete 40 cm. Wall arm 40 cm.

DOPPIO COMANDO - DUAL CONTROL



W5116S

Monoforo lavabo con bocca corta e girevole e scarico.
One hole washbasin with short and swiveling spout and pop-up waste.

CR FIN A FIN B

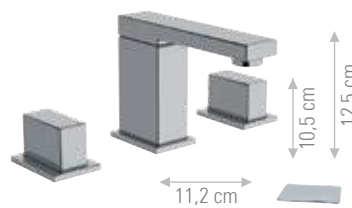

W5003

Batteria lavabo con scarico.
Washbasin set with pop-up waste.

CR FIN A FIN B



W5022

Batteria lavabo da incasso.
Concealed basin mixer.

CR FIN A FIN B



W5116

Monoforo lavabo con bocca alta girevole, con scarico.
One hole high washbasin mixer with high swiveling spout, with pop-up waste.

CR FIN A FIN B



W5116CC

Monoforo lavabo con bocca alta girevole, con scarico click-clack e troppo pieno.
One hole high washbasin mixer with high swivel spout, with click-clack waste and overflow.

CR FIN A FIN B



W5116LS

Monoforo lavabo con base alta, bocca corta girevole e scarico.
One hole washbasin mixer with high base, short and swiveling spout and pop-up waste.

CR FIN A FIN B



W4440

Batteria vasca incasso con set doccia.
Built-in bathtub mixer with shower kit.

CR FIN A FIN B



W4454

Rubinetto doccia incasso 1/2".
Built-in right valve 1/2".

CR FIN A FIN B



W4441

Set doccia a incasso, composto da: batteria a incasso con doppio comando caldo e freddo e deviatore SKYLINE, attacco presa acqua a muro con supporto snodato per doccetta, braccio a muro rettangolare in ottone 30cm, soffione 24x14cm rettangolare in ottone, doccetta quadrata in ottone a 1 funzione, flessibile 150cm.
Built-in shower set, including: built-in 2-handle hot/cold mixer with diverter SKYLINE, wall water connection with adjustable hand shower holder, 30cm rectangular brass wall arm, 24x14cm rectangular brass shower head, 1-function squared brass hand shower, 150cm flexible hose.

CR FIN A FIN B



W4442

Set doccia a incasso, composto da: batteria a incasso con doppio comando caldo e freddo e deviatore SKYLINE, asta saliscendi rettangolare in ottone, attacco presa acqua a muro, braccio a muro rettangolare in ottone 30cm, soffione 24x14cm rettangolare in ottone, doccetta rettangolare in ottone a 1 funzione, flessibile 150cm.
Built-in shower set, including: built-in 2-handle hot/cold mixer with diverter SKYLINE, rectangular brass sliding rail, wall water connection, 30cm rectangular brass wall arm, 24x14cm rectangular brass shower head, 1-function rectangular brass hand shower, 150cm flexible hose.

CR FIN A FIN B

— CUCINA - KITCHEN —



SK617

Miscelatore monocomando per lavello, con bocca alta squadrata girevole.
Single-lever one-hole sink mixer, with high squared swivel spout.

CR FIN A FIN B



W7100

Monoforo lavello con bocca girevole e doppio comando.
Dual control one-hole sink mixer with swiveling spout.

CR FIN A FIN B

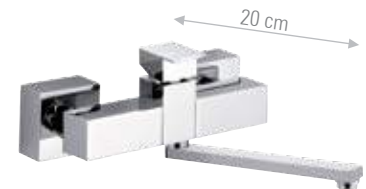

SK609

Miscelatore lavello a muro con canna girevole.
Wall mounted single lever sink mixer with movable spout.

CR FIN A FIN B



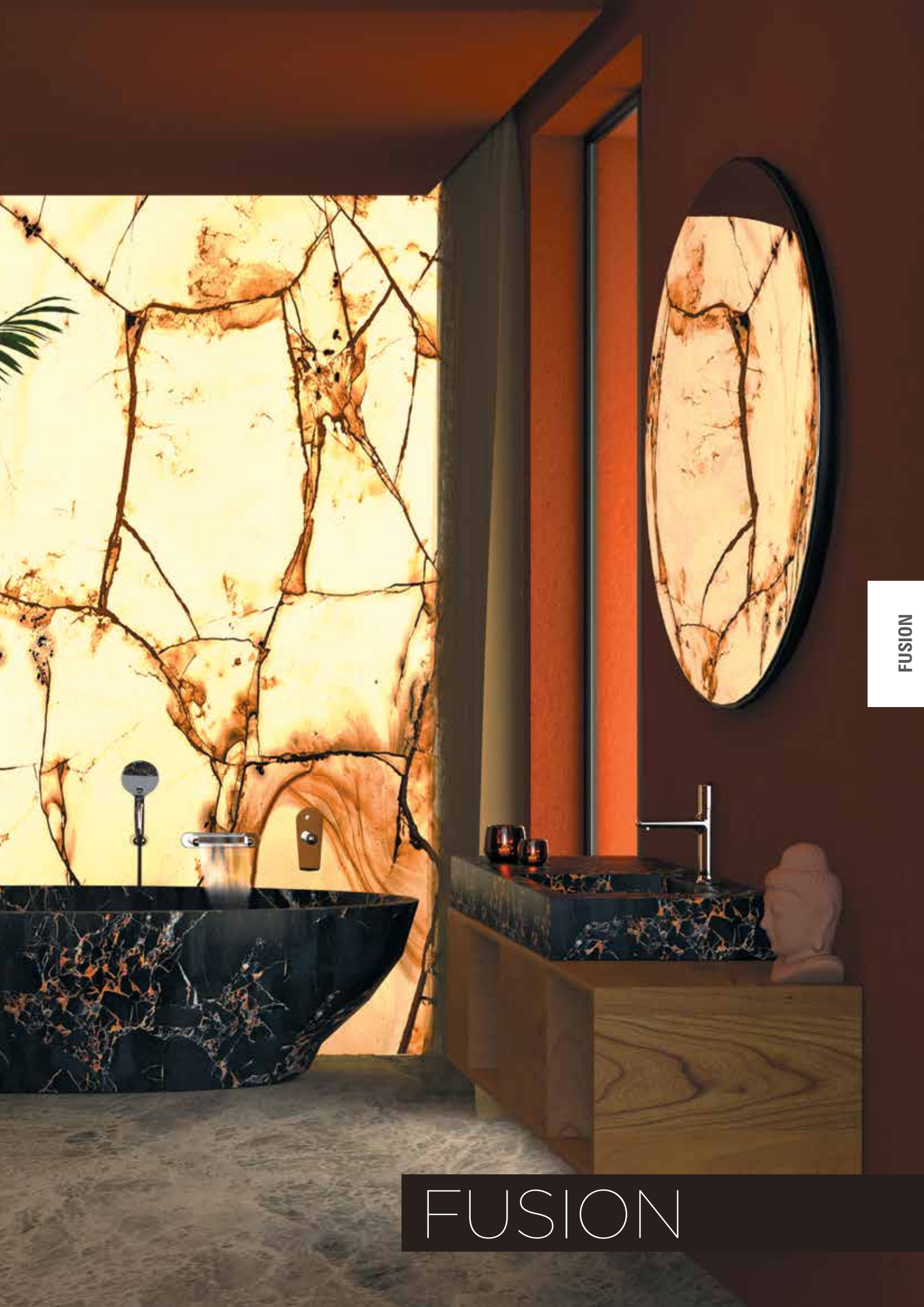

FUSION

FUSION



Le linee di FUSION appaiono come plasmate dagli elementi della natura e tutta la serie sprigiona sensazioni di armonia sia alla vista che al tatto. La basetta diventa parte stessa del corpo miscelatore creando una figura unica e scultorea. L'aeratore a scomparsa esalta la linea del prodotto donandogli ulteriore eleganza.

FUSION lines appear as shaped by the elements of nature and the whole series emanates feelings of harmony both to the eye and to the touch. The base becomes part of the mixer body creating an unique and sculptural shape. The hidden aerator enhances the product lines by giving it further elegance.

.....
CARATTERISTICHE TECNICHE:

La serie è dotata di cartuccia a dischi ceramici, Ø 35 mm, prodotta da S.T.S.R. – Studio Tecnico Sviluppo e Ricerche - www.stsr.it

.....
TECHNICAL FEATURES:

The series is equipped with ceramic cartridge, Ø 35 mm, produced by S.T.S.R. - Research Development Technical Office - www.stsr.it

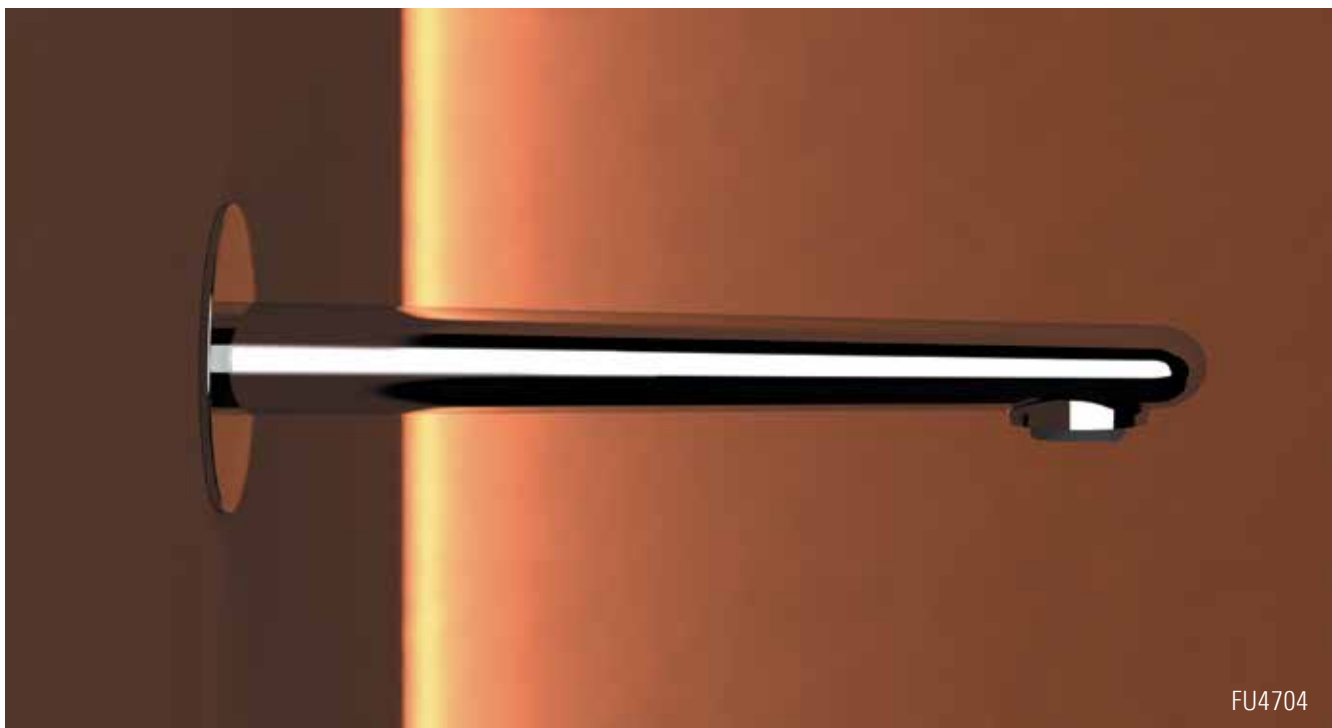

FU4704



FU606N



FU604

AMBITION

TRILOGY

TIARA

TOKYO

SKYLINE

FUSION

DIVA

SPEED

SWING

JAX



FU607D0LE15

D0LE15
NERO OPACO / ORO LUCIDO
MATT BLACK / SHINY GOLD

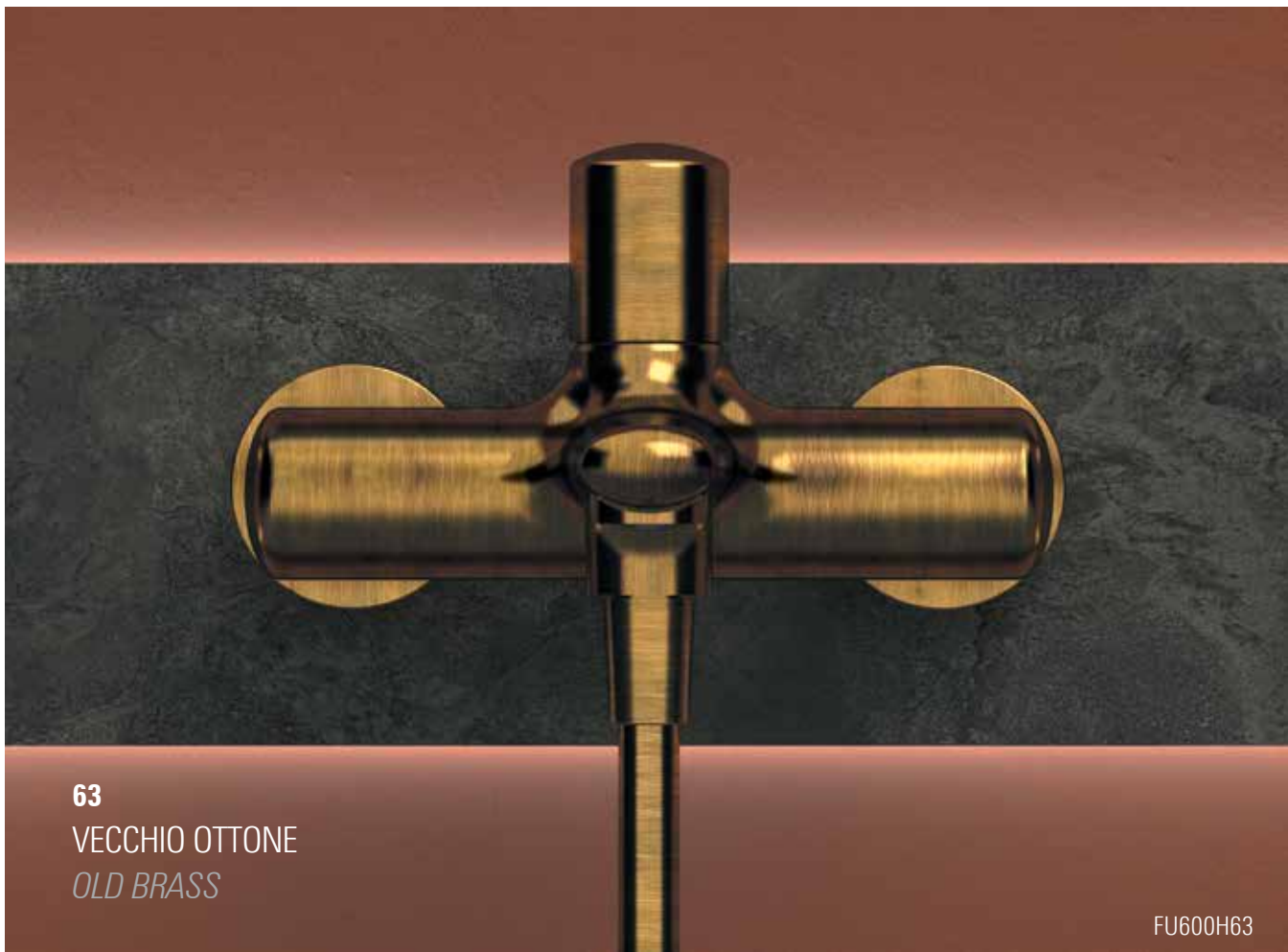

63
VECCHIO OTTONE
OLD BRASS

FU600H63

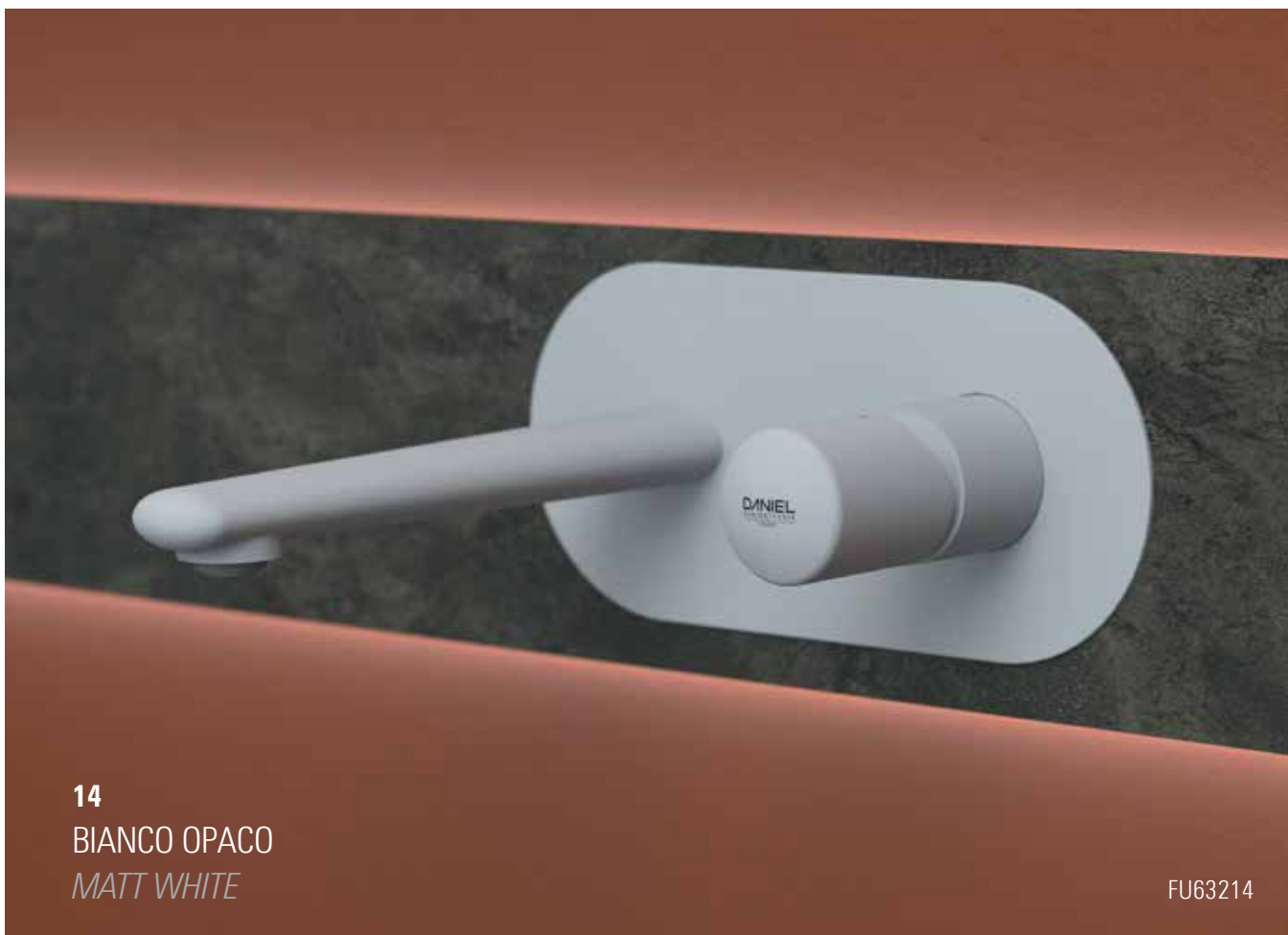

14
BIANCO OPACO
MATT WHITE

FU63214

AMBITION

TRILOGY

TIARA

TOKYO

SKYLINE

FUSION

DIVA

SPEED

SWING

JAX

LAVABI - WASHBASIN MIXERS



FU605

Monocomando lavabo, con scarico.
Single-lever basin mixer, with pop-up waste.

CR	FIN A
FIN B	BICOLOR



FU606N

Monocomando lavabo, senza scarico e senza foro sul corpo.
Single-lever basin mixer, without waste and without body hole.

CR	FIN A
FIN B	BICOLOR

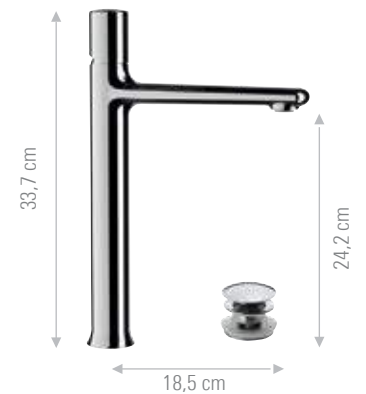

FU607

Monocomando lavabo alto, con scarico click-clack.
High single-lever basin mixer, with click-clack waste.

CR	FIN A
FIN B	BICOLOR

FU607B

Monocomando lavabo alto, senza scarico.
High single-lever basin mixer, without waste.

CR	FIN A
FIN B	BICOLOR



FU655

Miscelatore monocomando lavabo due fori.
Scarico non incluso.
Two-hole single-lever washbasin mixer. Waste not included.

CR	FIN A
FIN B	BICOLOR



FU655L

Miscelatore monocomando lavabo due fori, con bocca L. Scarico non incluso.
Two-hole single-lever washbasin mixer, with L spout. Waste not included.

CR	FIN A
FIN B	BICOLOR



FU4704

Bocca incasso.
Built-in spout.

CR	FIN A
FIN B	

LAVABO BOX INCASSO
BUILT-IN BOX WASHBASIN MIXER



FU632

Miscelatore monocomando a incasso per lavabo, con piastra orizzontale in ottone cromato.
Single-lever built-in basin mixer, with horizontal wall flange in chrome plated brass.

CR	FIN A
FIN B	BICOLOR

FU632KB

Miscelatore monocomando a incasso per lavabo, con piastra in ottone, bocca lunghezza 19 cm, da abbinare al box incasso.
Single-lever built-in basin mixer, with wall flange in brass, spout length 19 cm, to use with the built-in box.

CR	FIN A
FIN B	BICOLOR

DANBOX632

Box incasso per miscelatore monocomando a incasso per lavabo.
Built-in box for single-lever built-in basin mixer.

CR

BIDET



FU604

Monocomando bidet, con scarico.
Single-lever bidet mixer, with pop-up waste.

CR	FIN A
FIN B	BICOLOR



FU604BN

Miscelatore bidet, senza scarico e senza foro sul corpo.
Bidet mixer, without waste and without body hole.

CR	FIN A
FIN B	BICOLOR



FU6454DC

Miscelatore incasso per shut-off, con doccetta shut-off, supporto doccia e presa acqua.
Built-in shut-off mixer set, with shut-off, shower holder and water punch.

CR	FIN A
FIN B	BICOLOR



FU6424DC

Miscelatore incasso per shut-off con doccetta shut-off, supporto doccia e presa acqua.
Built-in shut-off mixer set, with handshower shut-off, shower holder and water punch.

CR	FIN A
FIN B	BICOLOR

MISCELATORI VASCA E DOCCIA - SHOWER AND BATH MIXERS



FU610

Miscelatore vasca esterno, con kit doccia e flessibile da 150 cm.

Exposed bath mixer, with shower kit and 150 cm flexible.

CR	FIN A
FIN B	BICOLOR



FU631A

Miscelatore doccia esterno, con kit doccia e flessibile da 150 cm.

Exposed shower mixer, with shower kit and 150 cm flexible.

CR	FIN A
FIN B	BICOLOR



FU600H

Miscelatore vasca esterno, senza kit doccia.

Exposed bath mixer, without shower kit.

CR	FIN A
FIN B	BICOLOR



FU631

Miscelatore doccia esterno, senza kit doccia.

Exposed shower mixer, without shower kit.

CR	FIN A
FIN B	BICOLOR

A388477



Saliscendi cromato con asta minimale ovale dritta, doccetta cromata a 4 funzioni, pulsante per cambio getti, anticalcare e flessibile conico in ottone cromato cm 150 Art. A505X150. Altezza: 65 cm.









C.p. sliding rail set with c.p. handshower 4 functions, with button to change the jets, anti-limestone and conical shower flexible in c.p. brass cm 150 Art. A505X150. Height: 65 cm.

CR



DOCCETTA IN FINITURA
FINISH HAND SHOWER

Il modello della doccetta inclusa nel kit può variare in base alla finitura scelta.
The model of the hand shower included in the kit may vary according to the chosen finish.

CR	FIN A						FIN B				
											
CR	15	14	NP	63	OIL	64	DO	DP	FZ	CF	RP
Doccetta abs, 4 funzioni. <i>ABS hand shower, 4-function.</i>	Doccetta minimale in ottone, 1 funzione. <i>Minimal brass hand shower, 1-function.</i>										

□ □ □ 2 VIE - 2-WAY □ □ □



FU700D2Q

Set miscelatore a incasso a 2 vie per vasca/doccia su piastra unica rettangolare, include miscelatore monocomando, deviatore a 2 uscite, bocca a muro. Da completare con una seconda uscita acqua.
2-way built-in mixer set for bathtub / shower on single rectangular plate, including single-lever mixer, 2-way diverter, wall spout. To be completed with a second water outlet.

CR FIN A FIN B



FU700D2P

Set miscelatore a incasso a 2 vie per vasca/doccia su 3 piastre tonde separate (piastre separate e incasso unico), include: miscelatore monocomando, deviatore a 2 uscite, bocca a muro. Da completare con una seconda uscita.
2-way built-in mixer set for bathtub / shower on 3 separate round plates (separate plates, one single built-in part), including: single-lever mixer, 2-way diverter, wall spout. To be completed with a second water outlet.

CR FIN A FIN B



FU710D2Q

Set a incasso a 2 vie per vasca, include: miscelatore monocomando, deviatore a 2 uscite e bocca a muro su piastra unica rettangolare; set doccia su piastra quadrata con presa acqua, supporto integrato, doccetta in ottone e flessibile 150cm.
2-way built-in set for bathtub, including: single-lever mixer, 2-way diverter and wall spout on a single rectangular plate; shower set on square plate with water connection, holder, brass handshower and 150cm flexible hose.

CR FIN A FIN B



FU710D2P

Set a incasso a 2 vie per vasca su piastre tonde separate (3 piastre separate e incasso unico), include: miscelatore monocomando con deviatore a 2 uscite, bocca a muro; set doccia su piastra tonda con presa acqua, supporto, doccetta e flessibile 150cm.
2-way built-in set for bathtub on separate round plates (3 separate plates, one single built-in part), including: single-lever mixer, 2-way diverter, wall spout; Shower set on round plate with water connection, holder, hand shower and 150cm flexible hose.

CR FIN A FIN B

□ □ □ 3 VIE - 3-WAY □ □ □



FU700D3Q

Set miscelatore a incasso a 3 vie per vasca/doccia su piastra unica rettangolare, include miscelatore monocomando, deviatore a 3 uscite, bocca a muro. Da completare con una seconda e una terza uscita acqua.
3-way built-in mixer set for bathtub/shower on single rectangular plate, including single-lever mixer, 3-way diverter, wall spout. To be completed with second and third water outlets.

CR FIN A FIN B



FU700D3P

Set miscelatore a incasso a 3 vie per vasca/doccia su 3 piastre tonde separate (piastre separate e parte a incasso unica), composto da: miscelatore monocomando con deviatore a 3 uscite, bocca a muro. Da completare con una seconda e una terza uscita acqua.
3-way built-in mixer set for bathtub/shower on 3 separate round plates (separate plates, one single built-in part), including: single-lever mixer with 3-way diverter, wall spout. To be completed with second and third water outlets.

CR FIN A FIN B

INCASSI DOCCIA - BUILT-IN MIXERS

□ □ □ 1 VIA - 1-WAY □ □ □



FU602

Miscelatore incasso per doccia (articolo COMPLETO).
Built-in shower mixer (COMPLETE item).

CR	FIN A
FIN B	BICOLOR

IN602C35

SOLO parti a incasso
Built-in parts ONLY.

CR	FIN A	FIN B
----	-------	-------

FU602EKIT

SOLO parti esterne.
Exposed parts ONLY.

CR	FIN A	FIN B
----	-------	-------



FU612

Miscelatore incasso con deviatore per vasca/doccia (articolo COMPLETO).
Built-in bath/shower mixer with diverter (COMPLETE item).

CR	FIN A
FIN B	BICOLOR

IN612C35

SOLO parti a incasso
Built-in parts ONLY.

CR	FIN A	FIN B
----	-------	-------

FU612EKIT

SOLO parti esterne.
Exposed parts ONLY.

CR	FIN A	FIN B
----	-------	-------



FU612D2

Miscelatore incasso con deviatore a 2 vie per vasca/doccia su piastra lusso ultrapiatta (articolo COMPLETO).
Built-in bath/shower mixer with 2-way diverter on luxury ultraslim plate (COMPLETE item).

CR	FIN A
FIN B	BICOLOR



FU712D2Q

Set miscelatore a incasso a 2 vie per doccia su piastra unica rettangolare, include presa acqua con supporto, doccetta e flessibile 150 cm. Da completare con una 2° uscita.
2-way built-in shower mixer set on a single rectangular plate, including water connection with shower holder, hand shower and 150cm hose. To be completed with a 2nd water outlet.

CR	FIN A
FIN B	BICOLOR



FU712D2P

Set miscelatore a incasso a 2 vie per doccia su 3 piastre tonde separate (parte a incasso unica), include: miscelatore e deviatore a 2 uscite, presa acqua con supporto, doccetta in ottone e flessibile 150 cm. Da completare con una 2° uscita.
2-way built-in shower mixer set on 3 separate round plates (single built-in part), including: mixer and 2-way diverter, water connection with holder, brass hand shower and 150cm flexible hose. To be completed with a 2nd water outlet.

CR	FIN A
FIN B	BICOLOR

□ □ □ 3 VIE - 3-WAY □ □ □



FU612D3

Miscelatore incasso con deviatore a 3 vie per vasca/doccia , 1 entrata e 3 uscite (articolo COMPLETO).

Built-in bath/shower mixer with 3-way diverter, 1 inlet and 3 outlets (COMPLETE item).

CR	FIN A
FIN B	BICOLOR



FU712D3Q

Set miscelatore a incasso a 3 vie per doccia su piastra unica rettangolare, include: miscelatore, deviatore a 3 uscite, presa acqua con supporto, doccetta in ottone e flessibile 150 cm.

Da completare con una seconda e una terza uscita acqua. Da completare con una 2° ed una 3° uscita.

3-way built-in shower mixer set on a single rectangular plate, including: single-lever mixer, 3-way diverter, water connection with shower holder, brass hand shower and 150cm flexible hose. To be completed with a 2nd and 3rd water outlet.

CR	FIN A
FIN B	BICOLOR



FU712D3P

Set miscelatore a incasso a 3 vie per doccia su 3 piastre tonde separate (parte a incasso unica), include: miscelatore e deviatore a 3 uscite, presa acqua con supporto, doccetta in ottone e flessibile 150cm. Da completare con una 2° ed una 3° uscita.

3-way built-in shower mixer set on 3 separate round plates (single built-in part), including: mixer and 3-way diverter, water connection with holder, brass hand-shower and 150cm flexible hose. To be completed with a 2nd and 3rd water outlet.

CR	FIN A
FIN B	BICOLOR

□ □ □ 4/5 VIE - 4/5-WAY □ □ □



FU612D4

Miscelatore incasso con deviatore a 4 vie per vasca/doccia , 1 entrata e 4 uscite (articolo COMPLETO).

Built-in bath/shower mixer with 4-way diverter, 1 inlet and 4 outlets (COMPLETE item).

CR	FIN A
FIN B	BICOLOR



FU612D5

Miscelatore incasso con deviatore a 5 vie per vasca/doccia , 1 entrata e 5 uscite (articolo COMPLETO).

Built-in bath/shower mixer with 5-way diverter, 1 inlet and 5 outlets (COMPLETE item).

CR	FIN A
FIN B	BICOLOR

COLONNE DOCCIA - SHOWER COLUMNS



FU636DAAD20

Set colonna vasca/doccia a 3 vie, composto da: miscelatore esterno vasca/doccia per colonna con deviatore FUSION, colonna telescopica ad altezza regolabile, soffione 20x20 cm in abs con angoli arrotondati, doccetta in ABS a 4 funzioni con pulsante per il cambio dell'intensità, flessibile 150cm. *3-way bath/shower column set, including: exposed bath/shower mixer for column with diverter FUSION, height-adjustable telescopic column, 20x20 cm c.p. abs shower head with rounded corners, 4-function abs hand shower with button for switching jet modes, 150cm flexible hose.*

CR



FU636DA3MP7820

Con soffione da Ø 20 cm. *With head shower Ø 20 cm.*

CR 15

FU636DA3MP7825

Con soffione da Ø 25 cm. *With head shower Ø 25 cm.*

CR 15

FU636DA3MP7830

Con soffione da Ø 30 cm. *With head shower Ø 30 cm.*

CR 15



FU636AAD20

Set colonna vasca/doccia a 3 vie, composto da: miscelatore esterno vasca/doccia per colonna con deviatore FUSION, colonna telescopica ad altezza regolabile, soffione 20x20 cm in abs con angoli arrotondati, doccetta in ABS a 4 funzioni con pulsante per il cambio dell'intensità, flessibile 150cm. *3-way bath/shower column set, including: exposed bath/shower mixer for column with diverter FUSION, height-adjustable telescopic column, 20x20 cm c.p. abs shower head with rounded corners, 4-function abs hand shower with button for switching jet modes, 150cm flexible hose.*

CR

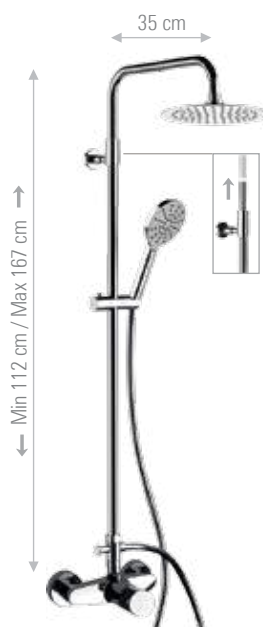

FU636A3MP7820

Con soffione da Ø 20 cm. *With head shower Ø 20 cm.*

CR 15

FU636A3MP7825

Con soffione da Ø 25 cm. *With head shower Ø 25 cm.*

CR 15

FU636A3MP7830

Con soffione da Ø 30 cm. *With head shower Ø 30 cm.*

CR 15



FU614Z

Set doccia a incasso, composto da: miscelatore a incasso con deviatore FUSION, asta saliscendi, attacco presa acqua a muro, braccio a muro in ottone 30cm, soffione in abs con angoli arrotondati, doccetta in ABS a 4 funzioni con pulsante per il cambio dell'intensità, flessibile 150cm.
Built-in shower set, including: built-in mixer with diverter FUSION, brass sliding rail, wall water connection, 30cm brass wall arm, c.p. abs shower head with rounded corners, 4-function abs hand shower with button for switching jet modes, 150cm flexible hose.

— CR —



FU615Z

Set doccia a incasso, composto da: miscelatore a incasso con deviatore FUSION, attacco presa acqua a muro con supporto per doccetta, braccio a muro in ottone 30cm, soffione in abs con angoli arrotondati, doccetta in ABS a 4 funzioni con pulsante per il cambio dell'intensità, flessibile 150cm.
Built-in shower set, including: built-in mixer with diverter FUSION, wall water connection with hand shower holder, 30cm brass wall arm, c.p. abs shower head with rounded corners, 4-function abs hand shower with button for switching jet modes, 150cm flexible hose.

— CR —



CR

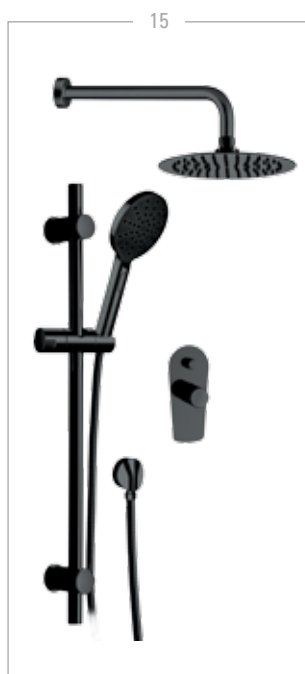

15

Set doccia a incasso, composto da: miscelatore a incasso con deviatore FUSION, asta saliscendi in ottone, attacco presa acqua a muro, braccio a muro in ottone 30cm, soffione ultra piatto in acciaio INOX lucidato a specchio, doccetta in abs a 3 funzioni, flessibile 150cm.
Built-in shower set, including: built-in mixer with diverter FUSION, brass sliding rail, wall water connection, 30cm brass wall arm, ultra-flat Ø20cm shower head in mirror-polished stainless steel, 3-function abs hand shower, 150cm flexible hose.

FU614ZL3MP7820

Con soffione da Ø20 cm.
With head shower Ø20 cm.

— CR — — 15 —

FU614ZL3MP7825

Con soffione da Ø25 cm.
With head shower Ø25 cm.

— CR — — 15 —

FU614ZL3MP7830

Con soffione da Ø30 cm.
With head shower Ø30 cm.

— CR — — 15 —



Set doccia a incasso, composto da: miscelatore a incasso con deviatore FUSION, attacco presa acqua a muro con supporto per doccetta, braccio a muro in ottone 30cm, soffione ultra piatto in acciaio INOX lucidato a specchio, doccetta in ABS a 4 funzioni con pulsante per il cambio dell'intensità, flessibile 150cm.

Built-in shower set, including: built-in mixer with diverter FUSION, wall water connection with hand shower holder, 30cm brass wall arm, ultra-flat shower head in mirror-polished stainless steel, 4-function abs hand shower with button for switching jet modes, 150cm flexible hose.

FU615ZL3MP7820

Con soffione da Ø20 cm.
With head shower Ø20 cm.

CR	15
----	----

FU615ZL3MP7825

Con soffione da Ø25 cm.
With head shower Ø25 cm.

CR	15
----	----

FU615ZL3MP7830

Con soffione da Ø30 cm.
With head shower Ø30 cm.

CR	15
----	----



Set doccia a incasso, composto da: miscelatore a incasso con deviatore FUSION, asta saliscendi in ottone, attacco presa acqua a muro, braccio a muro in ottone 30cm, soffione Ø 20 cm in ottone, doccetta in ottone a 1 funzione, flessibile 150cm.

Built-in shower set, including: built-in mixer with diverter FUSION, brass sliding rail, wall water connection, 30cm brass wall arm, Ø 20cm brass shower head, 1-function brass hand shower, 150cm flexible hose.

FU614ZOL

Con soffione da Ø20 cm.
With head shower Ø20 cm.

CR	FIN A	FIN B
----	-------	-------

FU614ZOL9430

Con soffione da Ø25 cm.
With head shower Ø25 cm.

CR	FIN A	FIN B
----	-------	-------



Set doccia a incasso, composto da: miscelatore a incasso con deviatore FUSION, attacco presa acqua a muro con supporto per doccetta, braccio a muro in ottone 30cm, soffione Ø 20 cm in ottone, doccetta in ottone a 1 funzione, flessibile 150cm.

Built-in shower set, including: built-in mixer with diverter FUSION, wall water connection with hand shower holder, 30cm brass wall arm, brass shower head, 1-function brass hand shower, 150cm flexible hose.

FU615ZOL

Con soffione da Ø20 cm.
With head shower Ø20 cm.

CR	FIN A	FIN B
----	-------	-------

FU615ZOL9430

Con soffione da Ø25 cm.
With head shower Ø25 cm.

CR	FIN A	FIN B
----	-------	-------

CUCINA - KITCHEN



FU618

Miscelatore monocomando monoforo 90°, con canna alta a "U".

Single-lever sink mixer 90°, high "U" spout.

CR	FIN A
FIN B	BICOLOR



FU614B

Miscelatore monocomando per lavello, con bocca alta girevole.

Single-lever one-hole sink mixer, with high movable spout.

CR	FIN A
FIN B	BICOLOR



FU614BC

Miscelatore monocomando per lavello, con bocca alta girevole, modello corto.

Single-lever one-hole sink mixer, with high movable spout, short model.

CR	FIN A
FIN B	BICOLOR

ACQUA DEPURATA
PURIFIED WATER



FU679DW

Miscelatore lavello a 3 vie di ingresso con bocca girevole e due vie d'uscita completamente indipendenti per acqua depurata e acqua corrente. Selezione dell'acqua depurata tramite deviatore laterale.

3-ways sink mixer with swivel spout and two completely independent outlets for purified water and running water. Selection of purified water from side diverter.

CR	FIN A
FIN B	BICOLOR

GOURMET

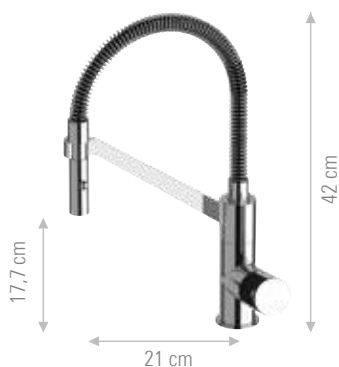

FU233

Miscelatore lavello monocomando con flessibile nero rivestito con molla "fine design" girevole 360°, con doccetta estraibile dal supporto ed orientabile a due funzioni e cartuccia Ø 35.

Single-lever mixer with black flexible hose coated with "fine design" spring, 360° movable, with detachable and adjustable 2-functions hand shower and Ø 35 mm cartridge.

CR

TOUCH-ME



FUT618

Miscelatore monocomando lavello, monoforo 90° con canna alta ad "U" dotata di tecnologia Touch-Me con leva laterale e bocca girevole. Dotato di cartuccia Ø35.

Single-lever sink mixer 90°, high "U" spout equipped with Touch-Me system with side lever and movable spout. Equipped with Ø35 cartridge.

CR	FIN A
FIN B	BICOLOR





DIVA

DIVA



DV691

DIVA è una collezione leggera e delicata, specchio di una raffinata cultura dell'abitare. Nata dal desiderio di massima proporzione, si fa portavoce di un'elegante modernità.

Diva is a light and delicate collection, mirror of a refined living culture. Born from the desire of highest proportion, it echoes of an elegant modernity.

CARATTERISTICHE TECNICHE:

La serie è dotata di cartuccia a dischi ceramici Ø 25 mm, tranne gli incassi che utilizzano la cartuccia a dischi ceramici Ø 35 mm. Cartucce prodotte da S.T.S.R. – Studio Tecnico Sviluppo e Ricerche, www.stsr.it

TECHNICAL FEATURES:

The series is equipped with ceramic cartridge Ø25 mm, except built-in items that use ceramic cartridge Ø35 mm., Cartridges are produced by S.T.S.R. - Research Development Technical Office, www.stsr.it



DV5022

AMBITION

TRILOGY

TIARA

TOKYO

SKYLINE

FUSION

DIVA

SPEED

SWING

JAX



DV607DP

DP
ORO SPAZZOLATO
BRUSHED GOLD



DO
ORO LUCIDO
SHINY GOLD

DV606DO



OIL
OIL BRONZE
OIL BRONZE

DV606OIL

AMBITION

TRILOGY

TIARA

TOKYO

SKYLINE

FUSION

DIVA

SPEED

SWING

JAX

LAVABI - WASHBASIN MIXERS



DV605

Monocomando lavabo, con scarico
Single-lever basin mixer, with pop-up waste.

CR FIN A FIN B



DV607

Monocomando lavabo alto, con scarico click-clack.
High basin mixer, with click-clack waste.

CR FIN A FIN B

DV606

Monocomando lavabo, senza scarico e senza foro nel corpo.
Single-lever basin mixer, without waste and without body hole.

CR FIN A FIN B

DV607B

Monocomando lavabo alto, senza scarico.
High basin mixer, without click-clack waste.

CR FIN A FIN B

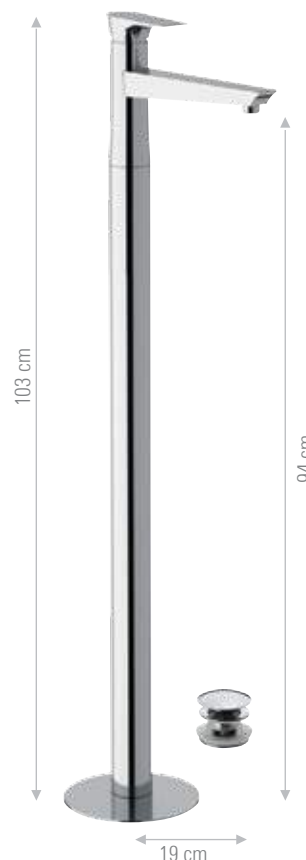

DV688

Miscelatore monocomando lavabo da pavimento con scarico click-clack con troppo pieno.
Single-lever mixer floor mounting with click clack with overflow waste.

CR FIN A FIN B

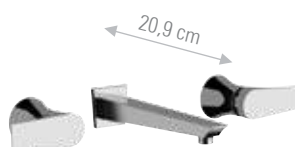

DV5022

Batteria lavabo da incasso.
Concealed basin mixer.

CR FIN A FIN B



DV632

Miscelatore monocomando a incasso per lavabo.
Single-lever built-in basin mixer.

CR FIN A FIN B

LAVABO BOX INCASSO - BUILT-IN BOX WASHBASIN MIXER



DV632KB

Miscelatore monocomando a incasso per lavabo, con piastra in ottone, bocca lunghezza 20,5 cm, da abbinare al box incasso.
Single-lever built-in basin mixer, with wall flange in brass, spout lenght 20,5 cm, to use with the built-in box.

CR FIN A FIN B

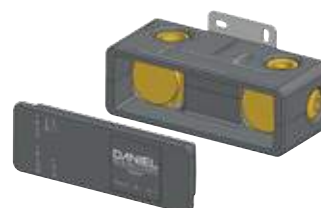

DANBOX632

Box incasso per miscelatore monocomando a incasso per lavabo.
Built-in box for single-lever built-in basin mixer.

CR

— BIDET —



DV604

Monocomando bidet, con scarico.
Single-lever bidet mixer, with pop-up waste.

CR FIN A FIN B



DV642

Miscelatore incasso per shut-off con doccetta shut-off, supporto doccia, presa acqua.
Built-in shut-off mixer set shut-off, shower holder, water punch.

CR FIN A FIN B



DV604B

Monocomando bidet, senza scarico e senza foro nel corpo.
Single-lever bidet mixer, without waste and without body hole.

CR FIN A FIN B



DV646

Miscelatore incasso per shut-off.
Built-in shut-off mixer.

CR FIN A FIN B

— MISCELATORI VASCA E DOCCIA - SHOWER AND BATH MIXERS —



DV610

Miscelatore vasca esterno, con kit doccia, flessibile 150 cm.
Exposed bath mixer, with shower kit, flexible 150 cm.

CR FIN A FIN B



DV600

Miscelatore vasca esterno, con kit doccia, flessibile 120 cm.
Exposed bath mixer, with shower kit, flexible 120 cm.

CR FIN A FIN B



DV600H

Miscelatore vasca esterno, senza kit doccia.
Exposed bath mixer, without shower kit.

CR FIN A FIN B



DV699

Miscelatore monocomando bordo vasca con bocca multigetto.
Single lever deck bath/shower mixer with multijet spout.

CR FIN A FIN B



DV691

Miscelatore monocomando bordo vasca.
Single lever deck bath/shower mixer.

CR FIN A FIN B

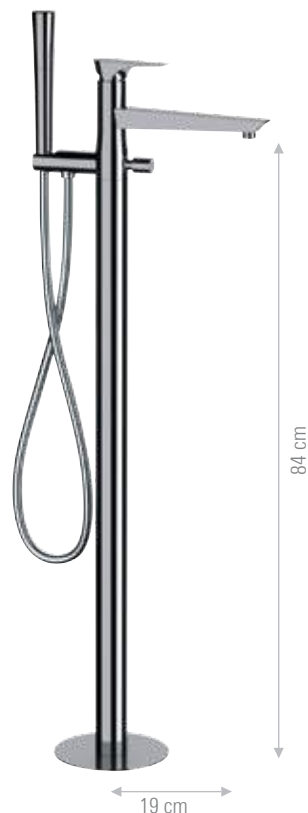

DV678

Miscelatore vasca da pavimento con deviatore e kit doccia.
Free standing bath mixer floor mounting with diverter and shower kit.

CR FIN A FIN B



DV652

Miscelatore monocomando per vasca da incasso, su piastra in ottone cromato.
Single-lever bath mixer, with wall flange in chrome plated.

CR FIN A FIN B



DV4491

Batteria bordo vasca con doccetta estraibile.
Bathtub set with pull-out handshower.

CR FIN A FIN B



DV4192

Miscelatore bordo vasca quattro fori con canna con deviatore e doccetta estraibile.
Deck bath set with diverter, casted spout and pull-out handshower.

CR FIN A FIN B



DV611A

Miscelatore doccia esterno con kit doccia.
Exposed shower mixer with shower kit.

CR FIN A FIN B



DV611

Miscelatore doccia esterno senza kit doccia.
Exposed shower mixer without shower kit.

CR FIN A FIN B



DV611Z

Monocomando doccia esterno con attacco 3/4 M per colonna.
Exposed shower mixer with connection 3/4 M for columns.

CR FIN A FIN B



DV4454

Rubinetto arresto incasso 1/2".
Built-in stop valve 1/2".

CR FIN A FIN B

CUCINA - KITCHEN



DV608

Monocomando lavello girevole.
Swivelling single-lever Sink mixer.



CR FIN A FIN B

COLONNE DOCCIA - SHOWER COLUMNS

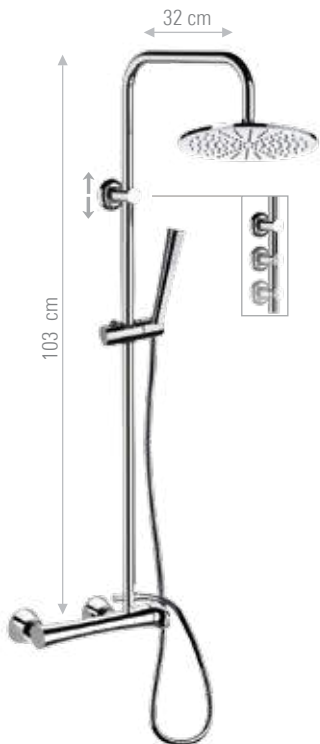

DV636XCR

Set colonna doccia, composto da: miscelatore esterno per colonna DIVA, colonna con fissaggio superiore regolabile e deviatore, flessibile 150cm, soffione Ø 20 cm in ottone, doccetta Diva in ottone a 1 funzione.
Shower column set, including: exposed mixer for column DIVA, column with adjustable upper fixing and diverter, 150cm flexible hose, Ø 20cm brass shower head, 1-function DIVA brass hand shower.

CR FIN A FIN B



DV636ACR

Set colonna doccia, composto da: miscelatore esterno per colonna DIVA, colonna telescopica ad altezza regolabile con deviatore, flessibile doccia 150cm, soffione Ø 20 cm in ottone, doccetta Diva in ottone a 1 funzione.
Shower column set, including: exposed mixer for column DIVA, height-adjustable telescopic column with diverter, 150cm flexible hose, Ø 20cm brass shower head, 1-function DIVA brass hand shower.

CR FIN A FIN B

INCASSI DOCCIA - BUILT-IN MIXERS

□ □ □ 1 VIA - 1-WAY □ □ □



DV602

Miscelatore incasso per doccia (articolo COMPLETO).
Built-in shower mixer (COMPLETE item).

CR	FIN A	FIN B
----	-------	-------

IN602C35

SOLO parti a incasso
Built-in parts ONLY.

CR	FIN A	FIN B
----	-------	-------

DV602EKIT

SOLO parti esterne.
Exposed parts ONLY.

CR	FIN A	FIN B
----	-------	-------



DV602B

Miscelatore incasso per doccia con piastra Diva Dance On (articolo COMPLETO).
Built-in shower mixer with Diva Dance On Plate (COMPLETE item).

CR	FIN A	FIN B
----	-------	-------

IN602C35

SOLO parti a incasso
Built-in parts ONLY.

CR	FIN A	FIN B
----	-------	-------

DV602BEKIT

SOLO parti esterne.
Exposed parts ONLY.

CR	FIN A	FIN B
----	-------	-------

□ □ □ 2 VIE - 2-WAY □ □ □



DV612

Miscelatore incasso con deviatore per vasca/doccia (articolo COMPLETO).
Built-in bath/shower mixer with diverter (COMPLETE item).

CR	FIN A	FIN B
----	-------	-------

IN612C35

SOLO parti a incasso
Built-in parts ONLY.

CR	FIN A	FIN B
----	-------	-------

DV612EKIT

SOLO parti esterne.
Exposed parts ONLY.

CR	FIN A	FIN B
----	-------	-------



DV612B

Miscelatore incasso con deviatore per vasca/
doccia con piastra Diva Dance On
(articolo COMPLETO).

*Built-in bath/shower mixer with diverter on Diva
Dance On Plate (COMPLETE item).*

CR	FIN A	FIN B
----	-------	-------

IN612C35

SOLO parti a incasso
Built-in parts ONLY.

CR	FIN A	FIN B
----	-------	-------

DV612BEKIT

SOLO parti esterne.
Exposed parts ONLY.

CR	FIN A	FIN B
----	-------	-------

□ □ □ 3 VIE - 3-WAY □ □ □



DV612D2

Miscelatore incasso con deviatore a 2 vie per vasca/doccia su piastra
lusso ultrapiatta (articolo COMPLETO).

*Built-in bath/shower mixer with 2-way diverter on luxury ultraslim plate
(COMPLETE item).*

CR	FIN A	FIN B
----	-------	-------



DV612D3

Miscelatore incasso con deviatore a 3 vie per vasca/doccia , 1 entrata e
3 uscite (articolo COMPLETO).

*Built-in bath/shower mixer with 3-way diverter, 1 inlet and 3 outlets
(COMPLETE item).*

CR	FIN A	FIN B
----	-------	-------

□ □ □ 4/5 VIE - 4/5-WAY □ □ □



DV612D4

Miscelatore incasso con deviatore a 4 vie per vasca/doccia , 1 entrata e 4
uscite (articolo COMPLETO).

*Built-in bath/shower mixer with 4-way diverter, 1 inlet and 4 outlets
(COMPLETE item).*

CR	FIN A	FIN B
----	-------	-------



DV612D5

Miscelatore incasso con deviatore a 5 vie per vasca/doccia , 1 entrata e 5
uscite (articolo COMPLETO).

*Built-in bath/shower mixer with 5-way diverter, 1 inlet and 5 outlets
(COMPLETE item).*

CR	FIN A	FIN B
----	-------	-------

BOCCHIE - SPOUTS



DC4704

Bocca incasso a cascata.
Built-in spout with waterfall.

CR FIN A FIN B

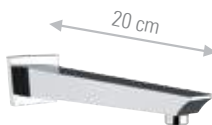

DV4704

Bocca incasso 20 cm.
Built-in spout 20 cm.

CR FIN A FIN B



F4705

Bocca bordo vasca con effetto multigetto.
Spout with multijet effect for deck bath/shower mixer.

CR FIN A FIN B

KIT WELLNESS - WELLNESS KIT



Set doccia a incasso, composto da: miscelatore a incasso con deviatore DIVA, asta saliscendi in ottone, attacco presa acqua a muro, braccio a muro in ottone 30cm, soffione ultra piatto in acciaio INOX lucidato a specchio, doccetta Diva in ottone a 1 funzione, flessibile 150cm.
Built-in shower set, including: built-in mixer with diverter DIVA, brass sliding rail, wall water connection, 30cm brass wall arm, ultra-flat Ø20cm shower head in mirror-polished stainless steel, 1-function DIVA brass hand shower, 150cm flexible hose.

DV614ZL7820

Con soffione da Ø20 cm.
With head shower Ø20 cm.

CR 15

DV614ZL7825

Con soffione da Ø25 cm.
With head shower Ø25 cm.

CR 15

DV614ZL7830

Con soffione da Ø30 cm.
With head shower Ø30 cm.

CR 15



Set doccia a incasso, composto da: miscelatore a incasso con deviatore DIVA, attacco presa acqua a muro con supporto per doccetta, braccio a muro in ottone 30cm, soffione ultra piatto in acciaio INOX lucidato a specchio, doccetta Diva in ottone a 1 funzione, flessibile 150cm.
Built-in shower set, including: built-in mixer with diverter DIVA, wall water connection with hand shower holder, 30cm brass wall arm, ultra-flat shower head in mirror-polished stainless steel, 1-function DIVA brass hand shower, 150cm flexible hose.

DV615ZL7820

Con soffione da Ø20 cm.
With head shower Ø20 cm.

CR 15

DV615ZL7825

Con soffione da Ø25 cm.
With head shower Ø25 cm.

CR 15

DV615ZL7830

Con soffione da Ø30 cm.
With head shower Ø30 cm.

CR 15



DV614ZOL

Set doccia a incasso, composto da: miscelatore a incasso con deviatore DIVA, asta saliscendi in ottone, attacco presa acqua a muro, braccio a muro in ottone 30cm, soffione Ø 20 cm in ottone, doccetta Diva in ottone a 1 funzione, flessibile 150cm. *Built-in shower set, including: built-in mixer with diverter DIVA, brass sliding rail, wall water connection, 30cm brass wall arm, Ø 20cm brass shower head, 1-function DIVA brass hand shower, 150cm flexible hose.*

CR _____ FIN A _____ FIN B _____



DV615ZOL

Set doccia a incasso, composto da: miscelatore a incasso con deviatore DIVA, attacco presa acqua a muro con supporto per doccetta, braccio a muro in ottone 30cm, soffione Ø 20 cm in ottone, doccetta Diva in ottone a 1 funzione, flessibile 150cm. *Built-in shower set, including: built-in mixer with diverter DIVA, wall water connection with hand shower holder, 30cm brass wall arm, Ø 20cm brass shower head, 1-function DIVA brass hand shower, 150cm flexible hose.*

CR _____ FIN A _____ FIN B _____



DV4442CA

Set doccia a incasso, composto da: batteria a incasso con doppio comando caldo e freddo e deviatore DIVA, asta saliscendi in ottone, attacco presa acqua a muro, soffione a parete con getto a cascata, doccetta Diva in ottone a 1 funzione, flessibile 150cm. *Built-in shower set, including: built-in 2-handle hot/cold mixer with diverter DIVA, brass sliding rail, wall water connection, wall mounted waterfall jet, 1-function DIVA brass hand shower, 150cm flexible hose.*

CR _____ FIN A _____ FIN B _____



DV4441

Set doccia a incasso, composto da: batteria a incasso con doppio comando caldo e freddo e deviatore DIVA, attacco presa acqua a muro con supporto per doccetta, braccio a muro in ottone 30cm, soffione Ø 35 cm in ottone, doccetta Diva in ottone a 1 funzione, flessibile 150cm. *Built-in shower set, including: built-in 2-handle hot/cold mixer with diverter DIVA, wall water connection with hand shower holder, 30cm brass wall arm, Ø 35cm brass shower head, 1-function DIVA brass hand shower, 150cm flexible hose.*

CR _____ FIN A _____ FIN B _____



DV614ZC

Set doccia a incasso, composto da: miscelatore a incasso con deviatore su piastra DIVA Dance-On, asta saliscendi in ottone, attacco presa acqua a muro, soffione a parete con getto a cascata, doccetta Diva in ottone a 1 funzione, flessibile 150cm. *Built-in shower set, including: built-in shower mixer with diverter on DIVA Dance-On plate, brass sliding rail, wall water connection, wall mounted waterfall jet, 1-function DIVA brass hand shower, 150cm flexible hose.*

CR _____ FIN A _____ FIN B _____



DV4441CA

Set doccia a incasso, composto da: batteria a incasso con doppio comando caldo e freddo e deviatore DIVA, attacco presa acqua a muro con supporto per doccetta, soffione a parete con getto a cascata, doccetta Diva in ottone a 1 funzione, flessibile 150cm. *Built-in shower set, including: built-in 2-handle hot/cold mixer with diverter DIVA, wall water connection with hand shower holder, wall mounted waterfall jet, 1-function DIVA brass hand shower, 150cm flexible hose.*

CR _____ FIN A _____ FIN B _____





SPEED

SPEED



Il design moderno della collezione SPEED è ispirato alle forme del mondo dell'aeronautica. Aerodinamicità e leggerezza sono le caratteristiche dominanti in tutta la collezione.

I miscelatori monocomando SPEED sono un prodotto tecnicamente avanzato grazie all'utilizzo della cartuccia diametro 25, agli aeratori a scomparsa, al tettuccio proteggi snodo del bidet di nostro brevetto ed al particolare deviatore utilizzato sul gruppo vasca che aziona la deviazione dell'acqua semplicemente tirando il flessibile. Queste caratteristiche rendono SPEED un gioiello unico ed inconfondibile nel panorama della rubinetteria.

.....

CARATTERISTICHE TECNICHE:

La serie è dotata di cartuccia a dischi ceramici Ø 25 mm, tranne gli incassi che utilizzano la cartuccia a dischi ceramici Ø 35 mm. Cartucce prodotte da S.T.S.R. – Studio Tecnico Sviluppo e Ricerche, www.stsr.it

The modern design of the SPEED collection is inspired by the shapes of the aeronautical world. Aerodynamics and lightness are the dominant features throughout the collection.

The single-lever mixers of the SPEED are a technically advanced products thanks to the use of the 25 diameter cartridge, the retractable aerators, the patented protection cover of the bidet joint and the particular diverter used on the bath mixer which activates the water deviation simply by pulling the hose. All these features make SPEED is a unique and unmistakable jewel in faucets scene.

.....

TECHNICAL FEATURES:

The series is equipped with ceramic cartridge Ø25 mm, except built-in items that use ceramic cartridge Ø35 mm. Cartridges are produced by S.T.S.R. - Research Development Technical Office, www.stsr.it



15

NERO OPACO

MATT BLACK



SP600H15

14

BIANCO OPACO

MATT WHITE

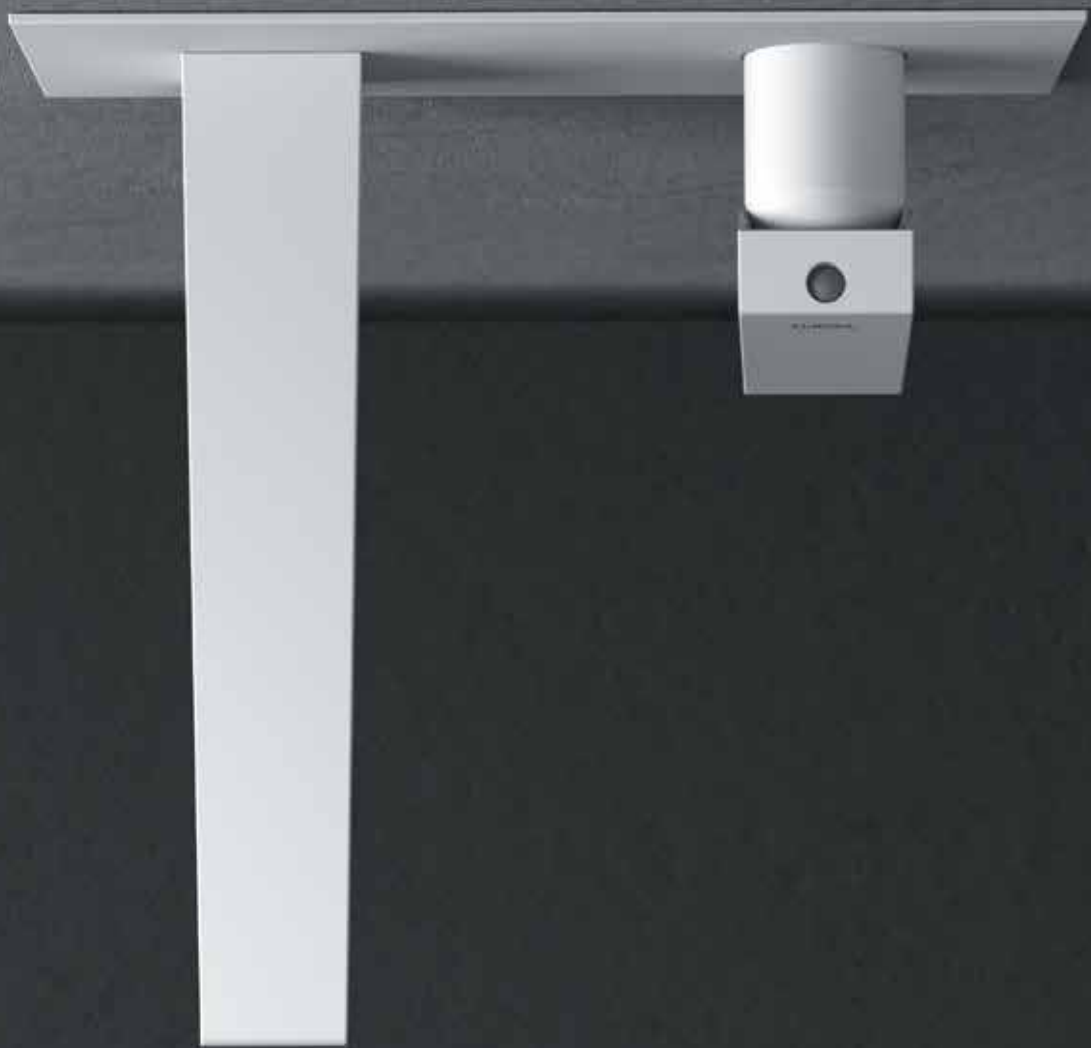

SP63214

AMBITION

TRILOGY

TIARA

TOKYO

SKYLINE

FUSION

DIVA

SPEED

SWING

JAX

DEKORA **SENSE** DESIGN

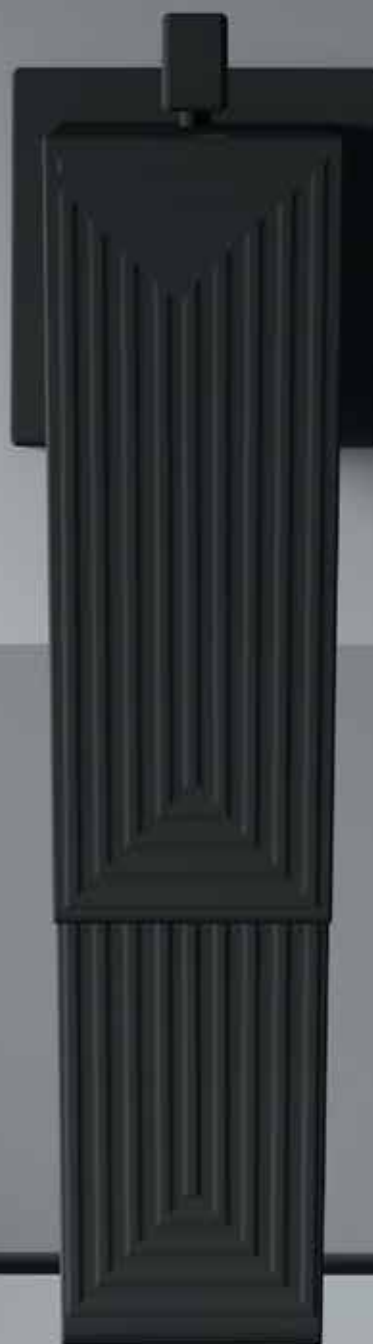

YE15

DECORO ELEGANCE SENSE NERO OPACO
MATT BLACK ELEGANCE SENSE DECORATION

SP605YE15

DEKORA **SENSE** DESIGN

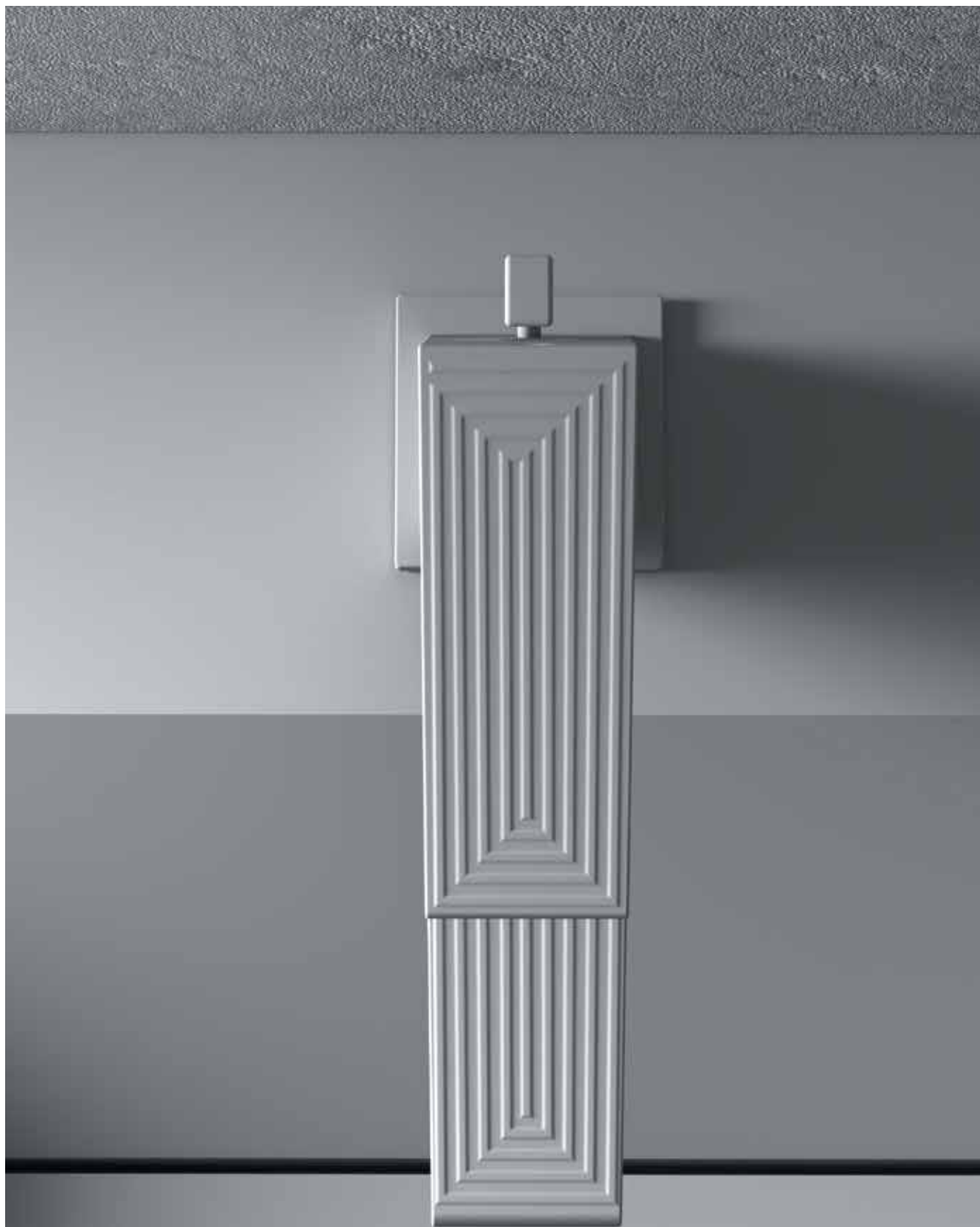

YE14

DECORO ELEGANCE SENSE BIANCO OPACO
MATT WHITE ELEGANCE SENSE DECORATION

SP605YE14

AMBITION

TRILOGY

TIARA

TOKYO

SKYLINE

FUSION

DIVA

SPEED

SWING

JAX

LAVABI - WASHBASIN MIXERS



SP605

Monocomando lavabo, con scarico.
Single-lever basin mixer, with pop-up waste.



SP606

Monocomando lavabo, senza scarico.
Single-lever basin mixer, without pop-up waste.



SP607

Monocomando lavabo alto, con scarico click-clack.
High basin mixer, with click-clack waste.

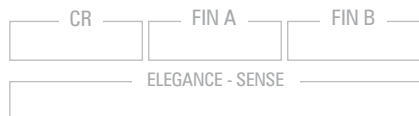

SP607B

Monocomando lavabo alto, senza scarico click-clack.
High basin mixer, without click-clack waste.

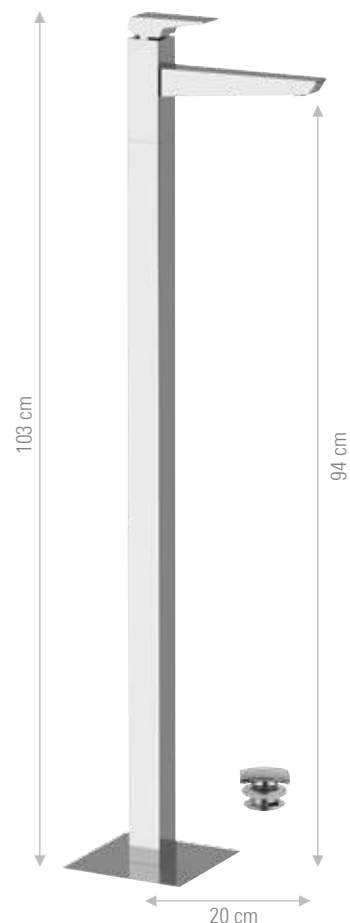

SP688

Miscelatore monocomando lavabo da pavimento con click-clack e troppo pieno.
Single-lever mixer floor mounting with click-clack and overflow.

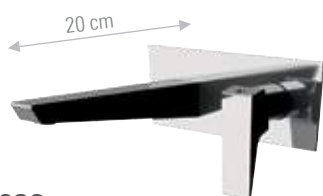

SP632

Miscelatore monocomando a incasso per lavabo, con piastra.
Single-lever built-in basin mixer, with wall flange.

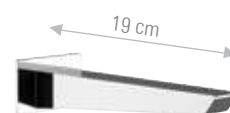
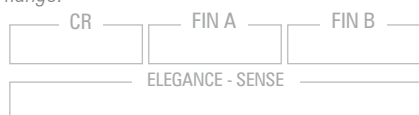

SP4704

Bocca incasso.
Built-in spout.



BOCCHE - SPOUTS

LAVABO BOX INCASSO - BUILT-IN BOX WASHBASIN MIXER



SP632KB

Miscelatore monocomando a incasso per lavabo, con piastra in ottone, bocca lunghezza 20 cm, da abbinare al box incasso.
Single-lever built-in basin mixer, with wall flange in brass, spout length 20 cm, to use with the built-in box.

DANBOX632

Box incasso per miscelatore monocomando a incasso per lavabo.
Built-in box for single-lever built-in basin mixer.

CR FIN A FIN B

ELEGANCE - SENSE

CR

BIDET



SP604

Monocomando bidet, con scarico.
Single-lever bidet mixer, with pop-up waste.

SP604B

Monocomando bidet, senza scarico.
Single-lever bidet mixer, without pop-up waste.

CR FIN A FIN B

ELEGANCE - SENSE

CR FIN A FIN B

ELEGANCE - SENSE



SP642

Miscelatore incasso per shut-off con doccetta shut-off, supporto doccia, presa acqua.
Built-in shut-off mixer set with shut-off, shower holder, water punch.

CR FIN A FIN B

ELEGANCE - SENSE

MISCELATORI VASCA E DOCCIA - SHOWER AND BATH MIXERS



SP610

Miscelatore vasca esterno, con kit doccia, flessibile 150 cm.
Exposed bath mixer, with shower kit, flexible 150 cm.

SP600

Miscelatore vasca esterno, con kit doccia, flessibile 120 cm.
Exposed bath mixer, with shower kit, flexible 120 cm.

SP600H

Miscelatore vasca esterno, senza kit doccia.
Exposed bath mixer, without shower kit..

CR FIN A FIN B

ELEGANCE - SENSE

CR FIN A FIN B

ELEGANCE - SENSE

CR FIN A FIN B

ELEGANCE - SENSE



SP631A

Monocomando doccia esterno, con kit doccia.
Exposed shower mixer, with shower kit..

CR	FIN A	FIN B
ELEGANCE - SENSE		



SP631

Monocomando doccia esterno, senza kit doccia.
Exposed shower mixer, without shower kit..

CR	FIN A	FIN B
ELEGANCE - SENSE		

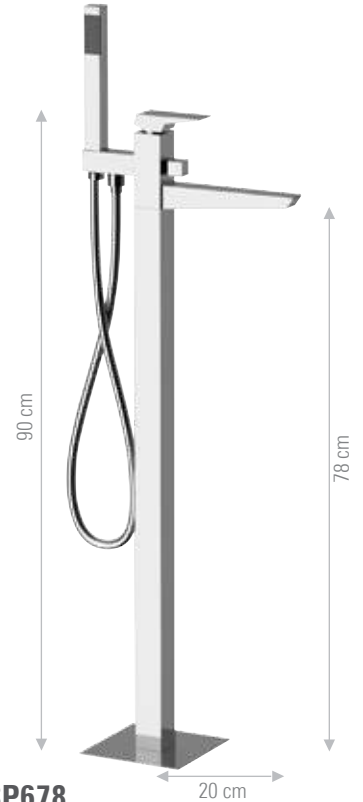

SP678

Miscelatore vasca da pavimento con deviatore e kit doccia.

Free standing bath mixer floor mounting with diverter and shower kit.

CR	FIN A	FIN B
ELEGANCE - SENSE		

□ □ □ 2 VIE - 2-WAY □ □ □



SP700D2

Set miscelatore a incasso a 2 vie per vasca/ doccia su piastra unica rettangolare, include miscelatore monocomando, deviatore a 2 uscite, bocca a muro. Da completare con una seconda uscita acqua.

2-way built-in mixer set for bathtub / shower on single rectangular plate, including single-lever mixer, 2-way diverter, wall spout. To be completed with a second water outlet.

CR	FIN A	FIN B
ELEGANCE - SENSE		

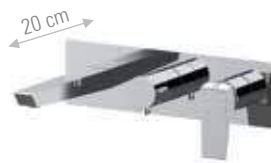

SP710D2

Set a incasso a 2 vie per vasca, include: miscelatore monocomando, deviatore a 2 uscite e bocca a muro su piastra unica rettangolare; set doccia su piastra quadrata con presa acqua, supporto integrato, doccetta in ottone e flessibile 150cm.

2-way built-in set for bathtub, on rectangular plates, including: single-lever mixer, 2-way diverter and wall spout 18 cm long on a single plate; water connection with shower holder, brass hand shower and 150cm flexible hose.

CR	FIN A	FIN B
ELEGANCE - SENSE		

□ □ □ 3 VIE - 3-WAY □ □ □



SP700D3

Set miscelatore a incasso a 3 vie per vasca/ doccia su piastra unica rettangolare, include miscelatore monocomando, deviatore a 3 uscite, bocca a muro. Da completare con una seconda e una terza uscita acqua.

3-way built-in mixer set for bathtub/shower on single rectangular plate, including single-lever mixer, 3-way diverter, wall spout. To be completed with second and third water outlets.

CR	FIN A	FIN B
ELEGANCE - SENSE		

INCASSI DOCCIA - BUILT-IN MIXERS

□ □ □ 1 VIA - 1-WAY □ □ □



SP602

Miscelatore incasso per doccia (articolo COMPLETO).
Built-in shower mixer (COMPLETE item).

CR	FIN A	FIN B
ELEGANCE - SENSE		

IN602C35

SOLO parti a incasso
Built-in parts ONLY.

CR	FIN A	FIN B
----	-------	-------

SP602EKIT

SOLO parti esterne.
Exposed parts ONLY.

CR	FIN A	FIN B
ELEGANCE - SENSE		

□ □ □ 2 VIE - 2-WAY □ □ □



SP612

Miscelatore incasso con deviatore per vasca/doccia (articolo COMPLETO).
Built-in bath/shower mixer with diverter (COMPLETE item).

CR	FIN A	FIN B
ELEGANCE - SENSE		

IN612C35

SOLO parti a incasso
Built-in parts ONLY.

CR	FIN A	FIN B
----	-------	-------

SP612EKIT

SOLO parti esterne.
Exposed parts ONLY.

CR	FIN A	FIN B
ELEGANCE - SENSE		



SP612D2

Miscelatore incasso con deviatore a 2 vie per vasca/doccia su piastra lusso ultrapiatta (articolo COMPLETO).
Built-in bath/shower mixer with 2-way diverter on luxury ultraslim plate (COMPLETE item).

CR	FIN A	FIN B
ELEGANCE - SENSE		



SP712D2

Set miscelatore a incasso a 2 vie per doccia su piastra unica rettangolare, include presa acqua con supporto, doccetta e flessibile 150 cm. Da completare con una 2° uscita.
2-way built-in shower mixer set on a single rectangular plate, including water connection with shower holder, hand shower and 150cm hose. To be completed with a 2nd water outlet.

CR	FIN A	FIN B
ELEGANCE - SENSE		

AMBITION

TRILOGY

TIARA

TOKYO

SKYLINE

FUSION

DIVA

SPEED

SWING

JAX

□ □ □ 3 VIE - 3-WAY □ □ □



SP612D3

Miscelatore incasso con deviatore a 3 vie per vasca/doccia , 1 entrata e 3 uscite (articolo COMPLETO).

Built-in bath/shower mixer with 3-way diverter, 1 inlet and 3 outlets (COMPLETE item).

CR	FIN A	FIN B
ELEGANCE - SENSE		



SP712D3

Set miscelatore a incasso a 3 vie per doccia su piastra unica rettangolare, include: miscelatore, deviatore a 3 uscite, presa acqua con supporto, doccetta in ottone e flessibile 150 cm. Da completare con una 2° ed una 3° uscita.

3-way built-in shower mixer set on a single rectangular plate, including: single-lever mixer, 3-way diverter, water connection with shower holder, brass hand shower and 150cm flexible hose. To be completed with a 2nd and 3rd water outlet.

CR	FIN A	FIN B
ELEGANCE - SENSE		

□ □ □ 4/5 VIE - 4/5-WAY □ □ □



SP612D4

Miscelatore incasso con deviatore a 4 vie per vasca/doccia , 1 entrata e 4 uscite (articolo COMPLETO).

Built-in bath/shower mixer with 4-way diverter, 1 inlet and 4 outlets (COMPLETE item).

CR	FIN A	FIN B
ELEGANCE - SENSE		



SP612D5

Miscelatore incasso con deviatore a 5 vie per vasca/doccia , 1 entrata e 5 uscite (articolo COMPLETO).

Built-in bath/shower mixer with 5-way diverter, 1 inlet and 5 outlets (COMPLETE item).

CR	FIN A	FIN B
ELEGANCE - SENSE		

— KIT WELLNESS - WELLNESS KIT —



SP614ZSS

Set doccia a incasso, composto da: miscelatore a incasso con deviatore SPEED, asta saliscendi rettangolare in ottone, attacco presa acqua a muro, soffione a parete in acciaio inox lucidato a specchio, doccetta quadrata in ottone a 1 funzione, flessibile 150cm.

Built-in shower set, including: built-in mixer with diverter SPEED, rectangular brass sliding rail, wall water connection, wall-mounted shower head in mirror-polished stainless steel, 1-function squared brass hand shower, 150cm flexible hose.



SP615ZSS

Set doccia a incasso, composto da: miscelatore a incasso con deviatore SPEED, attacco presa acqua a muro con supporto snodato per doccetta, soffione a parete in acciaio inox lucidato a specchio, doccetta quadrata in ottone a 1 funzione, flessibile 150cm.

Built-in shower set, including: built-in mixer with diverter SPEED, wall water connection with adjustable hand shower holder, wall-mounted shower head in mirror-polished stainless steel, 1-function squared brass hand shower, 150cm flexible hose.







SWING

SWING



SG605CR

SWING è una collezione di rubinetteria monocomando dalle linee moderne e arrotondate. I suoi miscelatori con base conica offrono una soluzione alternativa per lavabo e bidet che prevede la bocca alta e la leva laterale anche per l'ambiente bagno.

CARATTERISTICHE TECNICHE:

La serie è dotata di cartuccia a dischi ceramici, Ø 35 mm, prodotta da S.T.S.R. Studio Tecnico Sviluppo e Ricerche www.stsr.it

SWING is a collection of single-lever faucets with modern and rounded lines. Its mixers with a conical base offer an alternative solution for washbasins and bidets that includes a high spout and side lever also for the bathroom interior.

TECHNICAL FEATURES:

The series is equipped with ceramic cartridge, Ø 35 mm, produced by S.T.S.R. - Research Development Technical Office www.stsr.it



SG632PCR



SG610CR

AMBITION

TRILOGY

TIARA

TOKYO

SKYLINE

FUSION

DIVA

SPEED

SWING

JAX

15

NERO OPACO
MATT BLACK



SG605CC15

RP

RAME LUCIDO SPAZZOLATO

SHINY BRUSHED COPPER



AMBITION

TRILOGY

TIARA

TOKYO

SKYLINE

FUSION

DIVA

SPEED

SWING

JAX

SG605CCRP

LAVABI - WASHBASIN MIXERS



SG605CC

Monocomando lavabo, con scarico click-clack e troppo pieno.
Single-lever basin mixer, with click-clack waste and overflow.

CR FIN A FIN B



SG606N

Monocomando lavabo, senza scarico e senza foro sul corpo.
Single-lever basin mixer, without waste and without body hole.

CR FIN A FIN B

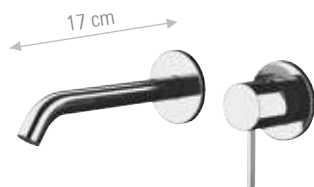

SG632P

Miscelatore monocomando da incasso per lavabo, su doppia piastra.
 Lunghezza bocca: 16 cm.
Built-in single-lever basin mixer with two separate plates. Spout length: 16 cm.

CR FIN A FIN B

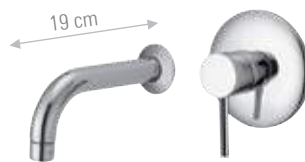

SG622CR

Miscelatore monocomando a incasso per lavabo, con bocca.
 Lunghezza bocca: 16 cm max.
Single-lever built-it basin mixer, with spout. Length spout: 16 cm max.

CR FIN A FIN B

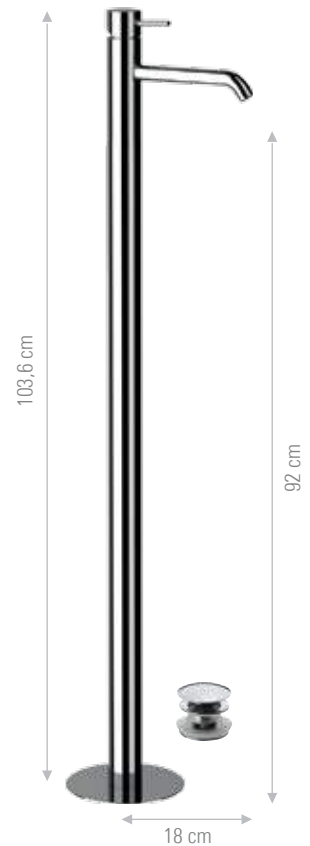

SG688

Miscelatore monocomando lavabo da pavimento con scarico click-clack e troppo pieno.
Single-lever mixer floor mounting with click-clack waste and overflow.

CR FIN A FIN B



SG655

Miscelatore monocomando a due fori per lavabo. Scarico non incluso.
Two-hole single-lever washbasin mixer. Waste not included.

CR FIN A FIN B



SG655L

Miscelatore monocomando lavabo due fori, con bocca L. Scarico non incluso.
Two holes single-lever washbasin mixer, with L spout. Waste not included.

CR FIN A FIN B

BIDET



SG604CC

Monocomando bidet, con scarico click-clack e troppo pieno.
Single-lever bidet mixer, with click-clack waste and overflow.

CR FIN A FIN B



SG604BN

Miscelatore bidet, senza scarico e senza foro sul corpo.
Bidet mixer, without waste and without body hole.

CR FIN A FIN B



SG645

Miscelatore incasso per shut-off, comprensivo di doccetta shut-off art. 1000DC, supporto doccia-presa acqua, tutto in ottone cromato e flessibile doccia cm 120.
Built-in shower mixer, including: shut-off art. 1000DC, shower holder-water punch on flange, all in c.p. brass and shower flexible cm 120.

CR FIN A FIN B

MISCELATORI VASCA E DOCCIA - SHOWER AND BATH MIXERS



SG610

Miscelatore vasca esterno, con kit doccia e flessibile da 150 cm.
Exposed bath mixer, with shower kit and 150 cm flexible.

CR FIN A FIN B

SG600H

Miscelatore vasca esterno, senza kit doccia.
Exposed bath mixer, without shower kit.

CR FIN A FIN B

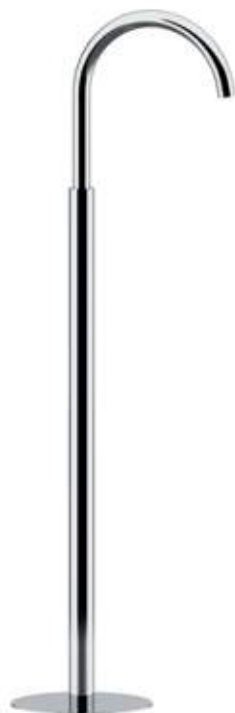

S204708

Bocca free-standing con installazione a pavimento per vasca.
Free-standing floor mounted spout for bathtub.

CR FIN A FIN B

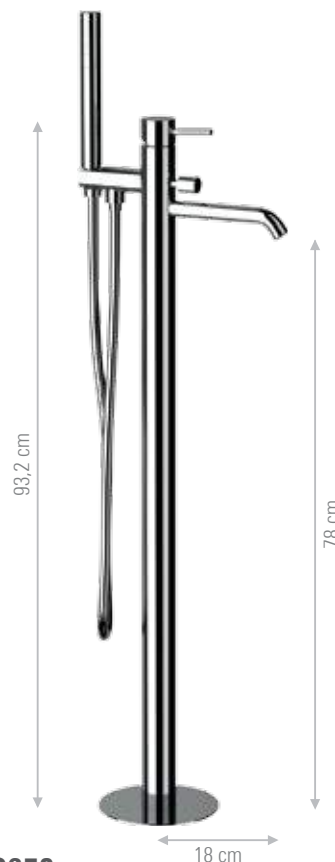

SG678

Miscelatore vasca da pavimento con deviatore e kit doccia.
Free standing bath mixer floor mounting with diverter and shower kit.

CR FIN A FIN B

INCASSI DOCCIA - BUILT-IN MIXERS

1 VIA - 1-WAY



SG602

Miscelatore incasso per doccia (articolo COMPLETO).
Built-in shower mixer (COMPLETE item).

CR FIN A FIN B

IN602C35

SOLO parti a incasso
Built-in parts ONLY.

CR FIN A FIN B

SG602EKIT

SOLO parti esterne.
Exposed parts ONLY.

CR FIN A FIN B



2 VIE - 2-WAY

SG612

Miscelatore incasso con deviatore per vasca/doccia (articolo COMPLETO).
Built-in bath/shower mixer with diverter (COMPLETE item).

CR FIN A FIN B

IN612C35

SOLO parti a incasso
Built-in parts ONLY.

CR FIN A FIN B

SG612EKIT

SOLO parti esterne.
Exposed parts ONLY.

CR FIN A FIN B

3 VIE - 3-WAY



SG612D2

Miscelatore incasso con deviatore a 2 vie per vasca/doccia su piastra lusso ultrapiatta (articolo COMPLETO).
Built-in bath/shower mixer with 2-way diverter on luxury ultraslim plate (COMPLETE item).

CR FIN A FIN B



SG612D3

Miscelatore incasso con deviatore a 3 vie per vasca/doccia, 1 entrata e 3 uscite (articolo COMPLETO).
Built-in bath/shower mixer with 3-way diverter, 1 inlet and 3 outlets (COMPLETE item).

CR FIN A FIN B

□ □ □ 4/5 VIE - 4/5-WAY □ □ □



SG612D4

Miscelatore incasso con deviatore a 4 vie per vasca/doccia , 1 entrata e 4 uscite (articolo COMPLETO).
Built-in bath/shower mixer with 4-way diverter, 1 inlet and 4 outlets (COMPLETE item).

CR FIN A FIN B



SG612D5

Miscelatore incasso con deviatore a 5 vie per vasca/doccia , 1 entrata e 5 uscite (articolo COMPLETO).
Built-in bath/shower mixer with 5-way diverter, 1 inlet and 5 outlets (COMPLETE item).

CR FIN A FIN B

COLONNE DOCCIA - SHOWER COLUMN



Set colonna doccia, composto da: miscelatore esterno per colonna SWING, colonna con fissaggio superiore regolabile e deviatore, flessibile 150cm, soffione ultra piatto in acciaio INOX lucidato a specchio, doccetta in abs a 1 funzione,
Shower column set, including: exposed mixer for column SWING, column with adjustable upper fixing and diverter, 150cm flexible hose, ultra-flat shower head in mirror-polished stainless steel, 1-function abs hand shower.

SG636X7820

Con soffione doccia Ø20cm
 With shower head Ø20cm

CR 15

SG636X7825

Con soffione doccia Ø25cm
 With shower head Ø25cm

CR 15

SG636X7830

Con soffione doccia Ø30cm
 With shower head Ø30cm

CR 15



Set colonna doccia, composto da: miscelatore esterno per colonna SWING, colonna telescopica ad altezza regolabile con deviatore, flessibile doccia 150cm, soffione ultra piatto in acciaio INOX lucidato a specchio, doccetta in abs a 1 funzione,
Shower column set, including: exposed mixer for column SWING, height-adjustable telescopic column with diverter, 150cm flexible hose, ultra-flat shower head in mirror-polished stainless steel, 1-function abs hand shower.

SG636A7820

Con soffione doccia 20x20cm
 With shower head 20x20cm

CR 15

SG636A7825

Con soffione doccia 25x25cm
 With shower head 25x25cm

CR 15

SG636A7830

Con soffione doccia 30x30cm
 With shower head 30x30cm

CR 15



Set colonna doccia, composto da: miscelatore esterno per colonna SWING, colonna con fissaggio superiore regolabile e deviatore, flessibile 150cm, soffione Ø 20cm in abs, doccetta in abs a 1 funzione, Shower column set, including: exposed mixer for column SWING, column with adjustable upper fixing and diverter, 150cm flexible hose, Ø 20cm abs shower head, 1-function abs hand shower.

SG636X8420

Con soffione doccia Ø20cm
With shower head Ø20cm

SG636X8425

Con soffione doccia Ø25cm
With shower head Ø25cm

SG636X8430

Con soffione doccia Ø30cm
With shower head Ø30cm



Set colonna doccia, composto da: miscelatore esterno per colonna SWING, colonna telescopica ad altezza regolabile con deviatore, flessibile doccia 150cm, soffione Ø 20cm in abs, doccetta in abs a 1 funzione.

Shower column set, including: exposed mixer for column SWING, height-adjustable telescopic column with diverter, 150cm flexible hose, Ø 20cm abs shower head, 1-function abs hand shower.

SG636A8420

Con soffione doccia 20x20cm
With shower head 20x20cm

SG636A8425

Con soffione doccia 25x25cm
With shower head 25x25cm

SG636A8430

Con soffione doccia 30x30cm
With shower head 30x30cm

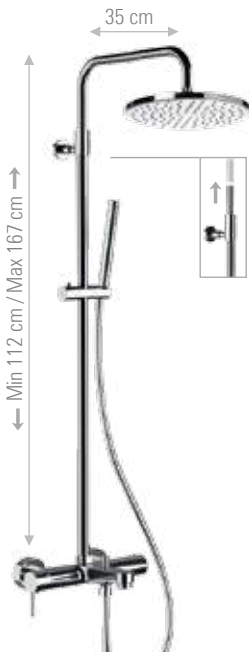

Set colonna a 3 vie, composto da: miscelatore con deviatore vasca/doccia esterno per colonna, colonna telescopica ad altezza regolabile, soffione in abs, doccetta in abs a 1 funzione, flessibile 150cm.

3-way bath/shower column set, including: exposed bath/shower mixer for column with diverter, height-adjustable telescopic column, abs shower head, 1-function abs hand shower, 150cm flexible hose.

SG636DA8420

Con soffione doccia Ø20cm
With shower head Ø20cm

SG636DA8425

Con soffione doccia Ø25cm
With shower head Ø25cm

SG636DA8430

Con soffione doccia Ø30cm
With shower head Ø30cm

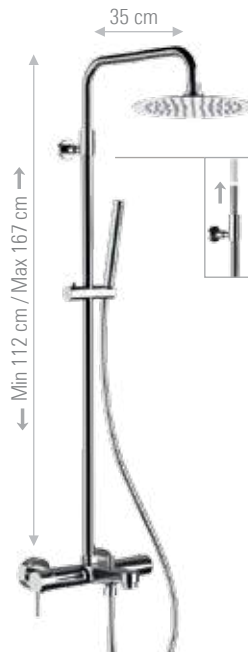

Set colonna a 3 vie, composto da: miscelatore con deviatore vasca/doccia esterno per colonna, colonna telescopica ad altezza regolabile, soffione ultra piatto in acciaio INOX lucidato a specchio, doccetta in abs a 1 funzione, flessibile 150cm.

3-way bath/shower column set, including: exposed bath/shower mixer for column with diverter, height-adjustable telescopic column, ultra-flat shower head in mirror-polished stainless steel, 1-function abs hand shower, 150cm flexible hose.

SG636DA7820

Con soffione doccia Ø20cm
With shower head Ø20cm

SG636DA7825

Con soffione doccia Ø25cm
With shower head Ø25cm

SG636DA7830

Con soffione doccia Ø30cm
With shower head Ø30cm

KIT WELLNESS - WELLNESS KIT



SG615Z8420

Con soffione doccia Ø20cm
With shower head Ø20cm

CR

SG615Z8425

Con soffione doccia Ø25cm
With shower head Ø25cm

CR

SG615Z8430

Con soffione doccia Ø30cm
With shower head Ø30cm

CR

Set doccia a incasso, composto da: miscelatore a incasso con deviatore SWING, attacco presa acqua a muro con supporto per doccetta, braccio a muro in ottone 30cm, soffione in abs, doccetta in abs a 1 funzione, flessibile 150cm.

Built-in shower set, including: built-in mixer with diverter SWING, wall water connection with hand shower holder, 30cm brass wall arm, abs shower head, 1-function abs hand shower, 150cm flexible hose.



SG614Z8420

Con soffione doccia Ø20cm
With shower head Ø20cm

CR

SG614Z8425

Con soffione doccia Ø25cm
With shower head Ø25cm

CR

SG614Z8430

Con soffione doccia Ø30cm
With shower head Ø30cm

CR

Set doccia a incasso, composto da: miscelatore a incasso con deviatore SWING, asta saliscendi, attacco presa acqua a muro, braccio a muro in ottone 30cm, soffione in abs, doccetta in abs a 1 funzione, flessibile 150cm.

Built-in shower set, including: built-in mixer with diverter SWING, sliding rail, wall water connection, 30cm brass wall arm, abs shower head, 1-function abs hand shower, 150cm flexible hose.



SG615ZL7820

Con soffione doccia Ø20cm
With shower head Ø20cm

CR 15

SG615ZL7825

Con soffione doccia Ø25cm
With shower head Ø25cm

CR 15

SG615ZL7830

Con soffione doccia Ø30cm
With shower head Ø30cm

CR 15

Set doccia a incasso, composto da: miscelatore a incasso con deviatore SWING, attacco presa acqua a muro con supporto per doccetta, braccio a muro in ottone 30cm, soffione ultra piatto in acciaio INOX lucidato a specchio, doccetta in abs a 1 funzione, flessibile 150cm.

Built-in shower set, including: built-in mixer with diverter SWING, wall water connection with hand shower holder, 30cm brass wall arm, ultra-flat shower head in mirror-polished stainless steel, 1-function abs hand shower, 150cm flexible hose.



SG614ZL7820

Con soffione doccia Ø20cm
With shower head Ø20cm

CR 15

SG614ZL7825

Con soffione doccia Ø25cm
With shower head Ø25cm

CR 15

SG614ZL7830

Con soffione doccia Ø30cm
With shower head Ø30cm

CR 15

Set doccia a incasso, composto da: miscelatore a incasso con deviatore SWING, asta saliscendi in ottone, attacco presa acqua a muro, braccio a muro in ottone 30cm, soffione ultra piatto in acciaio INOX lucidato a specchio, doccetta in abs a 1 funzione, flessibile 150cm.

Built-in shower set, including: built-in mixer with diverter SWING, brass sliding rail, wall water connection, 30cm brass wall arm, ultra-flat shower head in mirror-polished stainless steel, 1-function abs hand shower, 150cm flexible hose.

AMBITION

TRIOLOGY

TIARA

TOKYO

SKYLINE

FUSION

DIVA

SPEED

SWING

JAX



Set doccia a incasso, composto da: miscelatore a incasso con deviatore SWING, attacco presa acqua a muro con supporto per doccetta, braccio a muro in ottone 30cm, soffione in ottone, doccetta in ottone a 1 funzione, flessibile 150cm.
Built-in shower set, including: built-in mixer with diverter SWING, wall water connection with hand shower holder, 30cm brass wall arm, brass shower head, 1-function brass hand shower, 150cm flexible hose.

SG615ZOLCR

Con soffione doccia Ø20cm
 With shower head Ø20cm

CR FIN A FIN B

SG615ZOL9430CR

Con soffione doccia Ø30cm
 With shower head Ø30cm

CR FIN A FIN B



Set doccia a incasso, composto da: miscelatore a incasso con deviatore SWING, asta saliscendi in ottone, attacco presa acqua a muro, braccio a muro in ottone 30cm, soffione in ottone, doccetta in ottone a 1 funzione, flessibile 150cm.
Built-in shower set, including: built-in mixer with diverter SWING, brass sliding rail, wall water connection, 30cm brass wall arm, brass shower head, 1-function brass hand shower, 150cm flexible hose.

SG614ZOLCR

Con soffione doccia Ø20cm
 With shower head Ø20cm

CR FIN A FIN B

SG614ZOL9430CR

Con soffione doccia Ø30cm
 With shower head Ø30cm

CR FIN A FIN B



SG281M

Miscelatore monocomando per lavello, con canna alta girevole e doccetta estraibile con impugnatura a martello a due funzioni.
Single-lever sink mixer with high swivel spout and 2-functions pullout "hammer shaped" handle hand shower.

CR



SG274

Miscelatore monocomando lavello con bocca alta a "C" girevole.
Single-lever sink mixer with high movable "C" spout

CR FIN A FIN B



SG274U

Miscelatore monocomando lavello con bocca alta a "U" girevole
Single-lever sink mixer with high movable "U" spout

CR FIN A FIN B



SG284

Miscelatore monocomando per lavello con canna alta girevole e sistema di doccetta monofunzione estraibile.
Single-lever sink mixer with high movable spout and single-function system pull-out hand shower.

CR FIN A FIN B



SG284DJ

Miscelatore monocomando per lavello con canna alta girevole e doccetta estraibile a due funzioni
Single-lever sink mixer with high movable spout and 2-functions pull-out hand shower.

CR





JAX

JAX

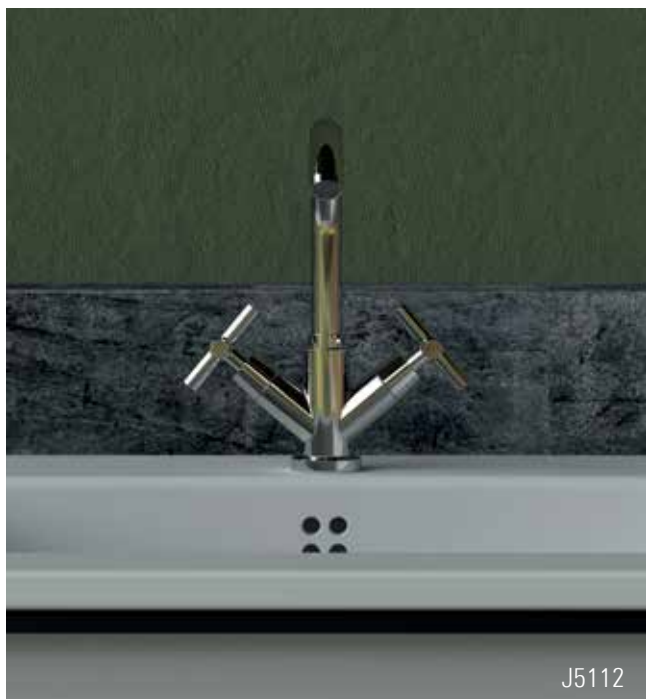

J5112



J6200

JAX è una collezione di rubinetteria bicomando dal design stilizzato e minimale. L'eleganza e la semplicità della maniglia a croce rende questa collezione molto versatile: nelle versioni cromate e dorate si combina perfettamente ad ambienti classici, mentre negli altri colori di finitura può caratterizzare ambientazioni dallo stile più moderno o industrial.

.....
CARATTERISTICHE TECNICHE:

La serie è dotata di vitone ceramico,
 prodotto da S.T.S.R. - Studio Tecnico Sviluppo e Ricerche
www.stsr.it



J4492

JAX is a collection of dual lever faucets with a stylized and minimal design. The elegance and simplicity of the cross handle makes this collection very versatile: its chromed and golden versions perfectly match classic interiors, while the other finishing colours can feature all the interiors with a modern or industrial style.

.....
TECHNICAL FEATURES:

*The series is equipped with ceramic headvalve,
 produced by S.T.S.R. - Research Development Technical Office www.stsr.it*



J5112

JAX

SWING

SPEED

DIVA

FUSION

SKYLINE

TOKYO

TIARA

TRILOGY

AMBITION

15

NERO OPACO
MATT BLACK



J502215



SM
OTTONE S.MARCO
S.MARCO BRASS

J7100SM

LAVABI E BIDET- WASHBASIN MIXERS AND BIDET



J5112
 Monoforo lavabo con scarico
 (Non vendibile in Germania)
 One hole washbasin mixer with pop-up waste
 (Not saleable in Germany).

CR FIN A FIN B



J5003
 Batteria lavabo con scarico.
 Washbasin set with pop-up waste.

CR FIN A FIN B



J5022
 Batteria lavabo da incasso.
 Concealed basin mixer.

CR FIN A FIN B



J5021
 Batteria lavabo da incasso su piastra unica.
 Concealed basin mixer on single flange.

CR FIN A FIN B



J6200
 Monoforo bidet con scarico.
 One hole bidet mixer with pop-up waste.

CR FIN A FIN B



J6302
 Batteria bidet con scarico.
 Three holes bidet set with pop-up waste.

CR FIN A FIN B



J9200
 Maniglia Jax.
 Jax handle.

CR FIN A FIN B



J4454
 Rubinetto arresto incasso 1/2".
 Built-in stop valve 1/2".

CR FIN A FIN B

MISCELATORI VASCA E DOCCIA - SHOWER AND BATH MIXERS



J4492
 Batteria bordo vasca quattro fori con canna con deviatore integrato nella bocca e doccetta estraibile in ottone cromato.
 Four holes deck bath set with diverter integrated on the casted spout, and pull-out hand shower in c.p. brass.

CR FIN A FIN B



J4491
 Batteria bordo vasca cinque fori con deviatore, bocca e doccetta estraibile in ottone cromato.
 Five holes deck bath set with diverter, casted spout, and pull-out hand shower in c.p. brass.

CR FIN A FIN B



J4498
 Batteria bordo vasca cinque fori con deviatore, bocca a cascata, doccetta estraibile in ottone cromato.
 Five holes deck bath set with diverter, waterfall spout, and pull-out hand shower in c.p. brass.

CR FIN A FIN B



J4302

Gruppo vasca esterno, con kit doccia, flessibile 150 cm.
Bathtub mixer, with shower kit, flexible 150 cm.

CR FIN A FIN B



J4433A

Gruppo doccia esterno, con kit doccia.
Wall-mounted shower mixer, with shower kit.

CR FIN A FIN B



J4440

Batteria vasca incasso con deviatore, set doccia e bocca.
Built-in bathtub mixer with diverter, shower kit and spout.

CR FIN A FIN B

J4300

Gruppo vasca esterno, con kit doccia, flessibile 120 cm.
Bathtub mixer, with shower kit, flexible 120 cm.

CR FIN A FIN B

J4433

Gruppo doccia esterno, senza kit doccia.
Wall-mounted shower mixer, without shower kit.

CR FIN A FIN B



J4441594

Batteria vasca/doccia incasso con soffione con getto pioggia e braccio cm 30 tutto in ottone cromato, deviatore e set doccia.
Built-in bath/shower mixer, shower head and brass cm 30 all in c-p- brass, with diverter and shower kit.

CR FIN A FIN B

CUCINA - KITCHEN



J7100

Monoforo lavello con bocca girevole.
One-hole sink mixer with movable spout.

CR FIN A FIN B

COLONNE DOCCIA - SHOWER COLUMN



J4436X594CR

Set colonna doccia, composto da: gruppo doccia esterno per colonna Jax, colonna con fissaggio superiore regolabile e deviatore, flessibile 150cm, soffione Ø 20 cm in ottone, doccetta in ottone a 1 funzione,
Shower column set, including: exposed mixer for column JAX, column with adjustable upper fixing and diverter, 150cm flexible hose, Ø 20cm brass shower head, 1-function brass hand shower.

CR FIN A FIN B



J4436A594CR

Set colonna doccia, composto da: gruppo doccia esterno per colonna Jax, colonna telescopica ad altezza regolabile con deviatore, flessibile doccia 150cm, soffione Ø 20 cm in ottone, doccetta in ottone a 1 funzione.
Shower column set, including: exposed mixer for column JAX, height-adjustable telescopic column with diverter, 150cm flexible hose, Ø 20cm brass shower head, 1-function brass hand shower.

CR FIN A FIN B

STEEL COLLECTION



SSTX632P

TOKYO STEEL pag 190

WELLNESS STEEL pag 198

ACCESSORIES STEEL pag 212

KITCHEN STEEL pag 216



SS3
Rame Spazzolato PVD
Brushed Copper PVD

SS1
Nero Spazzolato PVD
Brushed Black PVD

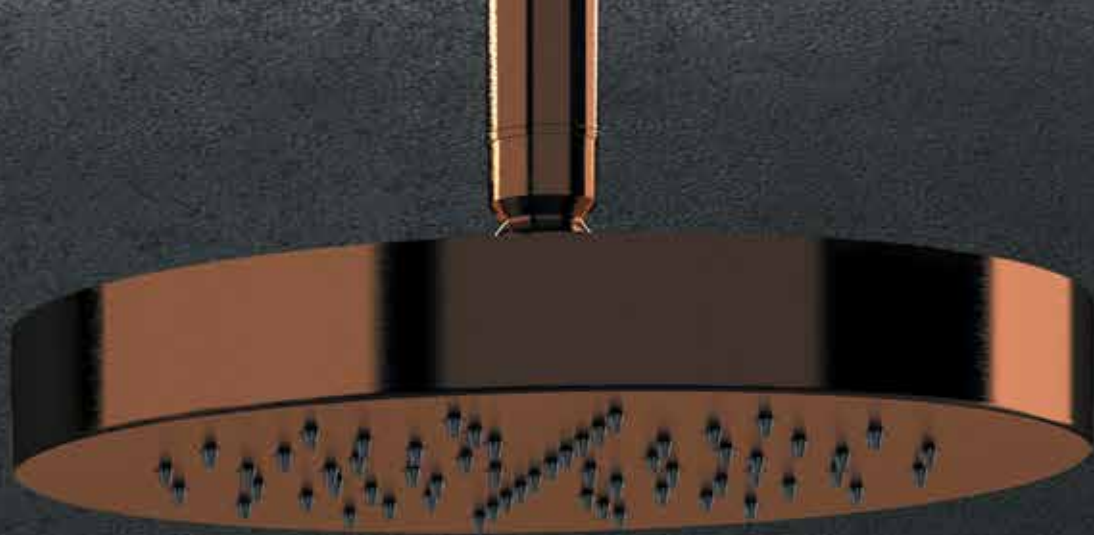

FINITURE PVD

Tutti gli articoli della collezione STEEL COLLECTION sono realizzati in acciaio INOX con effetto spazzolato e, dove segnalato, possono essere personalizzati con i nuovi colori in PVD (Physical Vapour Deposition): Nero spazzolato PVD, Ottone spazzolato PVD e Rame spazzolato PVD. Queste finiture speciali garantiscono un colore resistente e stabile nel tempo, arricchendo il design di interni di una sfumatura moderna dal forte impatto visivo.

PVD FINISHING

All the items included in the STEEL COLLECTION are made of stainless steel with a brushed effect and, where indicated, can be customized with the new PVD (Physical Vapor Deposition) colours: brushed black PVD, brushed brass PVD and brushed copper PVD. These special finishes guarantee a resistant and stable colour over time, enriching interior design with modern shades and great visual impact.



SS2
Ottone Spazzolato PVD
Brushed Brass PVD

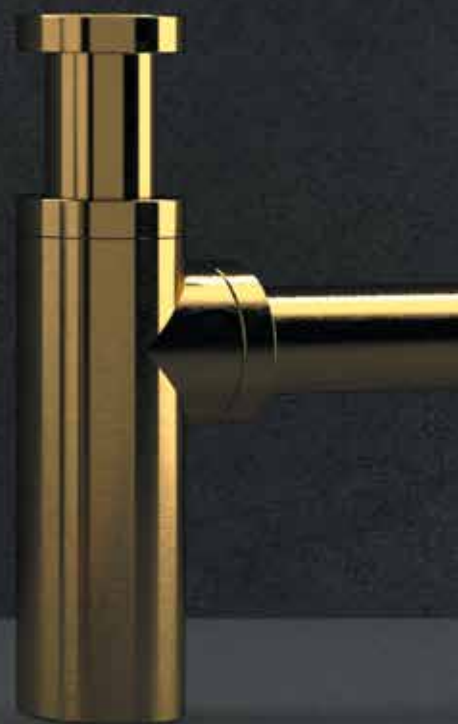







SSTX606N

La collezione TOKYO STEEL viene interamente prodotta in acciaio INOX con effetto spazzolato ed include in un design essenziale tutto il fascino estetico e pratico di questo materiale.

Le forme di questa rubinetteria sono slanciate, semplici e morbide, come la curvatura della bocca di erogazione che accompagna dolcemente il fluire dell'acqua.

TOKYO STEEL collection is entirely made in stainless steel, enclosing in an essential design all the aesthetic and practical appeal of this material.

The shapes of this faucets are slender, simple and smooth, like the curvature of the mouths that gently accompanies the water flow.

.....

CARATTERISTICHE TECNICHE:

La serie è dotata di cartuccia a dischi ceramici, Ø 25 mm, vasca ed incassi Ø 35 mm prodotte da S.T.S.R. – Studio Tecnico Sviluppo e Ricerche
www.stsr.it

.....

TECHNICAL FEATURES:

The series is equipped with ceramic cartridge Ø25 mm, except for bathtub and built-in items that use ceramic cartridge Ø35 mm, produced by S.T.S.R. - Research Development Technical Office - www.stsr.it

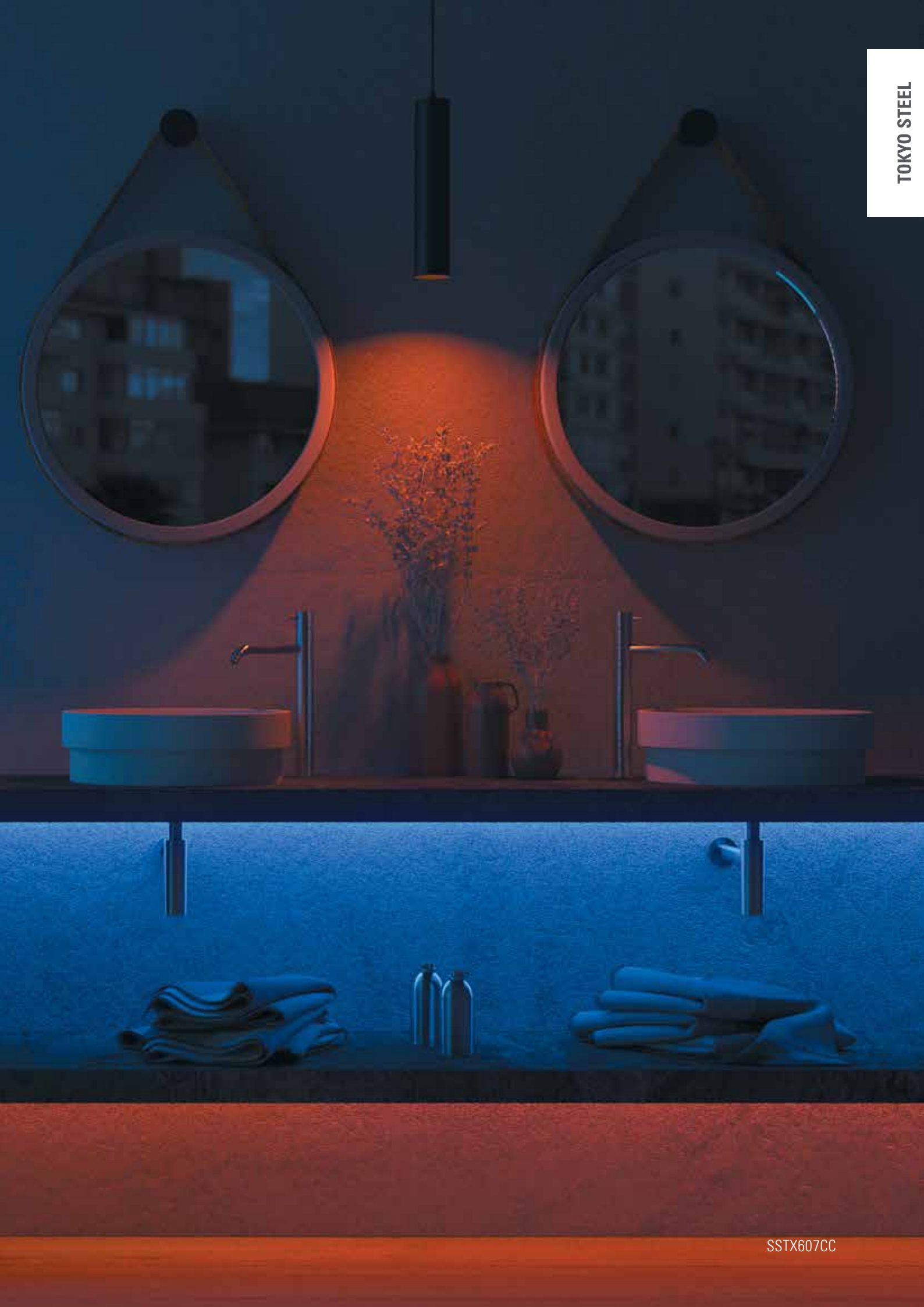

OPZIONI DI FINITURA - FINISHING OPTIONS

NB: il codice identificativo della finitura è all'inizio del codice prodotto.
 NB: finishing reference code is at the beginning of the product code.



LAVABI E BIDET - WASHBASIN & BIDET MIXERS



SSTX605CC

Monocomando lavabo con scarico clickclack e senza foro sul corpo, acciaio INOX spazzolato.
 Single-lever basin mixer with click-clack waste and without body hole, brushed stainless steel.



SSTX605XC

Monocomando lavabo, bocca lunga, con scarico clickclack e senza foro sul corpo, acciaio INOX spazzolato.
 Single-lever basin mixer, long spout, with click-clack waste and without body hole, brushed stainless steel.



SSTX607CC

Monocomando lavabo alto con scarico clickclack e senza foro sul corpo, acciaio INOX spazzolato.
 High basin mixer with click-clack waste and without body hole, brushed stainless steel.



SSTX606N

Monocomando lavabo senza scarico e senza foro sul corpo, acciaio INOX spazzolato.
 Single-lever basin mixer without waste and without body hole, brushed stainless steel.



SSTX606XN

Monocomando lavabo, bocca lunga, senza scarico e senza foro sul corpo, acciaio INOX spazzolato.
 Single-lever basin mixer, long spout, without waste and without body hole, brushed stainless steel.



SSTX607BN

Monocomando lavabo alto senza scarico e senza foro sul corpo, acciaio INOX spazzolato.
 High basin mixer without waste and without body hole, brushed stainless steel.





SSTX604CC

Monocomando bidet con scarico click-clack e senza foro sul corpo, acciaio INOX spazzolato.
Single-lever bidet mixer with click-clack waste and without body hole, brushed stainless steel.

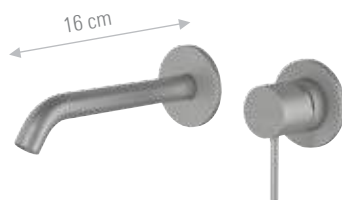

SSTX632P

Miscelatore monocomando a incasso per lavabo, acciaio INOX spazzolato.
 Lunghezza bocca: 16 cm.
Single-lever built-it basin mixer, brushed stainless steel. Spout length: 16 cm.



SSTX604BN

Monocomando bidet senza scarico e senza foro sul corpo, acciaio INOX spazzolato.
Single-lever bidet mixer without waste and without body hole, brushed stainless steel.

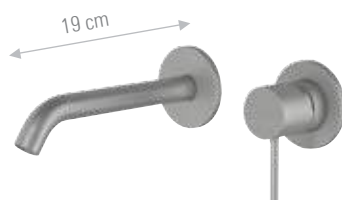

SSTX632PL

Miscelatore monocomando a incasso per lavabo, acciaio INOX spazzolato.
 Lunghezza bocca: 19 cm.
Single-lever built-it basin mixer, brushed stainless steel. Spout length: 19 cm.

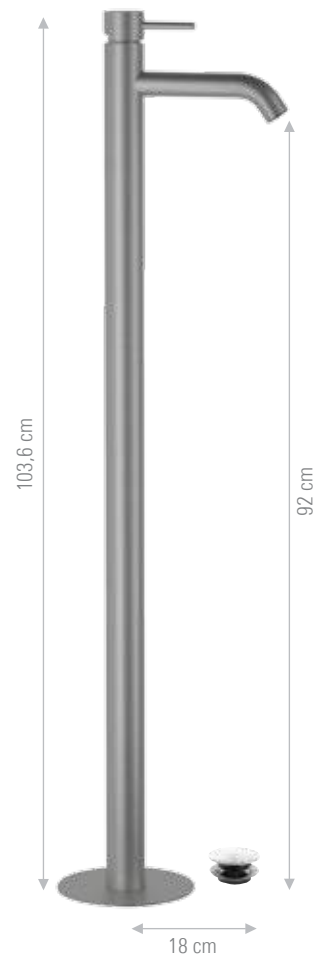

SSTX688

Miscelatore monocomando lavabo da pavimento con scarico click-clack e troppo pieno, acciaio INOX spazzolato.
Single-lever mixer floor mounting with click-clack waste and overflow, brushed stainless steel.



MISCELATORI VASCA E DOCCIA - SHOWER AND BATH MIXERS

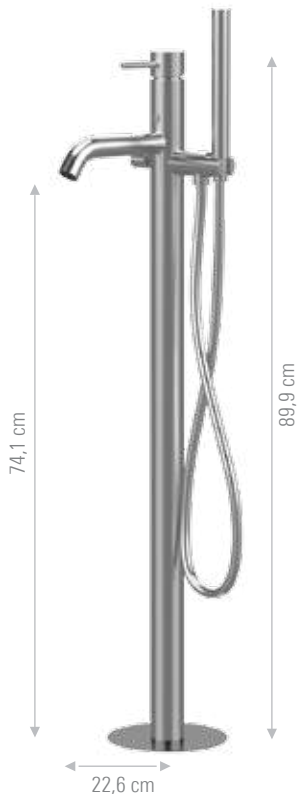

SSTX678

Miscelatore vasca da pavimento con deviatore e kit doccia, acciaio INOX spazzolato.
Free standing bath mixer floor mounting with diverter and shower kit, brushed stainless steel.

INOX PVD

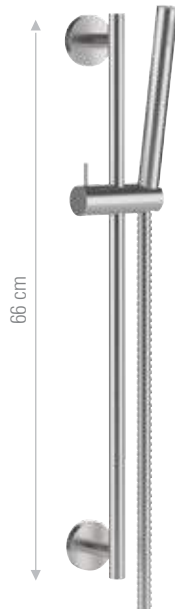

SSA335435

SKit saliscendi minimale in acciaio INOX spazzolato con doccetta ad 1 funzione e flessibile 150cm.
Minimal sliding rail set in brushed stainless steel with 1 function handshower and 150 cm flexible hose.

INOX PVD



SSA335516

Saliscendi minimale tutto in acciaio inox spazzolato 60 cm, con flessibile incluso, in acciaio inox.
Stainless steel minimal sliding rail set all in brushed stainless steel 60 cm, including flexible hose.

INOX PVD



SSTXT610

Miscelatore monocomando termostatico vasca esterno in acciaio INOX spazzolato con deviatore, kit doccia con flessibile cm 150 e doccetta a una funzione.
Exposed thermostatic brushed stainless steel single-lever bath mixer with diverter, shower kit with 150 cm flexible hose and one function minimal handshower.

INOX PVD



SSTXT600H

Miscelatore monocomando termostatico vasca esterno in acciaio INOX spazzolato con deviatore, senza kit doccia.
Exposed thermostatic brushed stainless steel single-lever bath mixer, without shower kit.

INOX PVD

BOCCHIE ED INCASSI DOCCIA - SPOUTS & BUILT-IN SHOWER MIXERS

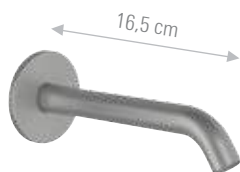

SSTX4704

Bocca incasso, acciaio INOX spazzolato.
Lunghezza bocca: 16,5cm.
Built-in spout, brushed stainless steel.
Spout length: 16,5 cm.

INOX PVD

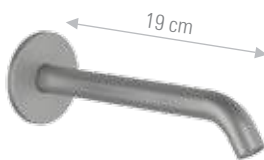

SSTX4704L

Bocca incasso, acciaio INOX spazzolato.
Lunghezza bocca: 19cm
Built-in spout, brushed stainless steel.
Spout length: 19 cm.

INOX PVD



SSTXT612Q

Miscelatore doccia incasso termostatico con deviatore a pulsante e rosone rettangolare, acciaio INOX spazzolato.
Built-in thermostatic shower mixer with pushbutton diverter and rectangular flange, brushed stainless steel.

INOX PVD



SSTX602

Miscelatore doccia incasso, acciaio INOX spazzolato.
Built-in shower mixer, brushed stainless steel.

INOX PVD



SSTX612D2P

Miscelatore monocomando a incasso per doccia con deviatore a 2 vie, su doppia piastra, acciaio INOX spazzolato.
Single-lever built-in shower mixer with 2-way diverter, on double flange, brushed stainless steel.

INOX PVD



SSTX612D3P

Miscelatore monocomando a incasso per doccia con deviatore a 3 vie, su doppia piastra, acciaio INOX spazzolato.
Single-lever built-in shower mixer with 3-way diverter, on double flange, brushed stainless steel.

INOX PVD





WELLNESS STEEL

WELLNESS STEEL

SOFFIONI DESIGN A PARETE - WALL DESIGN SHOWER HEADS



SSA578LP

Soffione a parete modello lampada con 3 aeratori con getto a pioggia, in acciaio inox spazzolato.
 Misure: Ø80 x 160 mm. Rosetta a muro Ø80 x 15 mm.
Lamp-shape shower head with 3 rain jet aerators, in brushed stainless steel. Size: Ø80 x 160 mm. Wall flange Ø80 x 15 mm.

INOX
 PVD



SSA578LPCA

Soffione a parete modello lampada con getto a cascata, in acciaio inox spazzolato.
 Misure: Ø80 x 160 mm. Rosetta a muro Ø80 x 15 mm.
Lamp-shape shower head with waterfall jet, in brushed stainless steel. Size: Ø80 x 160 mm. Wall flange Ø80 x 15 mm.

INOX
 PVD



SSA578LPN

Soffione a parete modello lampada con 3 aeratori con getto nebulizzato, in acciaio inox spazzolato.
 Misure: Ø80 x 160 mm. Rosetta a muro Ø80 x 15 mm.
Lamp-shape shower head with 3 nebulised jet aerators, in brushed stainless steel. Size: Ø80 x 160 mm. Wall flange Ø80 x 15 mm.

INOX
 PVD



SSA578LP - SSA578LPCA



SS1A578LP

Soffione a parete modello lampada con 3 aeratori con getto a pioggia, in acciaio inox, finitura **nero spazzolato PVD**. Misure: Ø80 x 160 mm. Rosetta a muro Ø80 x 15 mm.

*Lamp-shape shower head with 3 rain jet aerators, in stainless steel, **brushed black PVD** finish. Size: Ø80 x 160 mm. Wall flange Ø80 x 15 mm.*

PVD



SS2A578LP

Soffione a parete modello lampada con 3 aeratori con getto a pioggia, in acciaio inox, finitura **ottone spazzolato PVD**. Misure: Ø80 x 160 mm. Rosetta a muro Ø80 x 15 mm.

*Lamp-shape shower head with 3 rain jet aerators, in stainless steel, **brushed brass PVD** finish. Size: Ø80 x 160 mm. Wall flange Ø80 x 15 mm.*

PVD



SS3A578LP

Soffione a parete modello lampada con 3 aeratori con getto a pioggia, in acciaio inox, finitura **rame spazzolato PVD**. Misure: Ø80 x 160 mm. Rosetta a muro Ø80 x 15 mm.

*Lamp-shape shower head with 3 rain jet aerators, in stainless steel, **brushed copper PVD** finish. Size: Ø80 x 160 mm. Wall flange Ø80 x 15 mm.*

PVD



SS1A578LP - SS3A578LP - SS2A578LP

SOFFIONI DESIGN A SOFFITTO - CEILING DESIGN SHOWER HEADS



SSA578PECM10

Soffione doccia a soffitto, Ø 5 cm x 10 cm, areatore con getto a pioggia, acciaio INOX spazzolato.

Ceiling shower head, Ø 5 cm x 10 cm, with rain jet aerator, brushed stainless steel.



SSA578PECM15

Soffione doccia a soffitto, Ø 5 cm x 15 cm, areatore con getto a pioggia, acciaio INOX spazzolato.

Ceiling shower head, Ø 5 cm x 15 cm, with rain jet aerator, brushed stainless steel.



SSA578PECM20

Soffione doccia a soffitto, Ø 5 cm x 20 cm, areatore con getto a pioggia, acciaio INOX spazzolato.

Ceiling shower head, Ø 5 cm x 20 cm, with rain jet aerator, brushed stainless steel.

INOX PVD

INOX PVD

INOX PVD



SS3A578PECM10 - SS1A578PECM20 - SS2A578PECM15



SSA578PELCM10

Soffione doccia, Ø 5 cm x 10 cm, braccio a soffitto 10 cm con rosone, areatore con getto a pioggia, acciaio INOX spazzolato.

Shower head, Ø 5 cm x 10 cm, 10cm ceiling arm with plate, rain jet aerator, brushed stainless steel.

INOX

PVD



SSA578PELCM15

Soffione doccia, Ø 5 cm x 15 cm, braccio a soffitto 10 cm con rosone, areatore con getto a pioggia, acciaio INOX spazzolato.

Shower head, Ø 5 cm x 15 cm, 10cm ceiling arm with plate, rain jet aerator, brushed stainless steel.

INOX

PVD



SSA578PELCM20

Soffione doccia, Ø 5 cm x 20 cm, braccio a soffitto 10 cm con rosone, areatore con getto a pioggia, acciaio INOX spazzolato.

Shower head, Ø 5 cm x 20 cm, 10cm ceiling arm with plate, rain jet aerator, brushed stainless steel.

INOX

PVD



SSA578PELCM10 - SSA578PELCM20 - SSA578PELCM15

SOFFIONI A SOFFITTO EASY FIX - EASY FIX CEILING SHOWER HEAD



SSA578EFCM34

Soffione doccia a soffitto in acciaio INOX spazzolato Ø34 cm, con sistema di fissaggio EASY FIX, con getti anticalcare.
Ceiling shower head in brushed stainless steel Ø34 cm, with EASY FIX fixing system, with anti-limescale jets.



SSA578EFCM44

Soffione doccia a soffitto in acciaio INOX spazzolato Ø44 cm, con sistema di fissaggio EASY FIX, con getti anticalcare.
Ceiling shower head in brushed stainless steel Ø44 cm, with EASY FIX fixing system, with anti-limescale jets.



SSA579EFCM34

Soffione doccia a soffitto in acciaio INOX spazzolato 34x34 cm, con sistema di fissaggio EASY FIX, con getti anticalcare.
Ceiling shower head in brushed stainless steel 34x34 cm, with EASY FIX fixing system, with anti-limescale jets.



SSA579EFCM44

Soffione doccia a soffitto in acciaio INOX spazzolato 44x44 cm, con sistema di fissaggio EASY FIX, con getti anticalcare.
Ceiling shower head in brushed stainless steel 44x44 cm, with EASY FIX fixing system, with anti-limescale jets.



APPLICAZIONE A SOFFITTO "EASY FIX" - "EASY FIX" CEILING APPLICATION

Per questa tipologia di soffione e con questo specifico sistema di fissaggio sono previste quattro molle per ogni soffione.

For this specific shower-head with this specific mounting system, four springs are installed on each head.

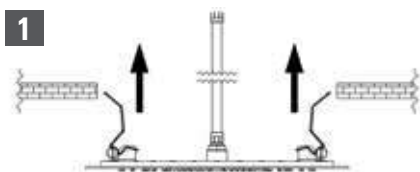

Nell'immagine 1 si evidenzia il primo movimento necessario: caricare due molle vicine tra loro mettendole quasi in posizione verticale rispetto al soffione ed inserirle all'interno del foro precedentemente preparato.
 Rilasciare le stesse delicatamente.

In picture 1, you shall see the first needed movement to activate them: Spring-load two springs next to each other placing them almost vertically and insert them in the hole in the ceiling; Release them gently;

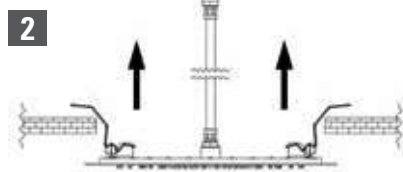

Mantenendo il soffione leggermente inclinato procedere caricando ed inserendo le rimanenti due molle come da immagine 2.

While keeping the showerhead slightly inclined, proceed by spring-loading and inserting the two other springs as shown in picture 2.

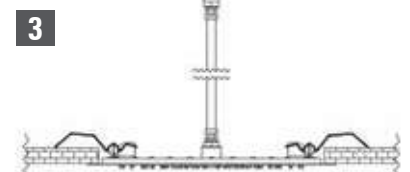

A questo punto rilasciare delicatamente le molle alla loro naturale tensione e, trattenendo esternamente il soffione, accompagnare lo stesso verso il totale appoggio al soffitto come da immagine 3.

Now release the springs back to their natural tension and, while holding the head from outside, guide it to its final position as shown in picture 3.

SOFFIONI A PARETE - WALL SHOWER HEADS



SSA562

Soffione doccia a parete 50x20cm, in acciaio INOX spazzolato, con getti anticalcare.
Wall-mounted shower head 50x20 cm, in brushed stainless steel, with anti-limescale jets.

SSA563

Soffione doccia ultrapiatto a parete, 50x22 cm, in acciaio INOX spazzolato, getti anticalcare.
Wall-mounted ultra-flat shower head, 50x22 cm, in brushed stainless steel, anti-limescale jets.

INOX

PVD

INOX

PVD



SSA562CA

Soffione doccia a parete 50x20cm, in acciaio INOX spazzolato, 2 funzioni: pioggia e cascata. Getti anticalcare.
Wall-mounted shower head 50x20 cm, in brushed stainless steel, 2 functions: rain and waterfall. Anti-limescale jets.

SSA563CA

Soffione doccia ultrapiatto 50x22 cm, a parete in acciaio INOX spazzolato, 2 funzioni: getto a pioggia e cascata. Getti anticalcare.
Wall-mounted ultra-flat shower head, 50x22 cm, in brushed stainless steel, 2 functions: rain and waterfall. Anti-limescale jets.

SSA566CA

Soffione doccia a parete 50x20cm, 2 funzioni: a pioggia cascata, acciaio INOX spazzolato.
Wall shower head, 2 functions: rain jet and waterfall, 50x20 cm, brushed stainless steel.

INOX PVD

INOX PVD

INOX PVD

SOFFIONI PER BRACCIO - ARM MOUNTING SHOWER HEADS



Soffione a pioggia quadrato per braccio, altezza 3 cm, acciaio INOX spazzolato.
Squared shower head for arm mounting, height 3cm, brushed stainless steel.



Soffione a pioggia tondo per braccio, diametro, altezza 3 cm, acciaio INOX spazzolato.
Round shower head for arm mounting, height 3cm, brushed stainless steel.

SSA579H3CM22

Soffione da 22,5x22,5 cm.
Head shower 22,5x22,5 cm.

INOX PVD

SSA578H3CM22

Soffione da Ø22,5 cm.
Head shower Ø22,5 cm.

INOX PVD

SSA579H3CM32

Soffione da 32,5x32,5 cm.
Head shower 32,5x32,5 cm.

INOX PVD

SSA578H3CM32

Soffione da Ø32,5 cm.
Head shower Ø32,5 cm.

INOX PVD

STEEL COLLECTION



Soffione doccia quadrato ultrapiatto, acciaio INOX spazzolato.
Ultra slim brushed stainless steel shower head.

SSA579CM20

Soffione da 20x20 cm.
Head shower 20x20 cm.

INOX PVD

SSA579CM25

Soffione da 25x25 cm.
Head shower 25x25 cm.

INOX PVD

SSA579CM30

Soffione da 30x30 cm.
Head shower 30x30 cm.

INOX PVD

SSA579CM40

Soffione da 40x40 cm.
Head shower 40x40 cm.

INOX PVD



Soffione doccia tondo ultrapiatto, acciaio INOX spazzolato.
Ultra slim brushed stainless steel shower head.

SSA578CM20

Soffione da Ø20 cm.
Head shower Ø20 cm.

INOX PVD

SSA578CM25

Soffione da Ø25 cm.
Head shower Ø25 cm.

INOX PVD

SSA578CM30

Soffione da Ø30 cm.
Head shower Ø30 cm.

INOX PVD

SSA578CM40

Soffione da Ø40 cm.
Head shower Ø40 cm.

INOX PVD

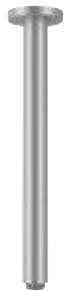

Braccio doccia tondo da soffitto, acciaio INOX spazzolato. cm: 10, 20, 30.
Ceiling round shower arm, in brushed stainless steel. cm: 10, 20, 30.

SSA557CM10

Lunghezza 10 cm.
Lenght 10 cm.

INOX PVD

SSA557CM20

Lunghezza 20 cm.
Lenght 20 cm.

INOX PVD

SSA557CM30

Lunghezza 30 cm.
Lenght 30 cm.

INOX PVD



SSA555LCM30

Braccio doccia tondo da parete, acciaio INOX spazzolato.
Wall round shower arm, in brushed stainless steel.

INOX PVD

BODY JETS



SSOXJETX

Body jet quadrato 5x5 cm, in acciaio INOX spazzolato per sistema doccia, anticalcare, con snodo.
Squared body jet 5x5 cm, in brushed stainless steel for shower systems, antilimestone, with ball-joint.

INOX PVD



SSSJETX

Body jet rotondo Ø5 cm, in acciaio INOX spazzolato per sistema doccia, anticalcare, con snodo.
Round body jet Ø5 cm, in brushed stainless steel for shower systems, antilimestone, with ball-joint.

INOX PVD

DOCCETTE - HAND SHOWER



Doccetta a L ad 1 funzione, acciaio INOX spazzolato.
1-function L-shaped hand shower, brushed stainless steel.

SSA435AP

Senza scatola - Without box

INOX PVD

SSA435APS

Con scatola - With box

INOX PVD



Doccetta rettangolare piatta ad 1 funzione, acciaio INOX spazzolato.
1-function flat rectangular hand shower, brushed stainless steel.

SSA494

Senza scatola - Without box

INOX PVD

SSA494S

Con scatola - With box

INOX PVD

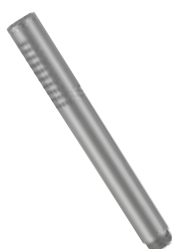

Doccetta tonda ad 1 funzione, acciaio INOX spazzolato.
1-function rounded hand shower, brushed stainless steel.

SSA435

Senza scatola - Without box

INOX PVD

SSA435S

Con scatola - With box

INOX PVD



SSA546435

Set doccia minimale in acciaio INOX spazzolato composto da: presa acqua con supporto lusso, doccetta tonda ad 1 funzione e flessibile in pvc color grigio acciaio 150cm.

Minimal brushed stainless steel shower set including: water punch with shower holder, 1-function rounded handshower, 150cm flexible hose in steel grey coloured pvc.

INOX PVD

SUPPORTI DOCCIA - SHOWER HOLDER



SSA546

Presa acqua a muro minimale in acciaio INOX con supporto doccetta per flessibile con attacco conico.
Minimal wall water intake, stainless steel, with shower holder for conical nut flexible.

INOX PVD



SSA520

Attacco presa acqua da 1/2 minimale in acciaio INOX.
Stainless steel wall connector, minimal type 1/2 for shower.

INOX PVD



SSA542

Presa acqua a muro minimale in acciaio INOX con supporto doccetta shut-off per flessibile con attacco conico.
Minimal wall water intake, stainless steel, with shut-off shower holder for conical nut flexible.

INOX PVD



SSA537

Supporto fisso minimale in acciaio INOX per flessibile con attacco conico.
Minimal shower holder brushed stainless steel, for conical nut flexible.

INOX PVD

SHUT-OFF



ON / OFF

SS1036

Set doccetta igienica shut-off in acciaio INOX con flessibile 120cm, attacco G1" 1/2.
Stainless steel shut-off handshower with cm 120 flexible hose, G1"1/2 connection.



SSTX642P

Set doccetta igienica shut-off in acciaio INOX con flessibile 120cm, attacco G1"1/2, incasso con miscelazione, cartuccia Ø25.
Stainless steel shut-off set with handshower, cm 120 flexible hose, G1"1/2 connection, Ø25 cartridge built-in shut-off mixer.



SS1006DC

Solo doccetta igienica shut-off in acciaio INOX 316L.
Stainless steel shut-off handshower, stainless steel 316L.



IDROSCOPINI - HYDRO-BRUSH



ON / OFF

SSA1536

Set completo idroscopino WC in acciaio INOX 316L, idroscopino con flessibile 120cm, attacco G1"1/2.
Stainless steel 316L complete WC set, hydro-brush with cm 120 flexible hose, G1"1/2 connection.



SSA1516DC

Doccetta idroscopino per pulizia in acciaio INOX 316L.
Hydro-brush wc cleaning handspray, stainless steel 316L.

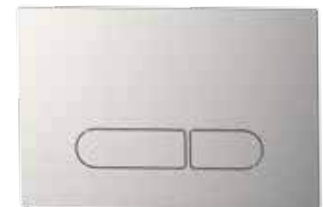

SSA2830GE

Placca di comando in acciaio inox spazzolato per cassetta di scarico WC da incasso, adatta per Geberit Sigma8/12.
Brushed stainless steel flush plate for concealed cistern, suitable for Geberit Sigma8/12.



COMPLEMENTI - COMPLEMENTS



SSA735R

Scarico automatico universale in acciaio INOX con chiusura click-clack da 1"1/4.
Stainless steel universal automatic pop-up waste, 1"1/4, with click-clack system.

INOX

PVD



SSA750114

Sifone "minimal" in acciaio INOX per lavabo, 1"1/4, canotto cm 30 e rosone pesante.
Stainless steel "minimal" p trap for wash-basin, 1"1/4, outlet tube cm 30 and heavy flange.

INOX

PVD



Flessibile per doccia retinato metallizzato in pvc atossico, con attacco doppio brillante conico, colore acciaio.
Flexible hose for shower with metal colour net, in atoxic pvc, with double conical shiny brilliant nut, steel color.

SSA516120

Lunghezza 120 cm.
Lenght 120 cm.

INOX

PVD

SSA516150

Lunghezza 150 cm.
Lenght 150 cm.

INOX

PVD

COLONNE DOCCIA - SHOWER COLUMN



SSTXT6367825



Set colonna doccia termostatica in acciaio inox spazzolato, include: miscelatore esterno doccia termostatico, colonna, doccetta a 1 funzione e soffione Ø 25 mm, flessibile 150cm.
Thermostatic shower column set in brushed stainless steel, including: external thermostatic mixer, column, 1-function hand shower and Ø 25 mm shower head, 150cm hose.

INOX

PVD



SSTX6367825

Set colonna doccia in acciaio inox spazzolato, include: miscelatore esterno doccia, colonna, doccetta a 1 funzione e soffione Ø 25 mm, flessibile 150cm.
Shower column set in brushed stainless steel, including: external shower mixer, column, 1-function hand shower and Ø 25 mm shower head, 150cm hose.

INOX

PVD

— KIT WELLNESS - WELLNESS KIT —



Set doccia a incasso, composto da: miscelatore a incasso in acciaio inox con deviatore a 2 vie su due piastre TOKYO STEEL, asta saliscendi in acciaio inox spazzolato, presa acqua a muro in acciaio inox, braccio a muro in acciaio inox spazzolato 30cm, soffione ultra piatto in acciaio INOX spazzolato, doccetta a 1 funzione in acciaio inox, flessibile in pvc color acciaio 150cm.

Built-in shower set, including: built-in mixer in stainless steel with 2-way diverter on two plates TOKYO STEEL, brushed stainless steel sliding rail, brushed stainless steel wall water connection, brushed stainless steel 30cm wall arm, ultra-flat shower head in brushed stainless steel, brushed stainless steel 1-function hand shower, 150cm steel-colour pvc flexible hose.

SSTX614ZD2P7820

Soffione Ø20cm, braccio a parete da 30cm.
Head shower Ø20cm and wall arm 30cm.

INOX PVD

SSTX614ZD2P7825

Soffione Ø25cm, braccio a parete da 30cm.
Head shower Ø25cm and wall arm 30cm.

INOX PVD

SSTX614ZD2P7830

Soffione Ø30cm, braccio a parete da 30cm.
Head shower Ø30cm and wall arm 30cm.

INOX PVD

SSTX614SD2P7820

Soffione Ø20cm, braccio a soffitto da 30cm.
Head shower Ø20cm and ceiling arm 30cm.

INOX PVD



Set doccia a incasso, composto da: miscelatore a incasso in acciaio inox con deviatore a 2 vie su due piastre TOKYO STEEL, presa acqua a muro in acciaio inox con supporto per doccetta, braccio a muro in acciaio inox spazzolato 30cm, soffione ultra piatto in acciaio INOX spazzolato, doccetta a 1 funzione in acciaio inox, flessibile in pvc color acciaio 150cm.

Built-in shower set, including: built-in mixer in stainless steel with 2-way diverter on two plates TOKYO STEEL, brushed stainless steel wall water connection with shower holder, brushed stainless steel 30cm wall arm, ultra-flat shower head in brushed stainless steel, brushed stainless steel 1-function hand shower, 150cm steel-colour pvc flexible hose.

SSTX615ZD2P7820

Soffione Ø20cm, braccio a parete da 30cm.
Head shower Ø20cm and wall arm 30cm.

INOX PVD

SSTX615ZD2P7825

Soffione Ø25cm, braccio a parete da 30cm.
Head shower Ø25cm and wall arm 30cm.

INOX PVD

SSTX615ZD2P7830

Soffione Ø30cm, braccio a parete da 30cm.
Head shower Ø30cm and wall arm 30cm.

INOX PVD

SSTX615SD2P7820

Soffione Ø20cm, braccio a soffitto da 30cm.
Head shower Ø20cm and ceiling arm 30cm.

INOX PVD



Set doccia a incasso, composto da: miscelatore a incasso in acciaio inox con deviatore a 3 vie su due piastre TOKYO STEEL, asta saliscendi in acciaio inox spazzolato, presa acqua a muro in acciaio inox, braccio a muro in acciaio inox spazzolato 30cm, soffione ultra piatto in acciaio INOX spazzolato, doccetta a 1 funzione in acciaio inox, 6 getti a incasso in acciaio inox spazzolato, flessibile in pvc color acciaio 150cm.

Built-in shower set, including: built-in mixer in stainless steel with 3-way diverter on two plates TOKYO STEEL, brushed stainless steel sliding rail, brushed stainless steel wall water connection, brushed stainless steel 30cm wall arm, ultra-flat shower head in brushed stainless steel, brushed stainless steel 1-function hand shower, 6 built-in jets in brushed stainless steel, 150cm steel-colour pvc flexible hose.

SSTX613ZP7820

Soffione Ø20cm, braccio a parete da 30cm.
Head shower Ø20cm and wall arm 30cm.

INOX PVD

SSTX613ZP7825

Soffione Ø25cm, braccio a parete da 30cm.
Head shower Ø25cm and wall arm 30cm.

INOX PVD

SSTX613ZP7830

Soffione Ø30cm, braccio a parete da 30cm.
Head shower Ø30cm and wall arm 30cm.

INOX PVD

SSTX613SP7820

Soffione Ø20cm, braccio a soffitto da 30cm.
Head shower Ø20cm and ceiling arm 30cm.

INOX PVD



Set doccia a incasso, composto da: miscelatore a incasso in acciaio inox con deviatore a 3 vie su due piastre TOKYO STEEL, presa acqua a muro in acciaio inox con supporto per doccetta, braccio a muro in acciaio inox spazzolato 30cm, soffione ultra piatto in acciaio INOX spazzolato, doccetta a 1 funzione in acciaio inox, 6 getti a incasso in acciaio inox spazzolato, flessibile in pvc color acciaio 150cm.

Built-in shower set, including: built-in mixer in stainless steel with 3-way diverter on two plates TOKYO STEEL, brushed stainless steel wall water connection with shower holder, brushed stainless steel 30cm wall arm, ultra-flat shower head in brushed stainless steel, brushed stainless steel 1-function hand shower, 6 built-in jets in brushed stainless steel, 150cm steel-colour pvc flexible hose.

SSTX616ZP7820

Soffione Ø20cm, braccio a parete da 30cm.
Head shower Ø20cm and wall arm 30cm.

INOX PVD

SSTX616ZP7825

Soffione Ø25cm, braccio a parete da 30cm.
Head shower Ø25cm and wall arm 30cm.

INOX PVD

SSTX616ZP7830

Soffione Ø30cm, braccio a parete da 30cm.
Head shower Ø30cm and wall arm 30cm.

INOX PVD

SSTX616SP7820

Soffione Ø20cm, braccio a soffitto da 30cm.
Head shower Ø20cm and ceiling arm 30cm.

INOX PVD



SSTX614ZPSSCA

Set doccia a incasso, composto da: miscelatore a incasso in acciaio inox con deviatore a 3 vie su due piastre TOKYO STEEL, asta saliscendi in acciaio inox spazzolato, presa acqua a muro in acciaio inox, soffione a parete in acciaio inox spazzolato con getto pioggia e cascata, doccetta a 1 funzione in acciaio inox, flessibile in pvc color acciaio 150cm.
Built-in shower set, including: built-in mixer in stainless steel with 3-way diverter on two plates TOKYO STEEL, brushed stainless steel sliding rail, brushed stainless steel wall water connection, wall-mounted shower head in brushed stainless steel with rain and waterfall jets, brushed stainless steel 1-function hand shower, 150cm steel-colour pvc flexible hose.

INOX PVD



SSTX615ZPSSCA

Set doccia a incasso, composto da: miscelatore a incasso in acciaio inox con deviatore a 3 vie su due piastre TOKYO STEEL, presa acqua a muro in acciaio inox con supporto per doccetta, soffione a parete in acciaio inox spazzolato con getto pioggia e cascata, doccetta a 1 funzione in acciaio inox, flessibile in pvc color acciaio 150cm.
Built-in shower set, including: built-in mixer in stainless steel with 3-way diverter on two plates TOKYO STEEL, brushed stainless steel wall water connection with shower holder, wall-mounted shower head in brushed stainless steel with rain and waterfall jets, brushed stainless steel 1-function hand shower, 150cm steel-colour pvc flexible hose.

INOX PVD

— KIT SENZA MISCELATORE - KIT WITHOUT SHOWER MIXER —



Set doccia composto da: soffione tondo in acciaio inox, braccio in acciaio inox 30 cm, presa acqua a muro con supporto doccetta, doccetta minimale in acciaio inox, a 1 funzione, flessibile in PVC 150 cm. Set da completare con un miscelatore a incasso con deviatore (NON incluso).
Shower set including: stainless steel round shower head, stainless steel arm 30 cm, wall water connection with shower holder, 1-function stainless steel hand shower, 150 cm PVC flexible hose. Set to be completed with a built-in mixer with diverter (not included).

SSSD615Z4357820

Soffione Ø20cm, braccio da 30cm.
 Head shower Ø20cm and arm 30cm.

INOX PVD

SSSD615Z4357825

Soffione Ø25cm, braccio da 30cm.
 Head shower Ø25cm and arm 30cm.

INOX PVD

SSSD615Z4357830

Soffione Ø30cm, braccio da 30cm.
 Head shower Ø30cm and arm 30cm.

INOX PVD



Set doccia composto da: soffione quadrato in acciaio inox, braccio in acciaio inox 30 cm, presa acqua a muro con supporto doccetta, doccetta piatta in acciaio inox a 1 funzione, flessibile in PVC 150 cm. Set da completare con un miscelatore a incasso con deviatore (NON incluso).
Shower set including: stainless steel squared shower head, stainless steel arm 30 cm, wall water connection with shower holder, 1-function stainless steel flat hand shower, 150 cm PVC flexible hose. Set to be completed with a built-in mixer with diverter (not included).

SSSD615Z4947920

Soffione 20x20cm, braccio da 30cm.
 Head shower 20x20cm and arm 30cm.

INOX PVD

SSSD615Z4947925

Soffione 25x25cm, braccio da 30cm.
 Head shower 25x25cm and arm 30cm.

INOX PVD

SSSD615Z4947930

Soffione 30x30cm, braccio da 30cm.
 Head shower 30x30cm and arm 30cm.

INOX PVD

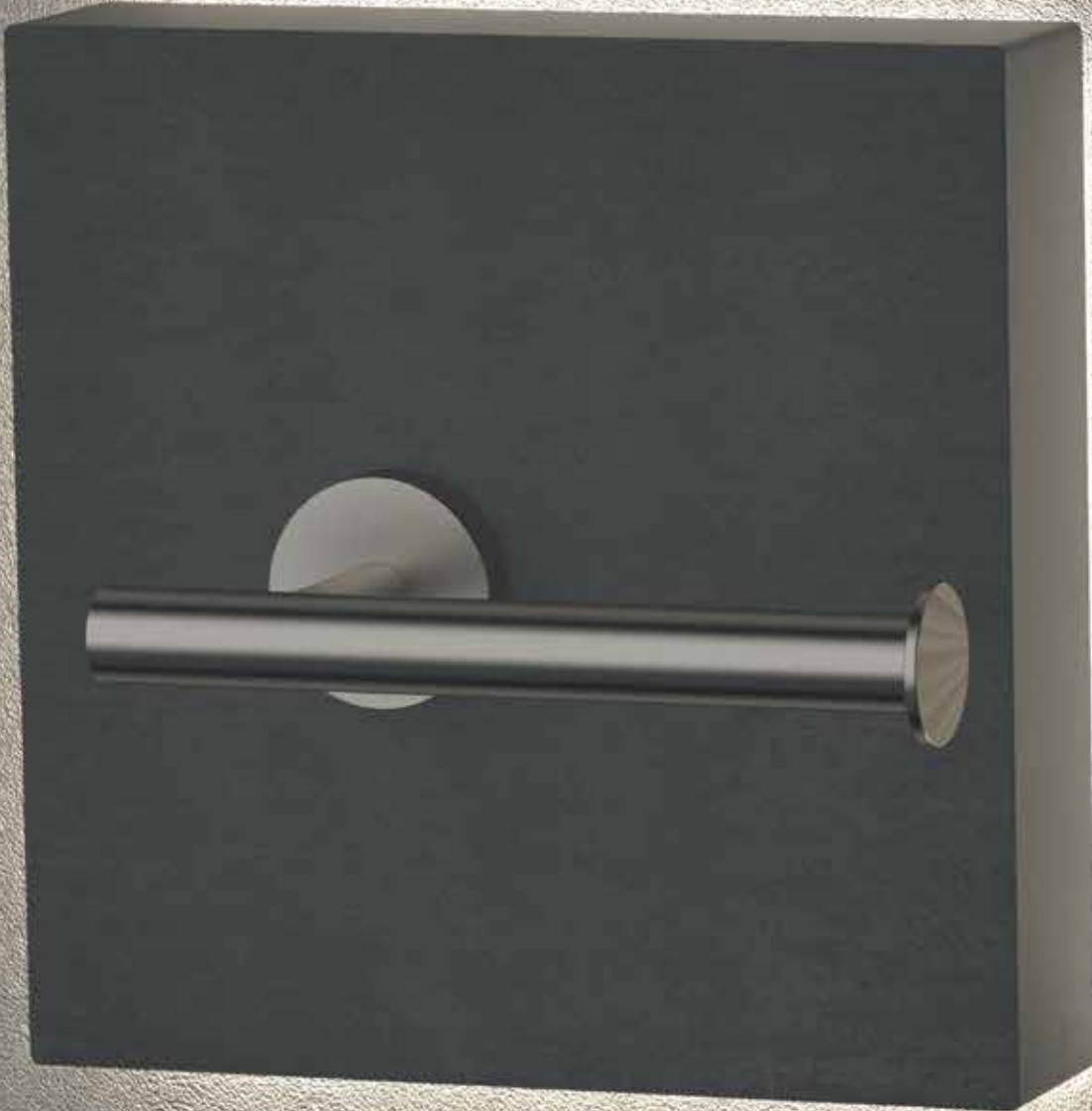

ACCESSORIES STEEL



ACCESSORIES STEEL

ACCESSORI - ACCESSORIES



SSTXDIA954

Dispenser in acciaio INOX spazzolato.
Brushed stainless steel dispenser.

INOX
 PVD



SSTXDI954

Dispenser per sapone liquido da parete con supporto tutto in acciaio INOX spazzolato.
Wall mounted soap dispenser with support all in brushed stainless steel.

INOX
 PVD



SSTXPBA940

Bicchieri in acciaio INOX spazzolato.
Brushed stainless steel cup.

INOX
 PVD



SSTXPB940

Portabicchiere da parete con bicchiere in acciaio INOX spazzolato.
Wall mounted cup holder with glass all in brushed stainless steel.

INOX
 PVD



SSTXPR911

Portarotolo in acciaio INOX spazzolato.
Brushed stainless steel toilet paper holder.

INOX
 PVD



SSTXPRR920

Portarotolo di ricambio in acciaio INOX spazzolato.
Brushed stainless steel spare toilet paper holder.

INOX
 PVD



SSTXPSA930

Portascopino in acciaio INOX spazzolato da pavimento.

Brushed stainless steel floor broom rack holder.

INOX

PVD



SSTXPS930

Portascopino in acciaio INOX da parete spazzolato.

Wall brushed stainless steel broom rack holder.

INOX

PVD



SSTXAP960

Portarotolo di ricambio in acciaio INOX spazzolato.

Brushed stainless steel spare toilet paper holder.

INOX

PVD

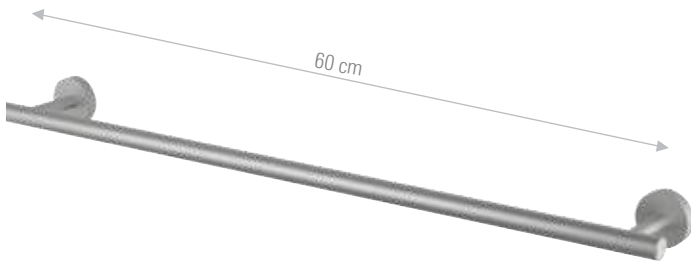

60 cm

SSTXPS975

Portasalviette in acciaio INOX spazzolato.

Brushed stainless steel towel holder.

INOX

PVD

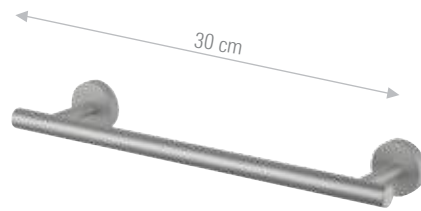

30 cm

SSTXPS973CM30

Portasalviette in acciaio INOX spazzolato.

Brushed stainless steel towel holder.

INOX

PVD





KITCHEN STEEL

KITCHEN STEEL



SSTX618

Miscelatore monocomando per lavello, con bocca girevole, areatore anticalcare M22x1, acciaio inox spazzolato 316L.

Single-lever sink mixer, with swivel spout, M22x1 anti-limescale aerator, brushed stainless steel 316L.



SSTX618U

Miscelatore monocomando per lavello in acciaio inox 316L spazzolato, canna quadra "U" girevole.

Single-lever sink mixer in brushed 316L stainless steel, square "U" swivel spout.



SSTX684DJ

Miscelatore monocomando per lavello in acciaio inox 316L, con doccetta estraibile a due getti, anticalcare.

Single-lever sink mixer in 316L stainless steel, with two-jet pull-out hand shower, anti-limescale.



SSTX241

Miscelatore monocomando per lavello in acciaio inox 316L, bocca girevole con flessibile rivestito in gomma soft-touch nero opaco, doccetta a 2 getti anticalcare. La doccetta può essere sganciata dal supporto ed orientata.

Single-lever sink mixer in 316L stainless steel, swivel spout with flexible hose covered in matt black soft-touch rubber, 2-jet anti-limescale hand shower. Hand shower can be detached from its holder and oriented.



SSTX243

Miscelatore monocomando per lavello in acciaio inox 316L, bocca girevole con flessibile rivestito a molla, doccetta a 2 getti anticalcare. La doccetta può essere sganciata dal supporto ed orientata.

Single-lever sink mixer in 316L stainless steel, swivel spout with spring-coated flexible hose, 2-jet anti-limescale hand shower. Hand shower can be detached from its holder and oriented.





SSTX618

KITCHEN STEEL ACCESSORIES STEEL WELLNESS STEEL TOKYO STEEL



CONTEMPORARY



SR606

REFLEX pag 222

OMEGA pag 238

SMART pag 254

OMEGA GREEN pag 272

SMART GREEN pag 280

REFLEX

Reflex è una collezione di rubinetteria monocomando moderna e originale. Le superfici sfaccettate riflettono la luce circostante come fanno le pietre preziose e rendono Reflex un dettaglio di pregio in ogni stile di arredo.

Reflex is a faucet collection of modern and original single-lever mixers. The faceted surfaces reflect the surrounding light like precious stones do and make Reflex a valuable detail in any style of furniture.

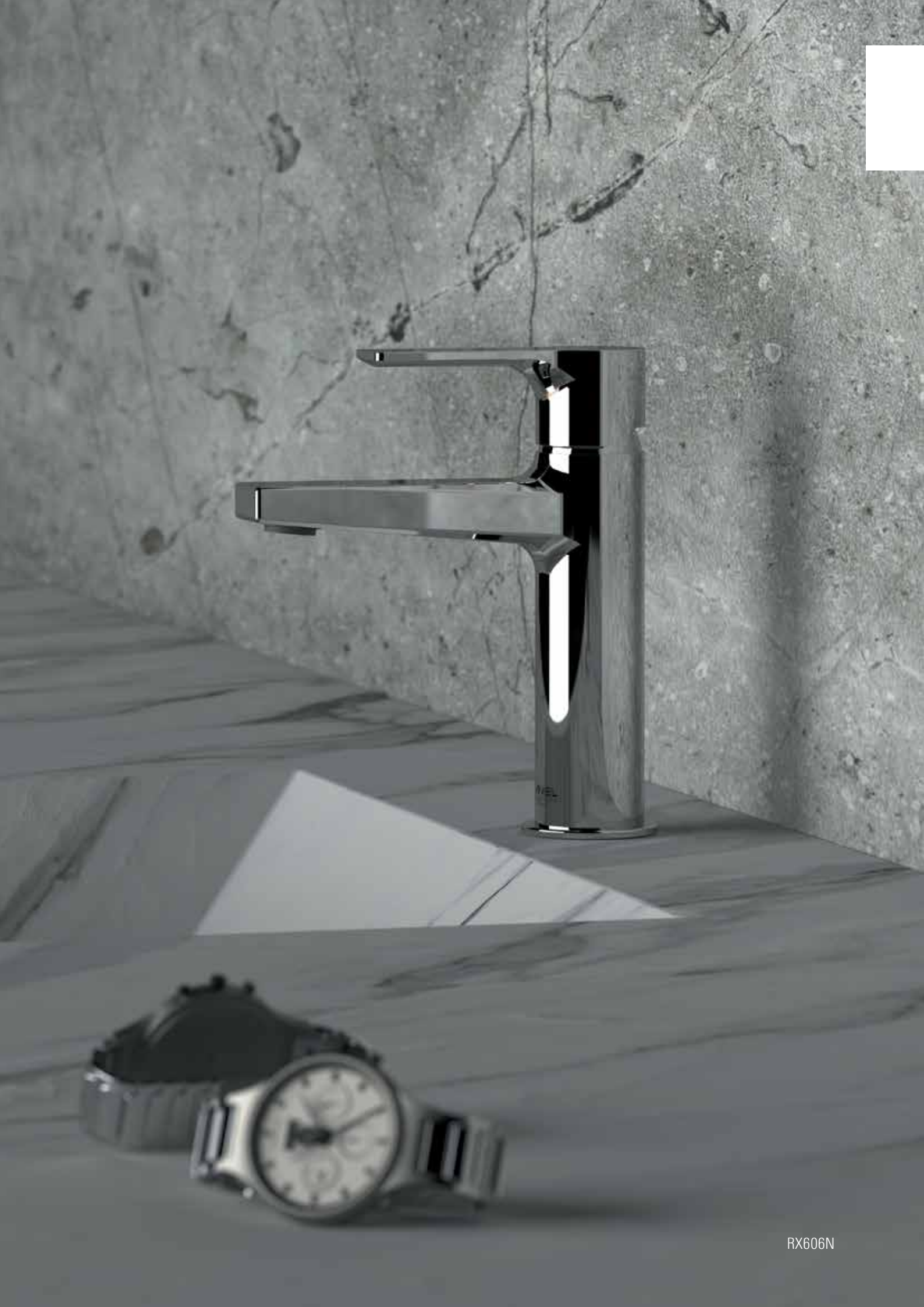

RX606N

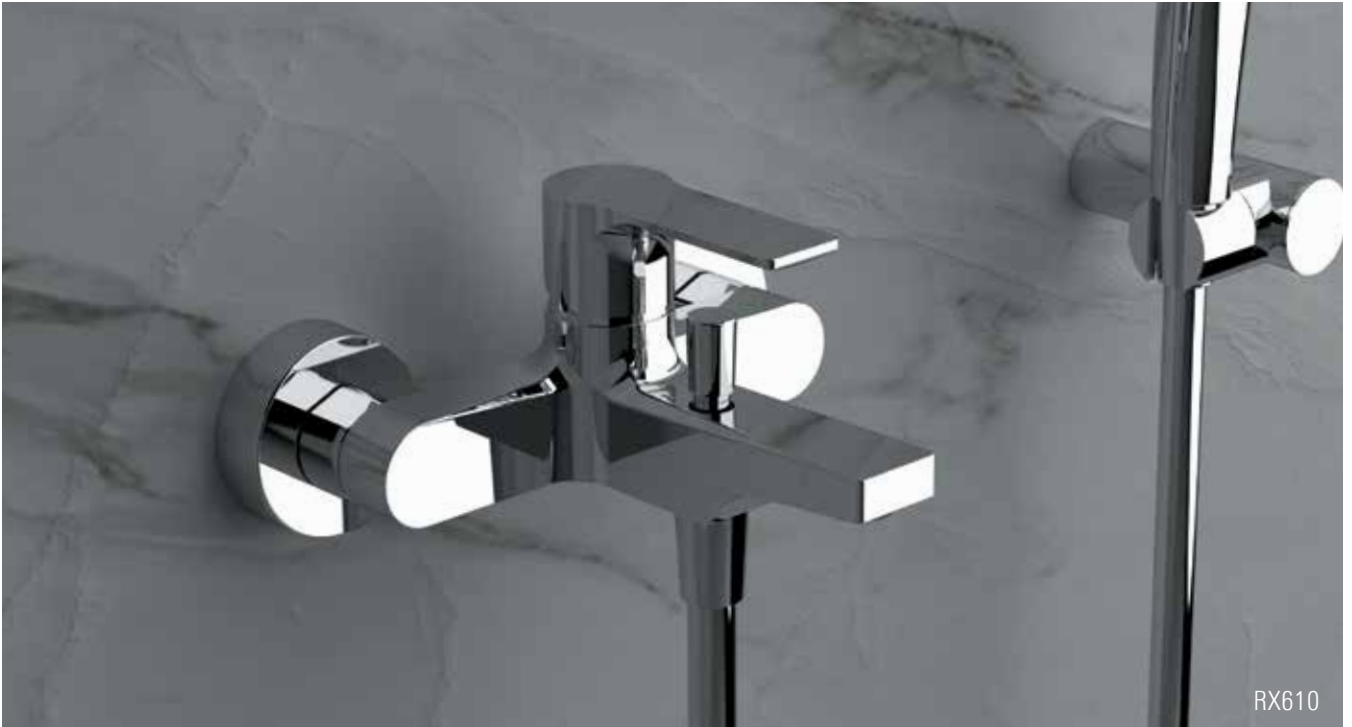

RX610



RX606N

CARATTERISTICHE TECNICHE:

La serie è dotata di cartuccia a dischi ceramici, Ø 35 mm, prodotta da S.T.S.R. – Studio Tecnico Sviluppo e Ricerche - www.stsr.it

TECHNICAL FEATURES:

The series is equipped with ceramic cartridge, Ø 35 mm, produced by S.T.S.R. - Research Development Technical Office - www.stsr.it



RX606N



15
NERO OPACO
MATT BLACK

RX60715

REFLEX

OMEGA

SMART

OMEGA GREEN

SMART GREEN

LAVABI - WASHBASIN MIXERS



RX605

Monocomando lavabo, con scarico.
Single-lever basin mixer, with pop-up waste.

CR FIN A FIN B



RX606N

Monocomando lavabo, senza scarico e senza foro sul corpo.
Single-lever basin mixer, without waste and without body hole.

CR FIN A FIN B



RX607

Miscelatore monocomando lavabo alto L, con scarico click-clack con troppopieno.
Single-lever high L basin mixer, with click-clack waste and overflow.

CR FIN A FIN B



RX632

Miscelatore monocomando a incasso per lavabo, con piastra orizzontale in ottone.
Lunghezza bocca: 18,5 cm.
Single-lever built-in basin mixer, with wall flange in brass. Spout length: 18,5 cm.

CR FIN A FIN B



RX632P

Miscelatore monocomando da incasso per lavabo, su doppia piastra.
Lunghezza bocca: 18,5 cm.
Built-in single-lever basin mixer with two separate plates. Spout length: 18,5 cm.

CR FIN A FIN B



RX607B

Miscelatore monocomando lavabo alto L, senza scarico.
Single-lever high L basin mixer, without waste.

CR FIN A FIN B



RX632L

Miscelatore monocomando a incasso per lavabo, con piastra orizzontale in ottone.
Lunghezza bocca: 23 cm.
Single-lever built-in basin mixer, with wall flange in brass. Spout length: 23 cm.

CR FIN A FIN B

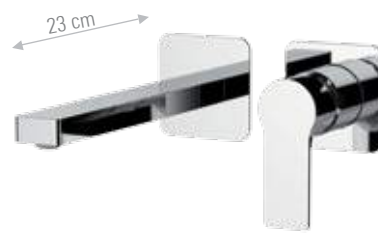

RX632PL

Miscelatore monocomando da incasso per lavabo, su doppia piastra.
Lunghezza bocca: 23 cm.
Built-in single-lever basin mixer with two separate plates. Spout length: 23 cm.

CR FIN A FIN B



RX655

Miscelatore monocomando a due fori per lavabo. Scarico non incluso.
Two-hole single-lever washbasin mixer. Waste not included.

CR FIN A FIN B

BOCCHIE - SPOUT

LAVABO BOX INCASSO
BUILT-IN BOX WASHBASIN MIXER

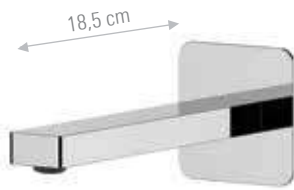

RX4704

Bocca a incasso. Lunghezza bocca: 18,5 cm.
Built-in spout. Spout length: 18,5 cm

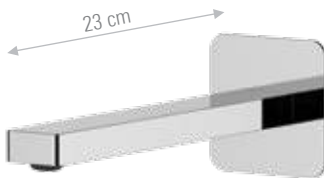

RX4704L

Bocca a incasso. Lunghezza bocca: 23 cm.
Built-in spout. Spout length: 23 cm



RX632KB

Miscelatore monocomando a incasso per lavabo, con piastra in ottone, bocca lunghezza 18 cm, da abbinare al box incasso.
Single-lever built-in basin mixer, with wall flange in brass, spout length 18 cm, to use with the built-in box.



RX632LKB

Miscelatore monocomando a incasso per lavabo, con piastra in ottone, bocca lunghezza 23 cm, da abbinare al box incasso.
Single-lever built-in basin mixer, with wall flange in brass, spout length 23 cm, to use with the built-in box.



DANBOX632

Box incasso per miscelatore monocomando a incasso per lavabo.
Built-in box for single-lever built-in basin mixer.

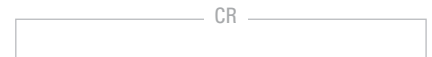

BIDET



RX655L

Miscelatore monocomando a due fori per lavabo. Scarico non incluso.
Two-hole single-lever washbasin mixer. Waste not included.



RX604

Miscelatore monocomando bidet, con scarico.
Single-lever bidet mixer, with pop-up waste.



RX604BN

Miscelatore monocomando bidet, senza scarico e senza foro sul corpo.
Single-lever bidet mixer, without waste and without body hole.



RX645BP4DC

Miscelatore incasso per shut-off con supporto doccia/presa acqua integrato, attacco conico da 1/2", con doccetta shut-off e flessibile cm 120.
Built-in shower mixer with integrated shower holder/water punch on flange, with 1/2 connection, with shut-off and flexible hose cm 120.



MISCELATORI VASCA E DOCCIA - SHOWER AND BATH MIXERS



RX226114DC

Miscelatore monocomando esterno doccia, interasse 100 mm, con doccetta shut-off e flessibile cm 120.
Wall mounted single lever shower mixer, interaxis 100 mm, including shut-off and flexible hose cm 120.

CR FIN A FIN B

RX22611

Miscelatore monocomando esterno doccia, interasse 100 mm, senza kit doccia.
Wall mounted single lever shower mixer, interaxis 100 mm, without shower kit.

CR FIN A FIN B



RX610

Miscelatore vasca con deviatore integrato, con flessibile cm 150 e doccetta a 4 funzioni con pulsante cambio getti, anticalcare e supporto snodato.
Wall mounted bath mixer with integrated diverter, with flexible hose cm 150 and 4 functions antilimestone handshower with button to change jets and movable shower holder.

CR FIN A FIN B

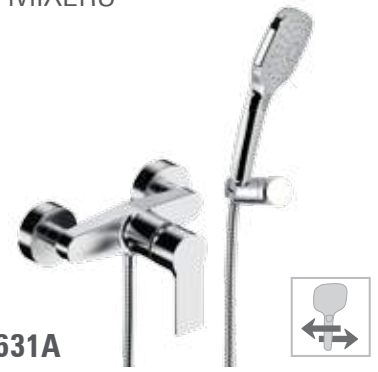

RX631A

Miscelatore doccia con leva frontale, con flessibile cm 150 e doccetta a 4 funzioni con pulsante cambio getti, anticalcare con supporto snodato.
Exposed shower mixer with frontal lever, with flexible cm 150 and 4 functions with button to change jets, antilimestone handshower with silicon jets and movable shower holder.

CR FIN A FIN B

RX600H

Miscelatore vasca con deviatore integrato, senza kit doccia.
Wall mounted bath mixer with integrated diverter, without shower kit.

CR FIN A FIN B

RX631

Miscelatore doccia con leva frontale, senza kit doccia.
Exposed shower mixer with frontal lever, without shower kit.

CR FIN A FIN B

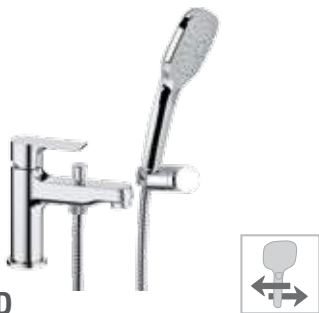

RX606D

Miscelatore monocomando per vasca, con deviatore, flessibile cm 150 e doccetta a 4 funzioni con pulsante cambio getti, getti in silicone anticalcare e supporto snodato.
Single lever bath mixer with diverter, with diverter, flexible cm 150 and 4 functions antilimestone handshower with button to change jets, silicon jets and movable shower holder.

CR FIN A FIN B



RX606DH

Miscelatore monocomando per vasca, con deviatore, senza kit doccia.
Single lever bath mixer with diverter, without shower kit.

CR FIN A FIN B

DOCCETTA IN FINITURA
 FINISH HAND SHOWER

Il modello della doccetta inclusa nel kit può variare in base alla finitura scelta.
The model of the hand shower included in the kit may vary according to the chosen finish.

CR	FIN A	FIN B
		
Doccetta abs, 4 funzioni. <i>ABS hand shower, 4-function.</i>		Doccetta quadrata in ottone, 1 funzione. <i>Square brass hand shower, 1-function.</i>

□ □ □ 2 VIE - 2-WAY □ □ □

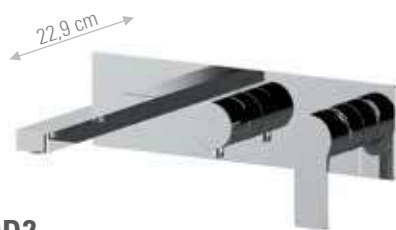
**RX700D2**

Set miscelatore a incasso a 2 vie per vasca/doccia su piastra unica rettangolare, include miscelatore monocomando, deviatore a 2 uscite, bocca a muro. Da completare con una seconda uscita acqua.

2-way built-in mixer set for bathtub / shower on single rectangular plate, including single-lever mixer, 2-way diverter, wall spout.

To be completed with a second water outlet.

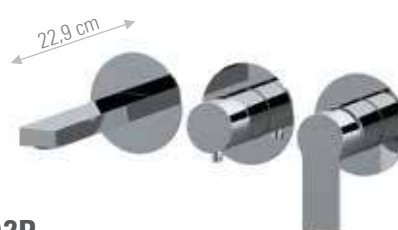
**RX700D2P**

Set miscelatore a incasso a 2 vie per vasca/doccia su 3 piastre tonde separate (piastre separate e incasso unico), include: miscelatore monocomando, deviatore a 2 uscite, bocca a muro.

Da completare con una seconda uscita.

2-way built-in mixer set for bathtub / shower on 3 separate round plates (separate plates, one single built-in part), including: single-lever mixer, 2-way diverter, wall spout. To be completed with a second water outlet.

**RX710D2**

Set a incasso a 2 vie per vasca, include: miscelatore monocomando, deviatore a 2 uscite e bocca a muro su piastra unica rettangolare; set doccia su piastra quadrata con presa acqua, supporto integrato, doccetta in ottone e flessibile 150cm.

2-way built-in set for bathtub, including: single-lever mixer, 2-way diverter and wall spout on a single rectangular plate; shower set on square plate with water connection, holder, brass handshower and 150cm flexible hose.

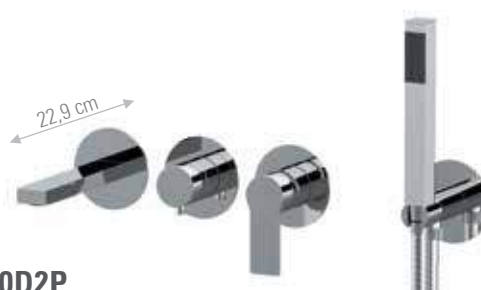
**RX710D2P**

Set a incasso a 2 vie per vasca su piastre tonde separate (3 piastre separate e incasso unico), include: miscelatore monocomando con deviatore a 2 uscite, bocca a muro; set doccia su piastra tonda con presa acqua, supporto, doccetta e flessibile 150cm.

2-way built-in set for bathtub on separate round plates (3 separate plates, one single built-in part), including: single-lever mixer, 2-way diverter, wall spout; Shower set on round plate with water connection, holder, hand shower and 150cm flexible hose.

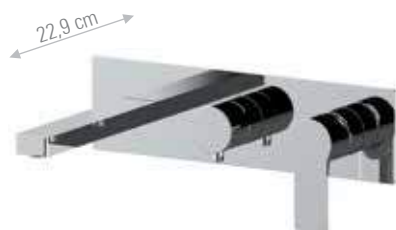

□ □ □ 3 VIE - 3-WAY □ □ □

**RX700D3**

Set miscelatore a incasso a 3 vie per vasca/doccia su piastra unica rettangolare, include miscelatore monocomando, deviatore a 3 uscite, bocca a muro. Da completare con una seconda e una terza uscita acqua.

3-way built-in mixer set for bathtub/shower on single rectangular plate, including single-lever mixer, 3-way diverter, wall spout.

To be completed with second and third water outlets.

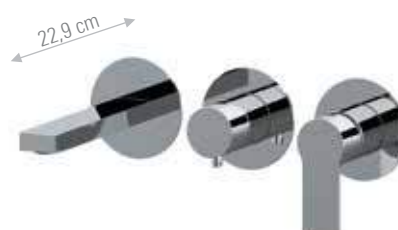
**RX700D3P**

Set miscelatore a incasso a 3 vie per vasca/doccia su 3 piastre tonde separate (piastre separate e parte a incasso unica), composto da: miscelatore monocomando con deviatore a 3 uscite, bocca a muro.

Da completare con una seconda e una terza uscita acqua.

3-way built-in mixer set for bathtub/shower on 3 separate round plates (separate plates, one single built-in part), including: single-lever mixer with 3-way diverter, wall spout. To be completed with second and third water outlets.



INCASSI DOCCIA - BUILT-IN MIXERS

□ □ □ 1 VIA - 1-WAY □ □ □



RX602G

Miscelatore incasso per doccia (articolo COMPLETO).
Built-in shower mixer (COMPLETE item).

CR FIN A FIN B

IN602C35

SOLO parti a incasso
Built-in parts ONLY.

CR FIN A FIN B

RX602GEKIT

SOLO parti esterne.
Exposed parts ONLY.

CR FIN A FIN B



RX602

Miscelatore incasso per doccia su piastra tonda (articolo COMPLETO).
Built-in shower mixer on round plate (COMPLETE item).

CR FIN A FIN B

IN602C35

SOLO parti a incasso
Built-in parts ONLY.

CR FIN A FIN B

RX602EKIT

SOLO parti esterne.
Exposed parts ONLY.

CR FIN A FIN B



RX602B

Miscelatore incasso per doccia su piastra lusso ultrapiatta (articolo COMPLETO).
Built-in shower mixer on luxury ultraslim plate (COMPLETE item).

CR FIN A FIN B

IN602C35

SOLO parti a incasso
Built-in parts ONLY.

CR FIN A FIN B

RX602BEKIT

SOLO parti esterne.
Exposed parts ONLY.

CR FIN A FIN B

□ □ □ 2 VIE - 2-WAY □ □ □



RX612G

Miscelatore incasso con deviatore per vasca/doccia (articolo COMPLETO).
Built-in bath/shower mixer with diverter (COMPLETE item).

CR FIN A FIN B

--	--	--

IN612C35

SOLO parti a incasso
Built-in parts ONLY.

CR FIN A FIN B

--	--	--

RX612GEKIT

SOLO parti esterne.
Exposed parts ONLY.

CR FIN A FIN B

--	--	--



RX612

Miscelatore incasso con deviatore per vasca/doccia su piastra tonda (articolo COMPLETO).
Built-in bath/shower mixer with diverter on round plate (COMPLETE item).

CR FIN A FIN B

--	--	--

IN612C35

SOLO parti a incasso
Built-in parts ONLY.

CR FIN A FIN B

--	--	--

RX612EKIT

SOLO parti esterne.
Exposed parts ONLY.

CR FIN A FIN B

--	--	--



RX612B

Miscelatore incasso con deviatore per vasca/doccia su piastra lusso ultrapiatta (articolo COMPLETO).
Built-in bath/shower mixer with diverter on luxury ultraslim plate (COMPLETE item).

CR FIN A FIN B

--	--	--

IN612C35

SOLO parti a incasso
Built-in parts ONLY.

CR FIN A FIN B

--	--	--

RX612BEKIT

SOLO parti esterne.
Exposed parts ONLY.

CR FIN A FIN B

--	--	--

CONTEMPORARY



RX612D2

Miscelatore incasso con deviatore a 2 vie per vasca/doccia su piastra lusso ultrapiatta (articolo COMPLETO).
Built-in bath/shower mixer with 2-way diverter on luxury ultraslim plate (COMPLETE item).

CR FIN A FIN B



RX712D2

Set miscelatore a incasso a 2 vie per doccia su piastra unica rettangolare, include presa acqua con supporto, doccetta e flessibile 150 cm. Da completare con una 2° uscita.
2-way built-in shower mixer set on a single rectangular plate, including water connection with shower holder, hand shower and 150cm hose. To be completed with a 2nd water outlet.

CR FIN A FIN B



RX712D2P

Set miscelatore a incasso a 2 vie per doccia su 3 piastre tonde separate (parte a incasso unica), include: miscelatore e deviatore a 2 uscite, presa acqua con supporto, doccetta in ottone e flessibile 150 cm. Da completare con una 2° uscita.
2-way built-in shower mixer set on 3 separate round plates (single built-in part), including: mixer and 2-way diverter, water connection with holder, brass hand shower and 150cm flexible hose. To be completed with a 2nd water outlet.

CR FIN A FIN B

□ □ □ 3 VIE - 3-WAY □ □ □



RX612D3

Miscelatore incasso con deviatore a 3 vie per vasca/doccia, 1 entrata e 3 uscite (articolo COMPLETO).
Built-in bath/shower mixer with 3-way diverter, 1 inlet and 3 outlets (COMPLETE item).

CR FIN A FIN B



RX712D3

Set miscelatore a incasso a 3 vie per doccia su piastra unica rettangolare, include: miscelatore, deviatore a 3 uscite, presa acqua con supporto, doccetta in ottone e flessibile 150 cm. Da completare con una seconda e una terza uscita acqua. Da completare con una 2° ed una 3° uscita.
3-way built-in shower mixer set on a single rectangular plate, including: single-lever mixer, 3-way diverter, water connection with shower holder, brass hand shower and 150cm flexible hose. To be completed with a 2nd and 3rd water outlet.

CR FIN A FIN B



RX712D3P

Set miscelatore a incasso a 3 vie per doccia su 3 piastre tonde separate (parte a incasso unica), include: miscelatore e deviatore a 3 uscite, presa acqua con supporto, doccetta in ottone e flessibile 150cm. Da completare con una 2° ed una 3° uscita.
3-way built-in shower mixer set on 3 separate round plates (single built-in part), including: mixer and 3-way diverter, water connection with holder, brass hand-shower and 150cm flexible hose. To be completed with a 2nd and 3rd water outlet.

CR FIN A FIN B

□ □ □ 4/5 VIE - 4/5-WAY □ □ □



RX612D4

Miscelatore incasso con deviatore a 4 vie per vasca/doccia, 1 entrata e 4 uscite (articolo COMPLETO).
Built-in bath/shower mixer with 4-way diverter, 1 inlet and 4 outlets (COMPLETE item).

CR FIN A FIN B



RX612D5

Miscelatore incasso con deviatore a 5 vie per vasca/doccia, 1 entrata e 5 uscite (articolo COMPLETO).
Built-in bath/shower mixer with 5-way diverter, 1 inlet and 5 outlets (COMPLETE item).

CR FIN A FIN B

COLONNE DOCCIA - SHOWER COLUMN



RX636DA3MPEC20

Set colonna vasca/doccia a 3 vie, composto da: miscelatore esterno vasca/doccia per colonna con deviatore REFLEX, colonna telescopica ad altezza regolabile, soffione Ø 20 cm in abs cromato, doccetta in ABS a 4 funzioni con pulsante per il cambio dell'intensità, flessibile 150cm.
3-way bath/shower column set, including: exposed bath/shower mixer for column with diverter REFLEX, height-adjustable telescopic column, Ø 20cm abs shower head, 4-function abs hand shower with button for switching jet modes, 150cm flexible hose.

CR

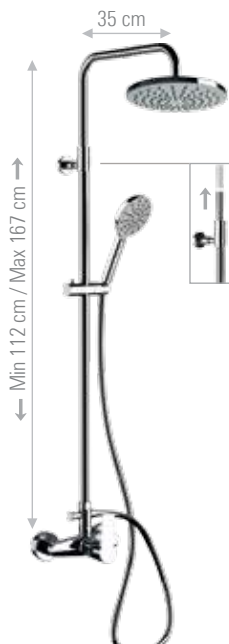

RX636A3MPEC20

Set colonna doccia, composto da: miscelatore esterno per colonna REFLEX, colonna telescopica ad altezza regolabile con deviatore, flessibile doccia 150cm, soffione Ø 20 cm in abs cromato, doccetta in ABS a 4 funzioni con pulsante per il cambio dell'intensità,
Shower column set, including: exposed mixer for column REFLEX, height-adjustable telescopic column with diverter, 150cm flexible hose, Ø 20cm abs shower head, 4-function abs hand shower with button for switching jet modes.

CR



Set colonna vasca/doccia a 3 vie, composto da: miscelatore esterno vasca/doccia per colonna con deviatore REFLEX, colonna telescopica ad altezza regolabile, soffione in abs, doccetta in ABS a 3 funzioni con pulsante per il cambio dell'intensità, flessibile 150cm.
3-way bath/shower column set, including: exposed bath/shower mixer for column with diverter REFLEX, height-adjustable telescopic column, abs shower head, 3-function abs hand shower with button for switching jet modes, 150cm flexible hose.

RX636DA3CPSD20

Con soffione da 20x20 cm.
 With head shower 20x20 cm.

CR

RX636DA3CPSD25

Con soffione da 25x25 cm.
 With head shower 25x25 cm.

CR

RX636DA3CPSD30

Con soffione da 30x30 cm.
 With head shower 30x30 cm.

CR



Set colonna doccia, composto da: miscelatore esterno per colonna REFLEX, colonna telescopica ad altezza regolabile con deviatore, flessibile doccia 150cm, soffione in abs, doccetta in ABS a 3 funzioni con pulsante per il cambio dell'intensità,
Shower column set, including: exposed mixer for column REFLEX, height-adjustable telescopic column with diverter, 150cm flexible hose, abs shower head, 3-function abs hand shower with button for switching jet modes.

RX636A3CPSD20

Con soffione da 20x20 cm.
 With head shower 20x20 cm.

CR

RX636A3CPSD25

Con soffione da 25x25 cm.
 With head shower 25x25 cm.

CR

RX636A3CPSD30

Con soffione da 30x30 cm.
 With head shower 30x30 cm.

CR

REFLEX

OMEGA

SMART

OMEGA GREEN

SMART GREEN

— KIT WELLNESS - WELLNESS KIT —



Set doccia a incasso, composto da: miscelatore a incasso con deviatore REFLEX, asta saliscendi, attacco presa acqua a muro, braccio a muro in ottone 30cm, soffione in abs, doccetta in ABS a 3 funzioni con pulsante per il cambio dell'intensità, flessibile 150cm.

Built-in shower set, including: built-in mixer with diverter REFLEX, sliding rail, wall water connection, 30cm brass wall arm, abs shower head, 3-function abs hand shower with button for switching jet modes, 150cm flexible hose.

RX614ZSD20

Con soffione da 20x20 cm.
With head shower 20x20 cm.

— CR —

RX614ZSD25

Con soffione da 25x25 cm.
With head shower 25x25 cm.

— CR —

RX614ZSD30

Con soffione da 30x30 cm.
With head shower 30x30 cm.

— CR —



Set doccia a incasso, composto da: miscelatore a incasso con deviatore REFLEX, attacco presa acqua a muro con supporto per doccetta, braccio a muro in ottone 30cm, soffione in abs, doccetta in ABS a 3 funzioni con pulsante per il cambio dell'intensità, flessibile 150cm.

Built-in shower set, including: built-in mixer with diverter REFLEX, wall water connection with hand shower holder, 30cm brass wall arm, abs shower head, 3-function abs hand shower with button for switching jet modes, 150cm flexible hose.

RX615ZSD20

Con soffione da 20x20 cm.
With head shower 20x20 cm.

— CR —

RX615ZSD25

Con soffione da 25x25 cm.
With head shower 25x25 cm.

— CR —

RX615ZSD30

Con soffione da 30x30 cm.
With head shower 30x30 cm.

— CR —



Set doccia a incasso, composto da: miscelatore a incasso con deviatore REFLEX piastra G, asta saliscendi, attacco presa acqua a muro, braccio a muro in ottone 30cm, soffione ultra piatto in acciaio INOX lucidato a specchio, doccetta in ABS a 3 funzioni con pulsante per il cambio dell'intensità, flessibile 150cm.

Built-in shower set, including: built-in mixer with diverter REFLEX G plate, sliding rail, wall water connection, 30cm brass wall arm, ultra-flat shower head in mirror-polished stainless steel, 3-function abs hand shower with button for jets mode switching, 150cm flexible hose.

RX614GZ7920

Con soffione da 20x20 cm.
With head shower 20x20 cm.

— CR — 15 —

RX614GZ7925

Con soffione da 25x25 cm.
With head shower 25x25 cm.

— CR — 15 —

RX614GZ7930

Con soffione da 30x30 cm.
With head shower 30x30 cm.

— CR — 15 —



Set doccia a incasso, composto da: miscelatore a incasso con deviatore REFLEX piastra G, attacco presa acqua a muro con supporto per doccetta, braccio a muro in ottone 30cm, soffione ultra piatto in acciaio INOX lucidato a specchio, doccetta in ABS a 3 funzioni con pulsante per il cambio dell'intensità, flessibile 150cm.

Built-in shower set, including: built-in mixer with diverter REFLEX G plate, wall water connection with hand shower holder, 30cm brass wall arm, ultra-flat shower head in mirror-polished stainless steel, 3-function abs hand shower with button for jets mode switching, 150cm flexible hose.

RX615GZ7920

Con soffione da 20x20 cm.
With head shower 20x20 cm.

— CR — 15 —

RX615GZ7925

Con soffione da 25x25 cm.
With head shower 25x25 cm.

— CR — 15 —

RX615GZ7930

Con soffione da 30x30 cm.
With head shower 30x30 cm.

— CR — 15 —



Set doccia a incasso, composto da: miscelatore a incasso su piastra unica con deviatore a 2 vie, presa acqua con doccetta in ottone e flessibile 150 cm, braccio a muro in ottone 30cm, soffione in abs.
Built-in shower set, including: built-in mixer on 1 plate with 2-way diverter, water intake with brass hand-shower and 150cm hose, 30cm brass wall arm, abs shower head.

RX715ZD2LSD20

Con soffione da 20x20 cm.
 With head shower 20x20 cm.

CR

RX715ZD2LSD25

Con soffione da 25x25 cm.
 With head shower 25x25 cm.

CR

RX715ZD2LSD30

Con soffione da 30x30 cm.
 With head shower 30x30 cm.

CR



Set doccia a incasso, composto da: miscelatore a incasso con deviatore su piastra rettangolare REFLEX, asta saliscendi in ottone, attacco presa acqua a muro, braccio a muro in ottone 30cm, soffione in ottone, doccetta quadrata in ottone a 1 funzione, flessibile 150cm.
Built-in shower set, including: built-in mixer with diverter on rectangular flange REFLEX, brass sliding rail, wall water connection, 30cm brass wall arm, brass shower head, 1-function squared brass hand shower, 150cm flexible hose.

RX614ZOL

Con soffione da 20x20 cm.
 With head shower 20x20 cm.

CR FIN A FIN B

RX614ZOL93B

Con soffione da 30x30 cm.
 With head shower 30x30 cm.

CR FIN A FIN B



Set doccia a incasso, composto da: miscelatore a incasso con deviatore su piastra rettangolare REFLEX, attacco presa acqua a muro con supporto per doccetta, braccio a muro in ottone 30cm, soffione in ottone, doccetta quadrata in ottone a 1 funzione, flessibile 150cm.
Built-in shower set, including: built-in mixer with diverter on rectangular flange REFLEX, wall water connection with hand shower holder, 30cm brass wall arm, brass shower head, 1-function squared brass hand shower, 150cm flexible hose.

RX615ZOL

Con soffione da 20x20 cm.
 With head shower 20x20 cm.

CR FIN A FIN B

RX615ZOL93B

Con soffione da 30x30 cm.
 With head shower 30x30 cm.

CR FIN A FIN B



Set doccia a incasso, composto da: miscelatore a incasso su 3 piastre tonde con deviatore a 2 vie, presa acqua con doccetta in ottone e flessibile 150 cm, braccio a muro in ottone 30cm, soffione 20x20cm in ottone.
 NB: miscelatore, deviatore e doccetta hanno piastre esterne separate, ma un'unica parte a incasso.
Built-in shower set, including: built-in mixer on 1 plate with 2-way diverter, water intake with brass hand-shower and 150cm hose, 30cm brass wall arm, 20x20cm brass shower head.
 NB: mixer, diverter and hand-shower intake are on separate plates, but share one single built-in part.

RX715ZOD2PL

Con soffione da 20x20 cm.
 With head shower 20x20 cm.

CR FIN A FIN B

RX715ZOD2PL93B

Con soffione da 30x30 cm.
 With head shower 30x30 cm.

CR FIN A FIN B

CUCINA - KITCHEN



RX681M

Miscelatore monocomando per lavello, con canna alta girevole e doccetta estraibile con impugnatura a martello a due funzioni.
Single-lever sink mixer with high swivel spout and 2-functions pull-out "hammer shaped" handle hand shower.

CR



RX684DJ

Miscelatore monocomando per lavello, con canna alta girevole e doccetta estraibile a due funzioni.
Single-lever sink mixer with high swivel spout and 2-functions pull-out hand shower.

CR



RX684

Miscelatore monocomando per lavello, con canna alta girevole e sistema di doccetta monofunzione estraibile.
Single-lever sink mixer with high swivel spout and single-function system pull-out hand shower.

CR FIN A FIN B



RX618

Miscelatore monocomando per lavello, monoforo 90°, con canna alta girevole.
Single-lever sink mixer 90° with high swivel spout.

CR FIN A FIN B



RX618U

Miscelatore monocomando monoforo 90° per lavello, con canna alta girevole.
Single-lever sink mixer 90°, with high wivel spout.

CR FIN A FIN B



RX618Q

Miscelatore monocomando per lavello, con bocca alta girevole.
Single lever kitchen mixer with high swivel spout.

CR FIN A FIN B



RX618C

Miscelatore monocomando per lavabo/lavello con canna corta girevole, tipo lusso. Scarico non incluso.
Single-lever basin/sink mixer with short swivel spout, luxury type. Waste not included.

CR FIN A FIN B



RX614B

Miscelatore monocomando per lavello, con bocca alta girevole.
Single-lever one-hole sink mixer, with high swivel spout.

CR FIN A FIN B



RX614R

Miscelatore monocomando lavello per installazione sottofinestra, con bocca alta girevole e reclinabile, tipo lusso.
Single-lever sink mixer for under window installation, with high swivel reclining spout, luxury type.

CR FIN A FIN B

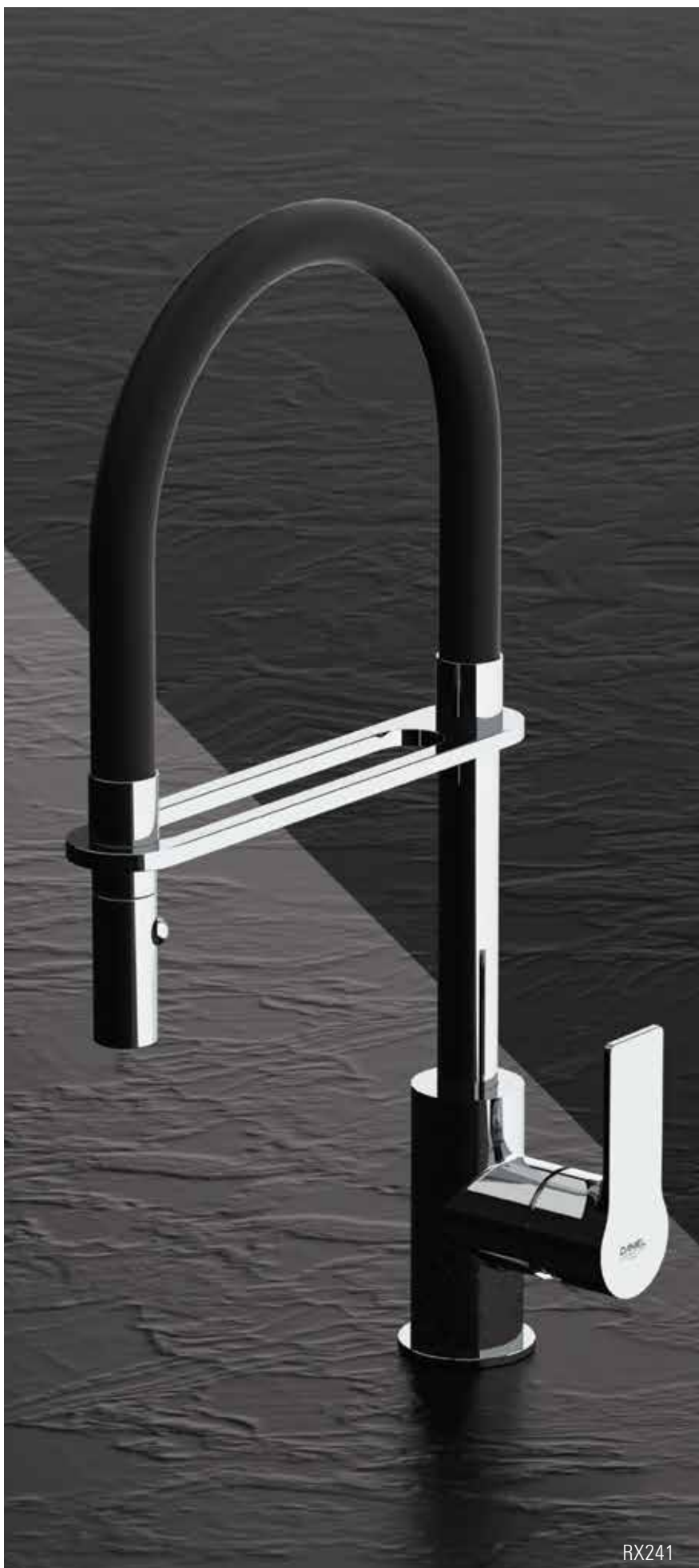

RX241

GOURMET



RX241

Miscelatore lavello con flessibile rivestito in tubo gomma soft-touch nero opaco.
Sink mixer with flexible hose coated in soft-touch matt black rubber pipe.

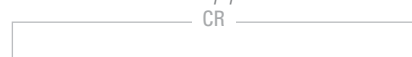

RX689

Miscelatore monocomando lavello a molla con doccetta estraibile dal supporto ed orientabile a due funzioni.
Spring single-lever sink mixer with detachable and adjustable 2-functions handshower.



ACQUA DEPURATA
PURIFIED WATER



RX679DW

Miscelatore lavello a 3 vie di ingresso con bocca girevole e due vie d'uscita completamente indipendenti per acqua depurata e acqua corrente. Selezione dell'acqua depurata tramite deviatore laterale.
3-ways sink mixer with swivel spout and two completely independent outlets for purified water and running water. Selection of purified water from side diverter.



REFLEX

OMEGA

SMART

OMEGA GREEN

SMART GREEN

OMEGA

Le linee dolci e tondeggianti della collezione OMEGA si intervallano a superfici piatte e riflettenti, tracciando un netto parallelismo tra la bocca e leva del miscelatore e definendo i profili di un'estetica essenziale. Una serie curata in ogni dettaglio, come ad esempio il tettuccio di protezione dell'aeratore nel miscelatore da bidet, in grado di soddisfare le esigenze di stile anche nei progetti a budget contenuto.

The soft and round lines of OMEGA collection alternate with flat and reflective surfaces, drawing a clear parallel between spout and mixer lever and defining the essential aesthetics profiles. A series with attention to every detail, such as the aerator protection shield in bidet mixer, able to satisfy the style demands even in low budget projects.



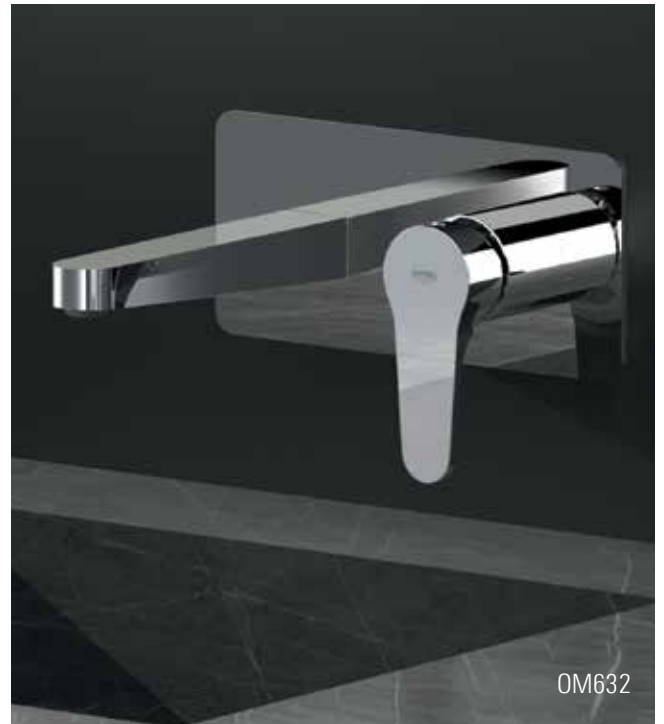

CARATTERISTICHE TECNICHE:

La serie è dotata di cartuccia a dischi ceramici, Ø 35 mm, prodotta da S.T.S.R. – Studio Tecnico Sviluppo e Ricerche - www.stsr.it

TECHNICAL FEATURES:

The series is equipped with ceramic cartridge, Ø 35 mm, produced by S.T.S.R. - Research Development Technical Office - www.stsr.it



OM606N15

15
NERO OPACO
MATT BLACK

LAVABI - WASHBASIN MIXERS



OM605

Monocomando lavabo, con scarico.
Single-lever basin mixer, with pop-up waste.

CR FIN A FIN B



OM607

Monocomando lavabo alto, con scarico.
High basin mixer, with pop-up waste.

CR FIN A FIN B



OM607X

Monocomando lavabo XL., con scarico click-clack.
XL basin mixer, with click-clack waste.

CR FIN A FIN B

OM606N

Monocomando lavabo, senza scarico e senza foro sul corpo.

Single-lever basin mixer, without waste and without body hole.

CR FIN A FIN B

OM607BN

Monocomando lavabo alto, senza scarico e senza foro sul corpo.

High basin mixer, without waste and without body hole.

CR FIN A FIN B

OM607XB

Monocomando lavabo XL., senza scarico.

XL basin mixer, without waste.

CR FIN A FIN B



OM632

Miscelatore monocomando a incasso per lavabo, con piastra rettangolare.

Lunghezza bocca: 18 cm.

Single-lever built-in basin mixer, with rectangular wall flange. Spout length: 18 cm.

CR FIN A FIN B

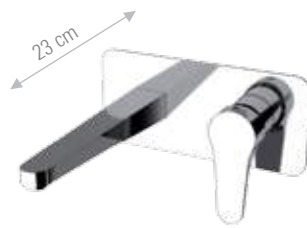

OM632L

Miscelatore monocomando a incasso per lavabo, con piastra rettangolare.

Lunghezza bocca: 23 cm.

Single-lever built-in basin mixer, with rectangular wall flange. Spout length: 23 cm.

CR FIN A FIN B



OM655

Miscelatore monocomando a due fori per lavabo. Scarico non incluso.

Two-hole single-lever washbasin mixer. Waste not included.

CR FIN A FIN B



OM655L

Miscelatore monocomando a due fori per lavabo. Scarico non incluso.

Two-hole single-lever washbasin mixer. Waste not included.

CR FIN A FIN B

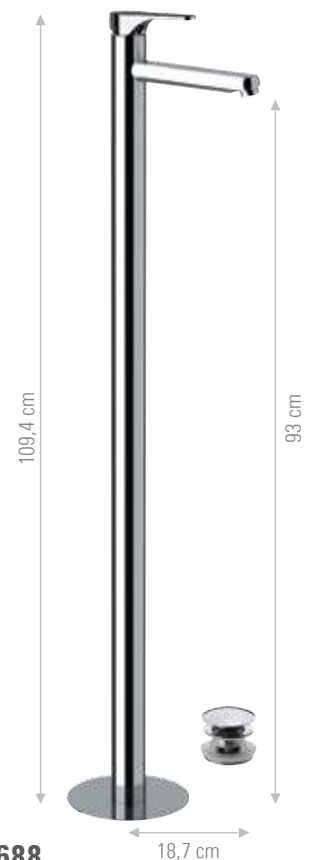

OM688

Miscelatore monocomando lavabo da pavimento con click-clack e troppo pieno.

Single-lever mixer floor mounting with click-clack and overflow.

CR FIN A FIN B

— LAVABO BOX INCASSO - BUILT-IN BOX WASHBASIN MIXER —



OM632KB

Miscelatore monocomando a incasso per lavabo, con piastra in ottone, bocca lunghezza 18 cm, da abbinare al box incasso.
Single-lever built-in basin mixer, with wall flange in brass, spout length 18 cm, to use with the built-in box.

CR FIN A FIN B



OM632LKB

Miscelatore monocomando a incasso per lavabo, con piastra in ottone, bocca lunghezza 23 cm, da abbinare al box incasso.
Single-lever built-in basin mixer, with wall flange in brass, spout length 23 cm, to use with the built-in box.

CR FIN A FIN B



DANBOX632

Box incasso per miscelatore monocomando a incasso per lavabo.
Built-in box for single-lever built-in basin mixer.

CR

— BIDET —



OM604

Miscelatore bidet, con scarico.
Bidet mixer, with pop-up waste.

CR FIN A FIN B



OM604BN

Miscelatore bidet, senza scarico e senza foro sul corpo.
Bidet mixer, without waste and without body hole.

CR FIN A FIN B



OM646

Miscelatore incasso per shut-off.
Built-in shut-off mixer.

CR FIN A FIN B



OM645

Miscelatore incasso per shut-off serie Omega su piastra in ottone cromato, comprensivo di doccetta shut-off art. 1000DC, supporto doccia-presa acqua, tutto in ottone cromato e flessibile doccia cm 120.
Omega model built-in shower mixer all in c.p. brass, including shut-off art. 1000DC, shower holder-water punch on flange, all in c.p. brass and shower flexible cm 120.

CR FIN A FIN B



OM642

Miscelatore incasso per shut-off con doccetta shut-off, supporto doccia, presa acqua.
Built-in shut-off mixer set shut-off, shower holder, water punch.

CR FIN A FIN B



OM605SH4DC

Miscelatore monocomando lavabo con doccia shut-off e scarico click-clack con troppo pieno.
Single-lever basin mixer with shut-off handshower and click-clack pop-up waste with overflow.

CR FIN A FIN B

MISCELATORI VASCA E DOCCIA - BATH & SHOWER MIXERS



OM610

Miscelatore vasca esterno, con kit doccia, flessibile 150 cm.
Exposed bath mixer, with shower kit, flexible 150 cm.

CR FIN A FIN B



OM611A

Monocomando doccia esterno, con kit doccia
Exposed shower mixer, with shower kit

CR FIN A FIN B



OM606D

Miscelatore monocomando per vasca, con deviatore integrato e kit doccia.
Single lever bath mixer, with diverter and shower kit.

CR FIN A FIN B



OM600H

Miscelatore vasca esterno, senza kit doccia.
Exposed bath mixer, without shower kit.

CR FIN A FIN B



OM611

Monocomando doccia esterno, senza kit doccia
Exposed shower mixer, without shower kit

CR FIN A FIN B



OM606DH









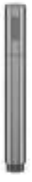

Miscelatore monocomando per vasca, senza kit doccia.
Single lever bath mixer, without shower kit.

CR FIN A FIN B



DOCCETTA IN FINITURA
FINISH HAND SHOWER

Il modello della doccetta inclusa nel kit può variare in base alla finitura scelta.
The model of the hand shower included in the kit may vary according to the chosen finish.

CR	FIN A						FIN B				
											
Doccetta abs, 1 funzioni. ABS hand shower, 1-function.	Doccetta minimale in ottone, 1 funzioni. Minimal brass hand shower, 1-function.										



OM624

Miscelatore lavabo/vasca con canna fusa lunga e con deviatore, con kit doccia
Wall basin/bath single lever mixer with long casted spout and diverter, with shower kit.

CR FIN A FIN B



OM624H

Miscelatore lavabo/vasca con canna fusa lunga e con deviatore, senza kit doccia
Wall basin/bath single lever mixer with long casted spout and diverter, without shower kit.

CR FIN A FIN B

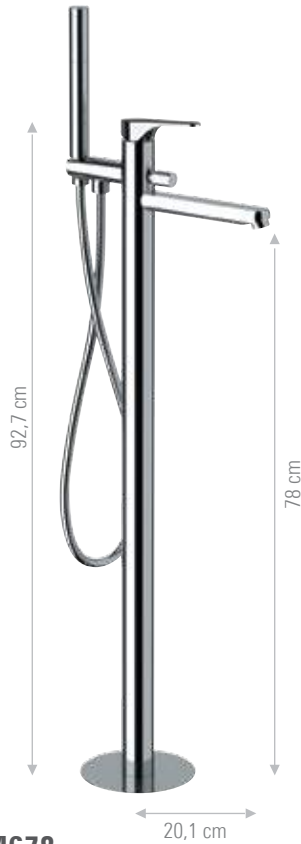

OM678

Miscelatore vasca da pavimento con deviatore e kit doccia con doccetta in ottone 1 funzione.
Free standing bath mixer floor mounting with diverter and shower kit, including 1-function brass hand shower.

CR FIN A FIN B



OM691

Set miscelatore monocomando bordo vasca con doccetta in ottone a 1 funzione.
Single lever deck bath/shower mixer set with 1-function brass hand shower.

CR FIN A FIN B



OM699

Set miscelatore monocomando bordo vasca con bocca multigetto e doccetta in ottone 1 funzione.
Single lever deck bath/shower mixer with multijet spout and 1-function brass hand shower.

CR FIN A FIN B

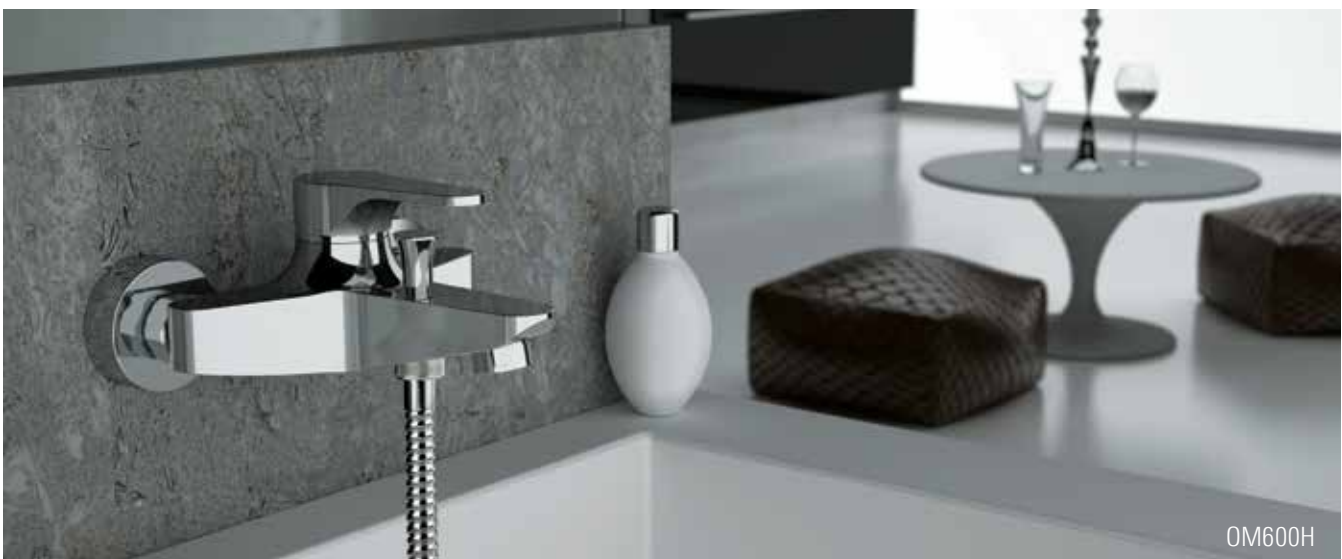

OM600H

□ □ □ 2 VIE - 2-WAY □ □ □



OM700D2

Set miscelatore a incasso a 2 vie per vasca/doccia su piastra unica rettangolare, include miscelatore monocomando, deviatore a 2 uscite, bocca a muro. Da completare con una seconda uscita acqua.
2-way built-in mixer set for bathtub / shower on single rectangular plate, including single-lever mixer, 2-way diverter, wall spout. To be completed with a second water outlet.

CR FIN A FIN B

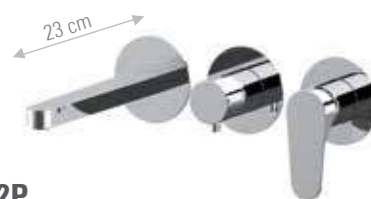

OM700D2P

Set miscelatore a incasso a 2 vie per vasca/doccia su 3 piastre tonde separate (piastre separate e incasso unico), include: miscelatore monocomando, deviatore a 2 uscite, bocca a muro. Da completare con una seconda uscita.
2-way built-in mixer set for bathtub / shower on 3 separate round plates (separate plates, one single built-in part), including: single-lever mixer, 2-way diverter, wall spout. To be completed with a second water outlet.

CR FIN A FIN B



OM710D2

Set a incasso a 2 vie per vasca, include: miscelatore monocomando, deviatore a 2 uscite e bocca a muro su piastra unica rettangolare; set doccia su piastra quadrata con presa acqua, supporto integrato, doccetta in ottone e flessibile 150cm.
2-way built-in set for bathtub, including: single-lever mixer, 2-way diverter and wall spout on a single rectangular plate; shower set on square plate with water connection, holder, brass handshower and 150cm flexible hose.

CR FIN A FIN B



OM710D2P

Set a incasso a 2 vie per vasca su piastre tonde separate (3 piastre separate e incasso unico), include: miscelatore monocomando con deviatore a 2 uscite, bocca a muro; set doccia su piastra tonda con presa acqua, supporto, doccetta e flessibile 150cm.
2-way built-in set for bathtub on separate round plates (3 separate plates, one single built-in part), including: single-lever mixer, 2-way diverter, wall spout; Shower set on round plate with water connection, holder, hand shower and 150cm flexible hose.

CR FIN A FIN B

□ □ □ 3 VIE - 3-WAY □ □ □

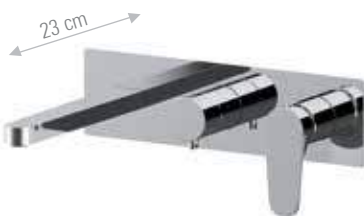

OM700D3

Set miscelatore a incasso a 3 vie per vasca/doccia su piastra unica rettangolare, include miscelatore monocomando, deviatore a 3 uscite, bocca a muro. Da completare con una seconda e una terza uscita acqua.
3-way built-in mixer set for bathtub/shower on single rectangular plate, including single-lever mixer, 3-way diverter, wall spout. To be completed with second and third water outlets.

CR FIN A FIN B



OM700D3P

Set miscelatore a incasso a 3 vie per vasca/doccia su 3 piastre tonde separate (piastre separate e parte a incasso unica), composto da: miscelatore monocomando con deviatore a 3 uscite, bocca a muro. Da completare con una seconda e una terza uscita acqua.
3-way built-in mixer set for bathtub/shower on 3 separate round plates (separate plates, one single built-in part), including: single-lever mixer with 3-way diverter, wall spout. To be completed with second and third water outlets.

CR FIN A FIN B

INCASSI DOCCIA - BUILT-IN MIXERS

□ □ □ 1 VIA - 1-WAY □ □ □



OM602G

Miscelatore incasso per doccia (articolo COMPLETO).
Built-in shower mixer (COMPLETE item).

CR FIN A FIN B

IN602C35

SOLO parti a incasso
Built-in parts ONLY.

CR FIN A FIN B

OM602GEKIT

SOLO parti esterne.
Exposed parts ONLY.

CR FIN A FIN B



OM602

Miscelatore incasso per doccia su piastra tonda (articolo COMPLETO).
Built-in shower mixer on round plate (COMPLETE item).

CR FIN A FIN B

IN602C35

SOLO parti a incasso
Built-in parts ONLY.

CR FIN A FIN B

OM602EKIT

SOLO parti esterne.
Exposed parts ONLY.

CR FIN A FIN B



OM602B

Miscelatore incasso per doccia su piastra Omega (articolo COMPLETO).
Built-in shower mixer on Omega plate (COMPLETE item).

CR FIN A FIN B

IN602C35

SOLO parti a incasso
Built-in parts ONLY.

CR FIN A FIN B

OM602BEKIT

SOLO parti esterne.
Exposed parts ONLY.

CR FIN A FIN B

REFLEX

OMEGA

SMART

OMEGA GREEN

SMART GREEN

□ □ □ 2 VIE - 2-WAY □ □ □



OM612G

Miscelatore incasso con deviatore per vasca/doccia (articolo **COMPLETE**).
Built-in bath/shower mixer with diverter (COMPLETE item).

CR FIN A FIN B

IN612C35

SOLO parti a incasso
Built-in parts ONLY.

CR FIN A FIN B

OM612GEKIT

SOLO parti esterne.
Exposed parts ONLY.

CR FIN A FIN B



OM612

Miscelatore incasso con deviatore per vasca/doccia su piastra tonda (articolo **COMPLETE**).
Built-in bath/shower mixer with diverter on round plate (COMPLETE item).

CR FIN A FIN B

IN612C35

SOLO parti a incasso
Built-in parts ONLY.

CR FIN A FIN B

OM612EKIT

SOLO parti esterne.
Exposed parts ONLY.

CR FIN A FIN B



OM612B

Miscelatore incasso con deviatore per vasca/doccia su piastra Omega (articolo **COMPLETE**).
Built-in bath/shower mixer with diverter on Omega plate (COMPLETE item).

CR FIN A FIN B

IN612C35

SOLO parti a incasso
Built-in parts ONLY.

CR FIN A FIN B

OM612BEKIT

SOLO parti esterne.
Exposed parts ONLY.

CR FIN A FIN B



OM612D2

Miscelatore incasso con deviatore a 2 vie per vasca/doccia su piastra lusso ultrapiatta (articolo COMPLETO).

Built-in bath/shower mixer with 2-way diverter on luxury ultraslim plate (COMPLETE item).

CR FIN A FIN B



OM712D2

Set miscelatore a incasso a 2 vie per doccia su piastra unica rettangolare, include presa acqua con supporto, doccetta e flessibile 150 cm.

Da completare con una 2° uscita.
2-way built-in shower mixer set on a single rectangular plate, including water connection with shower holder, hand shower and 150cm hose. To be completed with a 2nd water outlet.

CR FIN A FIN B



OM712D2P

Set miscelatore a incasso a 2 vie per doccia su 3 piastre tonde separate (parte a incasso unica), include: miscelatore e deviatore a 2 uscite, presa acqua con supporto, doccetta in ottone e flessibile 150 cm.

Da completare con una 2° uscita.
2-way built-in shower mixer set on 3 separate round plates (single built-in part), including: mixer and 2-way diverter, water connection with holder, brass hand shower and 150cm flexible hose. To be completed with a 2nd water outlet.

CR FIN A FIN B

□ □ □ 3 VIE - 3-WAY □ □ □



OM612D3

Miscelatore incasso con deviatore a 3 vie per vasca/doccia , 1 entrata e 3 uscite (articolo COMPLETO).

Built-in bath/shower mixer with 3-way diverter, 1 inlet and 3 outlets (COMPLETE item).

CR FIN A FIN B



OM712D3

Set miscelatore a incasso a 3 vie per doccia su piastra unica rettangolare, include: miscelatore, deviatore a 3 uscite, presa acqua con supporto, doccetta in ottone e flessibile 150 cm.

Da completare con una 2° ed una 3° uscita.
3-way built-in shower mixer set on a single rectangular plate, including: single-lever mixer, 3-way diverter, water connection with shower holder, brass hand shower and 150cm flexible hose. To be completed with a 2nd and 3rd water outlet.

CR FIN A FIN B



OM712D3P

Set miscelatore a incasso a 3 vie per doccia su 3 piastre tonde separate (parte a incasso unica), include: miscelatore e deviatore a 3 uscite, presa acqua con supporto, doccetta in ottone e flessibile 150cm.

Da completare con una 2° ed una 3° uscita.
3-way built-in shower mixer set on 3 separate round plates (single built-in part), including: mixer and 3-way diverter, water connection with holder, brass hand-shower and 150cm flexible hose. To be completed with a 2nd and 3rd water outlet.

CR FIN A FIN B

□ □ □ 4/5 VIE - 4/5-WAY □ □ □



OM612D4

Miscelatore incasso con deviatore a 4 vie per vasca/doccia , 1 entrata e 4 uscite (articolo COMPLETO).

Built-in bath/shower mixer with 4-way diverter, 1 inlet and 4 outlets (COMPLETE item).

CR FIN A FIN B



OM612D5

Miscelatore incasso con deviatore a 5 vie per vasca/doccia , 1 entrata e 5 uscite (articolo COMPLETO).

Built-in bath/shower mixer with 5-way diverter, 1 inlet and 5 outlets (COMPLETE item).

CR FIN A FIN B

BOCCHE - SPOUTS

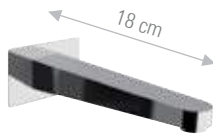

OM4704

Bocca incasso. Lunghezza bocca: 18 cm.
Built-in spout. Spout length: 18 cm.

CR FIN A FIN B

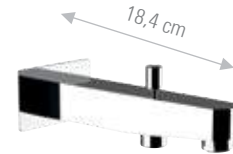

OM4702

Bocca incasso con deviatore.
Built-in spout with diverter.

CR FIN A FIN B

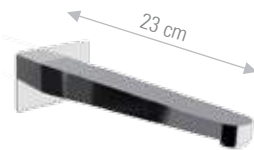

OM4704L

Bocca incasso. Lunghezza bocca: 23 cm.
Built-in spout. Spout length: 23 cm.

CR FIN A FIN B



F4705

Bocca bordo vasca con effetto multigetto.
Spout with multijet effect for deck bath/shower mixer.

CR FIN A FIN B

COLONNE DOCCIA - SHOWER COLUMN



Set colonna vasca/doccia a 3 vie, composto da: miscelatore esterno vasca/doccia per colonna con deviatore OMEGA, colonna telescopica ad altezza regolabile, soffione ultra piatto in acciaio INOX lucidato a specchio, doccetta in ABS a 4 funzioni con pulsante per il cambio dell'intensità, flessibile 150cm.
3-way bath/shower column set, including: exposed bath/shower mixer for column with diverter OMEGA, height-adjustable telescopic column, ultra-flat shower head in mirror-polished stainless steel, 4-function abs hand shower with button for jets mode switching, 150cm flexible hose.

OM636DA3MP7820

Con soffione da Ø20 cm.
With head shower Ø20 cm.

CR 15

OM636DA3MP7825

Con soffione da Ø25 cm.
With head shower Ø25 cm.

CR 15

OM636DA3MP7830

Con soffione da Ø30 cm.
With head shower Ø30 cm.

CR 15



Set colonna a 3 vie, composto da: miscelatore esterno vasca/doccia per colonna con deviatore OMEGA, colonna telescopica ad altezza regolabile, soffione in abs, doccetta in ABS a 4 funzioni con pulsante per il cambio dell'intensità, flessibile 150cm.
3-way bath/shower column set, including: exposed bath/shower mixer for column with diverter OMEGA, height-adjustable telescopic column, abs shower head, 4-function abs hand shower with button for jets mode switching, 150cm flexible hose.

OM636DA3MP8420

Con soffione da Ø20 cm.
With head shower Ø20 cm.

CR

OM636DA3MP8425

Con soffione da Ø25 cm.
With head shower Ø25 cm.

CR

OM636DA3MP8430

Con soffione da Ø30 cm.
With head shower Ø30 cm.

CR

KIT WELLNESS - WELLNESS KIT



OM61420

Set doccia a incasso, composto da: miscelatore a incasso con deviatore OMEGA, asta saliscendi in ottone, attacco presa acqua a muro, braccio a muro in ottone 30cm, soffione Ø 20 cm in ottone, doccetta in ottone a 1 funzione, flessibile 150cm.

Built-in shower set, including: built-in mixer with diverter OMEGA, brass sliding rail, wall water connection, 30cm brass wall arm, Ø 20cm brass shower head, 1-function brass hand shower, 150cm flexible hose.

CR

FIN A

FIN B



OM61520

Set doccia a incasso, composto da: miscelatore a incasso con deviatore OMEGA, attacco presa acqua a muro con supporto per doccetta, braccio a muro in ottone 30cm, soffione Ø 20 cm in ottone, doccetta in ottone a 1 funzione, flessibile 150cm.

Built-in shower set, including: built-in mixer with diverter OMEGA, wall water connection with hand shower holder, 30cm brass wall arm, Ø 20cm brass shower head, 1-function brass hand shower, 150cm flexible hose.

CR

FIN A

FIN B



OM614Z

Set doccia a incasso, composto da: miscelatore a incasso con deviatore OMEGA, asta saliscendi, attacco presa acqua a muro, braccio a muro in ottone 30cm, soffione Ø 20cm in abs, doccetta in abs a 1 funzione, flessibile 150cm.

Built-in shower set, including: built-in mixer with diverter OMEGA, sliding rail, wall water connection, 30cm brass wall arm, Ø 20cm abs shower head, 1-function abs hand shower, 150cm flexible hose.

CR



OM615Z

Set doccia a incasso, composto da: miscelatore a incasso con deviatore OMEGA, attacco presa acqua a muro con supporto per doccetta, braccio a muro in ottone 30cm, soffione Ø 20cm in abs, doccetta in abs a 1 funzione, flessibile 150cm.

Built-in shower set, including: built-in mixer with diverter OMEGA, wall water connection with hand shower holder, 30cm brass wall arm, Ø 20cm abs shower head, 1-function abs hand shower, 150cm flexible hose.

CR



OM614ZL3MPEC20

Set doccia a incasso, composto da: miscelatore a incasso con deviatore su piastra tonda OMEGA, asta saliscendi, attacco presa acqua a muro, braccio a muro in ottone 30cm, soffione Ø 20 cm in abs cromato, doccetta in ABS a 4 funzioni con pulsante per il cambio dell'intensità, flessibile 150cm.

Built-in shower set, including: built-in mixer with diverter on round plate OMEGA, sliding rail, wall water connection, 30cm brass wall arm, Ø 20cm abs shower head, 4-function abs hand shower with button for jets mode switching, 150cm flexible hose.

CR



OM615ZL3MPEC20

Set doccia a incasso, composto da: miscelatore a incasso con deviatore su piastra tonda OMEGA, attacco presa acqua a muro con supporto per doccetta, braccio a muro in ottone 30cm, soffione Ø 20 cm in abs cromato, doccetta in ABS a 4 funzioni con pulsante per il cambio dell'intensità, flessibile 150cm.

Built-in shower set, including: built-in mixer with diverter on round plate OMEGA, wall water connection with hand shower holder, 30cm brass wall arm, Ø 20cm abs shower head, 4-function abs hand shower with button for jets mode switching, 150cm flexible hose.

CR

CUCINA - KITCHEN



OM618

Miscelatore lavello monoforo 90° con canna alta girevole.
Single-lever sink mixer 90° with high movable spout.

CR FIN A FIN B



OM618U

Miscelatore lavello monoforo 90° con canna alta girevole e leva laterale.
Single-lever sink mixer 90° with high movable spout and side lever.

CR FIN A FIN B



OM618C

Miscelatore lavello monoforo 90° con canna alta girevole, modello corto.
Single-lever sink mixer 90° with high movable spout, short type.

CR FIN A FIN B



OM617

Miscelatore lavello monoforo 45° con canna alta girevole.
Single-lever sink mixer 45° with high movable spout.

CR FIN A FIN B



OM614B

Miscelatore monocomando per lavello, con bocca alta girevole.
Single-lever one-hole sink mixer, with high movable spout.

CR FIN A FIN B



OM614BC

Miscelatore monocomando per lavello, con canna corta girevole.
Single-lever one-hole sink mixer, with short movable spout.

CR FIN A FIN B



OM633B

Miscelatore lavello a muro, con leva frontale e canna alta girevole.
Single-lever wall mounted sink mixer with frontal lever and high movable spout.

CR FIN A FIN B



OM633

Miscelatore lavello a muro, con leva frontale e bocca girevole.
Single-lever wall mounted sink mixer with frontal lever and movable spout.

CR FIN A FIN B



OM614R

Miscelatore monocomando lavello per installazione sottofinestra, con bocca alta girevole e reclinabile, tipo lusso.
Single-lever sink mixer for under window installation, with high swivel reclining spout, luxury type.

CR FIN A FIN B

**OM614T**

Miscelatore lavello monoforo 45° con bocca alta girevole.
Single-lever sink mixer 45° with high movable spout.

**OM614C**

Miscelatore lavello monoforo 45° con canna fusa corta.
Single-lever sink mixer 45° with short movable casted spout.

**OM614TC**

Miscelatore lavello monoforo 45° con bocca corta girevole.
Single-lever sink mixer 45° with short movable spout.

**OM629**

Monocomando lavello con canna girevole.
Single-lever sink mixer with swiveling spout.

**OM609T**

Miscelatore lavello a muro con canna girevole.
Wall-mounted single-lever sink mixer with movable spout.

**OM609S**

Miscelatore lavello a muro con bocca ad "S" girevole.
Wall-mounted single-lever sink mixer with "S" movable spout.

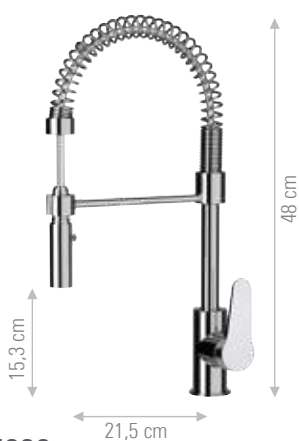

GOURMET

ACQUA DEPURATA
PURIFIED WATER**OM689**

Miscelatore lavello monocomando a molla con doccetta estraibile ed orientabile a due funzioni e cartuccia Ø35 mm.
Spring single-lever sink mixer with pull-out and swivelling 2 functions hand shower and Ø35 mm cartridge.

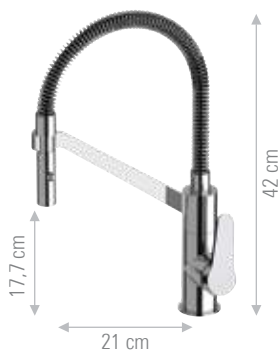
**OM233**

Miscelatore lavello monocomando a molla "fine design" girevole a 3600 con doccetta estraibile ed orientabile a due funzioni e cartuccia Ø35 mm.
Single-lever sink mixer with black flexible hose coated with "fine design" spring, 3600 movable, with pull-out and swivelling 2 functions hand shower and Ø35 mm cartridge.

**OM679DW**

Miscelatore lavello a tre vie di ingresso con bocca girevole e due vie d'uscita completamente indipendenti, con selezione acqua potabile tramite la leva.
Three ways inlet single lever sink mixer, with movable spout and two fully independent outlets, with selection for drinking water directly from the lever.



SMART

La collezione SMART è una linea di rubinetteria giovane che completa con note di semplicità ed eleganza gli arredi di bagno e cucina. Le superfici piatte e parallele di leva e bocca esprimono un design moderno, mentre l'apertura sulla maniglia alleggerisce e personalizza tutta la serie. Nella sua semplicità SMART può soddisfare tutte le composizioni bagno grazie alle diverse soluzioni di miscelatori per lavabo sia da incasso che da appoggio, oltre ai miscelatori a più vie per vasca e doccia.

The SMART collection is a line of young faucets that complete the bathroom and kitchen furnishings with notes of simplicity and elegance. The flat and parallel surfaces of lever and mouth express a modern design, while the opening on the handle lightens and characterizes the whole series. In its simplicity, SMART can satisfy all bathroom compositions thanks to the different solutions of both built-in and countertop basin mixers, as well as multi-way mixers for bath and shower.



SMART

SR606N



SR632



SR600H



SR604

CARATTERISTICHE TECNICHE:

La serie è dotata di cartuccia a dischi ceramici, Ø 35 mm, prodotta da S.T.S.R. – Studio Tecnico Sviluppo e Ricerche - www.stsr.it

TECHNICAL FEATURES:

The series is equipped with ceramic cartridge, Ø 35 mm, produced by S.T.S.R. - Research Development Technical Office - www.stsr.it



SR606N15

15
NERO OPACO
MATT BLACK

LAVABI - WASHBASIN MIXERS



SR605S
 Miscelatore monocomando per lavabo con scarico in ottone, versione small.
Single lever basin mixer with brass pop-up waste, small version.

CR FIN A FIN B



SR606S
 Miscelatore monocomando per lavabo, versione small, senza scarico.
Single lever basin mixer, without waste, small version.

CR FIN A FIN B



SR605
 Monocomando lavabo, con scarico.
Single-lever basin mixer, with pop-up waste.

CR FIN A FIN B

SR605SA
 Miscelatore monocomando per lavabo con scarico in ottone, versione small, con scarico in plastica.
Single lever basin mixer with brass pop-up waste, small version, with plastic pop-up waste.

CR FIN A FIN B

SR605A
 Monocomando lavabo, con scarico in plastica.
Single-lever basin mixer, with plastic pop-up waste.

CR

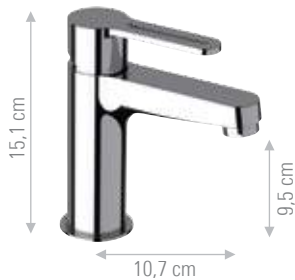

SR606N
 Monocomando lavabo, senza scarico e senza foro sul corpo.
Single-lever basin mixer, without waste and without body hole.

CR FIN A FIN B



SR607
 Monocomando lavabo XL, con scarico click-clack.
XL basin mixer, with click-clack waste.

CR FIN A FIN B



SR655
 Miscelatore monocomando a due fori per lavabo. Scarico non incluso.
Two-hole single-lever washbasin mixer. Waste not included.

CR FIN A FIN B

SR607B
 Monocomando lavabo XL, senza scarico.
XL basin mixer, without waste.

CR FIN A FIN B

SR655L
 Miscelatore monocomando lavabo due fori, con bocca L. Scarico non incluso.
Two holes single-lever washbasin mixer, with L spout. Waste not included.

CR FIN A FIN B

LAVABO BOX INCASSO BUILT-IN BOX WASHBASIN MIXER



SR632

Miscelatore monocomando a incasso per lavabo, con piastra rettangolare.

Lunghezza bocca: 18 cm.

Single-lever built-in basin mixer, with rectangular wall flange. Spout length: 18 cm.



SR632KB

Miscelatore monocomando a incasso per lavabo, con piastra in ottone, bocca lunghezza 18 cm, da abbinare al box incasso.

Single-lever built-in basin mixer, with wall flange in brass, spout length 18 cm, to use with the built-in box.



DANBOX632

Box incasso per miscelatore monocomando a incasso per lavabo.

Built-in box for single-lever built-in basin mixer.

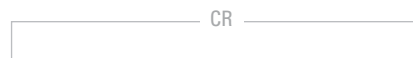

SR632L

Lunghezza bocca: 23 cm.

Spout length: 23 cm.



BIDET - BIDET MIXERS



SR604

Miscelatore bidet, con scarico.

Bidet mixer, with pop-up waste.



SR604A

Miscelatore bidet, con scarico in plastica.

Bidet mixer, with plastic pop-up waste.



SR604BN

Miscelatore bidet, senza scarico e senza foro sul corpo.

Bidet mixer, without waste and without body hole.



SR605SH4DC

Miscelatore monocomando lavabo con deviatore integrato, doccia shut-off e scarico click-clack con troppo pieno.

Single-lever basin mixer with integrated diverter shut-off handshower and click-clack pop-up waste with overflow.



SR645

Miscelatore incasso per shut-off su piastra in ottone cromato, comprensivo di doccetta shut-off art. 1000DC, supporto doccia-presa acqua, tutto in ottone cromato e flessibile doccia cm 120.

Built-in shower mixer all in c.p. brass, including shut-off art. 1000DC, shower holder-water punch on flange, all in c.p. brass and shower flexible cm 120.



SR642

Miscelatore incasso per shut-off con doccetta shut-off, supporto doccia, presa acqua.

Built-in shut-off mixer set shut-off, shower holder, water punch.



MISCELATORI VASCA E DOCCIA - BATH & SHOWER MIXERS



SR610

Miscelatore vasca esterno, con kit doccia, flessibile 150 cm.
Exposed bath mixer, with shower kit, flexible 150 cm.

CR FIN A FIN B



SR606D

Miscelatore monocomando per vasca, con deviatore integrato e kit doccia.
Single lever bath mixer, with diverter and shower kit.

CR FIN A FIN B



SR631A

Monocomando doccia esterno, con kit doccia, flessibile 150 cm.
Exposed shower mixer, with shower kit, flexible 150 cm.

CR FIN A FIN B

SR600H

Miscelatore vasca esterno, senza kit doccia.
Exposed bath mixer, without shower kit.

CR FIN A FIN B

SR606DH

Miscelatore monocomando per vasca, senza kit doccia.
Single lever bath mixer, without shower kit.

CR FIN A FIN B

SR631

Monocomando doccia esterno, senza kit doccia.
Exposed shower mixer, without shower kit.

CR FIN A FIN B



SR691

Miscelatore monocomando bordo vasca con doccetta in ABS cromato a 3 funzioni.
Single lever deck bath/shower mixer with c.p. ABS 3 functions handshower.

CR FIN A FIN B



SR698

Miscelatore monocomando bordo vasca con deviatore integrato nel miscelatore, bocca a cascata e doccetta in ABS cromato a 3 funzioni.
Single lever deck bath/shower mixer with diverter integrated in the mixer, waterfall spout and c.p. ABS 3 functions handshower.

CR FIN A FIN B



SR631Z









Miscelatore doccia esterno con attacco superiore.
Single lever deck shower mixer with upper connection.

CR FIN A FIN B



DOCCETTA IN FINITURA
FINISH HAND SHOWER

Il modello della doccetta inclusa nel kit può variare in base alla finitura scelta.
The model of the hand shower included in the kit may vary according to the chosen finish.

CR	FIN A						FIN B				
											
CR	15	14	NP	63	OIL	64	DO	DP	FZ	CF	RP
Doccetta abs, 3 funzioni. ABS hand shower, 3-function.	Doccetta minimale in ottone, 1 funzioni. Minimal brass hand shower, 1-function.										

□ □ □ 2 VIE - 2-WAY □ □ □

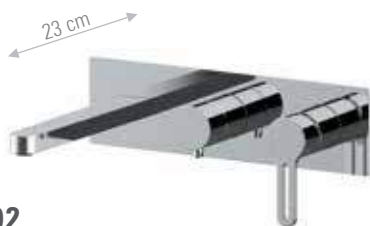
**SR700D2**

Set miscelatore a incasso a 2 vie per vasca/doccia su piastra unica rettangolare, include miscelatore monocomando, deviatore a 2 uscite, bocca a muro. Da completare con una seconda uscita acqua.
2-way built-in mixer set for bathtub / shower on single rectangular plate, including single-lever mixer, 2-way diverter, wall spout. To be completed with a second water outlet.

CR	FIN A	FIN B
----	-------	-------

**SR700D2P**

Set miscelatore a incasso a 2 vie per vasca/doccia su 3 piastre tonde separate (piastre separate e incasso unico), include: miscelatore monocomando, deviatore a 2 uscite, bocca a muro. Da completare con una seconda uscita.
2-way built-in mixer set for bathtub / shower on 3 separate round plates (separate plates, one single built-in part), including: single-lever mixer, 2-way diverter, wall spout. To be completed with a second water outlet.

CR	FIN A	FIN B
----	-------	-------

**SR710D2**

Set a incasso a 2 vie per vasca, include: miscelatore monocomando, deviatore a 2 uscite e bocca a muro su piastra unica rettangolare; set doccia su piastra quadrata con presa acqua, supporto integrato, doccetta in ottone e flessibile 150cm.
2-way built-in set for bathtub, including: single-lever mixer, 2-way diverter and wall spout on a single rectangular plate; shower set on square plate with water connection, holder, brass handshower and 150cm flexible hose.

CR	FIN A	FIN B
----	-------	-------

**SR710D2P**

Set a incasso a 2 vie per vasca su piastre tonde separate (3 piastre separate e incasso unico), include: miscelatore monocomando con deviatore a 2 uscite, bocca a muro; set doccia su piastra tonda con presa acqua, supporto, doccetta e flessibile 150cm.
2-way built-in set for bathtub on separate round plates (3 separate plates, one single built-in part), including: single-lever mixer, 2-way diverter, wall spout; Shower set on round plate with water connection, holder, handshower and 150cm flexible hose.

CR	FIN A	FIN B
----	-------	-------

□ □ □ 3 VIE - 3-WAY □ □ □

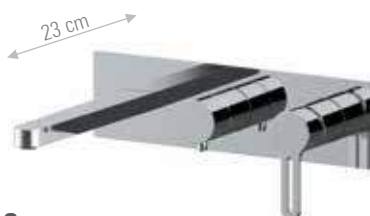
**SR700D3**

Set miscelatore a incasso a 3 vie per vasca/doccia su piastra unica rettangolare, include miscelatore monocomando, deviatore a 3 uscite, bocca a muro. Da completare con una seconda e una terza uscita acqua.
3-way built-in mixer set for bathtub/shower on single rectangular plate, including single-lever mixer, 3-way diverter, wall spout. To be completed with second and third water outlets.

CR	FIN A	FIN B
----	-------	-------

**SR700D3P**

Set miscelatore a incasso a 3 vie per vasca/doccia su 3 piastre tonde separate (piastre separate e parte a incasso unica), composto da: miscelatore monocomando con deviatore a 3 uscite, bocca a muro. Da completare con una seconda e una terza uscita acqua.
3-way built-in mixer set for bathtub/shower on 3 separate round plates (separate plates, one single built-in part), including: single-lever mixer with 3-way diverter, wall spout. To be completed with second and third water outlets.

CR	FIN A	FIN B
----	-------	-------

INCASSI DOCCIA - BUILT-IN MIXERS

□ □ □ 1 VIA - WAY □ □ □



SR602

Miscelatore incasso per doccia (articolo COMPLETO).
Built-in shower mixer (COMPLETE item).

□ CR □ FIN A □ FIN B

IN602C35

SOLO parti a incasso
Built-in parts ONLY.

□ CR □ FIN A □ FIN B

SR602EKIT

SOLO parti esterne.
Exposed parts ONLY.

□ CR □ FIN A □ FIN B

□ □ □ 2 VIE - 2-WAY □ □ □



SR612

Miscelatore incasso con deviatore per vasca/doccia (articolo COMPLETO).
Built-in bath/shower mixer with diverter (COMPLETE item).

□ CR □ FIN A □ FIN B

IN612C35

SOLO parti a incasso
Built-in parts ONLY.

□ CR □ FIN A □ FIN B

SR612EKIT

SOLO parti esterne.
Exposed parts ONLY.

□ CR □ FIN A □ FIN B



SR612D2

Miscelatore incasso con deviatore a 2 vie per vasca/doccia su piastra lusso ultrapiatta (articolo COMPLETO).
Built-in bath/shower mixer with 2-way diverter on luxury ultraslim plate (COMPLETE item).

□ CR □ FIN A □ FIN B



SR712D2

Set miscelatore a incasso a 2 vie per doccia su piastra unica rettangolare, include presa acqua con supporto, doccetta e flessibile 150 cm. Da completare con una 2° uscita.
2-way built-in shower mixer set on a single rectangular plate, including water connection with shower holder, hand shower and 150cm hose. To be completed with a 2nd water outlet.

□ CR □ FIN A □ FIN B



SR712D2P

Set miscelatore a incasso a 2 vie per doccia su 3 piastre tonde separate (parte a incasso unica), include: miscelatore e deviatore a 2 uscite, presa acqua con supporto, doccetta in ottone e flessibile 150 cm. Da completare con una 2° uscita.
2-way built-in shower mixer set on 3 separate round plates (single built-in part), including: mixer and 2-way diverter, water connection with holder, brass hand shower and 150cm flexible hose.. To be completed with a 2nd water outlet.

□ CR □ FIN A □ FIN B

□ □ □ 3 VIE - 3-WAY □ □ □

**SR612D3**

Miscelatore incasso con deviatore a 3 vie per vasca/doccia , 1 entrata e 3 uscite (articolo COMPLETO).

Built-in bath/shower mixer with 3-way diverter, 1 inlet and 3 outlets (COMPLETE item).

**SR712D3**

Set miscelatore a incasso a 3 vie per doccia su piastra unica rettangolare, include: miscelatore, deviatore a 3 uscite, presa acqua con supporto, doccetta in ottone e flessibile 150 cm.

Da completare con una 2° ed una 3° uscita.
3-way built-in shower mixer set on a single rectangular plate, including: single-lever mixer, 3-way diverter, water connection with shower holder, brass hand shower and 150cm flexible hose. To be completed with a 2nd and 3rd water outlet.

**SR712D3P**

Set miscelatore a incasso a 3 vie per doccia su 3 piastre tonde separate (parte a incasso unica), include: miscelatore e deviatore a 3 uscite, presa acqua con supporto, doccetta in ottone e flessibile 150cm. Da completare con una 2° ed una 3° uscita.

3-way built-in shower mixer set on 3 separate round plates (single built-in part), including: mixer and 3-way diverter, water connection with holder, brass hand-shower and 150cm flexible hose. To be completed with a 2nd and 3rd water outlet.



□ □ □ 4/5 VIE - 4/5-WAY □ □ □

**SR612D4**

Miscelatore incasso con deviatore a 4 vie per vasca/doccia , 1 entrata e 4 uscite (articolo COMPLETO).

Built-in bath/shower mixer with 4-way diverter, 1 inlet and 4 outlets (COMPLETE item).

**SR612D5**

Miscelatore incasso con deviatore a 5 vie per vasca/doccia , 1 entrata e 5 uscite (articolo COMPLETO).

Built-in bath/shower mixer with 5-way diverter, 1 inlet and 5 outlets (COMPLETE item).



COLONNE DOCCIA - SHOWER COLUMN



Set colonna vasca/doccia a 3 vie, composto da: miscelatore esterno vasca/doccia per colonna con deviatore SMART, colonna telescopica ad altezza regolabile, soffione ultra piatto in acciaio INOX lucidato a specchio, doccetta in ABS a 4 funzioni con pulsante per il cambio dell'intensità, flessibile 150cm.
3-way bath/shower column set, including: exposed bath/shower mixer for column with diverter SMART, height-adjustable telescopic column, ultra-flat shower head in mirror-polished stainless steel, 4-function abs hand shower with button for jets mode switching, 150cm flexible hose.

SR636DA3MP7820

Con soffione da Ø20 cm.
 With head shower Ø20 cm.

CR 15

SR636DA3MP7825

Con soffione da Ø25 cm.
 With head shower Ø25 cm.

CR 15

SR636DA3MP7830

Con soffione da Ø30 cm.
 With head shower Ø30 cm.

CR 15



SR636DA3MPEC20

Set colonna vasca/doccia a 3 vie, composto da: miscelatore esterno vasca/doccia per colonna con deviatore SMART, colonna telescopica ad altezza regolabile, soffione Ø 20 cm in abs cromato, doccetta in ABS a 4 funzioni con pulsante per il cambio dell'intensità, flessibile 150cm.
3-way bath/shower column set, including: exposed bath/shower mixer for column with diverter SMART, height-adjustable telescopic column, Ø 20cm abs shower head, 4-function abs hand shower with button for jets mode switching, 150cm flexible hose.

CR



Set colonna doccia, composto da: miscelatore esterno per colonna SMART, colonna telescopica ad altezza regolabile con deviatore, flessibile doccia 150cm, soffione ultra piatto in acciaio INOX lucidato a specchio, doccetta in ABS a 4 funzioni con pulsante per il cambio dell'intensità.
Shower column set, including: exposed mixer for column SMART, height-adjustable telescopic column with diverter, 150cm flexible hose, ultra-flat shower head in mirror-polished stainless steel, 4-function abs hand shower with button for jets mode switching.

SR636A3MP7820

Con soffione da Ø20 cm.
 With head shower Ø20 cm.

CR 15

SR636A3MP7825

Con soffione da Ø25 cm.
 With head shower Ø25 cm.

CR 15

SR636A3MP7830

Con soffione da Ø30 cm.
 With head shower Ø30 cm.

CR 15

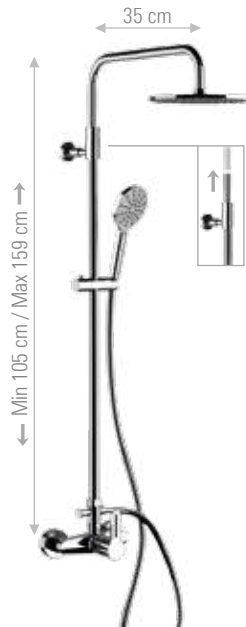

Set colonna doccia, composto da: miscelatore esterno per colonna SMART, colonna telescopica ad altezza regolabile con deviatore, flessibile doccia 150cm, soffione in abs, doccetta in ABS a 4 funzioni con pulsante per il cambio dell'intensità.
Shower column set, including: exposed mixer for column SMART, height-adjustable telescopic column with diverter, 150cm flexible hose, abs shower head, 4-function abs hand shower with button for jets mode switching, 150cm flexible hose.

SR636A3MP8420

Con soffione da Ø20 cm.
 With head shower Ø20 cm.

CR

SR636A3MP8425

Con soffione da Ø25 cm.
 With head shower Ø25 cm.

CR

SR636A3MP8430

Con soffione da Ø30 cm.
 With head shower Ø30 cm.

CR



SR614Z

Set doccia a incasso, composto da: miscelatore a incasso con deviatore SMART, asta saliscendi, attacco presa acqua a muro, braccio a muro in ottone 30cm, soffione Ø 20cm in abs, doccetta in abs a 3 funzioni, flessibile 150cm.
Built-in shower set, including: built-in mixer with diverter SMART, sliding rail, wall water connection, 30cm brass wall arm, Ø 20cm abs shower head, 3-function abs hand shower, 150cm flexible hose.

CR



SR615Z

Set doccia a incasso, composto da: miscelatore a incasso con deviatore SMART, attacco presa acqua a muro con supporto per doccetta, braccio a muro in ottone 30cm, soffione Ø 20cm in abs, doccetta in abs a 3 funzioni, flessibile 150cm.
Built-in shower set, including: built-in mixer with diverter SMART, wall water connection with hand shower holder, 30cm brass wall arm, Ø 20cm abs shower head, 3-function abs hand shower, 150cm flexible hose.

CR



Set doccia a incasso, composto da: miscelatore a incasso su piastra unica con deviatore a 2 vie, presa acqua con doccetta in ottone e flessibile 150 cm, braccio a muro in ottone 30cm, soffione in abs.
Built-in shower set, including: built-in mixer on 1 plate with 2-way diverter, water intake with brass hand-shower and 150cm hose, 30cm brass wall arm, abs shower head.



SR715ZD2L8420

Con soffione da Ø 20 cm.
 With head shower Ø 20 cm.

CR

SR715ZD2L8425

Con soffione da Ø 25 cm.
 With head shower Ø 25 cm.

CR

SR715ZD2L8430

Con soffione da Ø 30 cm.
 With head shower Ø 30 cm.

CR



SR614ZO

Set doccia a incasso, composto da: miscelatore a incasso con deviatore SMART, asta saliscendi in ottone, attacco presa acqua a muro, braccio a muro in ottone 30cm, soffione Ø 20 cm in ottone, doccetta in ottone a 1 funzione, flessibile 150cm.

Built-in shower set, including: built-in mixer with diverter SMART, brass sliding rail, wall water connection, 30cm brass wall arm, Ø 20cm brass shower head, 1-function brass hand shower, 150cm flexible hose.

CR FIN A FIN B



SR615ZO

Set doccia a incasso, composto da: miscelatore a incasso con deviatore SMART, attacco presa acqua a muro con supporto per doccetta, braccio a muro in ottone 30cm, soffione Ø 20 cm in ottone, doccetta in ottone a 1 funzione, flessibile 150cm.

Built-in shower set, including: built-in mixer with diverter SMART, wall water connection with hand shower holder, 30cm brass wall arm, Ø 20cm brass shower head, 1-function brass hand shower, 150cm flexible hose.

CR FIN A FIN B



Set doccia a incasso, composto da: miscelatore a incasso su 3 piastre tonde con deviatore a 2 vie, presa acqua con doccetta in ottone e flessibile 150 cm, braccio a muro in ottone 30cm, soffione in ottone.

NB: miscelatore, deviatore e doccetta hanno piastre esterne separate, ma un'unica parte a incasso.

Built-in shower set, including: built-in mixer on 3 round plates with 2-way diverter, water intake with brass hand-shower and 150cm hose, 30cm brass wall arm, brass shower head,

NB: mixer, diverter and hand-shower intake are on separate plates, but share one single built-in part.



SR715ZOD2PLCR

Con soffione da Ø20 cm.
With head shower Ø20 cm.

CR FIN A FIN B

SR715ZOD2PL9430CR

Con soffione da Ø30 cm.
With head shower Ø30 cm.

CR FIN A FIN B



SR618

Miscelatore lavello monoforo 90° con canna alta girevole.
Single-lever sink mixer 90° with high movable spout.

CR FIN A FIN B



SR618C

Miscelatore lavello monoforo 90° con canna girevole, modello corto.
Single-lever sink mixer 90° with movable spout, short type.

CR FIN A FIN B



SR633

Miscelatore monocomando lavello a muro, con leva frontale e bocca girevole.
Single-lever wall mounted sink mixer with frontal lever and movable spout.

CR FIN A FIN B



SR633B

Miscelatore lavello a muro, con leva frontale e canna alta girevole.
Single-lever wall mounted sink mixer with frontal lever and high movable spout.

CR FIN A FIN B



SR614B

Miscelatore monocomando per lavello, con bocca alta girevole.
Single-lever one-hole sink mixer, with high movable spout.

CR FIN A FIN B



SR614BC

Miscelatore monocomando per lavello, con canna corta girevole.
Single-lever one-hole sink mixer, with short movable spout.

CR FIN A FIN B



SR614T

Miscelatore lavello monoforo 45° con bocca alta girevole.
Single-lever sink mixer 45° with high movable spout.

CR FIN A FIN B



SR614TC

Miscelatore lavello monoforo 45° con bocca girevole, modello corto.
Single-lever sink mixer 45° with movable spout short type.

CR FIN A FIN B

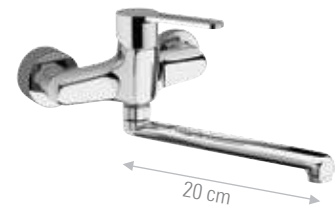

SR609T

Miscelatore lavello a muro con canna girevole.
Wall-mounted single-lever sink mixer with movable spout.

CR FIN A FIN B



SR609S

Miscelatore lavello a muro con bocca ad "S" girevole.
Wall-mounted single-lever sink mixer with "S" movable spout.

CR FIN A FIN B



SR614R

Miscelatore monocomando lavello per installazione sottofinestra, con bocca alta girevole e reclinabile, tipo lusso.
Single-lever sink mixer for under window installation, with high swivel reclining spout, luxury type.

CR FIN A FIN B

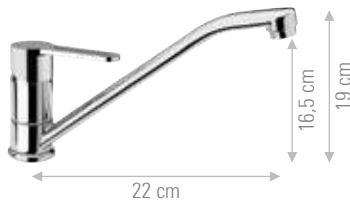

SR629

Monocomando lavello con canna fusa girevole.
Single-lever sink mixer with swiveling casted spout.

CR FIN A FIN B



SR617

Miscelatore monocomando lavello con bocca alta quadrata ad "U" girevole.
Single-lever sink mixer with "U" squared high movable spout.

CR FIN A FIN B

GOURMET

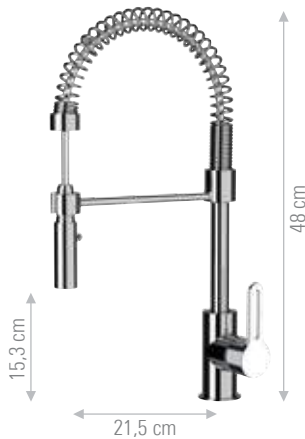

SR689

Miscelatore monocomando lavello a molla con doccetta estraibile ed orientabile a due funzioni e cartuccia Ø 35.
Spring single-lever sink mixer with pull-out and swivelling 2-functions hand shower and Ø 35 mm cartridge.

CR

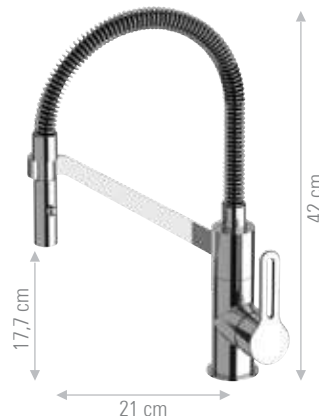

SR233

Miscelatore lavello monocomando con flessibile nero rivestito con molla "fine design" girevole 360°, con doccetta estraibile ed orientabile a due funzioni e cartuccia Ø 35.
Single-lever mixer with black flexible hose coated with "fine design" spring, 360° movable, with pull-out and swivelling 2-functions hand shower and Ø 35 mm cartridge.

CR

ACQUA DEPURATA
 PURIFIED WATER



SR679DW

Miscelatore lavello a tre vie di ingresso con bocca girevole e due vie d'uscita completamente indipendenti, con selezione acqua potabile tramite la leva.
Three ways inlet single lever sink mixer, with movable spout and two fully independent outlets, with selection for drinking water directly from the lever.

CR FIN A FIN B



SR605



SR600H



A310434I

SRKIT1

Set composto da: miscelatore per lavabo con scarico, asta saliscendi, miscelatore vasca esterno, doccia in abs a 3 funzioni, flessibile 150cm.

Set including: basin mixer with pop-up waste, sliding rail, exposed bath mixer, 3-function abs hand shower, 150cm flexible hose.

CR



SR605



SR604



SR600H



A310434I

SRKIT4P1

Set composto da: miscelatore per lavabo con scarico, asta saliscendi, miscelatore vasca esterno, miscelatore bidet con scarico, doccia in abs a 3 funzioni, flessibile 150cm.

Set including: basin mixer with pop-up waste, sliding rail, exposed bath mixer, bidet mixer with pop-up waste, 3-function abs hand shower, 150cm flexible hose.

CR



PROGRAMMA GREEN GREEN PROGRAM

Le collezioni di rubinetteria del programma GREEN di Daniel Rubinetterie includono una serie di tecnologie e funzioni dedicate al risparmio idrico ed energetico.

Grazie alla combinazione di queste tecnologie è possibile generare un'effettiva riduzione dei consumi con un impatto positivo sia economico che ambientale.

The faucet collections of the GREEN program by Daniel Rubinetterie include a series of technologies and features dedicated to saving water and energy.

Thanks to the combination of these technologies, it is possible to generate an effective reduction in consumption with a positive economic and environmental impact.

STANDARD



CARTUCCIA ENERGY SAVING
ENERGY SAVING CARTRIDGE



AERATORE WATER SAVING
WATER SAVING AERATOR

Funzioni di risparmio disponibili di serie sui miscelatori delle collezioni di rubinetteria GREEN.

Saving features available as standard on the mixers of GREEN faucet collections.

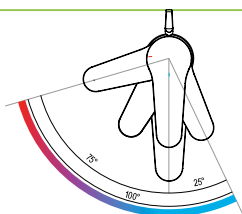

COD. A803
STANDARD
6 L/min



OPTIONS:

3 L/MIN
4 L/MIN
8 L/MIN

OPTIONAL



ANELLO ANTISCALDING
ANTISCALDING RING



LEVA WATER SAVING DYNAMIC
WATER SAVING DYNAMIC LEVER

Funzioni di risparmio aggiuntive disponibili su richiesta. Combinabili con le tecnologie standard.

Additional savings features available on request. Can be combined with standard technologies.

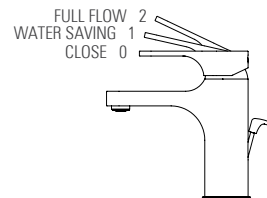

Cartuccia Made in Italy tecnologica realizzata con plastica alimentare eco friendly
Made in Italy eco friendly technologic cartridge

Aeratore a risparmio idrico
Water saving aerator

Flessibili Made in Italy, in gomma alimentare epdm, raccordati con macchine automatiche
Made in Italy flexible hoses, with epdm limentary rubber, made by automatic assembling machines



CARTUCCIA ENERGY SAVING:

PER LIMITARE GLI UTILIZZI INVOLONTARI DI ACQUA CALDA.

Quando la leva del miscelatore è in posizione centrale, allineata alla bocca del rubinetto, la cartuccia ENERGY SAVING prevede l'apertura in sola acqua fredda. Questo evita le richieste involontarie di acqua calda e la conseguente attivazione accidentale della caldaia, garantendo così un risparmio energetico. Per utilizzare l'acqua calda è sufficiente ruotare la leva verso sinistra.

AERATORE WATER SAVING:

PER LIMITARE LA PORTATA.

Aeratore a risparmio idrico per limitare la portata totale dell'acqua. Limitazione di portata standard a 6 litri al minuto sui miscelatori delle collezioni GREEN (disponibili su richiesta le versioni 8, 4 o 3 litri al minuto).

ANELLO ANTISCALDING:

PER LIMITARE LA TEMPERATURA MASSIMA DELL'ACQUA CALDA.

Una speciale ghiera posizionata sulla cartuccia, previa regolazione dell'utente al momento dell'installazione, limita la temperatura massima erogabile, impedendo la completa rotazione della maniglia verso l'acqua calda. L'impostazione "di fabbrica" della ghiera è in posizione neutra. (Funzione disponibile su richiesta).

LEVA WATER SAVING DYNAMIC:

PER IL CONTROLLO DINAMICO DELLA PORTATA D'ACQUA EROGATA.

Il controllo dinamico dell'erogazione dell'acqua avviene ad ogni apertura tramite una leggera resistenza della leva intorno al 50% della sua portata massima.

Questo si traduce in un invito per l'utente a non aprire completamente il flusso dell'acqua se non strettamente necessario, riducendo gli sprechi d'acqua quotidiani. L'erogazione completa fino al 100% del flusso rimane comunque sempre possibile superando questa leggera resistenza. (Funzione disponibile su richiesta).

ENERGY SAVING CARTRIDGE:

TO LIMIT THE ACCIDENTAL USE OF HOT WATER.

When the mixer lever is in the central position, aligned with the tap spout, the ENERGY SAVING cartridge opens in cold water only. This avoids the involuntary requests for hot water and the consequent accidental activation of the boiler, thus guaranteeing energy savings. To use hot water, simply turn the lever to the left.

WATER SAVING AERATOR:

TO REDUCE FLOW.

Water saving aerator to limit the total water flow rate. Standard flow rate limitation to 6 liters per minute on GREEN collections mixers (8, 4 or 3 liters per minute also available on request).

ANTISCALDING RING:

TO LIMIT THE MAXIMUM HOT WATER TEMPERATURE.

A special ring nut positioned above the cartridge, subject to user adjustment at the time of installation, limits the maximum deliverable temperature, preventing the complete rotation of the lever towards hot water. The factory setting of the ring is in a neutral position. (Feature available upon request).

WATER SAVING DYNAMIC LEVER:

FOR A DYNAMIC CONTROL OF THE DISPENSED WATER FLOW.

The dynamic control of the water supply occurs at each opening through a slight resistance of the lever around 50% of its maximum flow rate.

This becomes a reminder to the user not to fully open the water flow unless absolutely necessary, reducing daily water waste.

Full delivery up to 100% of the flow is still always possible by overcoming this slight resistance. (Function available upon request).

STANDARD



CARTUCCIA ENERGY SAVING
ENERGY SAVING CARTRIDGE



AERATORE WATER SAVING
WATER SAVING AERATOR

OPTIONAL

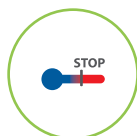

ANELLO ANTISCALDING
ANTISCALDING RING



LEVA WATER SAVING DYNAMIC
WATER SAVING DYNAMIC LEVER

+A

+S

+SA

NOTA PER LE FUNZIONI OPZIONALI:

Per richiedere la funzione ANTISCALDING, aggiungere la lettera **A** alla fine del codice prodotto (es. OME605LT6A).

Per richiedere la funzione WATER SAVING DYNAMIC aggiungere la lettera **S** alla fine del codice prodotto (es. OME605LT6S).

Per richiedere sia la funzione ANTISCALDING che la funzione WATER SAVING DYNAMIC aggiungere le lettere **SA** alla fine del codice prodotto (es. OME605LT6SA).

NOTE FOR OPTIONAL FEATURES:

To request the ANTISCALDING feature, add the letter **A** at the end of the item code (e.g. OME605LT6A).

To request the WATER SAVING DYNAMIC feature add the letter **S** at the end of the item code (e.g. OME605LT6S).

To request both the ANTISCALDING and the WATER SAVING DYNAMIC features add the letters **SA** at the end of the item code (e.g. OME605LT6SA).

OMEGA GREEN

Le linee dolci e tondeggianti della collezione OMEGA sposano il programma GREEN, inserendo nella fornitura standard la cartuccia ENERGY SAVING per limitare le richieste accidentali di acqua calda quando la leva è in posizione parallela alla bocca del miscelatore.

La serie OMEGA GREEN è inoltre dotata di aeratore a risparmio idrico con limitazione di portata a 6 litri al minuto. La collezione può essere integrata, su specifica richiesta, con le altre opzioni GREEN a catalogo (ANTISCALDING e WATER SAVING DYNAMIC)

The soft and rounded lines of the OMEGA collection combine the GREEN program, including in the standard furniture the ENERGY SAVING cartridge to limit accidental requests for hot water when the lever is parallel to the mixer's mouth. OMEGA GREEN series is also equipped with a water-saving aerator with a flow limitation of 6 liters per minute. Series can be integrated, on demand, with the other GREEN options on the catalog (ANTISCALDING and WATER SAVING DYNAMIC).

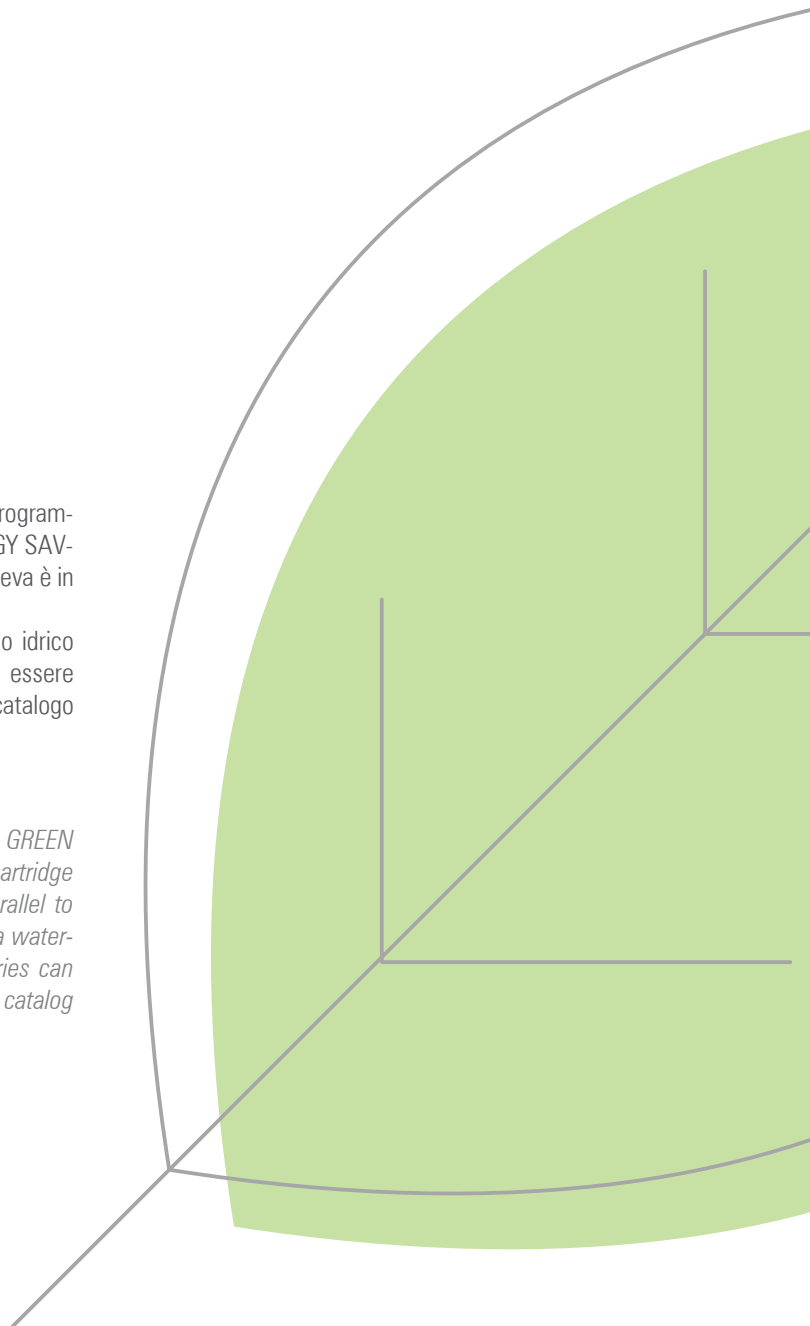



OMEGA GREEN

OME606LT6

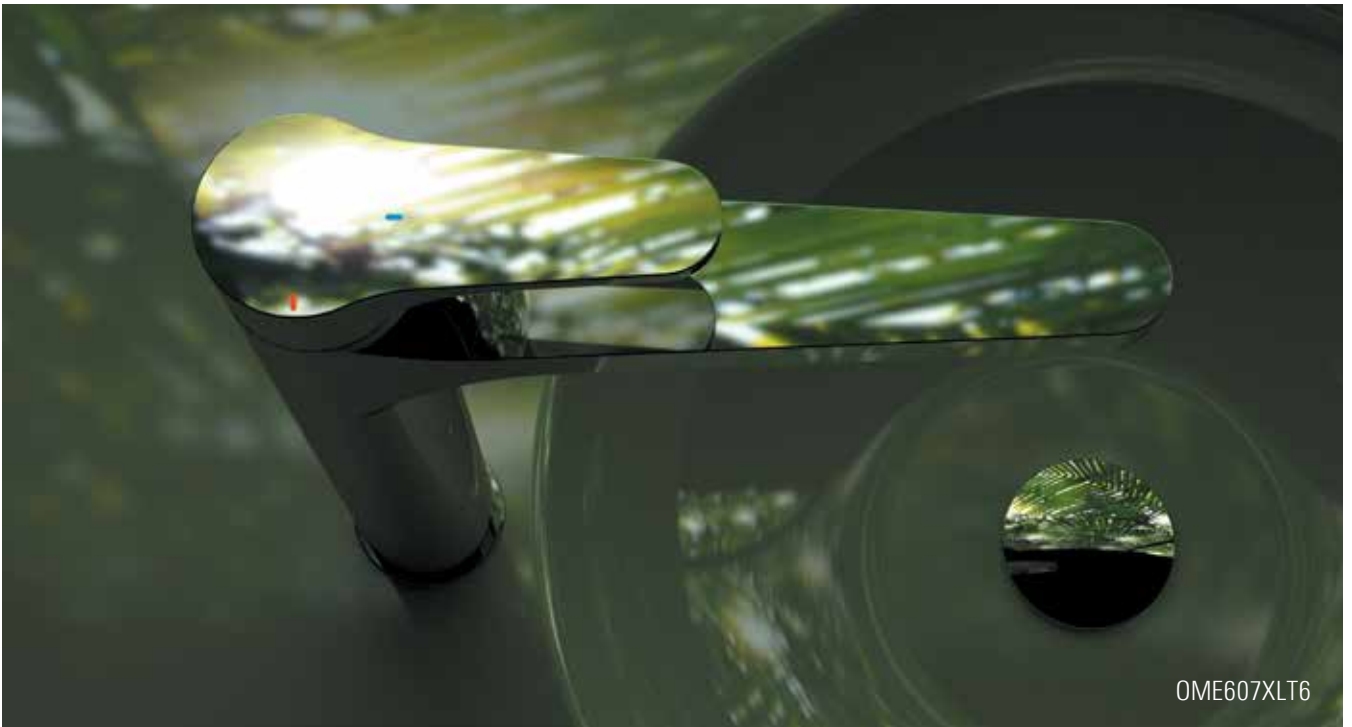

OME607XLT6



OME604BLT6

CARATTERISTICHE TECNICHE:

La serie è dotata di cartuccia a dischi ceramici, Ø 35 mm, prodotta da S.T.S.R. – Studio Tecnico Sviluppo e Ricerche - www.stsr.it

TECHNICAL FEATURES:

The series is equipped with ceramic cartridge, Ø 35 mm, produced by S.T.S.R. - Research Development Technical Office - www.stsr.it



OME606LT6



OME632LT6

SMART GREEN

OMEGA GREEN

SMART

OMEGA

REFLEX



LAVABI - WASHBASIN MIXERS



OME605LT6

Monocomando lavabo, con scarico.
Single-lever basin mixer, with pop-up waste.



CR FIN A FIN B



OME607LT6

Monocomando lavabo alto, con scarico.
High single-lever basin mixer, with pop-up waste.



CR FIN A FIN B



OME607XLT6

Monocomando lavabo XL, con scarico click-clack.
XL basin mixer, with click-clack waste.



CR FIN A FIN B

OME606NLT6

Monocomando lavabo, senza scarico e senza foro sul corpo.
Single-lever basin mixer, without waste and without body hole.



CR FIN A FIN B

OME607BNLT6

Monocomando lavabo alto, senza scarico e senza foro sul corpo.
High single-lever basin mixer, without waste and without body hole.



CR FIN A FIN B

OME607XBLT6

Monocomando lavabo XL, senza scarico e senza foro sul corpo.
XL basin mixer, without waste and without body hole.

CR FIN A FIN B

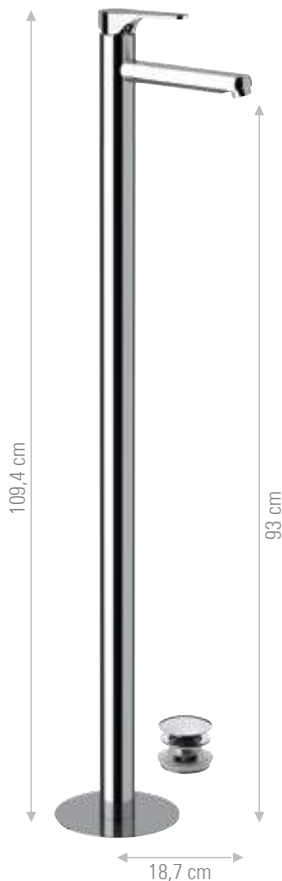

OME688LT6

Miscelatore monocomando lavabo da pavimento con click-clack e troppo pieno.
Single-lever mixer floor mounting with click-clack and overflow.



CR FIN A FIN B

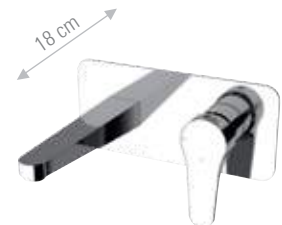

OME632LT6

Miscelatore monocomando a incasso per lavabo, con piastra rettangolare.
Single-lever built-in basin mixer, with rectangular wall flange.



CR FIN A FIN B

BIDET



OME604LT6

Miscelatore bidet, con scarico.
Bidet mixer, with pop-up waste.



CR FIN A FIN B



OME604BNLT6

Miscelatore bidet, senza scarico.
Bidet mixer, without pop-up waste.



CR FIN A FIN B



OME645LT6

Miscelatore incasso per shut-off con doccetta shut-off, supporto doccia, presa acqua.
Built-in shut-off mixer set shut-off, shower holder, water punch.



CR FIN A FIN B

SOFFIONI - SHOWER HEADS



Soffione doccia ultra piatto in acciaio inox lucidato a specchio, con limitatore di portata a 8 litri/minuto, con scatola.
Ultra slim stainless steel mirror polished shower head, 8 lt/min flow limiter. Boxed item.

A579CM20LT8

20x20 cm CR

A579CM25LT8

25x25 cm CR

A579CM30LT8

30x30 cm CR



Soffione doccia ultra piatto in acciaio inox lucidato a specchio, con limitatore di portata a 8 litri/minuto, con scatola.
Ultra slim stainless steel mirror polished shower head, 8 lt/min flow limiter. Boxed item.

A578CM20LT8

Ø 20 cm CR

A578CM25LT8

Ø 25 cm CR

A578CM30LT8

Ø 30 cm CR



Soffione a pioggia minimale, in abs cromato Ø 20 cm, con getti in silicone anticalcare con limitatore di portata a 8 litri/minuto, con scatola.
C.p. ABS Minimal shower head, rain jet, Ø 20 cm, with anti-limestone silicon jets, 8 lt/min flow limiter. Boxed item.

A585EC20LT8

CR



Soffione con disco anticalcare a snodo Ø 7 cm con limitatore di portata a 8 litri/minuto, con scatola.
Showerhead with anti-limestone jet with ball joint, Ø 7 cm, 8 lt/min flow limiter. Boxed item.

A560LT8

CR

CUCINA - KITCHEN

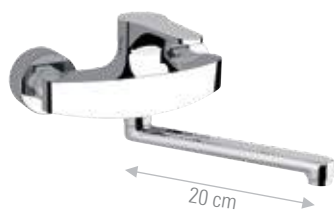

OME609TLT6



Miscelatore lavello a muro con canna girevole.
Wall-mounted single-lever sink mixer with movable spout.

CR FIN A FIN B



OME609SLT6



Miscelatore lavello a muro con bocca ad "S" girevole.
Wall-mounted single-lever sink mixer with "S" movable spout.

CR FIN A FIN B



OME614RLT6



Miscelatore monocomando lavello per installazione sottofinestra, con bocca alta girevole e reclinabile, tipo lusso.
Single-lever sink mixer for under window installation, with high swivel reclining spout, luxury type.

CR FIN A FIN B



OME614TLT6



Miscelatore lavello monoforo 45° con bocca alta girevole.
Single-lever sink mixer 45° with high movable spout.

CR FIN A FIN B



OME614CLT6



Miscelatore lavello monoforo 45° con canna fusa corta girevole.
Single-lever sink mixer 45° with short movable casted spout.

CR FIN A FIN B



OME614TCLT6



Miscelatore lavello monoforo 45° con canna corta girevole.
Single-lever sink mixer 45° with short movable spout.

CR FIN A FIN B



OME618LT6



Miscelatore lavello monoforo 90° con canna alta girevole.
Single-lever sink mixer 90° with high movable spout.

CR FIN A FIN B



OME618CLT6



Miscelatore lavello monoforo 90° con canna alta girevole, modello corto.
Single-lever sink mixer 90° with high movable spout, short type.

CR FIN A FIN B



OME629LT6



Monocomando lavello con canna girevole.
Single-lever sink mixer with swiveling spout.

CR FIN A FIN B



OME617LT6



Miscelatore lavello monoforo 45° con canna alta "U" girevole.
Single-lever sink mixer 45° with high movable "U" spout.

CR FIN A FIN B



OME624LT6



Miscelatore lavabo/vasca con canna fusa lunga e con deviatore con kit doccia.
Wall basin/bath single lever mixer with long casted spout, and diverter with shower kit.

CR FIN A FIN B



OME624HLT6



Miscelatore lavabo/vasca con canna fusa lunga, e con deviatore senza kit doccia.
Wall basin/bath single lever mixer with long casted spout 30 cm, and diverter without shower kit.

CR FIN A FIN B



DOCCETTA IN FINITURA FINISH HAND SHOWER

Il modello della doccetta inclusa nel kit può variare in base alla finitura scelta.
The model of the hand shower included in the kit may vary according to the chosen finish.

CR	FIN A						FIN B				
CR	15	14	NP	63	OIL	64	DO	DP	FZ	CF	RP
Doccetta abs, 1 funzioni. ABS hand shower, 1-function.	Doccetta minimale in ottone, 1 funzioni. Minimal brass hand shower, 1-function.										

SMART GREEN

SMART GREEN combina la sua semplicità di design con il PROGRAMMA GREEN, inserendo nella fornitura standard la cartuccia ENERGY SAVING per limitare le richieste accidentali di acqua calda quando la leva è in posizione parallela alla bocca del miscelatore.

La serie SMART GREEN è inoltre dotata di aeratore a risparmio idrico con limitazione di portata a 6 litri al minuto. La collezione può essere integrata, su specifica richiesta, con le altre opzioni GREEN a catalogo (ANTISCALDING e WATER SAVING DYNAMIC)

SMART GREEN combines its simplicity of design with the GREEN PROGRAM, including in the standard furniture the ENERGY SAVING cartridge to limit accidental requests for hot water when the lever is parallel to the mixer's mouth. SMART GREEN collection is also equipped with a water-saving aerator with a flow limitation of 8 liters per minute. The series can be integrated, on demand, with the other GREEN options on the catalog (ANTISCALDING and WATER SAVING DYNAMIC).

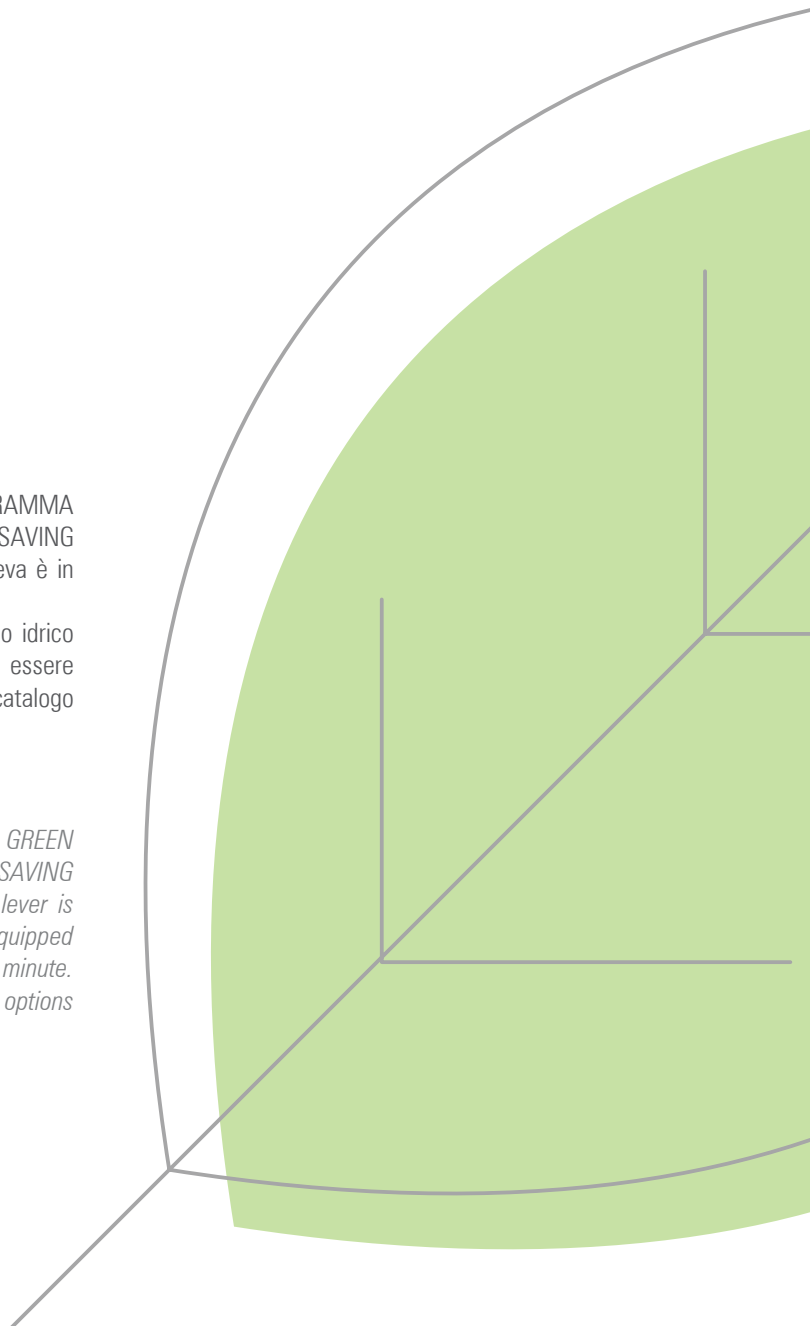



SMART GREEN

SRE606LT6

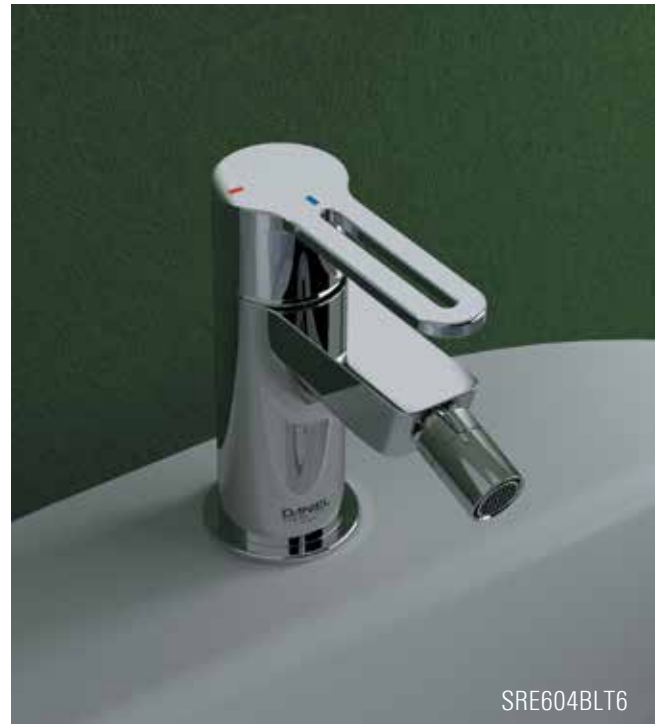

CARATTERISTICHE TECNICHE:

La serie è dotata di cartuccia a dischi ceramici, Ø 35 mm, prodotta da S.T.S.R. – Studio Tecnico Sviluppo e Ricerche - www.stsr.it

TECHNICAL FEATURES:

The series is equipped with ceramic cartridge, Ø 35 mm, produced by S.T.S.R. - Research Development Technical Office - www.stsr.it



SRE632LT6

SMART GREEN

OMEGA GREEN

SMART

OMEGA

REFLEX

LAVABI - WASHBASIN MIXERS



SRE605LT6

Monocomando lavabo, con scarico.
Single-lever basin mixer, with pop-up waste.



CR FIN A FIN B



SRE607LT6

Monocomando lavabo XL, con scarico click-clack.
XL basin mixer, with click-clack waste.



CR FIN A FIN B

SRE605ALT6

Monocomando lavabo, scon scarico in plastica.
Single-lever basin mixer, with plastic waste.



CR FIN A FIN B

SRE607BLT6

Monocomando lavabo XL, senza scarico.
XL basin mixer, without waste.



CR FIN A FIN B



SRE606NLT6

Monocomando lavabo, senza scarico e senza foro sul corpo.
High single-lever basin mixer, without waste and without body hole.



CR FIN A FIN B



SRE632LT6

Miscelatore monocomando a incasso per lavabo, con piastra rettangolare.
Single-lever built-in basin mixer, with rectangular wall flange.



CR FIN A FIN B

BIDET - BIDET MIXERS



SRE604LT6

Miscelatore bidet, con scarico.
Bidet mixer, with pop-up waste.



CR FIN A FIN B

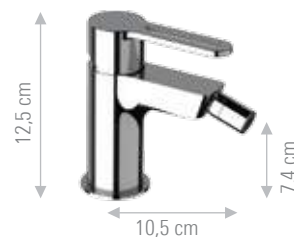

SRE604BNLT6

Miscelatore bidet, senza scarico e senza foro sul corpo.
Bidet mixer, without waste and without body hole.



CR FIN A FIN B



SRE645LT6

Miscelatore incasso per shut-off con doccetta shut-off, supporto doccia, presa acqua.
Built-in shut-off mixer set with shut-off, shower holder water punch.



CR FIN A FIN B

SRE604ALT6

Miscelatore bidet, con scarico in plastica.
Bidet mixer, with plastic waste.



CR FIN A FIN B

SOFFIONI - SHOWER HEADS



Soffione doccia ultra piatto in acciaio inox lucidato a specchio, con limitatore di portata a 8 litri/minuto, con scatola.
Ultra slim stainless steel mirror polished shower head, 8 lt/min flow limiter. Boxed item.

A579CM20LT8 20x20 cm

A579CM25LT8 25x25 cm

A579CM30LT8 30x30 cm



Soffione doccia ultra piatto in acciaio inox lucidato a specchio, con limitatore di portata a 8 litri/minuto, con scatola.
Ultra slim stainless steel mirror polished shower head, 8 lt/min flow limiter. Boxed item.

A578CM20LT8 Ø 20 cm

A578CM25LT8 Ø 25 cm

A578CM30LT8 Ø 30 cm



Soffione a pioggia minimale, in abs cromato Ø 20 cm, con getti in silicone anticalcare con limitatore di portata a 8 litri/minuto, con scatola.
C.p. ABS Minimal shower head, rain jet, Ø 20 cm, with anti-limestone silicon jets, 8 lt/min flow limiter. Boxed item.

A585EC20LT8



Soffione con disco anticalcare a snodo Ø 7 cm con limitatore di portata a 8 litri/minuto, con scatola.
Showerhead with anti-limestone jet with ball joint, Ø 7 cm, 8 lt/min flow limiter. Boxed item.

A560LT8

CUCINA - KITCHEN



SRE618LT6

Miscelatore lavello monoforo 90° con canna alta girevole.
Single-lever sink mixer 90° with high movable spout.



SRE618CLT6

Miscelatore lavello monoforo 90° con canna alta girevole, modello corto.
Single-lever sink mixer 90° with high movable spout, short type.



SRE614RLT6

Miscelatore monocomando lavello per installazione sottofinestra, con bocca alta girevole e reclinabile, tipo lusso.
Single-lever sink mixer for under window installation, with high swivel reclining spout, luxury type.



SRE614TLT6

Miscelatore lavello monoforo 45° con bocca alta girevole.
Single-lever sink mixer 45° with high movable spout.



CLASSICA



BROOKLYN

pag 288

REVIVAL

pag 300

RETRÒ

pag 312

CRYSTAL RETRÒ

pag 322

BROOKLYN

BROOKLYN è una collezione di miscelatori monocomando dallo stile vintage, un fascino intramontabile che si esprime attraverso forme tondeggianti e intarsi decorativi.

BROOKLYN is a collection of single-lever mixers with a vintage style, a timeless charm expressed by rounded shapes and decorative inlays.





BY606N

CARATTERISTICHE TECNICHE:

La serie è dotata di vitone ceramico,
prodotto da S.T.S.R. Studio Tecnico Sviluppo e Ricerche
www.stsr.it

TECHNICAL FEATURES:

The series is equipped with ceramic headvalves,
produced by S.T.S.R. - Research Development Technical Office
www.stsr.it





BY60715

15
NERO OPACO
MATT BLACK



DO
ORO LUCIDO
SHINY GOLD

BY632PDO



63
VECCHIO OTTONE
OLD BRASS

BY632P63

LAVABI - WASHBASIN MIXERS



BY605

Monocomando lavabo con scarico.
Single lever washbasin mixer with pop-up waste.

CR FIN A FIN B



BY606N

Monocomando lavabo, senza scarico e senza foro sul corpo.
Single-lever basin mixer, without waste and without body hole.

CR FIN A FIN B



BY607

Monocomando lavabo XL., con scarico click-clak.
XL basin mixer, with pop-up waste.

CR FIN A FIN B



BY607B

Monocomando lavabo alto, senza scarico.
High basin mixer, without waste.

CR FIN A FIN B

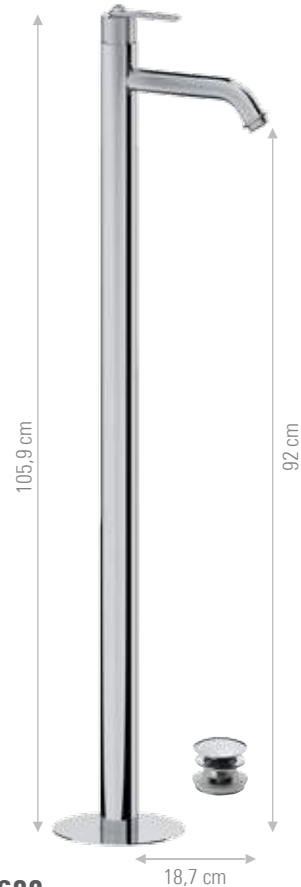

BY688

Miscelatore monocomando lavabo da pavimento con click-clack e troppo pieno.
Single-lever mixer floor mounting with click-clack and overflow.

CR FIN A FIN B



BY632P

Miscelatore monocomando da incasso per lavabo, su doppia piastra.
Built-in single-lever basin mixer with two separate plates.

CR FIN A FIN B

BIDET - BIDET MIXERS



BY604

Miscelatore monocomando bidet con scarico.
Single lever bidet mixer with pop-up waste.

CR FIN A FIN B



BY604BN

Monocomando lavabo, senza scarico e senza foro sul corpo.
Single-lever basin mixer, without waste and without body hole.

CR FIN A FIN B



BY645DCZ

Miscelatore incasso per shut-off con supporto doccia/presa acqua integrato, attacco conico da 1/2", con doccetta shut-off e flessibile cm 120.
Built-in shower mixer with integrated shower holder/water punch on flange, with 1/2 connection, with shut-off and flexible hose cm 120.

CR FIN A FIN B

MISCELATORI VASCA E DOCCIA - SHOWER AND BATH MIXERS



BY610

Miscelatore vasca esterno, con doccetta in ottone 1 funzione, flessibile 150 cm.
Exposed bath mixer, with 1-function brass hand shower, flexible 150 cm.

CR FIN A FIN B



BY631A

Monocomando doccia esterno, con doccetta in ottone 1 funzione, flessibile 150 cm.
Exposed shower mixer, with 1-function brass hand shower, flexible 150 cm.

CR FIN A FIN B



BY600H

Miscelatore vasca con deviatore integrato, senza kit doccia.
Wall mounted bath mixer with integrated diverter, without shower kit.

CR FIN A FIN B



BY631

Miscelatore doccia con leva frontale, senza kit doccia.
Exposed shower mixer with frontal lever, without shower kit.

CR FIN A FIN B

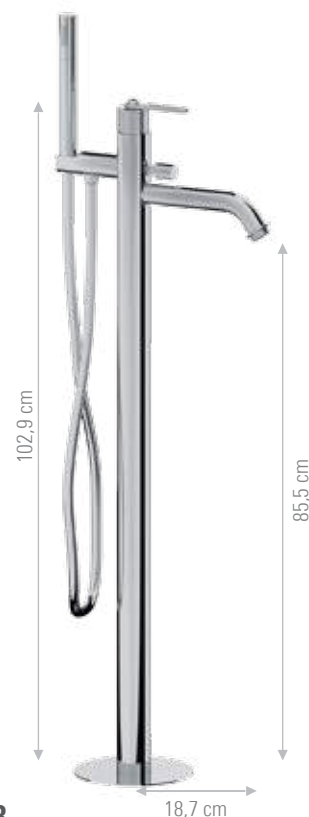

BY678

Miscelatore vasca da pavimento con deviatore e kit doccia.
Free standing bath mixer floor mounting with diverter and shower kit.

CR FIN A FIN B

□ □ □ 2 VIE - 2-WAY □ □ □



BY700D2

Set miscelatore a incasso a 2 vie per vasca/doccia su piastra unica rettangolare, include miscelatore monocomando, deviatore a 2 uscite, bocca a muro. Da completare con una seconda uscita acqua.
2-way built-in mixer set for bathtub / shower on single rectangular plate, including single-lever mixer, 2-way diverter, wall spout. To be completed with a second water outlet.

CR FIN A FIN B



BY700D2P

Set miscelatore a incasso a 2 vie per vasca/doccia su 3 piastre tonde separate (piastre separate e incasso unico), include: miscelatore monocomando, deviatore a 2 uscite, bocca a muro. Da completare con una seconda uscita.
2-way built-in mixer set for bathtub / shower on 3 separate round plates (separate plates, one single built-in part), including: single-lever mixer, 2-way diverter, wall spout. To be completed with a second water outlet.

CR FIN A FIN B



BY710D2

Set a incasso a 2 vie per vasca, include: miscelatore monocomando, deviatore a 2 uscite e bocca a muro su piastra unica rettangolare; set doccia su piastra quadrata con presa acqua, supporto integrato, doccetta in ottone e flessibile 150cm.
2-way built-in set for bathtub, including: single-lever mixer, 2-way diverter and wall spout on a single rectangular plate; shower set on square plate with water connection, holder, brass handshower and 150cm flexible hose.

CR FIN A FIN B



BY710D2P

Set a incasso a 2 vie per vasca su piastre tonde separate (3 piastre separate e incasso unico), include: miscelatore monocomando con deviatore a 2 uscite, bocca a muro; set doccia su piastra tonda con presa acqua, supporto, doccetta e flessibile 150cm.
2-way built-in set for bathtub on separate round plates (3 separate plates, one single built-in part), including: single-lever mixer, 2-way diverter, wall spout; Shower set on round plate with water connection, holder, hand shower and 150cm flexible hose.

CR FIN A FIN B

□ □ □ 3 VIE - 3-WAY □ □ □



BY700D3

Set miscelatore a incasso a 3 vie per vasca/doccia su piastra unica rettangolare, include miscelatore monocomando, deviatore a 3 uscite, bocca a muro. Da completare con una seconda e una terza uscita acqua.
3-way built-in mixer set for bathtub/shower on single rectangular plate, including single-lever mixer, 3-way diverter, wall spout. To be completed with second and third water outlets.

CR FIN A FIN B



BY700D3P

Set miscelatore a incasso a 3 vie per vasca/doccia su 3 piastre tonde separate (piastre separate e parte a incasso unica), composto da: miscelatore monocomando con deviatore a 3 uscite, bocca a muro. Da completare con una seconda e una terza uscita acqua.
3-way built-in mixer set for bathtub/shower on 3 separate round plates (separate plates, one single built-in part), including: single-lever mixer with 3-way diverter, wall spout. To be completed with second and third water outlets.

CR FIN A FIN B

INCASSI DOCCIA - BUILT-IN MIXERS

□ □ □ 1 VIA - 1-WAY □ □ □



BY602G

Miscelatore incasso per doccia (articolo COMPLETO).
Built-in shower mixer (COMPLETE item).

CR FIN A FIN B

IN602C35

SOLO parti a incasso
Built-in parts ONLY.

CR FIN A FIN B

BY602GEKIT

SOLO parti esterne.
Exposed parts ONLY.

CR FIN A FIN B



BY612G

Miscelatore incasso con deviatore per vasca/doccia (articolo COMPLETO).
Built-in bath/shower mixer with diverter (COMPLETE item).

CR FIN A FIN B

IN612C35

SOLO parti a incasso
Built-in parts ONLY.

CR FIN A FIN B

BY612GEKIT

SOLO parti esterne.
Exposed parts ONLY.

CR FIN A FIN B

□ □ □ 2 VIE - 2-WAY □ □ □

□ □ □ 3 VIE - 3-WAY □ □ □



BY712D2

Set miscelatore a incasso a 2 vie per doccia su piastra unica rettangolare, include presa acqua con supporto, doccetta e flessibile 150 cm. Da completare con una 2° uscita.
2-way built-in shower mixer set on a single rectangular plate, including water connection with shower holder, hand shower and 150cm hose. To be completed with a 2nd water outlet.

CR FIN A FIN B



BY712D2P

Set miscelatore a incasso a 2 vie per doccia su 3 piastre tonde separate (parte a incasso unica), include: miscelatore e deviatore a 2 uscite, presa acqua con supporto, doccetta in ottone e flessibile 150 cm. Da completare con una 2° uscita.
2-way built-in shower mixer set on 3 separate round plates (single built-in part), including: mixer and 2-way diverter, water connection with holder, brass hand shower and 150cm flexible hose. To be completed with a 2nd water outlet.

CR FIN A FIN B



BY712D3

Set miscelatore a incasso a 3 vie per doccia su piastra unica rettangolare, include: miscelatore, deviatore a 3 uscite, presa acqua con supporto, doccetta in ottone e flessibile 150 cm. Da completare con una 2° ed una 3° uscita.
3-way built-in shower mixer set on a single rectangular plate, including: single-lever mixer, 3-way diverter, water connection with shower holder, brass hand shower and 150cm flexible hose. To be completed with a 2nd and 3rd water outlet.

CR FIN A FIN B



BY712D3P

Set miscelatore a incasso a 3 vie per doccia su 3 piastre tonde separate (parte a incasso unica), include: miscelatore e deviatore a 3 uscite, presa acqua con supporto, doccetta in ottone e flessibile 150cm. Da completare con una 2° ed una 3° uscita.
3-way built-in shower mixer set on 3 separate round plates (single built-in part), including: mixer and 3-way diverter, water connection with holder, brass hand-shower and 150cm flexible hose. To be completed with a 2nd and 3rd water outlet.

CR FIN A FIN B

— KIT WELLNESS - WELLNESS KIT —



Set doccia a incasso, composto da: miscelatore a incasso su 3 piastre tonde con deviatore a 3 vie, presa acqua con doccetta in ottone e flessibile 150 cm, braccio a muro in ottone 30cm con rosetta BROOKLYN, soffione a pioggia tondo, altezza 3cm, acciaio inox lucidato a specchio, bocca rotonda a incasso con getto a cascata in acciaio inox lucidato a specchio.

NB: miscelatore, deviatore e doccetta hanno piastre esterne separate, ma un'unica parte a incasso.

Built-in shower set, including: built-in mixer on 3 round plates with 3-way diverter, water intake with brass hand-shower and 150cm hose, 30cm brass wall arm with BROOKLYN flange, round shower head, height 3cm, mirror polished stainless steel, round built-in spout with cascade jet in mirror-polished stainless steel.

NB: mixer, diverter and hand-shower intake are on separate plates, but share one single built-in part.

BY715ZD3PXT8322

Con soffione da Ø22 cm.
With head shower Ø22 cm.

— CR — — 15 —

BY715ZD3PXT8332

Con soffione da Ø32 cm.
With head shower Ø32 cm.

— CR — — 15 —



BY715ZD3PXT8H32215



Set doccia a incasso, composto da: miscelatore a incasso con deviatore BROOKLYN, attacco presa acqua a muro con supporto per doccetta su piastra BROOKLYN, braccio a muro in ottone 30cm con rosetta BROOKLYN, soffione in ottone, doccetta in ottone a 1 funzione, flessibile 150cm.
Built-in shower set, including: built-in mixer with diverter BROOKLYN, wall water connection with hand shower holder on BROOKLYN plate, 30cm brass wall arm with BROOKLYN flange, brass shower head, 1-function brass hand shower, 150cm flexible hose.

BY615GZ0CR

Con soffione da Ø 20 cm.
 With head shower Ø 20 cm.

CR	FIN A	FIN B
----	-------	-------

BY615GZ09430CR

Con soffione da Ø 30 cm.
 With head shower Ø 30 cm.

CR	FIN A	FIN B
----	-------	-------



Set doccia a incasso, composto da: miscelatore a incasso su piastra unica con deviatore a 2 vie, presa acqua con doccetta in ottone e flessibile 150 cm, braccio a muro in ottone 30cm con rosetta BROOKLYN, soffione in ottone.
Built-in shower set, including: built-in mixer on 1 plate with 2-way diverter, water intake with brass hand-shower and 150cm hose, 30cm brass wall arm with BROOKLYN flange, brass shower head.

BY715Z0D2CR

Con soffione da Ø 20 cm.
 With head shower Ø 20 cm.

CR	FIN A	FIN B
----	-------	-------

BY715Z0D29430CR

Con soffione da Ø 30 cm.
 With head shower Ø 30 cm.

CR	FIN A	FIN B
----	-------	-------



Set doccia a incasso, composto da: miscelatore a incasso su 3 piastre tonde con deviatore a 2 vie, presa acqua con doccetta in ottone e flessibile 150 cm, braccio a muro in ottone 30cm con rosetta BROOKLYN, soffione in ottone.

NB: miscelatore, deviatore e doccetta hanno piastre esterne separate, ma un'unica parte a incasso.

Built-in shower set, including: built-in mixer on 3 round plates with 2-way diverter, water intake with brass hand-shower and 150cm hose, 30cm brass wall arm with BROOKLYN flange, brass shower head.

NB: mixer, diverter and hand-shower intake are on separate plates, but share one single built-in part.

BY715Z0D2PCR

Con soffione da Ø 20 cm.
 With head shower Ø 20 cm.

CR	FIN A	FIN B
----	-------	-------

BY715Z0D2P9430CR

Con soffione da Ø 30 cm.
 With head shower Ø 30 cm.

CR	FIN A	FIN B
----	-------	-------

REVIVAL

La collezione Revival rappresenta l'espressione più classica tra le serie di Daniel Rubinetterie. Miscelatori bicomando in cui il gusto e l'eleganza delle forme si fonde armoniosamente con la più raffinata tradizione. L'ampia possibilità di finiture permette inoltre di scegliere la combinazione più adatta ad arricchire ogni singolo progetto, accentuando i toni antichi negli ambienti dal gusto retrò o sperimentando nuovi abbinamenti con le tinte degli arredi moderni.

REVIVAL collection represents the most classical expression between Daniel Rubinetterie series. Double-lever mixers in which the shapes taste and elegance harmoniously blends with the finest tradition. The wide range of finishes allows also to choose the most suitable combination to enrich every single project, highlighting the ancient tones in "retro" environments or experimenting new colors combinations with modern furniture tints.





V5003L

CARATTERISTICHE TECNICHE:

La serie è dotata di vitone ceramico,
prodotto da S.T.S.R. Studio Tecnico Sviluppo e Ricerche
www.stsr.it

TECHNICAL FEATURES:

The series is equipped with ceramic headvalves,
produced by S.T.S.R. - Research Development Technical Office
www.stsr.it



V5400



V5003L

OPZIONE LEVA - LEVER OPTION

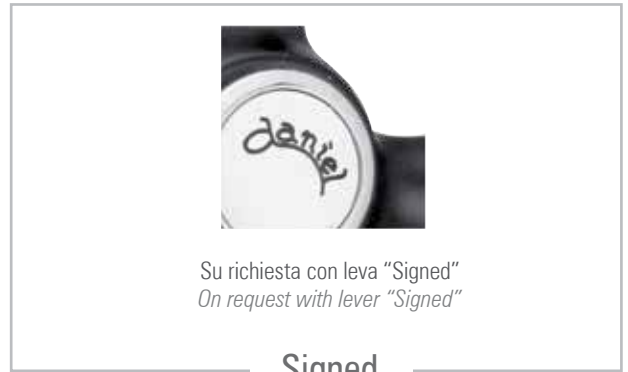
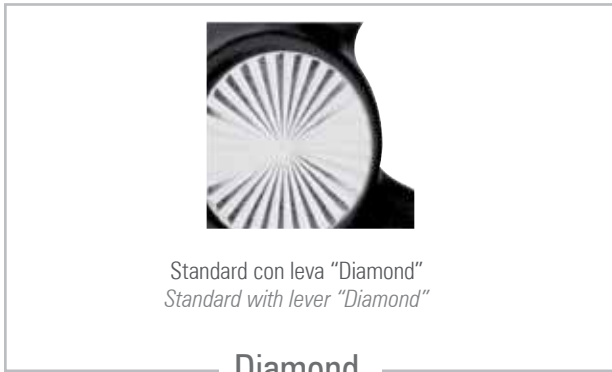

LAVABI - WASHBASIN MIXERS





V5118

Monoforo lavabo con canna fusa corta e scarico.

One hole washbasin mixer with short casted spout and pop-up waste.

CR FIN A FIN B



V5112L

Monoforo lavabo con scarico click-clack.

One hole washbasin mixer with click-clack pop-up waste.

CR FIN A FIN B



V5003

Batteria lavabo con scarico.

Washbasin set with pop-up waste.

CR FIN A FIN B



V5112

Monoforo lavabo con scarico.

One hole washbasin mixer with pop-up waste.

CR FIN A FIN B



V5022

Batteria lavabo/lavello da incasso.

Concealed basin/sinkz mixer.

CR FIN A FIN B

BIDET



V6300

Batteria bidet con scarico e doccia.

Bidet set with pop-up waste and shower.

CR FIN A FIN B



V6400

Monoforo bidet canna antica e scarico.

One hole bidet mixer with "Antique" spout and pop-up waste.

CR FIN A FIN B



V6302

Batteria bidet con scarico.

Three holes bidet set with pop-up waste.

CR FIN A FIN B



V6200

Monoforo bidet con scarico.

One hole bidet mixer with pop-up waste.

CR FIN A FIN B



V604

Miscelatore monofofo bidet con scarico.

One hole single lever bidet mixer with pop-up waste.

CR FIN A FIN B



V6004

Batteria bidet canna antica con scarico.

Three holes bidet mixer with "Antique" spout and pop-up waste.

CR FIN A FIN B



V6080

Combinazione bidet senza scarico.
Bidet supply fitting without waste.

CR FIN A FIN B



V6030

Combinazione bidet con scarico.
Bidet supply fitting with pop-up waste.

CR FIN A FIN B



V645

Miscelatore incasso per shut-off serie Revival
comprensivo di doccetta shut-off art. 1000BDC,
supporto doccia-presa acqua, tutto in ottone
cromato e flessibile doccia cm 120
Built-in shower mixer set Revival series
including shut-off art. 1000BDC, shower holder-
water punch on flange, all in c.p. brass and
shower flexible cm 120.

CR FIN A FIN B

MISCELATORI VASCA E DOCCIA - SHOWER AND BATH MIXERS



V4101

Gruppo vasca esterno, con kit doccia, doccia
duplex e flessibile 150 cm.
Bathtub mixer, with shower kit, duplex shower
and flexible 150 cm.

CR FIN A FIN B

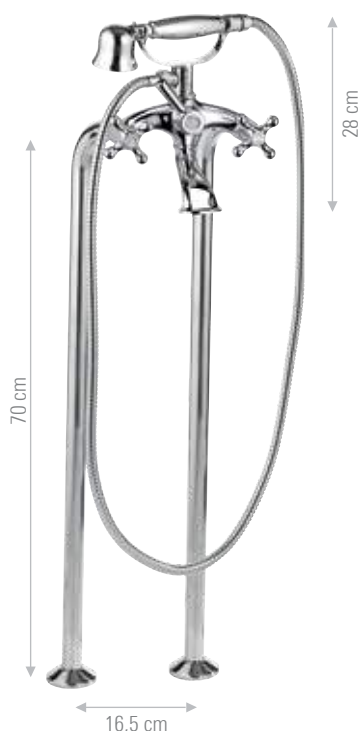

V4101XL

Gruppo vasca esterno su colonne da pavimento,
con doccia duplex.
Traditional bathtub mixer, on floor columns, with
duplex shower.

CR FIN A FIN B

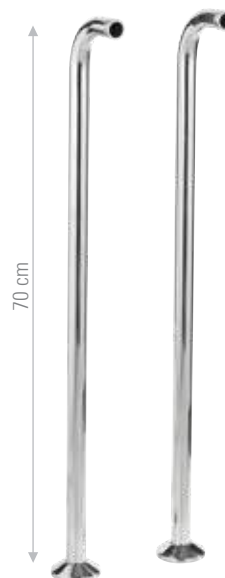

A880XL

Colonne da pavimento.
Floor columns.

CR FIN A FIN B



V4101UK

Gruppo vasca esterno su colonnette alte con flessibile cm 150 e doccia duplex.

Bathtub mixer on high studs with flexible cm 150 and duplex shower.

CR FIN A FIN B



V4100Z

Gruppo vasca con deviatore e attacco 3/4M.

Bathtub mixer with diverter and 3/4M connection.

CR FIN A FIN B



V4192

Batteria bordo vasca con doccia estraibile.

Bathtub set with pull-out shower.

CR FIN A FIN B



V7623S

Miscelatore lavabo/vasca con canna "S" cm 30 e deviatore, con kit doccia.

Exposed basin/bath mixer with "S" spout cm 30 and diverter, with shower kit.

CR FIN A FIN B



V4433A

Gruppo doccia esterno, con kit doccia.

Wall-mounted shower mixer, with duplex shower.

CR FIN A FIN B

V7623SH

Miscelatore lavabo/vasca con canna "S" cm 30 e deviatore, senza kit doccia.

Exposed basin/bath mixer with "S" spout cm 30 and diverter, without shower kit.

CR FIN A FIN B

V4433

Gruppo doccia esterno, senza kit doccia.

Wall-mounted shower mixer, without duplex shower.

CR FIN A FIN B



A308404

Saliscendi Revival, cm 60 con asta tonda Ø 25 mm e doccetta completamente in ottone cromato.

Revival sliding rail, round rod Ø 25 mm length cm 60 with handshower completely in CP brass.

CR FIN A FIN B



V4440

Batteria vasca incasso con deviatore composta da presa acqua con flessibile e doccetta, bocca, tutto in ottone cromato.

Built-in bathtub mixer with diverter composed by water connector with flexible and handshower, spout, all in c.p. brass.

CR FIN A FIN B



V444189

Batteria vasca incasso con deviatore composta da presa acqua con flessibile e doccetta, braccio doccia con soffione, tutto in ottone cromato.

Built-in bathtub mixer with diverter composed by water connector with flexible and handshower, shower arm with shower head, all in c.p. brass.

CR FIN A FIN B

A398404

Saliscendi Revival, cm 90 con asta tonda Ø 25 mm e doccetta completamente in ottone cromato.

Revival sliding rail, round rod Ø 25 mm length cm 90 with handshower completely in CP brass.

CR FIN A FIN B



V4306

Gruppo vasca esterno con doccia e canna lunga girevole, lunghezza 40 cm.
Bathtub mixer with shower and long movable spout, length 40 cm.

CR FIN A FIN B



V4433Z

Gruppo doccia esterno attacco 3/4 per colonna doccia.
Wall-mounted shower mixer connection 3/4 for columns.

CR FIN A FIN B

BOCCHE E ACCESSORI - SPOUTS & ACCESSORIES



A705LICC

Colonna di scarico con sifone per vasca con tubo in rame cromato e piletta click-clack, tutta cromata.
Bath brass waste with siphon, trap chrome plated, copper tube and click clack waste, all chrome plated.

CR FIN A FIN B



A705LIT

Colonna di scarico con sifone per vasca con tubo in rame cromato, tutta cromata.
Bath brass waste with siphon, trap and chrome plated copper tube, all in chrome plated.

CR FIN A FIN B



V9200
 Maniglia Revival.
Revival handle.

CR FIN A FIN B



V4454
 Rubinetto doccia incasso 1/2.
Built-in right valve 1/2.

CR FIN A FIN B



L4704
 Bocca incasso.
Built-in spout.

CR FIN A FIN B

INCASSI DOCCIA - BUILT-IN MIXERS



V630
 Maniglia Revival
Revival handle

CR FIN A FIN B



V602
 Miscelatore monocomando doccia incasso.
Single lever built-in shower mixer.

CR FIN A FIN B



V612
 Miscelatore monocomando incasso con deviatore per vasca/doccia.
Single lever built-in bath/shower mixer with diverter

CR FIN A FIN B

COLONNE DOCCIA E VASCA - SHOWER AND BATH COLUMN

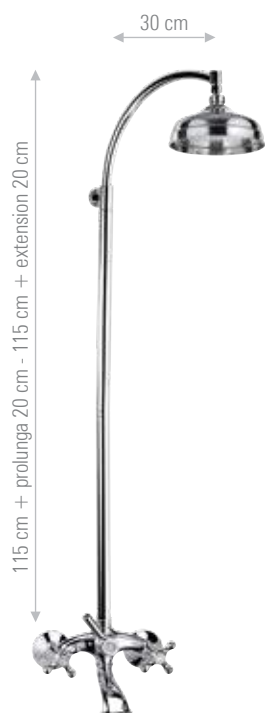

V413789

Gruppo vasca con colonna girevole e soffione tutto in ottone cromato.
Bathtub mixer with column and shower head all in c.p. brass.

CR FIN A FIN B



V413689

Gruppo vasca con colonna saliscendi girevole e deviatore con doccia, flessibile e soffione tutto in ottone cromato.
Bathtub mixer with sliding rail column and diverter with shower, flexible and shower head all in brass.

CR FIN A FIN B



V443789

Gruppo doccia con colonna girevole e soffione tutto in ottone cromato.
Shower mixer with column and shower head all in C.P. brass.

CR FIN A FIN B



V443689

Gruppo doccia con colonna saliscendi girevole e deviatore con doccia, flessibile e soffione tutto in ottone cromato.
Shower mixer with sliding rail column and diverter with shower, flexible and shower head all in c.p. brass.

CR FIN A FIN B



V7114

Monoforo lavello con canna antica.
One hole sink mixer with "Antique" spout.

CR FIN A FIN B



V7112

Monoforo lavello con bocca fusa girevole.
One hole sink mixer with swiveling casted spout.

CR FIN A FIN B



V7100

Monoforo lavello con bocca girevole.
One hole sink mixer with swiveling spout.

CR FIN A FIN B



V7007

Gruppo lavello a muro con canna antica.
Wall-mounted sink set with "Antique" spout.

CR FIN A FIN B



V7005

Gruppo lavello a muro con canna "J" tubo superiore.
Wall-mounted sink set with upper "J" spout.

CR FIN A FIN B



V7004

Gruppo lavello a muro con canna tubo a "S".
Wall-mounted sink set with "S" tube lower spout.

CR FIN A FIN B



V7000

Gruppo lavello a muro con canna superiore.
Wall-mounted sink set with "upper" spout.

CR FIN A FIN B



V7006

Gruppo lavello a muro con con bocca girevole.
Wall-mounted sink set with swiveling spout.

CR FIN A FIN B

MONOACQUA - SINGLE WATER



V7202

Rubinetto a muro con canna bassa.
Sink tap with lower spout.

CR FIN A FIN B



V7200U

Rubinetto a muro con canna superiore a "U".
Sink tap with upper "U" spout.

CR FIN A FIN B



V7200J

Rubinetto a muro con canna superiore a "J".
Sink tap with upper "J" spout.

CR FIN A FIN B



V7250

Rubinetto a muro con canna superiore a "U".
Sink tap with upper "U" spout.

CR FIN A FIN B



V5009

Rubinetto collo a cigno, 1/2, 3/4.
Wash basin pillar tap, 1/2, 3/4.

CR FIN A FIN B



V7250U

Rubinetto a colonnina con canna superiore a U.
Bar faucet with upper U spout.

CR FIN A FIN B



V7200

Rubinetto a squadra per lavatrice 1/2"x3/4".
Angle tap for washing machine 1/2"x3/4".

CR FIN A FIN B



V720012

Rubinetto a squadra per lavatrice 1/2"x1/2".
Angle tap for washing machine 1/2"x1/2".

CR FIN A FIN B



V7222

Rubinetto prolungato.
Extended tap.

CR FIN A FIN B



V7230

Rubinetto con portagomma.
Tap with hose union.

CR FIN A FIN B



V7210

Rubinetto a snodo con attacco lavatrice, 1/2.
Washing machine bibcock, with swiveling spout.

CR FIN A FIN B



V7212

Rubinetto curvo con uscita da 1/2" e uscita da bocca di erogazione, attacco 1/2" M.
Angle tap with 1/2" output and spout output, 1/2" M connection.

CR FIN A FIN B

RETRO

La collezione Retrò rappresenta un piccolo viaggio in profili e ricordi del passato. La soluzione di arredo ideale per aggiungere una classe di altri tempi ai gesti quotidiani.

The RETRO collection represents a small trip into profiles and memories of the past. The ideal furnishing solution to add a yesteryear class to of to everyday gestures.



RETRO

RT5022



CARATTERISTICHE TECNICHE:

La serie è dotata di vitone ceramico,
prodotto da S.T.S.R. Studio Tecnico Sviluppo e Ricerche
www.stsr.it

TECHNICAL FEATURES:

The series is equipped with ceramic headvalves,
produced by S.T.S.R. - Research Development Technical Office
www.stsr.it



RT5400



RT5003L

OPZIONE LEVA - LEVER OPTION



Es: RTV605



Es: RTV605AU

LAVABI - WASHBASIN MIXERS



RTV605

Miscelatore monocomando lavabo con scarico.
Single lever washbasin mixer with pop-up waste.

CR FIN A FIN B



RT5400

Monoforo lavabo con canna antica e scarico.
One hole washbasin mixer with "Antique" spout and pop-up waste.

CR FIN A FIN B



RT5003L

Batteria lavabo con canna fusa corta e scarico.
Three holes washbasin mixer with casted spout and pop-up waste.

CR FIN A FIN B



RT5104

Batteria lavabo con canna antica e scarico.
Washbasin set with "Antique" spout and pop-up waste.

CR FIN A FIN B



RT5112L

Monoforo lavabo con scarico click-clack.
One hole washbasin mixer with click-clack pop-up waste.

CR FIN A FIN B



RT5112

Monoforo lavabo con scarico.
One hole washbasin mixer with pop-up waste.

CR FIN A FIN B



RT5003

Batteria lavabo con scarico.
Washbasin set with pop-up waste.

CR FIN A FIN B



RT5022

Batteria lavabo/lavello da incasso.
Concealed basin/sink mixer.

CR FIN A FIN B

BIDET - BIDET MIXERS



RT6200

Monoforo bidet con scarico.
One hole bidet mixer with pop-up waste.

CR FIN A FIN B



RTV604

Miscelatore monocomando bidet con scarico.
Single lever bidet mixer with pop-up waste.

CR FIN A FIN B



RT6400

Monoforo bidet canna antica con scarico.
One hole bidet mixer with "Antique" spout and pop-up waste.

CR FIN A FIN B



RT6302

Batteria bidet con scarico.
Three holes bidet set with pop-up waste.

CR FIN A FIN B



RT6030

Combinazione bidet con scarico.
Bidet supply fitting with pop-up waste.

CR FIN A FIN B



RT6004

Batteria bidet con canna antica e scarico.
Bidet set with "Antique" spout and pop-up waste.

CR FIN A FIN B



RT645

Miscelatore incasso per shut-off serie Retrò comprensivo di doccetta shut-off art. 1000BDC, supporto doccia-presa acqua, tutto in ottone cromato e flessibile doccia cm 120.
Built-in shower mixer set Retrò series including shut-off art. 1000BDC, shower holder-water punch on flange, all in c.p. brass and shower flexible cm 120.

CR FIN A FIN B

MISCELATORI VASCA E DOCCIA - SHOWER AND BATH MIXERS



RT4102

Gruppo vasca esterno con kit doccia, doccia e flessibile 120 cm.
Bathtub mixer with shower kit and flexible 120 cm

CR FIN A FIN B



RT4102UK

Gruppo vasca esterno su colonnette alte con flessibile cm 120 e doccetta in ottone ad 1 funzione.
Bathtub mixer on high studs with flexible cm 120 and 1-function brass hand shower.

CR FIN A FIN B

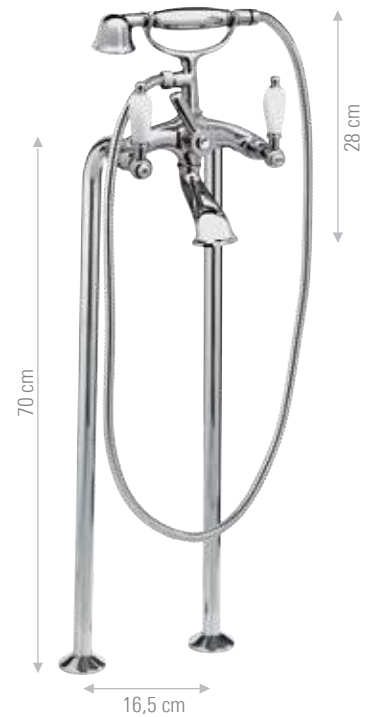

RT4102XL

Gruppo vasca esterno su colonne da pavimento, con doccia.
Traditional bathtub mixer, on floor columns, with shower.

CR FIN A FIN B



RT4433A

Gruppo doccia esterno, con kit doccia.
Wall-mounted shower mixer, with shower kit.

CR FIN A FIN B



RT4192

Batteria bordo vasca con doccia estraibile.
Bathtub set with pull-out shower.

CR FIN A FIN B



RT4433

Gruppo doccia esterno, senza kit doccia.
Wall-mounted shower mixer, without shower kit.

CR FIN A FIN B



RT4100Z

Gruppo vasca con deviatore e attacco 3/4M.
Bathtub mixer with diverter and 3/4M connection.

CR FIN A FIN B



RT4433Z

Gruppo doccia esterno attacco 3/4 per colonna doccia.
Wall-mounted shower mixer connection 3/4 for columns.

CR FIN A FIN B

INCASSI DOCCIA - BUILT-IN MIXERS



RT602

Miscelatore monocomando doccia incasso.
Single lever built-in shower mixer.

CR FIN A FIN B



RT612

Miscelatore monocomando incasso con deviatore per vasca/doccia.
Single lever built-in bath/shower mixer with diverter.

CR FIN A FIN B

COLONNE DOCCIA E VASCA - SHOWER AND BATH COLUMN

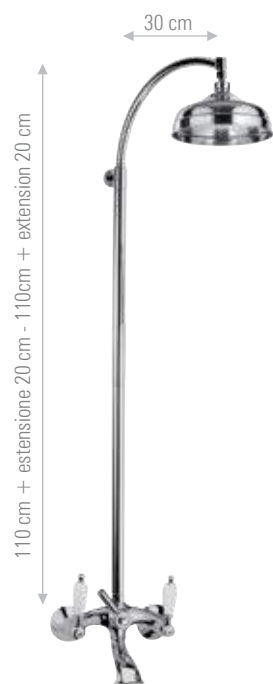

RT413789

Gruppo vasca con colonna girevole e soffione tutto in ottone cromato.
Bathtub mixer with column and shower head all in brass.

CR

FIN A

FIN B



RT413689

Gruppo vasca con colonna saliscendi girevole e deviatore con doccia, flessibile e soffione tutto in ottone cromato.
Bathtub mixer with sliding rail column and diverter with shower, flexible and shower head all in brass.

CR

FIN A

FIN B



RT443789

Gruppo doccia con colonna girevole e soffione tutto in ottone cromato.
Shower mixer with swivelling column and shower head all in C.P. brass.

CR

FIN A

FIN B



RT443689

Gruppo doccia con colonna saliscendi girevole e deviatore con doccia, flessibile e soffione tutto in ottone cromato.
Shower mixer with sliding rail column and diverter with shower, flexible and shower head. All in C.P. brass.

CR

FIN A

FIN B

CUCINA - KITCHEN



RT7007
Gruppo lavello a muro con canna antica.
Wall-mounted sink set with "Antique" spout.

CR FIN A FIN B



RT7114
Monoforo lavello con canna antica.
One hole sink mixer with "Antique" spout.

CR FIN A FIN B



RT7250A
Rubinetto a colonnina.
Bar faucet.

CR FIN A FIN B

ACCESSORI - ACCESSORIES



RT9200
Maniglia Retrò cromata con impugnatura bianca "cold".
"Cold" chromed Retrò handle with white knob.

CR FIN A FIN B

RT9200H
Maniglia Retrò cromata con impugnatura bianca "hot".
"Hot" chromed Retrò handle with white knob.



RT9200AU
Maniglia Retrò cromata "cold".
"Cold" chromed retrò handle.

CR FIN A FIN B

RT9200AUH
Maniglia Retrò cromata "hot".
"Hot" chromed retrò handle.



RT630MANCR
Maniglia Retrò cromata con impugnatura bianca.
Chromed Retrò handle with white knob.

CR FIN A FIN B



RT630AUMANCR
Maniglia Retrò cromata.
Chromed retrò handle.

CR FIN A FIN B



RT7114

CRYSTAL RETRÒ

La collezione CRYSTAL RETRÒ propone una rubinetteria bicomando dedicata ad un gusto antico e principesco. Tutta l'eleganza classica della serie viene arricchita da maniglie in cristallo Swarovski, creando un prezioso gioco di riflessi e trasparenze. Qui proposta in abbinamento alla colorazione oro lucido (DO), CRYSTAL RETRÒ può essere personalizzata in base agli arredi secondo le diverse finiture a catalogo.

CRYSTAL RETRÒ presents a dual-control taps collection dedicated to an ancient and princely taste. All the classic elegance of the series is enriched with Swarovski crystal handles, creating a precious play of reflections and transparencies. Here proposed in combination with the shiny gold coloring (DO), CRYSTAL RETRÒ can be customized according to the furniture and following the different finishings in the catalog.



CRYSTAL RETRÒ

RC5112D0



CARATTERISTICHE TECNICHE:

Leve con cristallo Swarovski.
La serie è dotata di vitone ceramico,
prodotto da S.T.S.R. Studio Tecnico Sviluppo e Ricerche
www.stsr.it

TECHNICAL FEATURES:

Levers with Swarovski crystal.
The series is equipped with ceramic headvalves,
produced by S.T.S.R. - Research Development Technical Office
www.stsr.it



RC5112DO

OPZIONE LEVA - LEVER OPTION

NB: il codice identificativo della maniglia è all'inizio del codice prodotto.
 NB: the identification code of the handle is at the beginning of the product code.



RC

Maniglia sferica di cristallo (codice RC).
 Non disponibile per articoli monocomando.
*Crystal spherical handle (code RC).
 Not available for single-lever items.*

Es: **RC5112DO**



RY

Maniglia lunga di cristallo retrò (codice RY).
Retrò long crystal handle (code RY).

Es: **RY5112DO**

LAVABI - WASHBASIN MIXERS



17 cm
11 cm

RYV605DO
 Miscelatore monocomando lavabo con scarico.
Single lever washbasin mixer with pop-up waste.

RC CR FIN A FIN B

RY CR FIN A FIN B



23,5 cm
23 cm

RY5400DO
 Monoforo lavabo con canna antica e scarico.
One hole washbasin mixer with "Antique" spout and pop-up waste.

RC CR FIN A FIN B

RY CR FIN A FIN B



15 cm
13 cm

RY5003LDO
 Batteria lavabo con canna fusa corta e scarico.
Three holes washbasin mixer with casted spout and pop-up waste.

RC CR FIN A FIN B

RY CR FIN A FIN B

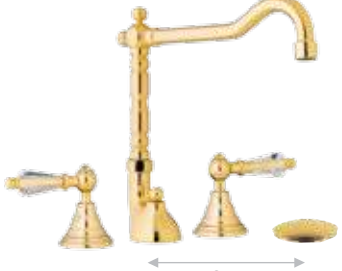

26,5 cm
19 cm

RY5104DO
 Batteria lavabo con canna antica e scarico.
Washbasin set with "Antique" spout and pop-up waste.

RC CR FIN A FIN B

RY CR FIN A FIN B



17,5 cm
13 cm

RY5112LDO
 Monoforo lavabo con scarico click-clack.
One hole washbasin mixer with click-clack pop-up waste.

RC CR FIN A FIN B

RY CR FIN A FIN B



14 cm
5,5 cm

RY5003DO
 Batteria lavabo con scarico.
Washbasin set with pop-up waste

RC CR FIN A FIN B

RY CR FIN A FIN B

BIDET - BIDET MIXERS

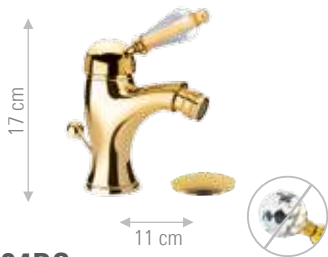

RYV604DO

Miscelatore monocomando bidet con scarico.
Single lever bidet mixer with pop-up waste.

RY CR FIN A FIN B



RY6400DO

Monoforo bidet canna antica con scarico.
One hole bidet mixer with "Antique" spout and pop-up waste.

RC CR FIN A FIN B

RY CR FIN A FIN B



RY6200DO

Monoforo bidet con scarico.
One hole bidet mixer with pop-up waste.

RC CR FIN A FIN B

RY CR FIN A FIN B



RY6302DO

Batteria bidet con scarico.
Three holes bidet set with pop-up waste.

RC CR FIN A FIN B

RY CR FIN A FIN B



RY6004DO

Batteria bidet con canna antica e scarico.
Bidet set with "Antique" spout and pop-up waste.

RC CR FIN A FIN B

RY CR FIN A FIN B

MISCELATORI VASCA E DOCCIA - SHOWER AND BATH MIXERS



RY4102DO

Gruppo vasca esterno con kit doccia, doccia e flessibile 120 cm.
Bathtub mixer with shower kit and flexible 120 cm.

RC CR FIN A FIN B

RY CR FIN A FIN B



RY4192DO

Batteria bordo vasca con doccia estraibile.
Bathtub set with pull-out shower.

RC CR FIN A FIN B

RY CR FIN A FIN B



RY4102UKDO

Gruppo vasca esterno su colonnette alte con flessibile cm 120 e doccetta in ottone ad 1 funzione.
Bathtub mixer on high studs with flexible cm 120 and 1-function brass hand shower.

RC CR FIN A FIN B

RY CR FIN A FIN B



RY4102XLDO

Gruppo vasca esterno su colonne da pavimento, con doccetta in ottone ad 1 funzione.

Traditional bathtub mixer, on floor columns, with 1-function brass hand shower.

RC	CR	FIN A	FIN B
RY	CR	FIN A	FIN B



RY4440DO

Batteria vasca incasso con deviatore completa di set doccia e bocca a incasso.

Built-in bathtub mixer with diverter complete of shower kit and built-in spout.

RC	CR	FIN A	FIN B
RY	CR	FIN A	FIN B



RY444189DO

Batteria vasca incasso con deviatore, presa acqua con flessibile cm 150 e doccetta ad 1 funzione e braccio doccia con soffione. Tutto in ottone.

Built-in bathtub mixer with diverter, water punch/shower holder with flexible cm 150 and 1 function handshower, shower arm with shower head. All in brass.

RC	CR	FIN A	FIN B
RY	CR	FIN A	FIN B



RY6400DO

Gruppo doccia esterno, con kit doccia.

Wall-mounted shower mixer, with shower kit.

RC	CR	FIN A	FIN B
RY	CR	FIN A	FIN B



RY4433DO

Gruppo doccia esterno, senza kit doccia.

Wall-mounted shower mixer, without shower kit.

RC	CR	FIN A	FIN B
RY	CR	FIN A	FIN B



RY4433ZDO

Gruppo doccia esterno attacco 3/4 per colonna doccia.

Wall-mounted shower mixer connection 3/4 for columns.

RC	CR	FIN A	FIN B
RY	CR	FIN A	FIN B



RY4100ZDO

Gruppo vasca con deviatore e attacco 3/4M.

Bathtub mixer with diverter and 3/4M connection.

RC	CR	FIN A	FIN B
RY	CR	FIN A	FIN B

INCASSI DOCCIA - BUILT-IN MIXERS



RY602DO

Miscelatore monocomando doccia incasso.
Single lever built-in shower mixer.

RY	CR	FIN A	FIN B
----	----	-------	-------



RY612DO

Miscelatore monocomando incasso con deviatore per vasca/doccia.
Single lever built-in bath/shower mixer with diverter.

RY	CR	FIN A	FIN B
----	----	-------	-------

COLONNE DOCCIA E VASCA - SHOWER AND BATH COLUMN



RY413689DO

Gruppo vasca con colonna saliscendi girevole e deviatore con doccia, flessibile e soffione tutto in ottone.
Bath tub mixer with sliding rail column and diverter with shower, flexible and shower head all in brass.

RC	CR	FIN A	FIN B
RY	CR	FIN A	FIN B



RY443689DO

Gruppo doccia con colonna saliscendi girevole e deviatore con doccia, flessibile e soffione tutto in ottone.
Shower mixer with sliding rail column and diverter with shower, flexible and shower head all in brass.

RC	CR	FIN A	FIN B
RY	CR	FIN A	FIN B



RY109DO

Kit doccia composto da miscelatore esterno doccia, saliscendi, doccetta e flessibile 150 cm, tutto in ottone. *Shower kit composed of shower mixer, sliding rail, handshower and flexible hose cm. 150, all in brass.*

RC CR FIN A FIN B

RY CR FIN A FIN B



RY645DO

Miscelatore incasso per shut-off comprensivo di doccetta shut-off, supporto doccia-presa acqua e flessibile doccia cm 120. *Built-in shower mixer set including :shut-off, shower holder-water punch on flange and shower flexible cm 120.*

RY CR FIN A FIN B

RC9200DO

Maniglia sferica di cristallo. *Crystal spherical handle.*



RC CR FIN A FIN B

RY630MANDO

Maniglia lunga di cristallo Retrò. *Retrò long crystal handle.*



RY CR FIN A FIN B



RY9200DO

Maniglia lunga di cristallo Retrò. *Retrò long crystal handle.*

RY CR FIN A FIN B

ACCESSORI - ACCESSORIES



A705LICEDO

Colonna di scarico con sifone per vasca con tubo in rame e piletta click-clack. *Bath brass waste with siphon, trap, copper tube and click clack waste.*

CR FIN A FIN B



A705LITDO

Colonna di scarico con sifone per vasca con tubo in rame. *Bath brass waste with siphon, trap and copper tube.*

CR FIN A FIN B



A736DO

Scarico automatico con sistema click-clack, 1"1/4, e tappo grande, senza troppo pieno. *Automatic pop-waste, click-clack system, 1"1/4, big plug, without overflow.*

CR FIN A FIN B



A735D0

Scarico automatico con sistema click-clack, 1"1/4, e tappo grande, con troppo pieno.
Automatic pop-waste, click-clack system, 1"1/4, big plug, with overflow.

CR	FIN A	FIN B
----	-------	-------



A750D0

Sifone minimale in ottone dorato 1"1/4.
Gold brass minimal P trap 1"1/4.

CR	FIN A	FIN B
----	-------	-------



A765D0114

Sifone a bottiglia, canotto cm 25 in ottone, 1"1/4.
Bottle trap, 25 cm outlet tube in brass, 1"1/4.

CR	FIN A	FIN B
----	-------	-------

CUCINA - KITCHEN



RY7007D0

Gruppo lavello a muro con canna antica.
Wall-mounted sink set with "Antique" spout.

RC	CR	FIN A	FIN B
RY	CR	FIN A	FIN B

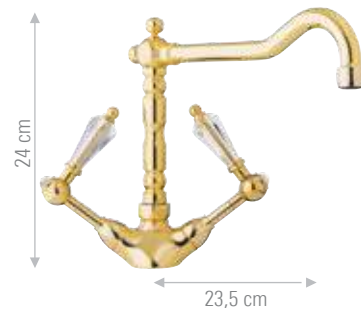

RY7114D0

Monoforo lavello con canna antica.
One hole sink mixer with "Antique" spout.

RC	CR	FIN A	FIN B
RY	CR	FIN A	FIN B

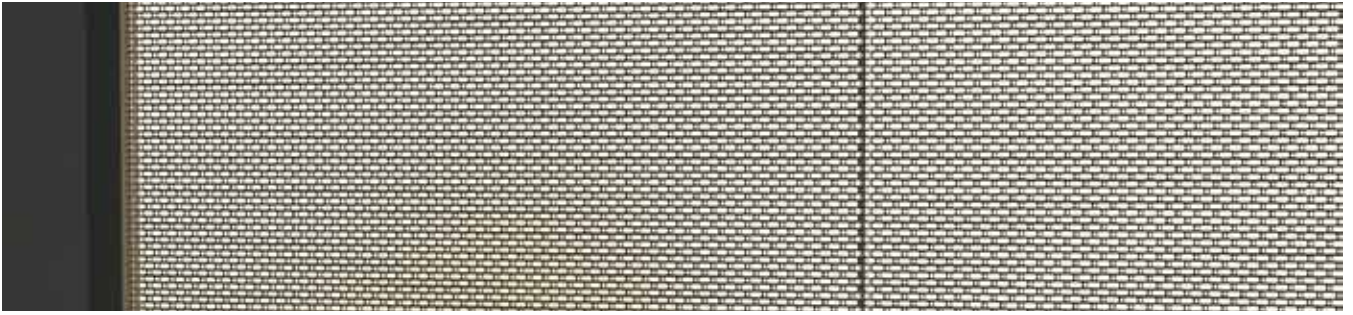

CASCATA E COLORE WATERFALL & COLOR



CU699

CUBE WATERFALL

pag 334

CEILING COLUMN

pag 342

CUBE WATERFALL

Cube waterfall nasce dal desiderio di combinare forme spiccatamente moderne con l'incanto e l'armoniosità di una cascata naturale. Una collezione addolcita dai particolari scivoli cromati che permettono di osservare l'acqua corrente durante il suo fluire.

Cube waterfall comes from the desire to combine distinctly modern shapes with the charm and the harmony of a natural waterfall. A collection softened by the particular chromed slides allowing to observe the water during its flow.





CW606

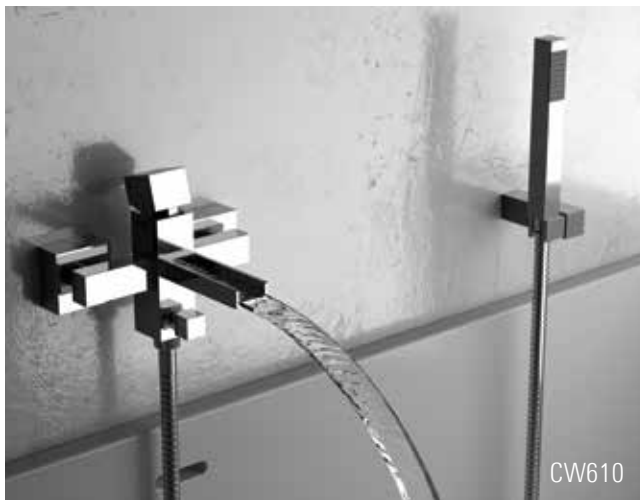

CW610



CW688

CARATTERISTICHE TECNICHE:

La serie è dotata di cartuccia a dischi ceramici, Ø 35 mm, prodotta da S.T.S.R. – Studio Tecnico Sviluppo e Ricerche - www.stsr.it

TECHNICAL FEATURES:

The series is equipped with ceramic cartridge, Ø 35 mm, produced by S.T.S.R. - Research Development Technical Office - www.stsr.it



CW607B

LAVABI E BIDET - WASHBASIN MIXERS AND BIDET



CW605
 Monocomando lavabo con bocca a cascata, con scarico.
Single-lever basin mixer with waterfall spout, with pop-up waste.

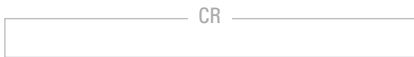

CW606
 Monocomando lavabo con bocca a cascata, senza scarico.
Single-lever basin mixer with waterfall spout, without pop-up waste.

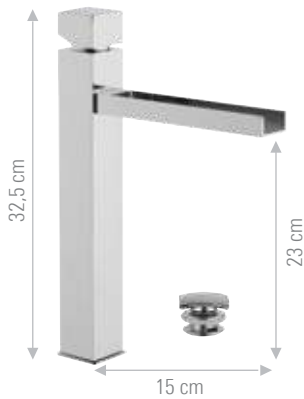
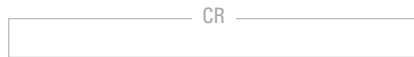

CW607
 Monocomando lavabo alto con bocca a cascata, con scarico click-clack.
High basin mixer with waterfall spout, with click-clack waste.

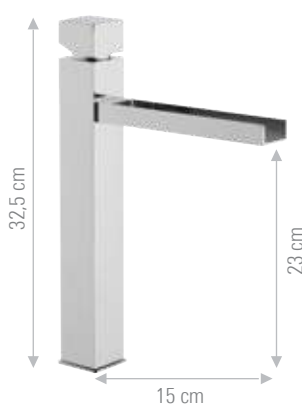
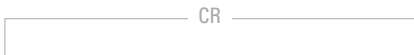

CW607B
 Monocomando lavabo alto con bocca a cascata, senza scarico.
High basin mixer with waterfall spout, without waste.

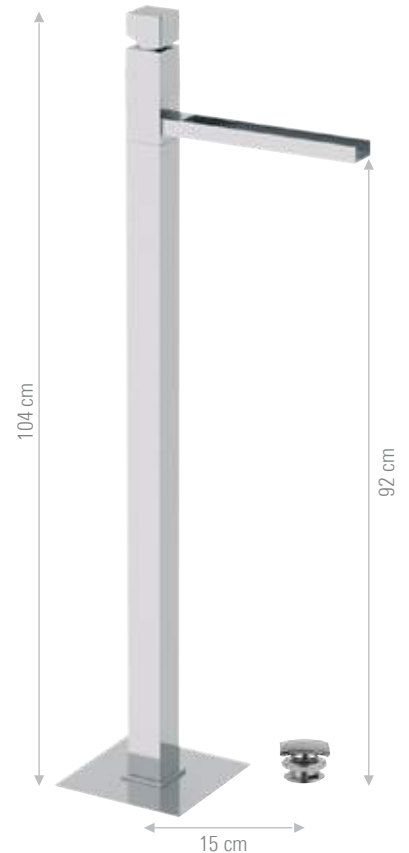

CW688
 Miscelatore monocomando lavabo da pavimento con click-clack e troppo pieno.
Single-lever mixer floor mounting with click-clack and overflow.

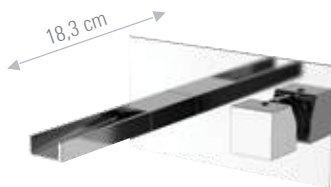

CW632
 Miscelatore monocomando a incasso per lavabo, con piastra rettangolare.
Single-lever built-in basin mixer, with rectangular wall flange.

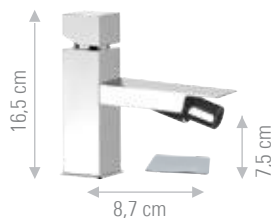
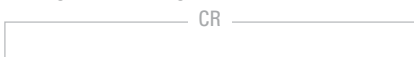

CU604
 Monocomando bidet, con scarico.
Single-lever bidet mixer, with pop-up waste.

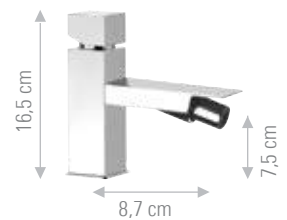

CU604B
 Monocomando bidet, senza scarico.
Single-lever bidet mixer, without waste.



INCASSI DOCCIA E BOCCHE - BUILT-IN MIXERS AND SPOUTS



CU602

Miscelatore doccia incasso.
Built-in shower single-lever mixer.

CR



CU612

Miscelatore monocomando incasso con deviatore per vasca/doccia.
Built-in bath/shower mixer with diverter.

CR

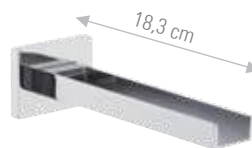

CW4704

Bocca incasso a cascata.
Waterfall built-in spout.

CR



C4705Q

Bocca bordo vasca a cascata.
Waterfall built-in spout.

CR



F4705Q

Bocca bordo vasca con effetto multigetto.
Spout with multijet effect for deck bath/shower mixer.

CR



CA4704

Bocca incasso a cascata.
Built-in spout with waterfall jet.

CR

MISCELATORI VASCA E DOCCIA - SHOWER AND BATH MIXERS



CU699

Miscelatore monocomando bordo vasca.
Single lever deck bath/shower mixer.

CR

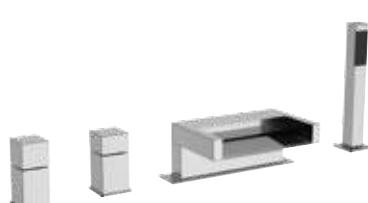

CU697

Miscelatore monocomando bordo vasca.
Single lever deck bath/shower mixer.

CR



CU652

Miscelatore monocomando per vasca da incasso, su piastra in ottone cromato.
Single-lever bath mixer, with wall flange in chrome plated.

CR

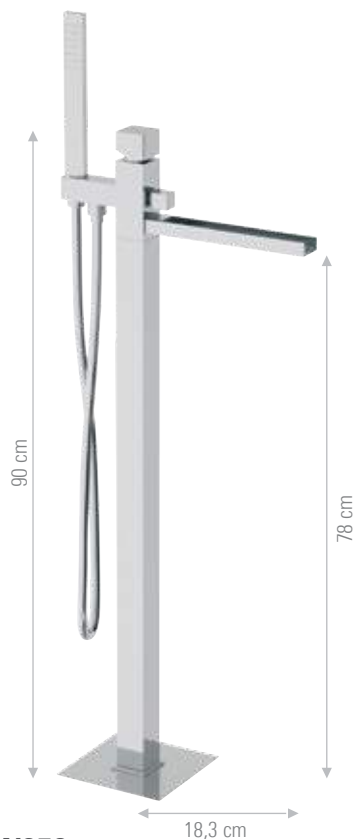

CW678

Miscelatore vasca da pavimento con bocca a cascata, con deviatore e kit doccia.
Free standing bath mixer floor mounting with waterfall spout, with diverter and shower kit.

CR



CW610

Miscelatore vasca esterno con bocca a cascata, con kit doccia, flessibile 150 cm.
Exposed bath mixer with waterfall spout, with shower kit, flexible 150 cm.

CR



CW600

Miscelatore vasca esterno con bocca a cascata, con kit doccia, flessibile 120 cm.
Exposed bath mixer with waterfall spout, with shower kit, flexible 120 cm.

CR



CW600H

Miscelatore vasca esterno con bocca a cascata, senza kit doccia.
Exposed bath mixer with waterfall spout, without shower kit.

CR





C47050

CEILING COLUMNS

Le bocche e i miscelatori con installazione a soffitto aprono a nuove possibilità di progettazione degli spazi nel design di abitazioni ed ambienti commerciali. Entrambe le soluzioni sono disponibili in diverse misure e personalizzabili con i colori di finitura. Per atmosfere più suggestive ad alto potere rilassante, tra le COLONNE A SOFFITTO sono disponibili i modelli con cartuccia led integrata: una morbida luce colorata illuminerà il fluire dell'acqua conferendo all'ambiente un carattere unico.

Ceiling-mounted spouts and mixers open up new design possibilities in home and commercial interiors. Both solutions are available in different sizes and can be customized with the finishing colours. For evocative highly relaxing interiors, the CEILING COLUMNS section also includes models with integrated LED cartridge: a soft colored light will illuminate the flow of water enhancing the room with a unique character.



CEILING COLUMNS

SL204706C



CARATTERISTICHE TECNICHE:

La serie è dotata di cartuccia a dischi ceramici, Ø 35 mm, prodotta da S.T.S.R. – Studio Tecnico Sviluppo e Ricerche - www.stsr.it

TECHNICAL FEATURES:

The series is equipped with ceramic cartridge, Ø 35 mm, produced by S.T.S.R. - Research Development Technical Office - www.stsr.it



SL204706C

MISCELATORE DA SOFFITTO - CEILING MIXER



Miscelatore da soffitto in ottone cromato, con miscelazione e controllo flusso integrati nella bocca di erogazione. Con dispositivo color.
Ceiling mixer in chrome plated brass, with mixing and flow control integrated in the outlet spout. With colour device.



Miscelatore da soffitto in ottone cromato, con miscelazione e controllo flusso integrati nella bocca di erogazione.
Ceiling mixer in chrome plated brass, with mixing and flow control integrated in the outlet spout.

SL20703C ●●●●●●●●

lunghezza 166 cm e dispositivo color. Performance led modalità "C".
length 166 cm and colour device. Led performance "C" mode.

CR FIN A FIN B

S20703

lunghezza 166 cm.
length 166 cm.

CR FIN A FIN B

SL20703XC ●●●●●●●●

lunghezza 181 cm e dispositivo color. Performance led modalità "C".
length 181 cm and colour device. Led performance "C" mode.

CR FIN A FIN B

S20703X

lunghezza 181 cm.
length 181 cm.

CR FIN A FIN B

SL20703XLC ●●●●●●●●

lunghezza 231 cm e dispositivo color. Performance led modalità "C".
length 231 cm and colour device. Led performance "C" mode.

CR FIN A FIN B

S20703XL

lunghezza 231 cm.
length 231 cm.

CR FIN A FIN B

BOCCHE - SPOUTS



Bocca da soffitto in ottone cromato con dispositivo color.
Ceiling spout in chrome plated brass with colour device.



Bocca da soffitto in ottone cromato.
Ceiling spout in chrome plated brass.

SL204706C 

lunghezza 166 cm e dispositivo color. Performance led modalità "C".
length 166 cm and colour device. Led performance "C" mode.

CR FIN A FIN B

S204706

lunghezza 166 cm.
length 166 cm.

CR FIN A FIN B

SL204706XC 

lunghezza 181 cm e dispositivo color. Performance led modalità "C".
length 181 cm and colour device. Led performance "C" mode.

CR FIN A FIN B

S204706X

lunghezza 181 cm.
length 181 cm.

CR FIN A FIN B



La cartuccia COLOR LED è disponibile in 2 diversi modelli tra cui scegliere in base alla prestazione del led preferita.

Nota: in fase di ordine la lettera finale del codice articolo definisce il modello di cartuccia COLOR LED inclusa.

The COLOR LED cartridge is available in 2 different models to choose from based on the preferred LED performance.

Note: when ordering, the final letter in the item code defines the COLOR LED cartridge model included.

C

Il colore della luce cambia con la temperatura dell'acqua (Blu: fino a 28°, Verde: da 28°a 33°, Giallo: da 33°a 38°, Rosso: da 38°).
Le temperature indicate possono variare di circa +/-2 gradi.

The color of the light changes following the water temperature (Blue: up to 28°, Green: from 28° to 33°, Yellow: from 33° to 38°, Red: from 38°).
Temperatures may vary by approximately +/- 2 degrees.



D

8 colori e sfumature si alternano in un continuo arcobaleno, indipendentemente dalla temperatura.

8 colors and shades alternate in a continuous rainbow, regardless of the temperature.





PUBLIC & COMMERCIAL



SEN30026

SENSOR

pag 350

TEMPOR TOUCH

pag 360

TEMPOR

pag 364

SENSOR

Le linee di rubinetteria a sensore Daniel si distinguono per eleganza e prestazioni. L'eleganza delle linee è garantita dall'accurato studio di design che sta alla base di ogni sviluppo. L'ingegnerizzazione e produzione viene eseguita interamente in Italia dagli ingegneri e tecnici del Gruppo Daniel, tramite macchinari di ultimissima generazione, completamente automatizzati e robotizzati. Ogni pezzo è un gioiello di design e tecnologia delle costruzioni. L'elettronica viene prodotta anch'essa in Italia da S.T.S.R.

The sensor taps series of Daniel are distinguished by their elegance and performance. The elegance of the lines is guaranteed by the accurate design at the base of any development. The engineering and manufacturing are performed entirely in Italy by engineers and technicians of Daniel Group, through machinery of the latest generation, fully automated and robotized. Every single piece is a jewel of design and construction technology. The electronics and sensors are also produced in Italy from S.T.S.R.





SEN30014B



ALIMENTAZIONE BATTERIA - BATTERY POWER SUPPLY

LITHIUM

Pressione di lavoro: 1 --> 6 Bar

Temperatura acqua: 65° C max

Diametro di entrata: Ø G 1/2 M

Raggio d'azione di riconoscimento: 10 cm circa, predisposto

Alimentazione elettrica: 4 batterie litio da 1,5 V tipo AA

Portabatterie adesivizzabile IPX5

Conessioni IPX5

Working pressure: 1-6 Bar

Water temperature max: 65° C max

Input: Ø G 1/2 M

Recognition range: about 10 cm adjustable

Electrical connection: 4 lithium 1,5 V batteries type AA

Adhesive Battery Holder IPX5

IPX5 connections

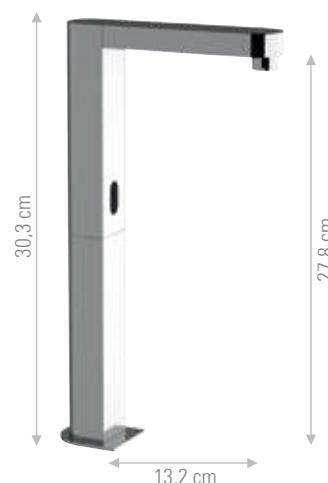
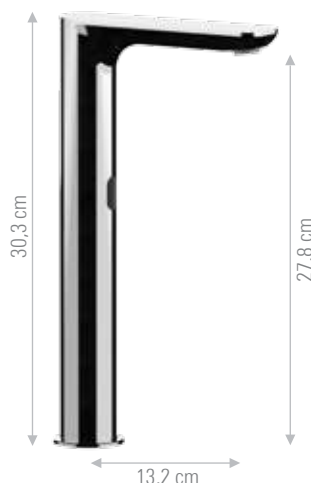

SEN30026

Rubinetto elettronico ad azionamento a sensore, **mono-acqua** dotato di rubinetto sottolavabo con filtro, alimentato a batterie al litio.

Electronic single water tap, with sensor control, equipped with angle valve with filter, powered by lithium batteries.

CR

SEN30026L

Rubinetto alto elettronico ad azionamento a sensore, **mono-acqua** dotato di rubinetto sottolavabo con filtro, alimentato a batterie al litio.

Electronic high single water tap, with sensor control, equipped with angle valve with filter, powered by lithium batteries.

CR

SEN30017L

Rubinetto elettronico alto per lavabo con azionamento a sensore, dotato di due rubinetti sottolavabo con filtro. **Per acqua premiscelata**, alimentato a batterie al litio.

High electronic tap, with sensor control, equipped with two angle valves with filter. For pre-mixed water, powered by lithium batteries.

CR

SEN30027

Rubinetto elettronico ad azionamento a sensore **con regolazione acqua caldo/ freddo** tramite due rubinetti sottolavabo con filtro, alimentato a batterie al litio.

Electronic tap, with sensor control, for pre-mixed water equipped with two angle valves with filter, powered by lithium batteries.

CR

SEN30027L

Rubinetto alto elettronico ad azionamento a sensore **con regolazione acqua caldo/ freddo** tramite due rubinetti sottolavabo con filtro, alimentato a batterie al litio.

Electronic high tap, with sensor control, for pre-mixed water equipped with two angle valves with filter, powered by lithium batteries.

CR

SEN30016L

Rubinetto elettronico alto per lavabo con azionamento a sensore, dotato di due rubinetti sottolavabo con filtro. **Per mono-acqua**, alimentato a batterie al litio.

High electronic tap, with sensor control, equipped with two angle valves with filter. For single water, powered by lithium batteries.

CR



SEN30017

Rubinetto elettronico per lavabo con azionamento a sensore, dotato di due rubinetti sottolavabo con filtro. **Per acqua premiscelata**, alimentato a batterie al litio.
Electronic tap, with sensor control, equipped with two angle valves with filter. For pre-mixed water, powered by lithium batteries.

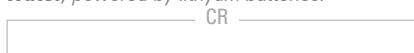

SEN30014

Rubinetto elettronico ad azionamento a sensore, alimentato a batterie al litio.
Sensor control basin mixer, powered by lithium batteries.

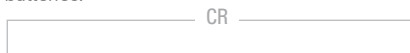

SEN30014B

Rubinetto elettronico ad azionamento a sensore, alimentato a batterie al litio.
Sensor control basin mixer with basis, powered by lithium batteries.



SEN30016

Rubinetto elettronico per lavabo con azionamento a sensore, dotato di due rubinetti sottolavabo con filtro. **Per mono-acqua**, alimentato a batterie al litio.
Electronic tap, with sensor control, equipped with two angle valves with filter. For single water, powered by lithium batteries.



SEN30014HC

Miscelatore elettronico ad azionamento a sensore **con regolazione acqua caldo/freddo**, alimentato a batterie al litio.
Sensor control basin mixer with hot/cold water adjustment lever, powered by lithium batteries.



SEN30014BHC

Miscelatore elettronico ad azionamento a sensore **con regolazione acqua caldo/freddo** con basetta, alimentato a batterie al litio.
Sensor control basin tap with hot/cold water adjustment lever with base plate, powered by lithium batteries.



SEN30018

Miscelatore elettronico ad azionamento a sensore con regolazione acqua caldo/freddo tramite leva di miscelazione laterale, alimentato a batterie al litio.
Sensor control basin mixer with hot/cold water adjustment by side mixing lever, powered by lithium batteries.

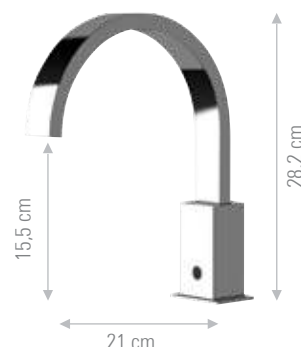

SEN30025

Miscelatore elettronico ad azionamento a sensore con regolazione acqua caldo/freddo tramite rubinetto sottolavabo, alimentato a batterie al litio.
Sensor control basin mixer with angle valve for temperature adjustment, powered by lithium batteries.

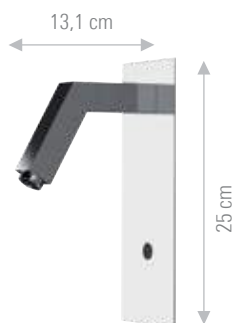

SEN634Q

Rubinetto lavabo ad incasso a sensore, monoacqua o premiscelata, alimentato a batterie al litio.
Built in wash basin sensor mixer, single water or premixed, powered by lithium batteries

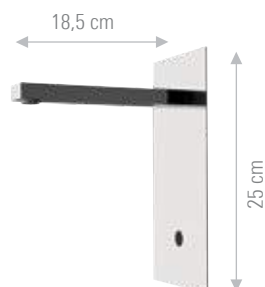

SEN634SK

Rubinetto lavabo ad incasso a sensore, monoacqua o premiscelata, alimentato a batterie al litio.
Built in wash basin sensor mixer, single water or premixed, powered by lithium batteries



ALIMENTAZIONE ELETTRICA - ELECTRIC POWER SUPPLY



Pressione di lavoro: 1 --> 6 Bar

Temperatura acqua: 65° C max

Diametro di entrata: Ø G 1/2 M

Raggio d'azione di riconoscimento: 10 cm circa, predisposto

2 modalità di funzionamento selezionabili (basso consumo/alta reattività)

Omologazione CE

Connessioni IP67

Working pressure: 1-6 Bar

Water temperature max: 65° C max

Input: Ø G 1/2 M

Recognition range: about 10 cm adjustable

2 selectable operation modes (low-consumption/high reactivity)

CE approved

IP67 connections



SEN30126

Rubinetto elettronico ad azionamento a sensore, **mono-acqua** dotato di rubinetto sottolavabo con filtro, ad alimentazione elettrica. *Electronic **single water** tap, with sensor control, equipped with angle valve with filter, powered by electricity.*

CR

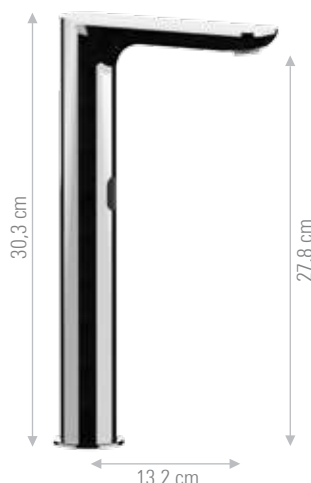
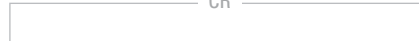

SEN30126L

Rubinetto alto elettronico ad azionamento a sensore, **mono-acqua** dotato di rubinetto sottolavabo con filtro, ad alimentazione elettrica. *Electronic high **single water** tap, with sensor control, equipped with angle valve with filter, powered by electricity.*

CR

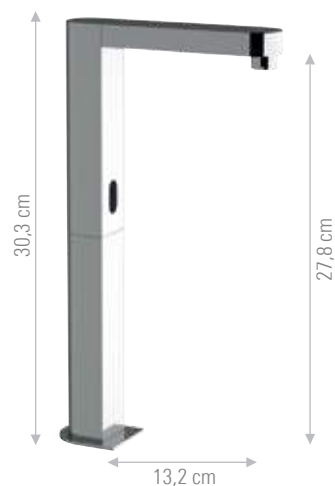

SEN30117L

Rubinetto elettronico alto per lavabo con azionamento a sensore, dotato di due rubinetti sottolavabo con filtro. **Per acqua premiscelata**, ad alimentazione elettrica. *High electronic tap, with sensor control, equipped with two angle valves with filter. For pre-mixed water, powered by electricity.*

CR



SEN30127

Rubinetto elettronico ad azionamento a sensore **con regolazione acqua caldo/ freddo** tramite due rubinetti sottolavabo con filtro, ad alimentazione elettrica. *Electronic tap, with sensor control, for **pre-mixed water** equipped with two angle valves with filter, powered by electricity.*

CR

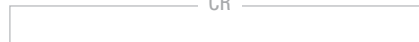

SEN30127L

Rubinetto alto elettronico ad azionamento a sensore **con regolazione acqua caldo/ freddo** tramite due rubinetti sottolavabo con filtro, ad alimentazione elettrica. *Electronic high tap, with sensor control, for **pre-mixed water** equipped with two angle valves with filter, powered by electricity.*

CR



SEN30116L

Rubinetto elettronico alto per lavabo con azionamento a sensore, dotato di due rubinetti sottolavabo con filtro. **Per mono-acqua**, ad alimentazione elettrica. *High electronic tap, with sensor control, equipped with two angle valves with filter. For single water, powered by electricity.*

CR





SEN30117

Rubinetto elettronico per lavabo con azionamento a sensore, dotato di due rubinetti sottolavabo con filtro. **Per acqua premiscelata**, ad alimentazione elettrica.
Electronic tap, with sensor control, equipped with two angle valves with filter.
For pre-mixed water, powered by electricity.

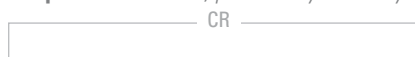

SEN30116

Rubinetto elettronico per lavabo con azionamento a sensore, dotato di due rubinetti sottolavabo con filtro. **Per mono-acqua**, ad alimentazione elettrica.
Electronic tap, with sensor control, equipped with two angle valves with filter.
For single water, powered by electricity.



SEN30118

Miscelatore elettronico ad azionamento a sensore con regolazione acqua caldo/freddo tramite leva di miscelazione laterale, ad alimentazione elettrica.
Sensor control basin mixer with hot/cold water adjustment by side mixing lever, powered by electricity.



SEN30117

LUCE LED A COLORI - COLOR LED LIGHT



Pressione di lavoro: 1 --> 6 Bar
Temperatura acqua: 65° C max
Diametro di entrata: Ø G 1/2 M
Raggio d'azione di riconoscimento: 10 cm circa, predisposto
Portabatterie adesivizzabile IPX5
Connessioni IPX5

Working pressure: 1-6 Bar
Water temperature max: 65° C max
Input: Ø G 1/2 M
Recognition range: about 10 cm adjustable
Adhesive Battery Holder IPX5
IPX5 connections



SENL30018C ●●●●●●●●

Miscelatore elettronico lavabo ad azionamento a sensore, con luce led e con regolazione acqua calda/fredda, alimentato a batterie al litio. Performance led modalità "C".
Sensor control basin mixer, with led light and with hot/cold water adjustment lever, powered by lithium batteries. Led performance "C" mode.



SENL30118C ●●●●●●●●

Miscelatore elettronico lavabo ad azionamento a sensore, con luce led e con regolazione acqua calda/fredda, ad alimentazione elettrica. Performance led modalità "C".
Sensor control basin mixer, with led light and with hot/cold water, adjustment lever, powered by electricity. Led performance "C" mode.

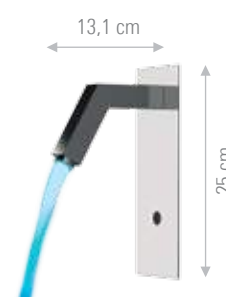

SENL634QC ●●●●●●●●

Rubinetto lavabo ad incasso a sensore, monoacqua o premiscelata, con luce led, alimentato a batterie al litio. Performance led modalità "C".
Built in wash basin sensor mixer, single water or premixed, with led light, powered by lithium batteries. Led performance "C" mode.



RUBINETTERIA A SENSORE CON LUCE LED

Nei modelli di rubinetteria a sensore con luce LED di Daniel Rubinetterie, la funzionalità della tecnologia a infrarossi viene personalizzata da un'originale luce led colorata.

Grazie alla speciale cartuccia COLOR LED all'interno del miscelatore, infatti, il semplice passaggio dell'acqua genera una delicata multi colore che ne accompagna il fluire e che si diffonde nello spazio circostante. Questi prodotti non richiedono batterie o alimentazione elettrica ed includono tutta l'elettronica e la componentistica necessarie al funzionamento.

La cartuccia COLOR LED è disponibile in 2 diversi modelli tra cui scegliere in base alla prestazione del led preferita.
 Nota: in fase di ordine la lettera finale del codice articolo definisce il modello di cartuccia COLOR LED inclusa.

C Il colore della luce cambia con la temperatura dell'acqua (Blu: fino a 28°, Verde: da 28° a 33°, Giallo: da 33° a 38°, Rosso: da 38°).
The color of the light changes following the water temperature (Blue: up to 28°, Green: from 28° to 33°, Yellow: from 33° to 38°, Red: from 38°).



D 8 colori e sfumature si alternano in un continuo arcobaleno, indipendentemente dalla temperatura.
8 colors and shades alternate in a continuous rainbow, regardless of the temperature.



Le temperature indicate possono variare di circa +/- 2 gradi.

SENSOR TAPS WITH LED LIGHT

In the sensor faucets with LED light by Daniel Rubinetterie, the performance of the infrared technology is featured by an original coloured LED light.

Thanks to the special COLOR LED cartridge included in the mixer, the simple passage of water generates a delicate multi-coloured light that follows the flow and illuminates all around the basin. These products do not require batteries or electrical power and include all the electronics and components necessary for operation.

The COLOR LED cartridge is available in 2 different models to choose from based on the preferred LED performance. Note: when ordering, the final letter in the item code defines the COLOR LED cartridge model included.

Temperatures may vary by approximately +/- 2 degrees.



SEN30033

Rubinetto esterno elettronico per orinatoio.
External urinal electronic flusher.



CR

Pressione di lavoro: 1 – 6 Bar
Diametro di entrata: G1/2
Raggio d'azione di riconoscimento: 35 cm, predisposto.
Alimentazione elettrica: DC 6V quattro batterie alcaline "AAA" da 1.5V
Modalità di installazione: esterno

Working pressure: 1-6 Bar

Input: Ø G 1/2

Recognition range: 35 cm adjustable

Electrical connection: DC 6V with 4 1,5 V alkaline batteries type AAA

Installation: external mounted



SEN30030

Rubinetto ad incasso elettronico per orinatoio.
Built-in urinal electronic flusher.



CR

Pressione di lavoro: 1 – 6 Bar
Diametro di entrata: G1/2
Azionamento: elettrovalvola integrata
Raggio d'azione di riconoscimento: 30 – 60 cm, regolabile
Alimentazione elettrica: DC 4.5V tre batterie alcaline "AAA" da 1.5V
Installazione: montaggio ad incasso.

Working pressure: 1-6 Bar

Input: Ø G 1/2

Control valve: solenoid valve

Recognition range: 30-60 cm adjustable

Electrical connection: DC 4.5 V with 3 1,5 V alkaline batteries type AAA

Installation: built-in



SEN30071

Dispenser a sensore per sapone liquido e liquido disinfettante.
Sensor dispenser for liquid soap and liquid disinfectant.



CR

Capacità: 650 ml
Batteria: 6 x 1,5 V

Capacity: 650 ml
Battery: 6 x 1,5 V

SENPKIT

Kit composto da: connettore per alimentazione elettrica dei dispositivi elettronici, con commutazione automatica a batteria in caso di mancanza energia elettrica ed alimentatore a 6V, in scatola (da utilizzare con batterie alcaline).

Kit composed of: power supply jointer with battery back-up function and power supply 6V, in box (for use with alkaline batteries).

CR



TEMPOR TOUCH

TEMPOR TOUCH è una soluzione elettronica per i rubinetti a flusso temporizzato. Una performance hi-tech per controllare i consumi di acqua nei bagni ad uso pubblico e negli esercizi commerciali.

*TEMPOR TOUCH is an electronic solution for timed flow taps.
A hi-tech performance to control water consumption in public and commercial restrooms.*



TEMPOR TOUCH

TECNOLOGIA PIEZO

La temporizzazione elettronica dei rubinetti TEMPOR TOUCH si avvale della tecnologia PIEZO. L'erogazione dell'acqua si attiva tramite la pressione di un pulsante piezoelettrico e si interrompe automaticamente dopo un periodo prestabilito o con una seconda pressione del tasto.

La versione a due tempi permette all'utente di selezionare la durata del flusso prima della apertura della valvola: 1 pressione per un flusso di 10 secondi oppure 2 pressioni consecutive per un flusso di circa 20 secondi. Ogni pressione del tasto è confermata da un feedback ottico dato dalla contestuale accensione di un indicatore a luce led.

La tecnologia PIEZO aumenta il livello di precisione e sicurezza dei rubinetti temporizzati e assicura le prestazioni desiderate anche su installazioni multiple e/o in linea.

VERSIONE 1 TEMPO

Impostazione di fabbrica a 10 secondi circa.
Erogazione istantanea a fronte della pressione del tasto.
Attivazione luce led a 1 colore.

VERSIONE 2 TEMPI

Impostazione di fabbrica a 10 secondi circa per 1 pressione e a 20 secondi circa per 2 pressioni consecutive.
Erogazione con ritardo di circa 1,5 secondi per permettere all'utente di effettuare l'eventuale seconda pressione.
Attivazione luce led a 2 colori in base alla temporizzazione scelta.

PIEZO TECHNOLOGY

The electronic timing of TEMPOR TOUCH taps uses PIEZO technology. The water supply is activated by pressing a piezoelectric button and stops automatically after a pre-set period or with a second pressure of the button.

The two-time version allows the user to select the duration of the flow before the valve opens: 1 press for a flow of 10 seconds or 2 consecutive presses for a flow of approximately 20 seconds. Each press is confirmed by an optical feedback given by the simultaneous switching on of a LED light marker.

PIEZO technology increases the level of precision and safety of timed taps and ensures the desired performance even on multiple and/or in-line installations.

1 TIMING VERSION

*Factory setting at approximately 10 seconds.
Instant water delivery upon pressing the button.
1 color led light activation.*

2 TIMING VERSION

*Factory setting at approximately 10 seconds for 1 pressure and at approximately 20 seconds for 2 consecutive pressures.
Water delivery with a delay of about 1,5 seconds to allow the user to make a second pressure, if necessary.
2-color LED light activation based on the chosen timing.*



LAVABO ELETTRONICO TEMPORIZZATO - TEMPORIZED ELECTRONIC TAP

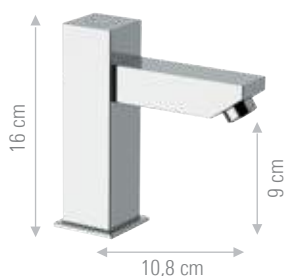

TEMT17

Rubinetto a temporizzazione elettronica con attivazione tramite pulsante ad azionamento piezoelettrico alimentato a batteria, minimale quadrato, in ottone cromato, tempo d'apertura circa 10 secondi.

Electronic timing pillar tap with piezoelectric activation button, batteries powered, minimal squared shape, all in c.p. brass, opening time about 10 seconds.

CR



TEMT10

Rubinetto a temporizzazione elettronica con attivazione tramite pulsante ad azionamento piezoelettrico alimentato a batteria, minimale tondo, in ottone cromato, tempo d'apertura circa 10 secondi.

Electronic timing pillar tap with piezoelectric activation button, batteries powered, minimal round shape, all in c.p. brass, opening time about 10 seconds.

CR

TEMT217

Rubinetto a temporizzazione elettronica con attivazione tramite pulsante ad azionamento piezoelettrico alimentato a batteria, minimale quadrato, in ottone cromato, **a due tempi d'apertura**: primo tempo circa 10 secondi, secondo tempo circa 20 secondi.

*Electronic timing pillar tap with piezoelectric activation button, batteries powered, minimal squared shape, all in c.p. brass, **two times opening**: first time opening about 10 seconds, second time about 20 seconds.*

CR

TEMT210

Rubinetto a temporizzazione elettronica con attivazione tramite pulsante ad azionamento piezoelettrico alimentato a batteria, minimale tondo, in ottone cromato, **a due tempi d'apertura**: primo tempo 10 secondi, secondo tempo 20 secondi.

*Electronic timing pillar tap with piezoelectric activation button, batteries powered, minimal round shape, all in c.p. brass, **two times opening**: first time opening about 10 seconds, second time about 20 seconds.*

CR



TEMPOR

TEMPOR è una linea di rubinetti a flusso temporizzato con pressione meccanica per interrompere autonomamente il flusso dell'acqua dopo un tempo determinato, garantendo il controllo sul consumo di acqua in ambienti pubblici.

TEMPOR is a line of timed flow taps with mechanical pressure to autonomously stop the water flow after a specific time, ensuring control over water consumption in public places.



TEMPOR

TEM40010

LAVABI - WASHBASIN MIXERS



TEM40010

Rubinetto temporizzato 1/2" in ottone cromato tempo d'apertura 6-8 secondi.
Temporized tap 1/2 all in Cp brass opening time 6-8 seconds.

11 cm



TEM40010M

Rubinetto miscelatore temporizzato a collo di cigno con maniglia per la selezione dell'acqua calda/fredda, 1/2" in ottone cromato, tempo di apertura 6-8 secondi.
Temporized mixer pillar tap with hot/cold water selection handle, in c.p. brass, opening time 6-8 seconds.

11 cm



TEM40225

Rubinetto a muro temporizzato 1/2" in ottone cromato tempo d'apertura 6-8 secondi.
Temporized frontal mounted 1/2 tap all in Cp brass, opening time 6-8 seconds.

12 cm



TEM40053

Rubinetto frontale temporizzato, con canna "S", 1/2", in ottone, tempo d'apertura 6-8 secondi.
Temporized (timer) frontal mounted, with "S" spout, 1/2" tap, all in brass, opening time 6-8 seconds.

23 cm



TEM40041M

Miscelatore a muro temporizzato per lavello con canna girevole.
Wall mounted temporized sink mixer, with movable spout.

23 cm

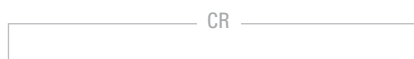

TEM40053U

Rubinetto superiore temporizzato, con canna "U", 1/2", in ottone, tempo d'apertura 6-8 secondi.
Temporized (timer) upper mounted, with "U" spout, 1/2" tap, all in brass, opening time 6-8 seconds.

18 cm



TEM40053J

Rubinetto superiore temporizzato, con canna "J", 1/2", in ottone, tempo d'apertura 6-8 secondi.
Temporized (timer) upper mounted, with "J" spout, 1/2" tap, all in brass, opening time 6-8 seconds.

18 cm



TEM40001

Cartuccia di ricambio per TEM40015, TEM40016, TEM40225, TEM40855, TEM40053.
Cartridge for temporized taps for TEM40015, TEM40016, TEM40225, TEM40855, TEM40053.

CR



TOILET

**TEM40171**

Flussometro temporizzato a incasso, a pulsante, per wc, 3/4, 1", tempo d'apertura 6-8 secondi.

Temporized (timer) built-in tap, for wc, 3/4, 1", opening time 6-8 seconds.

CR

**TEM40171Q**

Flussometro temporizzato a incasso quadrato a pulsante per wc, 3/4, 1", tempo d'apertura 6-8 secondi.

Temporized (timer) built-in squared tap for wc, 3/4, 1", opening time 6-8 seconds.

CR

**TEM40170**

Flussometro temporizzato a pulsante esterno per WC, in ottone, tempo d'apertura 6-8 secondi, misure: 3/4, 1".

Temporized (timer) wall mounted tap, for wc, all in brass, opening time 6-8 seconds: 3/4, 1".

CR

**1000TEM**

Set composto da: doccia a pulsante, flessibile conico cm 120, rubinetto temporizzato 1/2" in ottone, tempo d'apertura 6-8 secondi.

Set composed of: shut-off handshower, flexible cm 120, temporized button flusher 1/2" all in brass, opening time 6-8 seconds.

CR

**TEM40855**

Rubinetto temporizzato a pulsante per orinatoio, 1/2", in ottone, completo di rosoni, di due tubetti Ø mm 14 e guarnizione. Tempo d'apertura 6-8 secondi.

Temporized (timer) urinal button flusher, 1/2", in brass, in a set with flanges, two copper tubes Ø mm 14 and a washer. Opening time 6-8 seconds.

CR



Tubo a "L" per flussometro esterno, in ottone, Ø 25, 30.

"L" brass pipe, for wall mounted tempor tap for wc, Ø 25, 30.

TEM40170TB25

Ø 25

CR

TEM40170TB30

Ø 30

CR

**A1515TEM**

Set composto da: idroscopino a pulsante in ottone, flessibile conico cm 120, rubinetto temporizzato 1/2" in ottone, tempo d'apertura 6-8 secondi.

Set composed of: hydro brush in brass, flexible cm 120, temporized button flusher 1/2" all in brass, opening time 6-8 seconds.

CR

**A40860**

Spartiacque per orinatoio, attacco Ø 15, con tubo Ø 15 mm.

Water divide for urinals, connection Ø 15, with pipe Ø 15 mm.

CR

DOCCIA - SHOWER MIXERS



TEM40053AS

Rubinetto frontale temporizzato, colonna doccia 1/2" x 3/4" e soffione doccia standard, tempo d'apertura 6-8 secondi.
Temporized (timer) frontal mounted, with stand pipe 1/2" x 3/4" and standard shower head, opening time 6-8 seconds.

CR



TEM40032M

Miscelatore doccia temporizzato da incasso.
Built-in timerized shower mixer.

CR



TEM40030M

Miscelatore doccia temporizzato da incasso.
Built-in timerized shower mixer.

CR



TEM40030

Rubinetto per doccia incasso temporizzato, 1/2", tempo d'apertura 18-20 secondi.
Temporized (timer) wall mounted tap, 1/2", opening time 18-20 seconds.

CR



TEM40035

Rubinetto temporizzato a pulsante per doccia esterno, 1/2"x1/2", in ottone, tempo d'apertura 18-20 secondi.
Temporized (timer) tap for shower, 1/2"x1/2", external, all in brass, opening time 18-20 seconds.

CR



TEM40030Q

Rubinetto per doccia incasso temporizzato quadrato, 1/2", in ottone, tempo d'apertura 18-20 secondi.
Temporized (timer) wall mounted squared tap, 1/2", opening time 18-20 seconds.

CR



TEM40030VI

Cartuccia di ricambio per TEM40855, TEM40053.
Cartridge for timerized taps for TEM40855, TEM40053.

CR

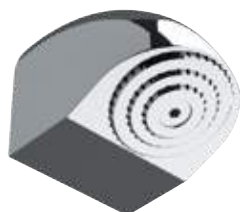

A560AVS

Soffione doccia antivandalo ed antimpiccagione con getto fisso.
Antivandal and antiligature shower head with fix spray.

CR



A560AV

Soffione doccia antivandalo ed antimpiccagione con getto regolabile.
Antivandal and antiligature shower head with adjustable spray.

CR



WELLNESS



BOX INCASSO - <i>BUILT-IN BOX</i>	pag 372
WELLNESS KIT	pag 382
CROMOTERAPIA - <i>COLOURTHERAPY</i>	pag 396
SOFFIONI A SOFFITTO - <i>CEILING SHOWER HEADS</i>	pag 410
SOFFIONI - <i>SHOWER HEADS</i>	pag 422
BOCCHIE - <i>SPOUTS</i>	pag 434
PANNELLI DOCCIA - <i>SHOWER PANELS</i>	pag 440
COLONNE DOCCIA - <i>SHOWER COLUMN</i>	pag 446
SALISCENDI - <i>SLIDINGRAILS</i>	pag 460
DOCCETTE - <i>HAND SHOWERS</i>	pag 466
SHUT-OFF	pag 480
OUTDOOR	pag 490

BOX INCASSO BUILT-IN BOX

La BOX INCASSO di Daniel Rubinetterie è un articolo studiato appositamente per le esigenze di cantiere. Un incasso universale, compatibile con tutte le collezioni di Daniel Rubinetterie, che permette di portare a termine i lavori di muratura senza dover attendere la scelta finale della rubinetteria da parte del Cliente.

Un servizio migliorativo per tutti i costruttori che possono ora dare alla propria clientela la possibilità di scegliere in tranquillità tra le tante varianti di rubinetteria, senza che questo interferisca con lo stato dei lavori, senza ritardi e senza compromessi nello stile progettuale. La box incasso è disponibile in 4 diversi modelli in base al numero di uscite acqua da gestire, può supportare miscelatori per doccia a fino a 3 uscite acqua e il miscelatore a incasso per lavabo.

Ogni box consente di alloggiare in un secondo momento le parti complementari di ogni collezione Daniel Rubinetterie con cartuccia sia tradizionale che termostatica, sia con diametro Ø 40 mm che Ø 35 mm. La box incasso di Daniel Rubinetterie e tutti i suoi componenti sono interamente prodotti in Italia utilizzando i migliori materiali e tecnologie produttive high-tech. La materia prima utilizzata per il contenitore della box, ad alta densità, è stata appositamente selezionata per essere pratica al taglio, durevole nel tempo, protettiva, resistente e insonorizzante. Grazie al ridotto spessore della BOX è possibile l'installazione in cartongessi e pareti in legno e rimane comunque e sempre un prodotto ispezionabile nel tempo.

BUILT-IN BOX by Daniel Rubinetterie is an item specifically designed for construction site needs. A universal built-in part, compatible with all the Daniel Rubinetterie faucet collections, which allows plant and masonry work to be completed without waiting for the final choice of faucets from customers.

An improved service for all the builders who can now give their customers the opportunity to easily choose among the many collections of faucets, without interfering with the state of the work, without any delay and without compromising on the design style. The built-in box is available with 4 different models based on the number of water outlets to be managed, it can support shower mixers with up to 3 water outlets and the built-in basin mixer.

Each box allows the complementary parts of each Daniel Rubinetterie collection to be housed at a later time with both traditional and thermostatic cartridge, with diameters of Ø 40 mm and Ø 35 mm. The Daniel Rubinetterie built-in box and all its components are entirely produced in Italy using the best materials and high-tech production technologies. The raw material used for the container of the box, with high density, has been specially selected to be easy-cutting, long-lasting, protective, resistant and soundproofing.

Thanks to the reduced thickness of the BOX, it is possible to install it in plasterboard and wooden walls and still remains a product that can be inspected over time.

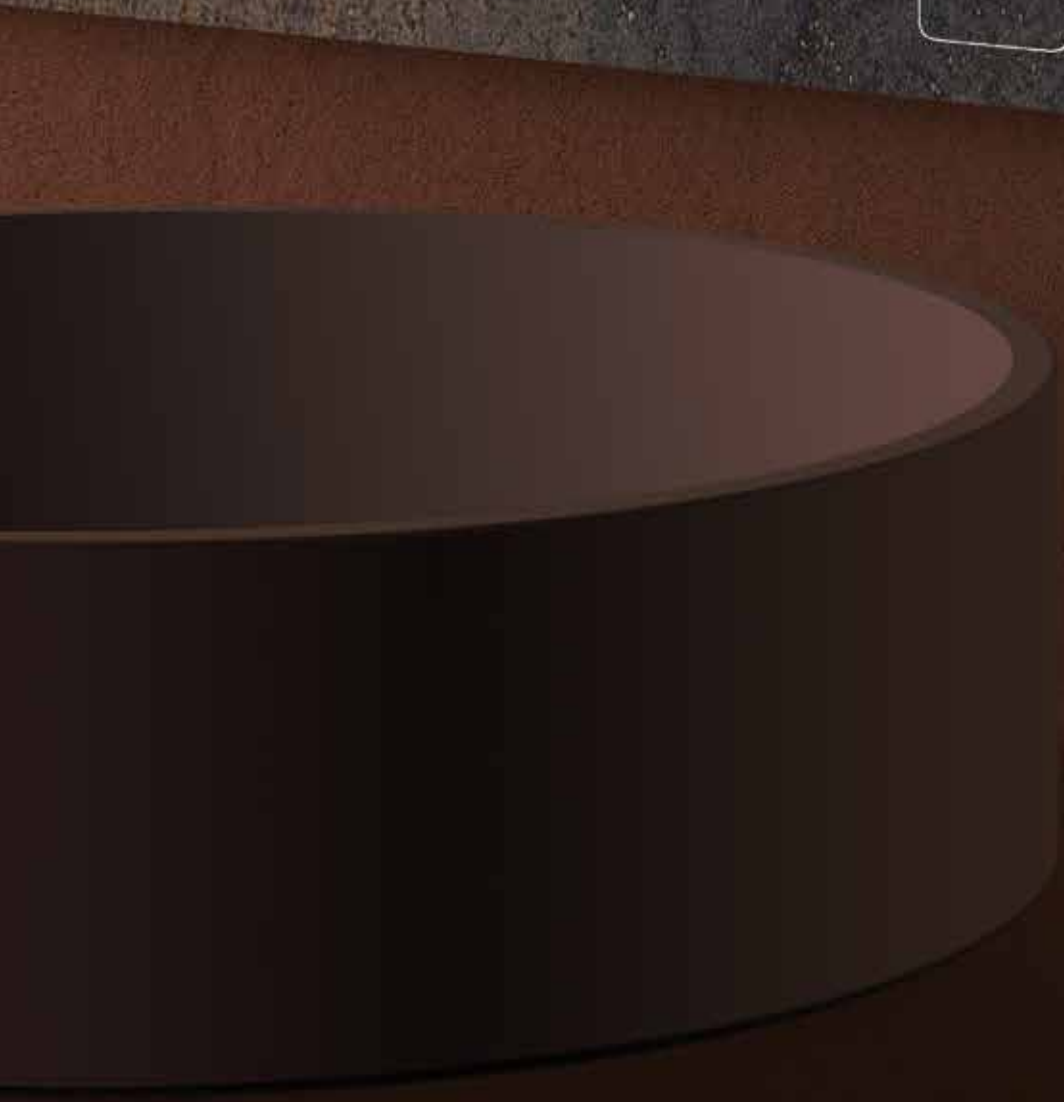
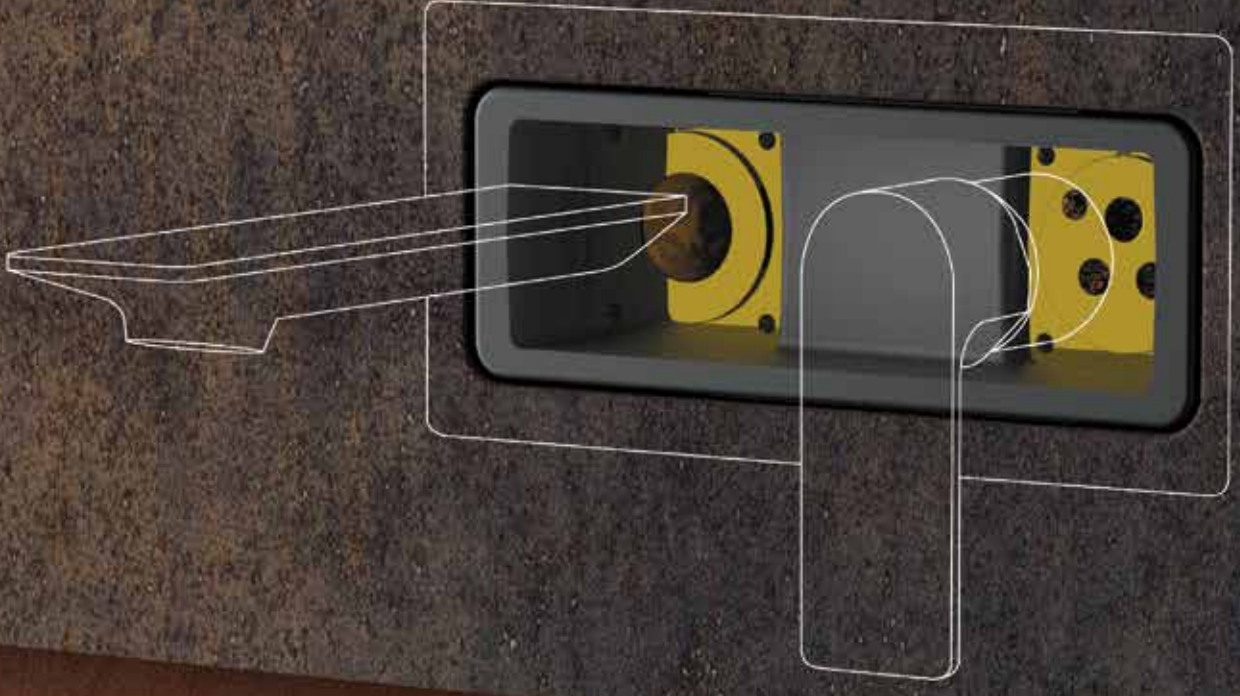

BOX A INCASSO PER MISCELATORE
DOCCIA CON 1 O NESSUNA
DEVIAZIONE

BUILT-IN BOX FOR SHOWER MIXER
WITH 1 OR NONE DEVIATION

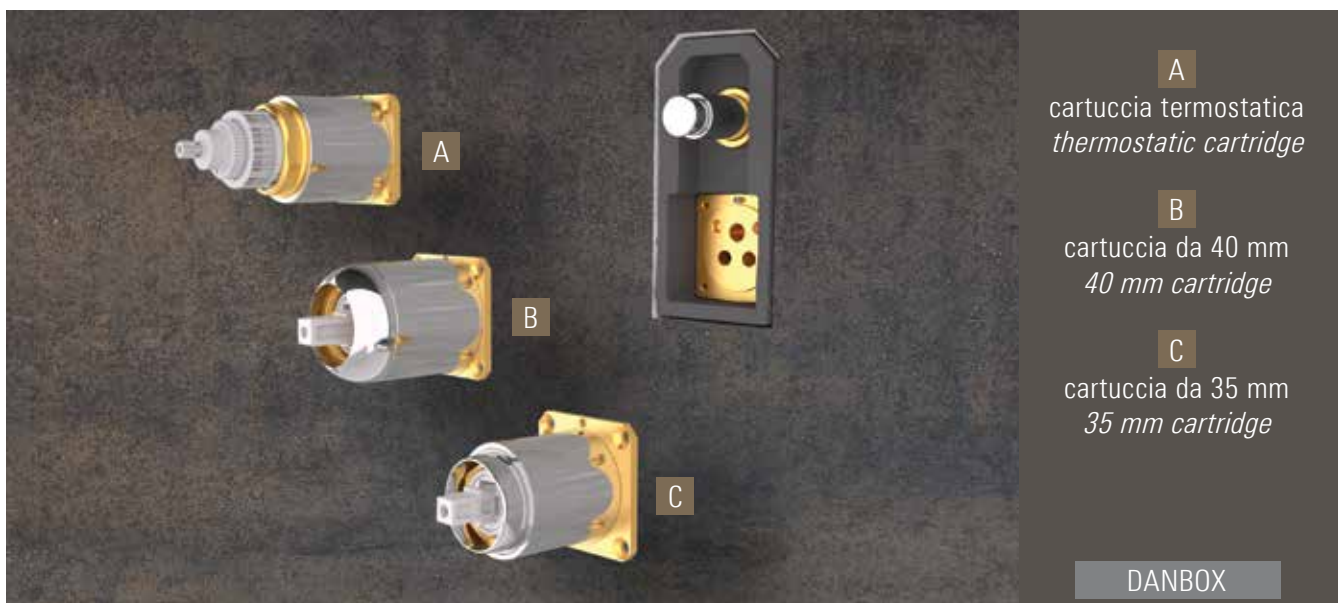

Cod. DANBOX

Box da incasso per miscelatori doccia con una o nessuna deviazione.
Built-in box for shower mixer with 1 or none deviation.

CR

Questa parte a incasso può essere abbinata a tutti i seguenti modelli di miscelatore per doccia con una o nessuna deviazione, indipendentemente dalla tipologia di cartuccia e di leva. La materia prima utilizzata per il contenitore della box, ad alta densità, è stata appositamente selezionata per essere pratica al taglio, durevole nel tempo, protettiva, resistente e insonorizzante.

This built-in part can be combined with all the following shower mixer models with 1 or none deviation, regardless of the type of cartridge and lever. The high-density raw material used for the box container has been specially selected to be easy-cutting, long-lasting, protective, resistant and soundproof.

Grazie allo spessore ridotto, è possibile l'installazione in cartongessi e pareti in legno. Dopo l'installazione, il prodotto resta facilmente ispezionabile nel tempo.

Thanks to the reduced thickness, installation in plasterboard and wooden walls is possible. After installation, the product will always be easy to inspect over time.

CARTUCCIA Ø 35 - Ø 35 CARTRIDGE

SERIE AMBITION

AI612KB **AI602KB**

FINA	FINA
FIN B	FIN B

SERIE TRILOGY

TG612KB **TG602KB**

FINA	FINA
FIN B	FIN B

SERIE TIARA

TA612KB **TA602KB**

FINA	FINA
FIN B	FIN B

SERIE TOKYO



TK612KB **TK602KB**

FINA	FINA
FIN B	FIN B

SERIE SKYLINE



SK612KB **SK602KB**

FINA	FINA
FIN B	FIN B

SERIE FUSION



FU612KB **FU602KB**

FINA	FINA
FIN B	FIN B

SERIE DIVA



DV612KB **DV602KB**

FINA	FINA
FIN B	FIN B

SERIE SPEED



SP612KB **SP602KB**

FINA	FINA
FIN B	FIN B

SERIE SWING



SG612KB **SG602KB**

FINA	FINA
FIN B	FIN B

SERIE REFLEX



RX612KB **RX602KB**

FINA	FINA
FIN B	FIN B

SERIE OMEGA



OM612KB **OM602KB**

FINA	FINA
FIN B	FIN B

SERIE SMART



SR612KB **SR602KB**

FINA	FINA
FIN B	FIN B

SERIE BROOKLYN



BY612KB **BY602KB**

FINA	FINA
FIN B	FIN B

SERIE REVIVAL



V612KB **V602KB**

FINA	FINA
FIN B	FIN B

SERIE RETRÒ



RT612KB **RT602KB**

FINA	FINA
FIN B	FIN B

CARTUCCIA TERMOSTATICA - THERMOSTATIC CARTRIDGE

SERIE CUBE WATERFALL



OX23612KB **OX23602KB**

FINA	FINA
FIN B	FIN B

SERIE SKYLINE THERMO 



SKT612KB **SKT602KB**

FINA	FINA
FIN B	FIN B

SERIE SUVI THERMO 

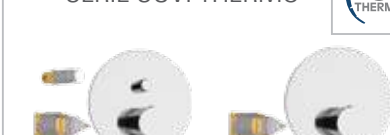

ST20612KB **ST20602KB**

FINA	FINA
FIN B	FIN B

BOX INCASSO
BUILT-IN BOX

WELLNESS
KIT

CROMOTERAPIA
COLOUR THERAPY

SOFFIONI & SOFFIONI A SOFFITTO
SHOWER HEADS & CEILING

BOCCHE
SPOUTS

PANNELLI
PANELS

COLONNE
COLUMN

SALISCENDI
SLIDING RAILS

DOCCETTE
HAND SHOWERS

OASIS
SHUT-OFF

OUTDOOR

BOX A INCASSO PER MISCELATORE
DOCCIA CON DEVIATORE A DISCHI
CERAMICI A 2 VIE

BUILT-IN BOX FOR SHOWER MIXER
WITH 2-WAY CERAMIC DISC
DIVERTER



DANBOXD2



Cod. DANBOXD2

Box da incasso per miscelatore doccia con deviatore a 2 vie.
Built-in box for shower mixer with 2- way diverter.

CR

Questa parte a incasso può essere abbinata a tutti i seguenti modelli di miscelatore per doccia a 2 vie , indipendentemente dalla tipologia di cartuccia e di leva.

La materia prima utilizzata per il contenitore della box, ad alta densità, è stata appositamente selezionata per essere pratica al taglio, durevole nel tempo, protettiva, resistente e insonorizzante. Grazie allo spessore ridotto, è possibile l'installazione in cartongessi e pareti in legno. Dopo l'installazione il prodotto resta facilmente ispezionabile nel tempo.

This built-in part can be combined with all the following shower mixer models with 2-way diverter, regardless of the type of cartridge and lever.

The high-density raw material used for the box container has been specially selected to be easy-cutting, long-lasting, protective, resistant and sound-proof. Thanks to the reduced thickness, installation in plasterboard and wooden walls is possible. After installation, the product will always be easy to inspect over time.

CARTUCCIA Ø 35 - Ø 35 CARTRIDGE

SERIE AMBITION



AI612D2KB

FINA

FIN B

SERIE TRILOGY



TG612D2KB

FINA

FIN B

SERIE TIARA



TA612D2KB

FINA

FIN B

SERIE TOKYO



TK612D2KB

FINA

FIN B

SERIE SKYLINE



SK612D2KB

FINA

FIN B

SERIE FUSION



FU612D2KB

FINA

FIN B

SERIE DIVA



DV612D2KB

FINA

FIN B

SERIE SPEED



SP612D2KB

FINA

FIN B

SERIE SWING



SG612D2KB

FINA

FIN B

SERIE REFLEX



RX612D2KB

FINA

FIN B

SERIE OMEGA



OM612D2KB

FINA

FIN B

SERIE SMART



SR612D2KB

FINA

FIN B

SERIE CUBE WATERFALL



OX23612D2KB

FINA

FIN B

CARTUCCIA TERMOSTATICA - THERMOSTATIC CARTRIDGE

SERIE SKYLINE THERMO



SKT612D2KB

FINA

FIN B

SERIE SUVI THERMO



ST20612D2KB

FINA

FIN B

BOX INCASSO
BUILT-IN BOX

WELLNESS
KIT

CROMOTERAPIA
COLOUR THERAPY

SOFFIONI & SOFFIONI A SOFFITTO
SHOWER HEADS & CEILING

BOCCHE
SPOUTS

PANNELLI
PANELS

COLONNE
COLUMN

SALISCENDI
SLIDING RAILS

DOCCETTE
HAND SHOWERS

OASIS
SHUT-OFF

OUTDOOR

BOX A INCASSO PER MISCELATORE
DOCCIA CON DEVIATORE A DISCHI
CERAMICI A 3 VIE

BUILT-IN BOX FOR SHOWER MIXER
WITH 3-WAY CERAMIC DISC
DIVERTER



DANBOXD3



Cod. DANBOXD3

Box da incasso per miscelatore doccia con deviatore a 3 vie.
Built-in box for shower mixer with 3-way diverter.

CR

Questa parte a incasso può essere abbinata a tutti i seguenti modelli di miscelatore per doccia a 3 vie, indipendentemente dalla tipologia di cartuccia e di leva.

La materia prima utilizzata per il contenitore della box, ad alta densità, è stata appositamente selezionata per essere pratica al taglio, durevole nel tempo, protettiva, resistente e insonorizzante. Grazie allo spessore ridotto, è possibile l'installazione in cartongessi e pareti in legno. Dopo l'installazione, il prodotto resta facilmente ispezionabile nel tempo.

This built-in part can be combined with all the following shower mixer models with 3-way diverter, regardless of the type of cartridge and lever.

The high-density raw material used for the box container has been specially selected to be easy-cutting, long-lasting, protective, resistant and sound-proof. Thanks to the reduced thickness, installation in plasterboard and wooden walls is possible. After installation, the product will always be easy to inspect over time.

CARTUCCIA Ø 35 - Ø 35 CARTRIDGE

SERIE AMBITION



AI612D3KB

FINA

FIN B

SERIE TRILOGY



TG612D3KB

FINA

FIN B

SERIE TIARA



TA612D3KB

FINA

FIN B

SERIE TOKYO



TK612D3KB

FINA

FIN B

SERIE SKYLINE



SK612D3KB

FINA

FIN B

SERIE FUSION



FU612D3KB

FINA

FIN B

SERIE DIVA



DV612D3KB

FINA

FIN B

SERIE SPEED



SP612D3KB

FINA

FIN B

SERIE SWING



SG612D3KB

FINA

FIN B

SERIE REFLEX



RX612D3KB

FINA

FIN B

SERIE OMEGA



OM612D3KB

FINA

FIN B

SERIE SMART



SR612D3KB

FINA

FIN B

SERIE CUBE WATERFALL



OX23612D3KB

FINA

FIN B

CARTUCCIA TERMOSTATICA - THERMOSTATIC CARTRIDGE

SERIE SKYLINE THERMO



SKT612D3KB

FINA

FIN B

SERIE SUVI THERMO



ST20612D3KB

FINA

FIN B

BOX INCASSO
BUILT-IN BOX

WELLNESS
KIT

CROMOTERAPIA
COLOUR THERAPY

SOFFIONI & SOFFIONI A SOFFITTO
SHOWER HEADS & CEILING

BOCCHE
SPOUTS

PANNELLI
PANELS

COLONNE
COLUMN

SALISCENDI
SLIDING RAILS

DOCCETTE
HAND SHOWERS

OASIS
SHUT-OFF

OUTDOOR

BOX A INCASSO PER MISCELATORE LAVABO A PARETE

BUILT-IN BOX FOR BUILT-IN BASIN MIXER.



DANBOX632



Cod. DANBOX632

Box da incasso per miscelatore lavabo con montaggio a parete.
Built-in box for wall-mounting basin mixer.

CR

Questa parte a incasso può essere abbinata a tutti i seguenti modelli di miscelatore per lavabo, indipendentemente dalla tipologia di cartuccia e di leva.

This built-in part can be combined with all the following basin mixer models, regardless of the type of cartridge and lever.

La materia prima utilizzata per il contenitore della box, ad alta densità, è stata appositamente selezionata per essere pratica al taglio, durevole nel tempo, protettiva, resistente e insonorizzante. Grazie allo spessore ridotto, è possibile l'installazione in cartongessi e pareti in legno. Dopo l'installazione, il prodotto resta facilmente ispezionabile nel tempo.

The high-density raw material used for the box container has been specially elected to be easy-cutting, long-lasting, protective, resistant and sound-proof. Thanks to the reduced thickness, installation in plasterboard and wooden walls is possible. After installation, the product will always be easy to inspect over time.

CARTUCCIA Ø 25 - Ø 25 CARTRIDGE



SERIE DIVA



DV632KB

FINA

FIN B

SERIE SPEED



SP632KB

FINA

FIN B

CARTUCCIA Ø 35 · Ø 35 CARTRIDGE

SERIE TRILOGY



TG632KB

FINA

FIN B

SERIE TIARA



TA632KB

TA632LKB

FINA

FIN B

FINA

FIN B

SERIE FUSION



FU632KB

FINA

FIN B

SERIE REFLEX



RX632KB

RX632LKB

FINA

FIN B

FINA

FIN B

SERIE OMEGA



OM632KB

OM632LKB

FINA

FIN B

FINA

FIN B

SERIE SMART



SR632KB

SR632LKB

FINA

FIN B

FINA

FIN B

SERIE CUBE WATERFALL



CW632KB

FINA

FIN B

BOX INCASSO
BUILT-IN BOX

WELLNESS
KIT

CROMOTERAPIA
COLOUR THERAPY

SOFFIONI & SOFFIONI A SOFFITTO
SHOWER HEADS & CEILING

BOCCHE
SPOUTS

PANNELLI
PANELS

COLONNE
COLUMN

SALISCENDI
SLIDING RAILS

DOCCETTE
HAND SHOWERS

OASIS
SHUT-OFF

OUTDOOR

WELLNESS KIT

I Kit Wellness sono soluzioni complete studiate per dotare la vostra doccia di tutto il comfort e lo stile che desiderate.

The Wellness Kits are complete solutions designed to provide your shower with all the comfort and style you desire.



□ □ □ KIT DOCCIA SENZA MISCELATORE - SHOWER KIT WITHOUT SHOWER MIXERS □ □ □

□ □ □ 2 VIE - 2-WAY □ □ □



SD615ZL3MPEC20

Set per doccia, composto da: attacco presa acqua a muro con supporto per doccetta, braccio a muro in ottone 30cm, soffione Ø 20 cm in abs cromato, doccetta in ABS a 4 funzioni con pulsante per il cambio dell'intensità, flessibile 150cm. Set da completare con un miscelatore a incasso con deviatore (NON incluso).

Set for shower, including: wall water connection with hand shower holder, 30cm brass wall arm, Ø 20cm abs shower head, 4-function abs hand shower with button for jets mode switching, 150cm flexible hose. Set to be completed with a built-in mixer with diverter (not included).

CR



SD615ZL3CPAD20

Set per doccia, composto da: attacco presa acqua a muro con supporto per doccetta, braccio a muro in ottone 30cm, soffione 20x20cm in abs con angoli arrotondati, doccetta in ABS a 3 funzioni con pulsante per il cambio dell'intensità, flessibile 150cm. Set da completare con un miscelatore a incasso con deviatore (NON incluso).

Set for shower, including: wall water connection with hand shower holder, 30cm brass wall arm, 20x20cm c.p. abs shower head with rounded corners, 3-function abs hand shower with button for jets mode switching, 150cm flexible hose. Set to be completed with a built-in mixer with diverter (not included).

CR



Set per doccia, composto da: attacco presa acqua a muro con supporto per doccetta, braccio a muro squadrate in ottone 30cm, soffione in abs, doccetta in ABS a 3 funzioni con pulsante per il cambio dell'intensità, flessibile 150cm. Set da completare con un miscelatore a incasso con deviatore (NON incluso).

Set for shower, including: wall water connection with hand shower holder, 30cm squared brass wall arm, abs shower head, 3-function abs hand shower with button for jets mode switching, 150cm flexible hose. Set to be completed with a built-in mixer with diverter (not included).

SD615ZQ3CPSD20Q

Con soffione doccia 20x20cm
With shower head 20x20cm

CR



Set per doccia, composto da: attacco presa acqua a muro con supporto per doccetta, braccio a muro in ottone 30cm, soffione in abs, doccetta in ABS a 4 funzioni con pulsante per il cambio dell'intensità, flessibile 150cm. Set da completare con un miscelatore a incasso con deviatore (NON incluso).

Set for shower, including: wall water connection with hand shower holder, 30cm brass wall arm, abs shower head, 4-function abs hand shower with button for jets mode switching, 150cm flexible hose. Set to be completed with a built-in mixer with diverter (not included).

SD615ZL3MP8420

Con soffione doccia Ø20cm
With shower head Ø20cm

CR

SD615ZQ3CPSD25Q

Con soffione doccia 25x25cm
With shower head 25x25cm

CR

SD615ZL3MP8425

Con soffione doccia Ø25cm
With shower head Ø25cm

CR

SD615ZQ3CPSD30Q

Con soffione doccia 30x30cm
With shower head 30x30cm

CR

SD615ZL3MP8430

Con soffione doccia Ø30cm
With shower head Ø30cm

CR



Set per doccia, composto da: attacco presa acqua a muro con supporto per doccetta, braccio a muro in ottone 30cm, soffione tondo ultra piatto in acciaio INOX lucidato a specchio, doccetta in abs a 1 funzione, flessibile 150cm. Set da completare con un miscelatore a incasso con deviatore (NON incluso).
Set for shower, including: wall water connection with hand shower holder, 30cm brass wall arm, ultra-flat round shower head in mirror-polished stainless steel, 1-function abs hand shower, 150cm flexible hose. Set to be completed with a built-in mixer with diverter (not included).

SET615ZD20

Con soffione ultrapiatto Ø20cm
 With ultra-flat shower head Ø20cm

CR	15
----	----

SET615ZD25

Con soffione ultrapiatto Ø25cm
 With ultra-flat shower head Ø25cm

CR	15
----	----

SET615ZD30

Con soffione ultrapiatto Ø30cm
 With ultra-flat shower head Ø30cm

CR	15
----	----



Set per doccia, composto da: attacco presa acqua a muro con supporto per doccetta, braccio a muro squadrate in ottone 30cm, soffione quadrato ultra piatto in acciaio INOX lucidato a specchio, doccetta quadrata in abs a 1 funzione, flessibile 150cm. Set da completare con un miscelatore a incasso con deviatore (NON incluso).
Set for shower, including: wall water connection with hand shower holder, 30cm squared brass wall arm, squared ultra-flat shower head in mirror-polished stainless steel, 1-function abs squared hand shower, 150cm flexible hose. Set to be completed with a built-in mixer with diverter (not included).

SD615ZQ4917920Q

Con soffione ultrapiatto 20x20cm
 With ultra-flat shower head 20x20cm

CR	15
----	----

SD615ZQ4917925Q

Con soffione ultrapiatto 25x25cm
 With ultra-flat shower head 25x25cm

CR	15
----	----

SD615ZQ4917930Q

Con soffione ultrapiatto 30x30cm
 With ultra-flat shower head 30x30cm

CR	15
----	----



Set per doccia, composto da: attacco presa acqua a muro con supporto per doccetta, braccio a muro in ottone 30cm, soffione tondo in abs, doccetta in abs a 1 funzione, flessibile 150cm. Set da completare con un miscelatore a incasso con deviatore (NON incluso).
Set for shower, including: wall water connection with hand shower holder, 30cm brass wall arm, round abs shower head, 1-function abs hand shower, 150cm flexible hose. Set to be completed with a built-in mixer with diverter (not included).

SD615ZL4318420

Con soffione Ø20cm
 With shower head Ø20cm

CR

SD615ZL4318425

Con soffione Ø25cm
 With shower head Ø25cm

CR

SD615ZL4318430

Con soffione Ø30cm
 With shower head Ø30cm

CR



Set per doccia, composto da: attacco presa acqua a muro con supporto per doccetta, braccio a muro squadrate in ottone 30cm, soffione quadrato in abs, doccetta quadrata in abs a 1 funzione, flessibile 150cm. Set da completare con un miscelatore a incasso con deviatore (NON incluso).
Set for shower, including: wall water connection with hand shower holder, 30cm squared brass wall arm, squared abs shower head, 1-function abs squared hand shower, 150cm flexible hose. Set to be completed with a built-in mixer with diverter (not included).

SD615ZQ491SD20Q

Con soffione 20x20cm
 With shower head 20x20cm

CR

SD615ZQ491SD25Q

Con soffione 25x25cm
 With shower head 25x25cm

CR

SD615ZQ491SD30Q

Con soffione 30x30cm
 With shower head 30x30cm

CR

BOX INCASSO
BUILT-IN BOX

WELLNESS
KIT

CROMOTERAPIA
COLOUR THERAPY

SOFFIONI & SOFFIONI A SOFFITTO
SHOWER HEADS & CEILING

BOCCHE
SPOUTS

PANNELLI
PANELS

COLONNE
COLUMN

SALISCENDI
SLIDING RAILS

DOCCETTE
HAND SHOWERS

OASIS
SHUT-OFF

OUTDOOR



Set per doccia, composto da: attacco presa acqua a muro con supporto per doccetta, braccio a muro in ottone 30cm, soffione ultra piatto tondo in acciaio INOX lucidato a specchio, doccetta in ottone a 1 funzione, flessibile 150cm.
 Set da completare con un miscelatore a incasso con deviatore (NON incluso).
Set for shower, including: wall water connection with hand shower holder, 30cm brass wall arm, ultra-flat round shower head in mirror-polished stainless steel, 1-function brass hand shower, 150cm flexible hose.
Set to be completed with a built-in mixer with diverter (not included).

SD615ZL4357820

Con soffione doccia Ø20cm
 With shower head Ø20cm

CR 15

SD615ZL4357825

Con soffione doccia Ø25cm
 With shower head Ø25cm

CR 15

SD615ZL4357830

Con soffione doccia Ø30cm
 With shower head Ø30cm

CR 15



Set per doccia, composto da: attacco presa acqua a muro con supporto per doccetta, braccio a muro in ottone 30cm, soffione ultra piatto quadrato in acciaio INOX lucidato a specchio, doccetta in ottone a 1 funzione, flessibile 150cm.
 Set da completare con un miscelatore a incasso con deviatore (NON incluso).
Set for shower, including: wall water connection with hand shower holder, 30cm brass wall arm, ultra-flat squared shower head in mirror-polished stainless steel, 1-function brass hand shower, 150cm flexible hose.
Set to be completed with a built-in mixer with diverter (not included).

SD615ZL4957920Q

Con soffione doccia 20x20cm
 With shower head 20x20cm

CR 15

SD615ZL4957925Q

Con soffione doccia 25x25cm
 With shower head 25x25cm

CR 15

SD615ZL4957930Q

Con soffione doccia 30x30cm
 With shower head 30x30cm

CR 15



Set per doccia, composto da: attacco presa acqua a muro con supporto per doccetta, braccio a muro in ottone 30cm, soffione ultra piatto in acciaio INOX lucidato a specchio, doccetta in abs a 1 funzione, flessibile 150cm.
 Set da completare con un miscelatore a incasso con deviatore (NON incluso).
Set for shower, including: wall water connection with hand shower holder, 30cm brass wall arm, ultra-flat shower head in mirror-polished stainless steel, 1-function abs hand shower, 150cm flexible hose. Set to be completed with a built-in mixer with diverter (not included).

SD615ZL4317820

Con soffione doccia Ø20cm
 With shower head Ø20cm

CR 15

SD615ZL4317825

Con soffione doccia Ø25cm
 With shower head Ø25cm

CR 15

SD615ZL4317830

Con soffione doccia Ø30cm
 With shower head Ø30cm

CR 15



Set per doccia, composto da: attacco presa acqua a muro con supporto per doccetta, braccio a muro squadrato in ottone 30cm, soffione ultra piatto in acciaio INOX lucidato a specchio, doccetta quadrata in abs a 1 funzione, flessibile 150cm. Set da completare con un miscelatore a incasso con deviatore (NON incluso).
Set for shower, including: wall water connection with hand shower holder, 30cm squared brass wall arm, ultra-flat 20x20cm shower head in mirror-polished stainless steel, 1-function abs squared hand shower, 150cm flexible hose.
Set to be completed with a built-in mixer with diverter (not included).

SD615ZQ4917920Q

Con soffione doccia 20x20cm
 With shower head 20x20cm

CR 15

SD615ZQ4917925Q

Con soffione doccia 25x25cm
 With shower head 25x25cm

CR 15

SD615ZQ4917930Q

Con soffione doccia 30x30cm
 With shower head 30x30cm

CR 15



Set per doccia, composto da: attacco presa acqua a muro con supporto per doccetta, braccio a muro in ottone 30cm, soffione ultra piatto in acciaio INOX lucidato a specchio, doccetta in ABS a 4 funzioni con pulsante per il cambio dell'intensità, flessibile 150cm. Set da completare con un miscelatore a incasso con deviatore (NON incluso).
Set for shower, including: wall water connection with hand shower holder, 30cm brass wall arm, ultra-flat Ø20cm shower head in mirror-polished stainless steel, 4-function abs hand shower with button for jets mode switching, 150cm flexible hose. Set to be completed with a built-in mixer with diverter (not included).

SD615ZL3MP7820

Con soffione doccia Ø20cm
 With shower head Ø20cm

CR 15

SD615ZL3MP7825

Con soffione doccia Ø25cm
 With shower head Ø25cm

CR 15

SD615ZL3MP7830

Con soffione doccia Ø30cm
 With shower head Ø30cm

CR 15



Set per doccia, composto da: attacco presa acqua a muro con supporto per doccetta, braccio a muro squadrate in ottone 30cm, soffione 20x20cm in ottone, doccetta quadrata in ottone a 1 funzione, flessibile 150cm. Set da completare con un miscelatore a incasso con deviatore (NON incluso).
Set for shower, including: wall water connection with hand shower holder, 30cm brass wall arm, 20x20cm brass shower head, 1-function brass hand shower, 150cm flexible hose. Set to be completed with a built-in mixer with diverter (not included).

SD615ZL3CP7720

SD615ZL3CP7720

Con soffione doccia 20x20cm
 With shower head 20x20cm

CR 15

SD615ZL3CP7725

Con soffione doccia 25x25cm
 With shower head 25x25cm

CR 15

SD615ZL3CP7730

Con soffione doccia 30x30cm
 With shower head 30x30cm

CR 15

SD615ZL3CP7725

Con soffione 20x20 cm e braccio a parete 30cm
 With shower head 20x20 cm and wall arm 30 cm.

CR FIN A FIN B

SD615ZL3CP7730

Con soffione 30x30 cm e braccio a parete 30cm
 With shower head 30x30 cm and wall arm 30 cm.

CR FIN A FIN B

SD615ZL435594CR

Con soffione 30x30 cm e braccio a parete 40cm
 With shower head 30x30 cm and wall arm 40 cm.

CR FIN A FIN B



Set per doccia, composto da: attacco presa acqua a muro con supporto per doccetta, braccio a muro in ottone 30cm, soffione in ottone, doccetta in ottone a 1 funzione, flessibile 150cm. Set da completare con un miscelatore a incasso con deviatore (NON incluso).
Set for shower, including: wall water connection with hand shower holder, 30cm brass wall arm, brass shower head, 1-function brass hand shower, 150cm flexible hose. Set to be completed with a built-in mixer with diverter (not included).

SD615ZL435594CR

Con soffione Ø20 cm e braccio a parete 30cm
 With shower head Ø20 cm and wall arm 30 cm.

CR FIN A FIN B

SD615ZL4359430CR

Con soffione Ø30 cm e braccio a parete 30cm
 With shower head Ø30 cm and wall arm 30 cm.

CR FIN A FIN B

SD615ZL4359430CR

Con soffione Ø30 cm e braccio a parete 40cm
 With shower head Ø30 cm and wall arm 40 cm.

CR FIN A FIN B

BOX INCASSO
 BUILT-IN BOX

WELLNESS
 KIT

CROMOTERAPIA
 COLOUR THERAPY

SOFFIONI & SOFFIONI A SOFFITTO
 SHOWER HEADS & CEILING

BOCCHE
 SPOUTS

PANNELLI
 PANELS

COLONNE
 COLUMN

SALISCENDI
 SLIDING RAILS

DOCCETTE
 HAND SHOWERS

OASIS
 SHUT-OFF

OUTDOOR

□ □ □ 2 VIE CON SOFFIONE A PARETE - 2-WAY WITH WALL MOUNTING SHOWER HEAD □ □ □

**SD615Z3MP566**

Set per doccia, composto da: attacco presa acqua a muro con supporto per doccetta, soffione a parete in acciaio inox lucidato a specchio, doccetta in ABS a 4 funzioni con pulsante per il cambio dell'intensità, flessibile 150cm. Set da completare con un miscelatore a incasso con deviatore (NON incluso).

Set for shower, including: wall water connection with hand shower holder, wall-mounted shower head in mirror-polished stainless steel, 4-function abs hand shower with button for jets mode switching, 150cm flexible hose. Set to be completed with a built-in mixer with diverter (not included).

CR

15

**SD615Z3CP562Q**

Set per doccia, composto da: attacco presa acqua a muro con supporto per doccetta, soffione a parete in acciaio inox lucidato a specchio, doccetta in ABS a 4 funzioni con pulsante per il cambio dell'intensità, flessibile 150cm. Set da completare con un miscelatore a incasso con deviatore (NON incluso).

Set for shower, including: wall water connection with hand shower holder, wall-mounted shower head in mirror-polished stainless steel, 4-function abs hand shower with button for jets mode switching, 150cm flexible hose. Set to be completed with a built-in mixer with diverter (not included).

CR

15

**SD615Z431564**

Set per doccia, composto da: attacco presa acqua a muro con supporto per doccetta, soffione a parete ultra-sottile in acciaio inox lucidato a specchio, doccetta in ABS a 1 funzione, flessibile 150cm. Set da completare con un miscelatore a incasso con deviatore (NON incluso).

Set for shower, including: wall water connection with hand shower holder, ultra-flat wall-mounted shower head in mirror-polished stainless steel, 1-function abs hand shower, 150cm flexible hose. Set to be completed with a built-in mixer with diverter (not included).

CR

15

**SD615Z491563Q**

Set per doccia, composto da: attacco presa acqua a muro con supporto per doccetta, soffione a parete ultra-sottile in acciaio inox lucidato a specchio, doccetta quadrata in ABS a 1 funzione, flessibile 150cm. Set da completare con un miscelatore a incasso con deviatore (NON incluso).

Set for shower, including: wall water connection with hand shower holder, ultra-flat wall-mounted shower head in mirror-polished stainless steel, 1-function squared abs hand shower, 150cm flexible hose. Set to be completed with a built-in mixer with diverter (not included).

CR

15



SD615Z3CP2CAQ

Set per doccia, composto da: attacco presa acqua a muro con supporto per doccetta, soffione a parete in acciaio inox lucidato a specchio con getto pioggia e cascata, doccetta in ABS a 3 funzioni con pulsante per il cambio dell'intensità, flessibile 150cm. Set da completare con un miscelatore a incasso a 3 vie (NON incluso).

Set for shower, including: wall water connection with hand shower holder, wall-mounted shower head in mirror-polished stainless steel with rain and waterfall jets 3-function abs hand shower with button for jets mode switching, 150cm flexible hose. Set to be completed with a 3-way built-in mixer (not included).



SD615Z3MP6CA

Set per doccia, composto da: attacco presa acqua a muro con supporto per doccetta, soffione a parete in acciaio inox lucidato a specchio con getto pioggia e cascata, doccetta in ABS a 4 funzioni con pulsante per il cambio dell'intensità, flessibile 150cm. Set da completare con un miscelatore a incasso a 3 vie (NON incluso).

Set for shower, including: wall water connection with hand shower holder, wall-mounted shower head in mirror-polished stainless steel with rain and waterfall jets, 4-function abs hand shower with button for jets mode switching, 150cm flexible hose. Set to be completed with a 3-way built-in mixer (not included).



SD615Z4314CA

Set per doccia, composto da: attacco presa acqua a muro con supporto per doccetta, soffione a parete ultra-sottile in acciaio inox lucidato a specchio con getto pioggia e cascata, doccetta in ABS a 1 funzione, flessibile 150cm. Set da completare con un miscelatore a incasso a 3 vie (NON incluso).

Set for shower, including: wall water connection with hand shower holder, ultra-flat wall-mounted shower head in mirror-polished stainless steel with rain and waterfall jets, 1-function abs hand shower, 150cm flexible hose. Set to be completed with a 3-way built-in mixer (not included).



SD615Z4913CAQ

Set per doccia, composto da: attacco presa acqua a muro con supporto per doccetta, soffione a parete ultra-sottile in acciaio inox lucidato a specchio con getto pioggia e cascata, doccetta quadrata in ABS a 1 funzione, flessibile 150cm. Set da completare con un miscelatore a incasso a 3 vie (NON incluso).

Set for shower, including: wall water connection with hand shower holder, ultra-flat wall-mounted shower head in mirror-polished stainless steel with rain and waterfall jets, 1-function squared abs hand shower, 150cm flexible hose. Set to be completed with a 3-way built-in mixer (not included).



BOX INCASSO
BUILT-IN BOX

WELLNESS
KIT

CROMOTERAPIA
COLOUR THERAPY

SOFFIONI & SOFFIONI A SOFFITTO
SHOWER HEADS & CEILING

BOCCHE
SPOUTS

PANNELLI
PANELS

COLONNE
COLUMN

SALISCENDI
SLIDING RAILS

DOCCETTE
HAND SHOWERS

OASIS
SHUT-OFF

OUTDOOR

KIT WELLNESS DESIGN SQUADRATO - SQUARED DESIGN SHOWER KIT

2 VIE CON DEVIATORE A PRESSIONE - 2-WAY WITH PRESSURE DIVERTER



Set doccia a incasso, composto da: miscelatore a incasso con deviatore SKYLINE, attacco presa acqua a muro con supporto per doccetta, braccio a muro squadrato in ottone 30cm, soffione 20x20cm in abs, doccetta quadrata in abs a 1 funzione, flessibile 150cm.
Built-in shower set, including: built-in mixer with diverter SKYLINE, wall water connection with hand shower holder, 30cm squared brass wall arm, 20x20cm abs shower head, 1-function abs squared hand shower, 150cm flexible hose.

SK615ZQ491SD20Q
Con soffione doccia 20x20cm
With shower head 20x20cm

CR

SK615ZQ491SD25Q
Con soffione doccia 25x25cm
With shower head 25x25cm

CR

SK615ZQ491SD30Q
Con soffione doccia 30x30cm
With shower head 30x30cm

CR



Set doccia a incasso, composto da: miscelatore a incasso con deviatore SKYLINE, asta saliscendi squadrata, attacco presa acqua a muro, braccio a muro squadrato in ottone 30cm, soffione 20x20cm in abs, doccetta quadrata in abs a 1 funzione, flessibile 150cm.
Built-in shower set, including: built-in mixer with diverter SKYLINE, squared sliding rail, wall water connection, 30cm squared brass wall arm, 20x20cm abs shower head, 1-function abs squared hand shower, 150cm flexible hose.

SK614ZQ491SD20
Con soffione doccia 20x20cm
With shower head 20x20cm

CR

SK614ZQ491SD25
Con soffione doccia 25x25cm
With shower head 25x25cm

CR

SK614ZQ491SD30
Con soffione doccia 30x30cm
With shower head 30x30cm

CR



Set doccia a incasso, composto da: miscelatore a incasso con deviatore SKYLINE, attacco presa acqua a muro con supporto per doccetta, braccio a muro squadrato in ottone 30cm, soffione ultra piatto 20x20cm in acciaio INOX lucidato a specchio, doccetta quadrata in abs a 1 funzione, flessibile 150cm.
Built-in shower set, including: built-in mixer with diverter SKYLINE, wall water connection with hand shower holder, 30cm squared brass wall arm, ultra-flat 20x20cm shower head in mirror-polished stainless steel, 1-function abs squared hand shower, 150cm flexible hose.

SK615ZQ4917920Q
Con soffione doccia 20x20cm
With shower head 20x20cm

CR 15

SK615ZQ4917925Q
Con soffione doccia 25x25cm
With shower head 25x25cm

CR 15

SK615ZQ4917930Q
Con soffione doccia 30x30cm
With shower head 30x30cm

CR 15



Set doccia a incasso, composto da: miscelatore a incasso con deviatore SKYLINE, asta saliscendi rettangolare in ottone, attacco presa acqua a muro, braccio a muro squadrato in ottone 30cm, soffione ultra piatto 20x20cm in acciaio INOX lucidato a specchio, doccetta quadrata in abs a 1 funzione, flessibile 150cm.
Built-in shower set, including: built-in mixer with diverter SKYLINE, rectangular brass sliding rail, wall water connection, 30cm squared brass wall arm, ultra-flat 20x20cm shower head in mirror-polished stainless steel, 1-function abs squared hand shower, 150cm flexible hose.

SK614ZQ4917920
Con soffione doccia 20x20cm
With shower head 20x20cm

CR 15

SK614ZQ4917925
Con soffione doccia 25x25cm
With shower head 25x25cm

CR 15

SK614ZQ4917930
Con soffione doccia 30x30cm
With shower head 30x30cm

CR 15

SK615Z491562Q

CR 15

Come SK615ZQ4917920Q con soffione doccia a parete in acciaio inox lucidato a specchio.
As SK615ZQ4917920Q with stainless steel mirror polished wall shower head.



SK614Z491562

CR 15

Come SK614ZQ4917920 con soffione doccia a parete in acciaio inox lucidato a specchio.
As SK614ZQ4917920 with stainless steel mirror polished wall shower head.





Set doccia a incasso, composto da: miscelatore a incasso con deviatore SKYLINE, attacco presa acqua a muro con supporto per doccetta, braccio a muro squadrato in ottone 30cm, soffione in ottone, doccetta quadrata in ottone a 1 funzione, flessibile 150cm.
Built-in shower set, including: built-in mixer with diverter SKYLINE, wall water connection with hand shower holder, 30cm squared brass wall arm, brass shower head, 1-function squared brass hand shower, 150cm flexible hose.

SK615ZQ590QCR
 Con soffione doccia 20x20cm
 With shower head 20x20cm

CR	FIN A	FIN B
----	-------	-------

SK615ZQ93BQCR
 Con soffione doccia 30x30cm
 With shower head 30x30cm

CR	FIN A	FIN B
----	-------	-------



Set doccia a incasso, composto da: miscelatore a incasso con deviatore SKYLINE, asta saliscendi squadrata, attacco presa acqua a muro, braccio a muro squadrato in ottone 30cm, soffione 20x20cm in ottone, doccetta quadrata in ottone a 1 funzione, flessibile 150cm.
Built-in shower set, including: built-in mixer with diverter SKYLINE, squared sliding rail, wall water connection, 30cm squared brass wall arm, 20x20cm brass shower head, 1-function squared brass hand shower, 150cm flexible hose.

SK614ZQ590CR
 Con soffione doccia 20x20cm
 With shower head 20x20cm

CR	FIN A	FIN B
----	-------	-------

SK614ZQ93BCR
 Con soffione doccia 30x30cm
 With shower head 30x30cm

CR	FIN A	FIN B
----	-------	-------

□ □ □ 2 VIE CON DEVIATORE MECCANICO - 2-WAY WITH MECHANICAL DIVERTER □ □ □



Set doccia a incasso, composto da: miscelatore a incasso con deviatore a 2 vie SKYLINE, attacco presa acqua a muro con supporto per doccetta, braccio a muro squadrato in ottone 30cm, soffione ultra piatto 20x20cm in acciaio INOX lucidato a specchio, doccetta quadrata in ottone a 1 funzione, flessibile 150cm.
Built-in shower set, including: built-in mixer with 2-way diverter SKYLINE, wall water connection with hand shower holder, 30cm squared brass wall arm, ultra-flat shower head in mirror-polished stainless steel, 1-function squared brass hand shower, 150cm flexible hose.

SK615ZD2Q7920Q
 Con soffione doccia 20x20cm
 With shower head 20x20cm

CR	15
----	----

SK615ZD2Q7925Q
 Con soffione doccia 25x25cm
 With shower head 25x25cm

CR	15
----	----

SK615ZD2Q7930Q
 Con soffione doccia 30x30cm
 With shower head 30x30cm

CR	15
----	----

SK615ZD2562Q

Come SK615ZD2Q7920Q con soffione doccia a parete in acciaio inox lucidato a specchio.
 As SK615ZD2Q7920Q with stainless steel mirror polished wall shower head.



Set doccia a incasso, composto da: miscelatore a incasso con deviatore a 2 vie SKYLINE, asta saliscendi rettangolare in ottone, attacco presa acqua a muro, braccio a muro squadrato in ottone 30cm, soffione ultra piatto in acciaio INOX lucidato a specchio, doccetta quadrata in ottone a 1 funzione, flessibile 150cm.
Built-in shower set, including: built-in mixer with 2-way diverter SKYLINE, rectangular brass sliding rail, wall water connection, 30cm squared brass wall arm, ultra-flat shower head in mirror-polished stainless steel, 1-function squared brass hand shower, 150cm flexible hose.

SK614ZD2Q7920
 Con soffione doccia 20x20cm
 With shower head 20x20cm

CR	15
----	----

SK614ZD2Q7925
 Con soffione doccia 25x25cm
 With shower head 25x25cm

CR	15
----	----

SK614ZD2Q7930
 Con soffione doccia 30x30cm
 With shower head 30x30cm

CR	15
----	----

SK614ZD2562

Come SK614ZQ4917920 con soffione doccia a parete in acciaio inox lucidato a specchio.
 As SK614ZQ4917920 with stainless steel mirror polished wall shower head.



BOX INCASSO
 BUILT-IN BOX
 WELLNESS
 WELLNESS KIT
 CROMOTERAPIA
 COLOUR THERAPY
 SOFFIONI & SOFFIONI A SOFFITO
 SHOWER HEADS & CEILING
 BOCHE
 SPOUTS
 PANNELLI
 PANELS
 COLONNE
 COLUMN
 SALISCENDI
 SLIDING RAILS
 DOCCETTE
 HAND SHOWERS
 OASIS
 SHUT-OFF
 OUTDOOR

□ □ □ 3 VIE - 3-WAY □ □ □



Set doccia a incasso, composto da: miscelatore a incasso con deviatore a 3 vie SKYLINE, attacco presa acqua a muro con supporto per doccetta, soffione a parete in acciaio inox lucidato a specchio con getto pioggia e cascata, doccetta quadrata in ottone a 1 funzione, flessibile 150cm.

Built-in shower set, including: built-in mixer with 3-way diverter SKYLINE, wall water connection with hand shower holder, wall-mounted shower head in mirror-polished stainless steel with rain and waterfall jets, 1-function squared brass hand shower, 150cm flexible hose.

SK615ZD32CAQ

CR 15



Set doccia a incasso, composto da: miscelatore a incasso con deviatore a 3 vie SKYLINE, attacco presa acqua a muro con supporto per doccetta, soffione a parete ultra-sottile in acciaio inox lucidato a specchio, doccetta quadrata in ottone a 1 funzione, 6 getti a incasso, flessibile 150cm.

Built-in shower set, including: built-in mixer with 3-way diverter SKYLINE, wall water connection with hand shower holder, ultra-flat wall-mounted shower head in mirror-polished stainless steel, 1-function squared brass hand shower, 6 built-in body-jets, 150cm flexible hose.

SK616ZD3562Q

CR 15

SK615ZD33CAQ

CR 15

Come SK615ZD32CAQ con soffione doccia a parete ultrapiatto in acciaio inox, 2 getti (pioggia e cascata).

As SK615ZD32CAQ with stainless steel wall ultra-flat shower head, 2 jets (rain and waterfall).



SK616ZD3563Q

CR 15

Come SK616ZD3562Q con soffione doccia a parete ultrapiatto in acciaio inox 1 getto a pioggia.

As SK616ZD3562Q with stainless steel wall ultra-flat shower head, 1 rain jet.



□ □ □ 4/5 VIE - 4/5-WAY □ □ □

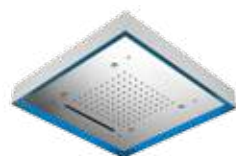

SK615ZD49AL57NCW

Set doccia a incasso, composto da: miscelatore a incasso con deviatore a 4 vie SKYLINE, attacco presa acqua a muro con supporto per doccetta, soffione retroilluminato a soffitto 57x57 cm con 3 funzioni: getto a pioggia, nebulizzazione (4 uscite) ed 1 getto a cascata, telecomando per luce LED, doccetta quadrata in ottone a 1 funzione, flessibile 150cm.

Built-in shower set, including: built-in mixer with 4-way diverter SKYLINE, wall water connection with hand shower holder, backlit ceiling 57x57 cm shower head with 3 functions: rain jet, nebulizer and 1 waterfall jet, remote control for LED light, 1-function squared brass hand shower, 150cm flexible hose.

CR

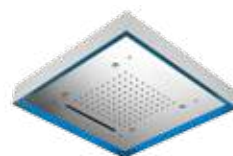

SK616ZD59AL57NCW

Set doccia a incasso, composto da: miscelatore a incasso con deviatore a 5 vie SKYLINE, attacco presa acqua a muro con supporto per doccetta, soffione retroilluminato a soffitto 57x57 cm con 3 funzioni: getto a pioggia, nebulizzazione (4 uscite) ed 1 getto a cascata, telecomando per luce LED, doccetta quadrata in ottone a 1 funzione, 6 getti a incasso, flessibile 150cm.

Built-in shower set, including: built-in mixer with 5-way diverter SKYLINE, wall water connection with hand shower holder, backlit ceiling 57x57 cm shower head with 3 functions: rain jet, nebulizer and 1 waterfall jet, remote control for LED light, 1-function squared brass hand shower, 6 built-in body-jets, 150cm flexible hose.

CR

— KIT WELLNESS DESIGN TONDO - ROUND DESIGN SHOWER KIT —

□ □ □ 2 VIE CON DEVIATORE A PRESSIONE - 2-WAY WITH PRESSURE DIVERTER □ □ □



Set doccia a incasso, composto da: miscelatore a incasso con deviatore SWING, attacco presa acqua a muro con supporto per doccetta, braccio a muro in ottone 30cm, soffione in abs, doccetta in abs a 1 funzione, flessibile 150cm.
Built-in shower set, including: built-in mixer with diverter SWING, wall water connection with hand shower holder, 30cm brass wall arm, abs shower head, 1-function abs hand shower, 150cm flexible hose.

SG615Z8420

Con soffione doccia Ø20cm
With shower head Ø20cm

— CR —

SG615Z8425

Con soffione doccia Ø25cm
With shower head Ø25cm

— CR —

SG615Z8430

Con soffione doccia Ø30cm
With shower head Ø30cm

— CR —



Set doccia a incasso, composto da: miscelatore a incasso con deviatore SWING, asta saliscendi, attacco presa acqua a muro, braccio a muro in ottone 30cm, soffione Ø 20cm in abs, doccetta in abs a 1 funzione, flessibile 150cm.
Built-in shower set, including: built-in mixer with diverter SWING, sliding rail, wall water connection, 30cm brass wall arm, abs shower head, 1-function abs hand shower, 150cm flexible hose.

SG614Z8420

Con soffione doccia Ø20cm
With shower head Ø20cm

— CR —

SG614Z8425

Con soffione doccia Ø25cm
With shower head Ø25cm

— CR —

SG614Z8430

Con soffione doccia Ø30cm
With shower head Ø30cm

— CR —



Set doccia a incasso, composto da: miscelatore a incasso con deviatore TOKYO, attacco presa acqua a muro con supporto per doccetta, braccio a muro in ottone 30cm, soffione ultra piatto in acciaio INOX lucidato a specchio, doccetta in abs a 1 funzione, flessibile 150cm.
Built-in shower set, including: built-in mixer with diverter TOKYO, wall water connection with hand shower holder, 30cm brass wall arm, ultra-flat Ø20cm shower head in mirror-polished stainless steel, 1-function abs hand shower, 150cm flexible hose.

TK615ZL4317820

Con soffione doccia Ø20cm
With shower head Ø20cm

— CR — 15 —

TK615ZL4317825

Con soffione doccia Ø25cm
With shower head Ø25cm

— CR — 15 —

TK615ZL4317830

Con soffione doccia Ø30cm
With shower head Ø30cm

— CR — 15 —

TK615Z431566

— CR — 15 —

Come TK615ZL4317820 con soffione doccia a parete in acciaio inox lucidato a specchio.
As TK615ZL4317820 with stainless steel mirror polished wall shower head.



Set doccia a incasso, composto da: miscelatore a incasso con deviatore TOKYO, asta saliscendi, attacco presa acqua a muro, braccio a muro in ottone 30cm, soffione ultra piatto in acciaio INOX lucidato a specchio, doccetta in abs a 1 funzione, flessibile 150cm.
Built-in shower set, including: built-in mixer with diverter TOKYO, sliding rail, wall water connection, 30cm brass wall arm, ultra-flat Ø20cm shower head in mirror-polished stainless steel, 1-function abs hand shower, 150cm flexible hose.

TK614ZL4317820

Con soffione doccia Ø20cm
With shower head Ø20cm

— CR —

TK614ZL4317825

Con soffione doccia Ø25cm
With shower head Ø25cm

— CR —

TK614ZL4317830

Con soffione doccia Ø30cm
With shower head Ø30cm

— CR —

TK614Z431566

— CR —

Come SK614ZQ4917920 con soffione doccia a parete in acciaio inox lucidato a specchio.
As SK614ZQ4917920 with stainless steel mirror polished wall shower head.



BOX INCASSO
BUILT-IN BOX

WELLNESS
KIT

CROMOTERAPIA
COLOUR THERAPY

SOFFIONI & SOFFIONI A SOFFITTO
SHOWER HEADS & CEILING

BOCCHE
SPOUTS

PANNELLI
PANELS

COLONNE
COLUMN

SALISCENDI
SLIDING RAILS

DOCCETTE
HAND SHOWERS

OASIS
SHUT-OFF

OUTDOOR

WELLNESS



Set doccia a incasso, composto da: miscelatore a incasso con deviatore TOKYO, attacco presa acqua a muro con supporto per doccetta, braccio a muro in ottone 30cm, soffione in ottone, doccetta in ottone a 1 funzione, flessibile 150cm.

Built-in shower set, including: built-in mixer with diverter TOKYO, wall water connection with hand shower holder, 30cm brass wall arm, brass shower head, 1-function brass hand shower, 150cm flexible hose.

TK615ZOLCR

Con soffione doccia Ø20cm
With shower head Ø20cm

CR FIN A FIN B



Set doccia a incasso, composto da: miscelatore a incasso con deviatore TOKYO, asta saliscendi in ottone, attacco presa acqua a muro, braccio a muro in ottone 30cm, soffione in ottone, doccetta in ottone a 1 funzione, flessibile 150cm.

Built-in shower set, including: built-in mixer with diverter TOKYO, brass sliding rail, wall water connection, 30cm brass wall arm, brass shower head, 1-function brass hand shower, 150cm flexible hose.

TK614ZOLCR

Con soffione doccia Ø20cm
With shower head Ø20cm

CR FIN A FIN B

TK615ZOL9430CR

Con soffione doccia Ø30cm
With shower head Ø30cm

CR FIN A FIN B

TK614ZOL9430CR

Con soffione doccia Ø30cm
With shower head Ø30cm

CR FIN A FIN B

□ □ □ 2 VIE CON DEVIATORE MECCANICO - 2-WAY WITH MECHANICAL DIVERTER □ □ □



Set doccia a incasso, composto da: miscelatore a incasso con deviatore a 2 vie TOKYO, attacco presa acqua a muro con supporto per doccetta, braccio a muro in ottone 30cm, soffione ultra piatto in acciaio INOX lucidato a specchio, doccetta in ottone a 1 funzione, flessibile 150cm.

Built-in shower set, including: built-in mixer with 2-way diverter TOKYO, wall water connection with hand shower holder, 30cm brass wall arm, ultra-flat shower head in mirror-polished stainless steel, 1-function brass hand shower, 150cm flexible hose.

TK615ZD2L7820

Con soffione doccia Ø20cm
With shower head Ø20cm

CR 15

TK615ZD2L7825

Con soffione doccia Ø25cm
With shower head Ø25cm

CR 15

TK615ZD2L7830

Con soffione doccia Ø30cm
With shower head Ø30cm

CR 15



Set doccia a incasso, composto da: miscelatore a incasso con deviatore a 2 vie TOKYO, asta saliscendi in ottone, attacco presa acqua a muro, braccio a muro in ottone 30cm, soffione ultra piatto Ø20cm in acciaio INOX lucidato a specchio, doccetta in ottone a 1 funzione, flessibile 150cm.

Built-in shower set, including: built-in mixer with 2-way diverter TOKYO, sliding rail, wall water connection, 30cm brass wall arm, ultra-flat shower head in mirror-polished stainless steel, 1-function brass hand shower, 150cm flexible hose.

TK614ZD2L7820

Con soffione doccia Ø20cm
With shower head Ø20cm

CR

TK614ZD2L7825

Con soffione doccia Ø25cm
With shower head Ø25cm

CR

TK614ZD2L7830

Con soffione doccia Ø30cm
With shower head Ø30cm

CR

TK615ZD2566

CR 15

Come TK615ZD2L7820 con soffione doccia a parete in acciaio inox lucidato a specchio.
As TK615ZD2L7820 with stainless steel mirror polished wall shower head.



TK614ZD2566

CR

Come TK614ZD2L7820 con soffione doccia a parete in acciaio inox lucidato a specchio.
As TK614ZD2L7820 with stainless steel mirror polished wall shower head.



□ □ □ 3 VIE - 3-WAY □ □ □



Set doccia a incasso, composto da: miscelatore a incasso con deviatore a 3 vie TOKYO, attacco presa acqua a muro con supporto per doccetta, soffione a parete in acciaio inox lucidato a specchio con getto pioggia e cascata, doccetta in ottone a 1 funzione, flessibile 150cm.
Built-in shower set, including: built-in mixer with 3-way diverter TOKYO, wall water connection with hand shower holder, wall-mounted shower head in mirror-polished stainless steel with rain and waterfall jets, 1-function brass hand shower, 150cm flexible hose.

TK615ZD36CA

CR 15



Set doccia a incasso, composto da: miscelatore a incasso con deviatore a 3 vie TOKYO, attacco presa acqua a muro con supporto per doccetta, braccio a muro in ottone 30cm, soffione a pioggia tondo, altezza 3cm, acciaio inox lucidato a specchio, doccetta in ottone a 1 funzione, flessibile 150cm.
Built-in shower set, including: built-in mixer with 3-way diverter TOKYO, wall water connection with hand shower holder, 30cm brass wall arm, round shower head, height 3cm, mirror polished stainless steel, 1-function brass hand shower, 150cm flexible hose.

TK615ZD3LXT8322

Con soffione doccia Ø22cm
With shower head Ø22cm

CR 15

TK615ZD3LXT8332

Con soffione doccia Ø32cm
With shower head Ø32cm

CR 15

TK615ZD34CA

CR 15

Come TK615ZD36CA con soffione doccia a parete ultrapiatto in acciaio inox, 2 getti (pioggia e cascata).
As TK615ZD36CA with stainless steel wall ultra-flat shower head, 2 jets (rain and waterfall).



TK615ZD3XT566

CR 15

Come TK614ZD2L7820 con soffione doccia a parete in acciaio inox lucidato a specchio.
As TK614ZD2L7820 with stainless steel mirror polished wall shower head.



□ □ □ 4/5 VIE - 4/5-WAY □ □ □



TK615ZD4XT8J55N

Set doccia a incasso, composto da: miscelatore a incasso con deviatore a 4 vie TOKYO, attacco presa acqua a muro con supporto per doccetta, soffione a soffitto con luce LED, 2 getti: pioggia e nebulizzazione, tastiera a parete per controllo led, doccetta in ottone a 1 funzione, flessibile 150cm.
Built-in shower set, including: built-in mixer with 4-way diverter TOKYO, wall water connection with hand shower holder, ceiling shower head with LED light, 2 functions: rain jet and nebulizer, wall panel for led control, 1-function brass hand shower, 150cm flexible hose.

CR



TK616ZD5XT8J55N

Set doccia a incasso, composto da: miscelatore a incasso con deviatore a 5 vie TOKYO, attacco presa acqua a muro con supporto per doccetta, soffione a soffitto Ø 55 cm con luce LED, 2 getti: pioggia e nebulizzazione, tastiera a parete per controllo led, doccetta in ottone a 1 funzione, 6 getti a incasso, flessibile 150cm.
Built-in shower set, including: built-in mixer with 5-way diverter TOKYO, wall water connection with hand shower holder, Ø 55 cm ceiling shower head with LED light, 2 functions: rain jet and nebulizer, wall panel for led control, 1-function brass hand shower, 6 built-in body-jets, 150cm flexible hose.

CR

BOX INCASSO
BUILT-IN BOX

WELLNESS
KIT

CROMOTERAPIA
COLOUR THERAPY

SOFFIONI & SOFFIONI A SOFFITTO
SHOWER HEADS & CEILING

BOCCHE
SPOUTS

PANNELLI
PANELS

COLONNE
COLUMN

SALISCENDI
SLIDING RAILS

DOCCETTE
HAND SHOWERS

OASIS
SHUT-OFF

OUTDOOR

CROMOTERAPIA COLOUR THERAPIE

Aggiungi all'interno della tua doccia il potere rilassante della cromoterapia: una morbida luce colorata esalta il fluire dell'acqua e crea un vero effetto spa nella tua casa.

Add the relaxing power of colour therapy to your shower interior: a soft coloured light enhances the flow of water and creates a real spa effect inside your home.

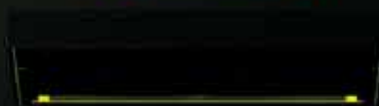
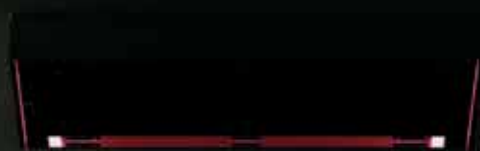

SOFFIONI QUADRATI A SOFFITTO CON CORNICE LED
SQUARE CEILING SHOWER HEAD WITH LED FRAME

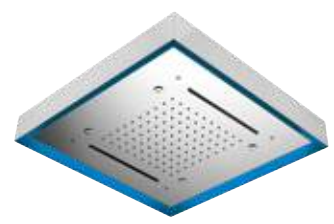
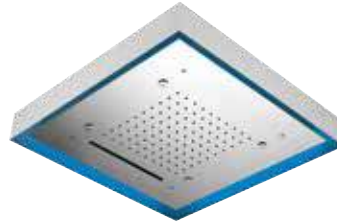
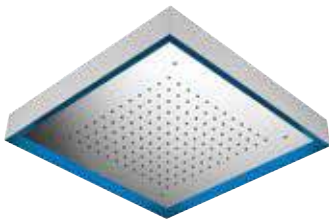

Soffione retroilluminato a soffitto in Acciaio INOX anti-calcare **57x57 cm**, con getto a pioggia. Luce LED a 7 colori con 40 sfumature, alimentazione dalla rete elettrica con trasformatore a basso voltaggio incluso (12V).
Ceiling stainless steel backlighted antilimestone shower head 57x57 cm, with 1 rain jet. 7 colors light led with 40 shades. Powered by electricity with low voltage transformer included (12V).

Soffione retroilluminato a soffitto in Acciaio INOX anti-calcare **57x57 cm**, con 3 funzioni: getto a pioggia, nebulizzazione (4 uscite) ed 1 getto a cascata. Luce LED a 7 colori con 40 sfumature, alimentazione dalla rete elettrica con trasformatore a basso voltaggio incluso (12V).
Ceiling stainless steel backlighted antilimestone shower head 57x57 cm, with 3 functions: 1 rain jet nebulization (4 outlets) and 1 waterfall jet. 7 colors light led with 40 shades. Powered by electricity with low voltage transformer included (12V).

Soffione retroilluminato a soffitto in Acciaio INOX anti-calcare **57x57 cm**, con 3 funzioni: getto a pioggia, nebulizzazione (4 uscite) e 2 getti a cascata. Luce LED a 7 colori con 40 sfumature, alimentazione dalla rete elettrica con trasformatore a basso voltaggio incluso (12V).
Ceiling stainless steel backlighted antilimestone shower head 57x57 cm, with 3 functions: 1 rain jet nebulization (4 outlets) and 2 waterfall jets. 7 colors light led with 40 shades. Powered by electricity with low voltage transformer included (12V).

A579ALCM57
Con pulsantiera a parete CR
With wall push-button

A579ALCM57NC
Con pulsantiera a parete CR
With wall push-button

A579ALCM57N2C
Con pulsantiera a parete CR
With wall push-button

A579ALCM57W
Con pulsantiera wireless CR
With wireless remote

A579ALCM57NCW
Con pulsantiera wireless CR
With wireless remote

A579ALCM57N2CW
Con pulsantiera wireless CR
With wireless remote

□ □ □ INCASSO A FILO SOFFITTO - RECESSED CEILING □ □ □

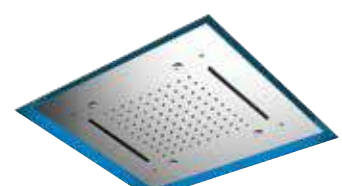
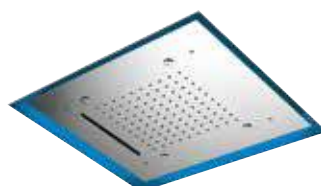
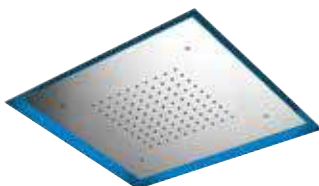

Soffione retroilluminato ad incasso in Acciaio INOX anti-calcare **57x57 cm**, con getto a pioggia. Luce LED a 7 colori con 40 sfumature, alimentazione dalla rete elettrica con trasformatore a basso voltaggio incluso (12V).
Built-in stainless steel backlighted antilimestone shower head 57x57 cm, with 1 rain jet. 7 colors light led with 40 shades. Powered by electricity with low voltage transformer included (12V).

Soffione retroilluminato ad incasso in Acciaio INOX anti-calcare **57x57 cm**, con 3 funzioni: getto a pioggia, nebulizzazione (4 uscite) ed 1 getto a cascata. Luce LED a 7 colori con 40 sfumature, alimentazione dalla rete elettrica con trasformatore a basso voltaggio incluso (12V).
Built-in stainless steel backlighted antilimestone shower head 57x57 cm, with 3 functions: 1 rain jet nebulization (4 outlets) and 1 waterfall jet. 7 colors light led with 40 shades. Powered by electricity with low voltage transformer included (12V).

Soffione retroilluminato ad incasso in Acciaio INOX anti-calcare **57x57 cm**, con 3 funzioni: getto a pioggia, nebulizzazione (4 uscite) e 2 getti a cascata. Luce LED a 7 colori con 40 sfumature, alimentazione dalla rete elettrica con trasformatore a basso voltaggio incluso (12V).
Built-in stainless steel backlighted antilimestone shower head 57x57 cm, with 3 functions: 1 rain jet nebulization (4 outlets) and 2 waterfall jets. 7 colors light led with 40 shades. Powered by electricity with low voltage transformer included (12V).

A579AICM57
Con pulsantiera a parete CR
With wall push-button

A579AICM57NC
Con pulsantiera a parete CR
With wall push-button

A579AICM57N2C
Con pulsantiera a parete CR
With wall push-button

A579AICM57W
Con pulsantiera wireless CR
With wireless remote

A579AICM57NCW
Con pulsantiera wireless CR
With wireless remote

A579AICM57N2CW
Con pulsantiera wireless CR
With wireless remote

SCEGLIERE IL MODELLO DI SOFFIONE CON L'OPZIONE DI CONTROLLO DESIDERATA:
 CHOOSE THE SHOWER HEAD MODEL WITH THE DESIRED CONTROL OPTION:

Pulsantiera con installazione a parete
 Wall mounting push-button

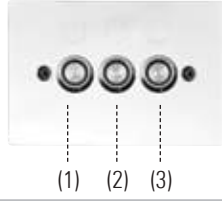

Telecomando wireless
 (lettera W alla fine del codice prodotto del soffione)
 Wireless remote control
 (W letter at the end of the shower head product code)

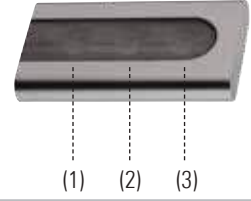

1) Accensione del led in luce bianca. 2) Selezione colori. 3) Rotazione automatica dei colori.
 1) White light LED light switching on 2) Color selection 3) Automatic color rotation.

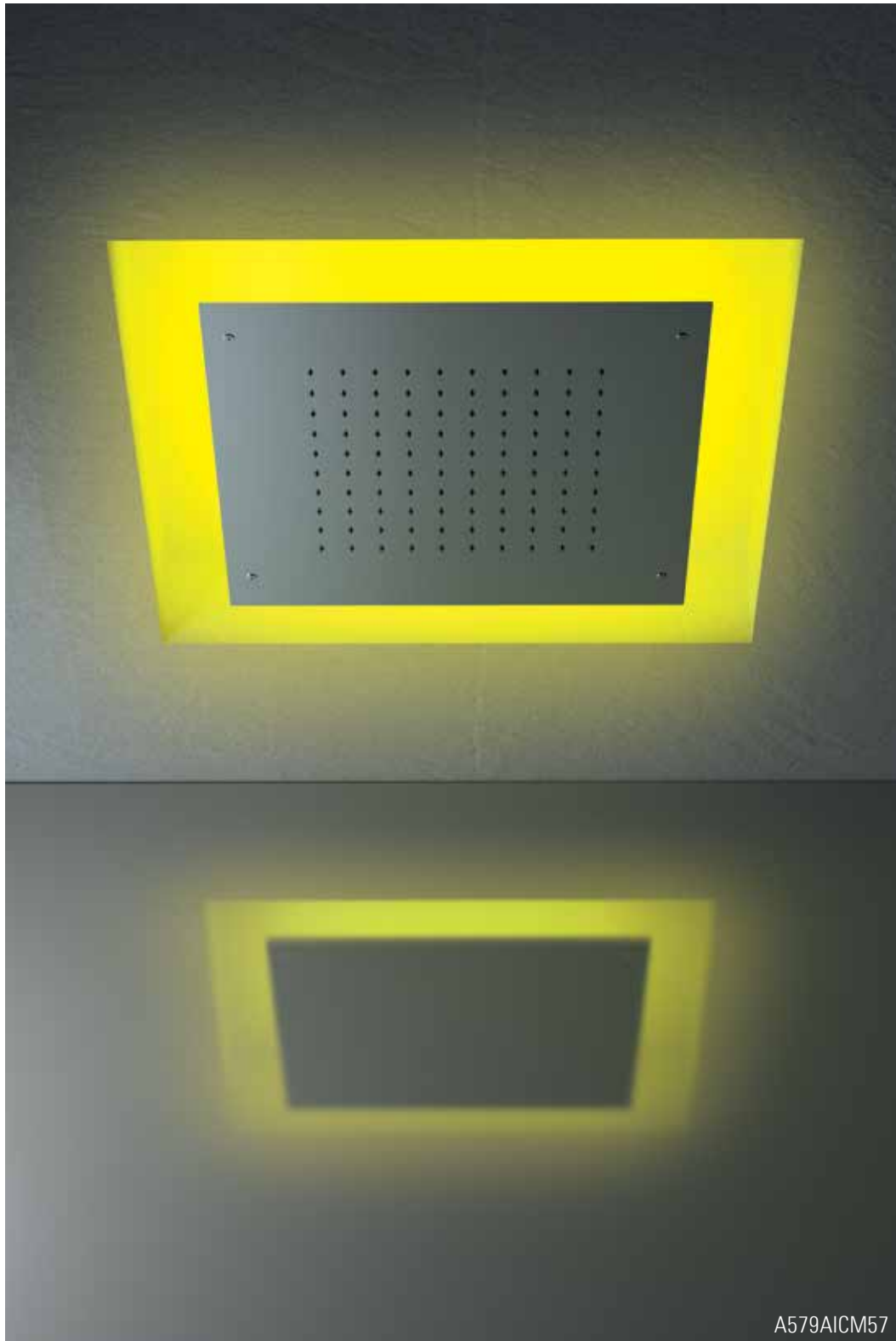

A579AICM57

BOX INCASSO
 BUILT-IN BOX

WELLNESS
 KIT

CROMOTERAPIA
COLOUR THERAPY

SOFFIONI & SOFFIONI A SOFFITTO
 SHOWER HEADS & CEILING

BOCCHE
 SPOUTS

PANNELLI
 PANELS

COLONNE
 COLUMN

SALISCENDI
 SLIDING RAILS

DOCCETTE
 HAND SHOWERS

OASIS
 SHUT-OFF

OUTDOOR

SOFFIONI RETTANGOLARI A SOFFITTO CON CORNICE LED
RECTANGULAR CEILING SHOWER HEAD WITH LED FRAME

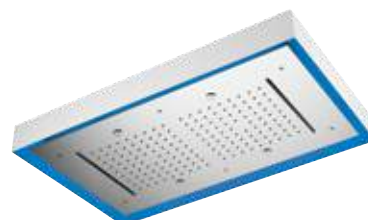

Soffione retroilluminato a soffitto in Acciaio INOX anti-calcare **77x47 cm**, con 2 postazioni pioggia. Luce LED a 7 colori con 40 sfumature, alimentazione dalla rete elettrica con trasformatore a basso voltaggio incluso (12V).

Ceiling stainless steel backlighted antilimestone shower head 77x47 cm, with 2 workstations rain jet. 7 colors light led with 40 shades. Powered by electricity with low voltage transformer included (12V).



A579RAL7747

Con pulsantiera a parete
With wall push-botton



A579RAL7747W

Con pulsantiera wireless
With wireless remote



Soffione a soffitto in Acciaio INOX **77x47 cm**, con 3 funzioni: 2 getti cascata, nebulizzazione (4 uscite) e 2 postazioni pioggia. Luce LED a 7 colori con 40 sfumature, alimentazione dalla rete elettrica con trasformatore a basso voltaggio incluso (12V).

Ceiling stainless steel backlighted antilimestone shower head 77x47 cm, with 3 functions: 2 workstations rain jet, nebulization (4 outlets) and 2 waterfall jets. 7 colors light led with 40 shades. Powered by electricity with low voltage transformer included (12V).



A579RAL7747N2C

Con pulsantiera a parete
With wall push-botton



A579RAL7747N2CW

Con pulsantiera wireless
With wireless remote



□ □ □ INCASSO A FILO SOFFITTO - RECESSED CEILING □ □ □

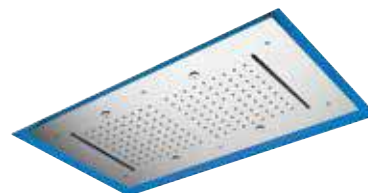
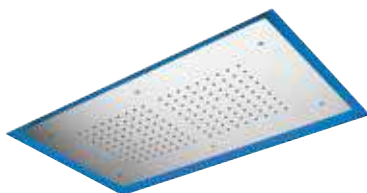

Soffione retroilluminato ad incasso in Acciaio INOX anti-calcare **77x47 cm**, con 2 postazioni pioggia. Luce LED a 7 colori con 40 sfumature, alimentazione dalla rete elettrica con trasformatore a basso voltaggio incluso (12V).

Built-in stainless steel backlighted antilimestone shower head 77x47 cm, with 2 workstations rain jet. 7 colors light led with 40 shades. Powered by electricity with low voltage transformer included (12V).



A579RAI7747

Con pulsantiera a parete
With wall push-botton



A579RAI7747W

Con pulsantiera wireless
With wireless remote



Soffione ad incasso in Acciaio INOX **77x47 cm**, con 3 funzioni: 2 getti cascata, nebulizzazione (4 uscite) e 2 postazioni pioggia. Luce LED a 7 colori con 40 sfumature, alimentazione dalla rete elettrica con trasformatore a basso voltaggio incluso (12V).

Built-in stainless steel backlighted antilimestone shower head 77x47 cm, with 3 functions: 2 workstations rain jet, nebulization (4 outlets) and 2 waterfall jets. 7 colors light led with 40 shades. Powered by electricity with low voltage transformer included (12V).



A579RAI7747N2C

Con pulsantiera a parete
With wall push-botton



A579RAI7747N2CW

Con pulsantiera wireless
With wireless remote



SOFFIONI TONDI A SOFFITTO CON CORNICE LED
ROUND CEILING SHOWER HEAD WITH LED FRAME

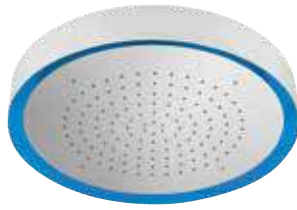

Soffione retroilluminato a soffitto in Acciaio INOX anti-calcare **Ø57 cm**, getto pioggia. Luce LED a 7 colori con 40 sfumature, alimentazione dalla rete elettrica con trasformatore a basso voltaggio incluso (12V).
Ceiling stainless steel backlighted antilimestone shower head Ø57 cm, with rain jet. 7 colors light led with 40 shades. Powered by electricity with low voltage transformer included (12V).

Soffione retroilluminato a soffitto in Acciaio INOX anti-calcare **Ø57 cm**, con 2 funzioni: getto pioggia e nebulizzazione (4 uscite). Luce LED a 7 colori con 40 sfumature, alimentazione dalla rete elettrica con trasformatore a basso voltaggio incluso (12V).
Ceiling stainless steel backlighted antilimestone shower head Ø57 cm, with 2 functions: rain jet and nebulization (4 outlets). 7 colors light led with 40 shades. Powered by electricity with low voltage transformer included (12V).

A578ALCM57
Con pulsantiera a parete
With wall push-botton

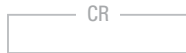

A578ALCM57N
Con pulsantiera a parete
With wall push-botton



A578ALCM57W
Con pulsantiera wireless
With wireless remote



A578ALCM57NW
Con pulsantiera wireless
With wireless remote

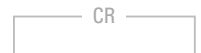

INCASSO A FILO SOFFITTO - RECESSED CEILING



Soffione retroilluminato ad incasso in Acciaio INOX anti-calcare **Ø57 cm**, getto pioggia. Luce LED a 7 colori con 40 sfumature, alimentazione dalla rete elettrica con trasformatore a basso voltaggio incluso (12V).
Built-in stainless steel backlighted antilimestone shower head Ø57 cm, with rain jet. 7 colors light led with 40 shades. Powered by electricity with low voltage transformer included (12V).

Soffione retroilluminato ad incasso in Acciaio INOX anti-calcare **Ø57 cm**, con 2 funzioni: getto pioggia e nebulizzazione (4 uscite). Luce LED a 7 colori con 40 sfumature, alimentazione dalla rete elettrica con trasformatore a basso voltaggio incluso (12V).
Built-in stainless steel backlighted antilimestone shower head Ø57 cm, with 2 functions: rain jet and nebulization (4 outlets). 7 colors light led with 40 shades. Powered by electricity with low voltage transformer included (12V).

A578AICM57
Con pulsantiera a parete
With wall push-botton

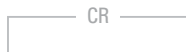

A578AICM57N
Con pulsantiera a parete
With wall push-botton

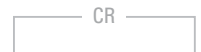

A578AICM57W
Con pulsantiera wireless
With wireless remote



A578AICM57NW
Con pulsantiera wireless
With wireless remote



BOX INCASSO
BUILT-IN BOX

WELLNESS
KIT

CROMOTERAPIA
COLOUR THERAPY

SOFFIONI & SOFFIONI A SOFFITTO
SHOWER HEADS & CEILING

BOCCHE
SPOUTS

PANNELLI
PANELS

COLONNE
COLUMN

SALISCENDI
SLIDING RAILS

DOCCETTE
HAND SHOWERS

OASIS
SHUT-OFF

OUTDOOR

SOFFIONI QUADRATI A SOFFITTO CON STRISCE LED
SQUARED CEILING SHOWER HEAD WITH LED STRIPES



Soffione a soffitto in Acciaio INOX lucidato a specchio **43x43 cm**, con getto a pioggia. Luce LED a 7 colori con 40 sfumature, alimentazione dalla rete elettrica con trasformatore a basso voltaggio incluso (12V).

*Ceiling stainless steel mirror polished shower head **43x43 cm**, rain jet. 7 colors light led with 40 shades. Powered by electricity with low voltage transformer included (12V).*

A579JCM43

Con pulsantiera a parete CR
With wall push-button

A579JCM43W

Con pulsantiera wireless CR
With wireless remote

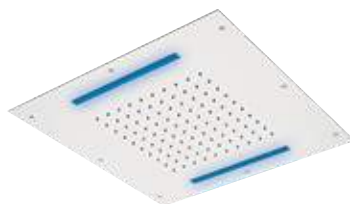

Soffione a soffitto in Acciaio INOX lucidato a specchio **50x50 cm**, con getto a pioggia. Luce LED a 7 colori con 40 sfumature, alimentazione dalla rete elettrica con trasformatore a basso voltaggio incluso (12V).

*Ceiling stainless steel mirror polished shower head **50x50 cm**, rain jet. 7 colors light led with 40 shades. Powered by electricity with low voltage transformer included (12V).*

A579JCM50

Con pulsantiera a parete CR
With wall push-button

A579JCM50W

Con pulsantiera wireless CR
With wireless remote



Soffione a incasso in Acciaio INOX lucidato a specchio **70x40 cm**, con 2 postazioni getto a pioggia. Luce LED a 7 colori con 40 sfumature, alimentazione dalla rete elettrica con trasformatore a basso voltaggio incluso (12V).

*Built-in stainless steel mirror polished shower head **70x40 cm**, 2 rain jet workstations. 7 colors light led with 40 shades. Powered by electricity with low voltage transformer included (12V).*

A579RJ7040

Con pulsantiera a parete CR
With wall push-button

A579RJ7040W

Con pulsantiera wireless CR
With wireless remote



Soffione a soffitto in Acciaio INOX lucidato a specchio **43x43 cm**, con 3 getti: 1 getto a pioggia, 1 getto a cascata e nebulizzazione (4 uscite). Luce LED a 7 colori con 40 sfumature, alimentazione dalla rete elettrica con trasformatore a basso voltaggio incluso (12V).

*Ceiling stainless steel mirror polished shower head **43x43 cm** 3 jets: 1 rain jet, 1 waterfall jet and nebulization (4 outlets). 7 colors light led with 40 shades. Powered by electricity with low voltage transformer included (12V).*

A579JCM43NC

Con pulsantiera a parete CR
With wall push-button

A579JCM43NCW

Con pulsantiera wireless CR
With wireless remote



Soffione a soffitto in Acciaio INOX lucidato a specchio **50x50 cm**, con 3 getti: 1 getto a pioggia, 1 getto a cascata e nebulizzazione (4 uscite). Luce LED a 7 colori con 40 sfumature, alimentazione dalla rete elettrica con trasformatore a basso voltaggio incluso (12V).

*Ceiling stainless steel mirror polished shower head **50x50 cm** 3 jets: 1 rain jet, 1 waterfall jet and nebulization (4 outlets). 7 colors light led with 40 shades. Powered by electricity with low voltage transformer included (12V).*

A579JCM50NC

Con pulsantiera a parete CR
With wall push-button

A579JCM50NCW

Con pulsantiera wireless CR
With wireless remote



Soffione a incasso in Acciaio INOX lucidato a specchio **70x40 cm**, con 3 funzioni: 2 postazioni getto a pioggia, nebulizzazione (4 uscite) ed 1 getto a cascata centrale. Luce LED a 7 colori con 40 sfumature, alimentazione dalla rete elettrica con trasformatore a basso voltaggio incluso (12V).

*Built-in stainless steel mirror polished shower head **70x40 cm**, with 3 functions: 2 rain jet workstations, nebulization (4 outlets) and 1 central waterfall jet. 7 colors light led with 40 shades. Powered by electricity with low voltage transformer included (12V).*

A579RJ7040NC

Con pulsantiera a parete CR
With wall push-button

A579RJ7040NCW

Con pulsantiera wireless CR
With wireless remote

SCEGLIERE IL MODELLO DI SOFFIONE CON L'OPZIONE DI CONTROLLO DESIDERATA:
 CHOOSE THE SHOWER HEAD MODEL WITH THE DESIRED CONTROL OPTION:

Pulsantiera con installazione a parete
 Wall mounting push-button

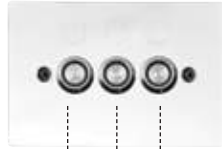

(1) (2) (3)

Telecomando wireless
 (lettera W alla fine del codice prodotto
 del soffione)
 Wireless remote control
 (W letter at the end of the shower
 head product code)



(1) (2) (3)

1) Accensione del led in luce bianca. 2) Selezione colori. 3) Rotazione automatica dei colori.
 1) White light LED light switching on 2) Color selection 3) Automatic color rotation.

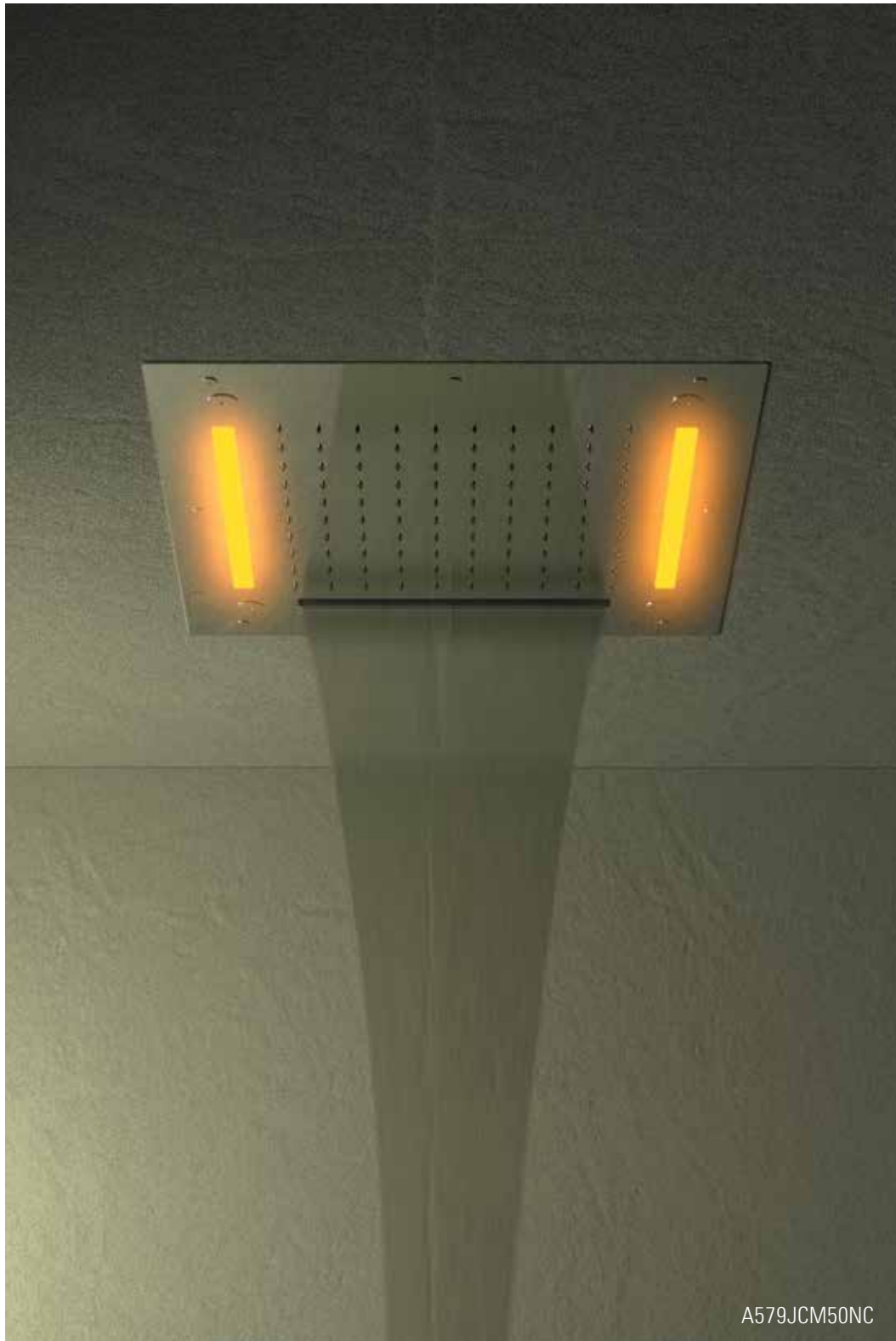

A579JCM50NC

BOX INCASSO
 BUILT-IN BOX

WELLNESS
 KIT

CROMOTERAPIA
COLOUR THERAPY

SOFFIONI & SOFFIONI A SOFFITTO
 SHOWER HEADS & CEILING

BOCCHIE
 SPOUTS

PANNELLI
 PANELS

COLONNE
 COLUMN

SALISCENDI
 SLIDING RAILS

DOCCETTE
 HAND SHOWERS

OASIS
 SHUT-OFF

OUTDOOR

SOFFIONI TONDI A SOFFITTO CON STRISCE LED
ROUND CEILING SHOWER HEAD WITH LED STRIPES



Soffione a soffitto in Acciaio INOX lucidato a specchio **Ø 42 cm**, con getto a pioggia. Luce LED a 7 colori con 40 sfumature, alimentazione dalla rete elettrica con trasformatore a basso voltaggio incluso (12V).

Ceiling stainless steel mirror polished shower head Ø 42 cm, rain jet. 7 colors light led with 40 shades. Powered by electricity with low voltage transformer included (12V).



A578JCM42

Con pulsantiera a parete
With wall push-button



A578JCM42W

Con pulsantiera wireless
With wireless remote

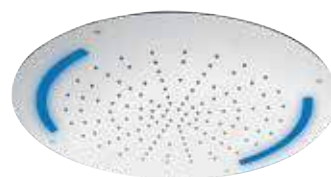

Soffione a soffitto in Acciaio INOX lucidato a specchio **Ø 55 cm**, con getto a pioggia. Luce LED a 7 colori con 40 sfumature, alimentazione dalla rete elettrica con trasformatore a basso voltaggio incluso (12V).

Ceiling stainless steel mirror polished shower head Ø 55 cm, rain jet. 7 colors light led with 40 shades. Powered by electricity with low voltage transformer included (12V).



A578JCM55

Con pulsantiera a parete
With wall push-button



A578JCM55W

Con pulsantiera wireless
With wireless remote



Soffione a soffitto in Acciaio INOX lucidato a specchio **Ø 42 cm**, con 2 getti: 1 getto a pioggia e nebulizzazione (4 uscite). Luce LED a 7 colori con 40 sfumature, alimentazione dalla rete elettrica con trasformatore a basso voltaggio incluso (12V).

Ceiling stainless steel mirror polished shower head Ø 42 cm 2 jets: 1, rain jet, nebulization (4 outlets). 7 colors light led with 40 shades. Powered by electricity with low voltage transformer included (12V).



A578JCM42N

Con pulsantiera a parete
With wall push-button



A578JCM42NW

Con pulsantiera wireless
With wireless remote

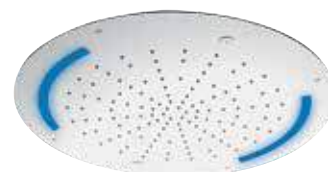

Soffione a soffitto in Acciaio INOX lucidato a specchio **Ø 55 cm**, con 2 getti: 1 getto a pioggia e nebulizzazione (4 uscite). Luce LED a 7 colori con 40 sfumature, alimentazione dalla rete elettrica con trasformatore a basso voltaggio incluso (12V).

Ceiling stainless steel mirror polished shower head Ø 55 cm 2 jets: 1, rain jet, nebulization (4 outlets). 7 colors light led with 40 shades. Powered by electricity with low voltage transformer included (12V).



A578JCM55N

Con pulsantiera a parete
With wall push-button



A578JCM55NW

Con pulsantiera wireless
With wireless remote



SCEGLIERE IL MODELLO DI SOFFIONE CON L'OPZIONE DI CONTROLLO DESIDERATA:
 CHOOSE THE SHOWER HEAD MODEL WITH THE DESIRED CONTROL OPTION:

Pulsantiera con installazione a parete
 Wall mounting push-button

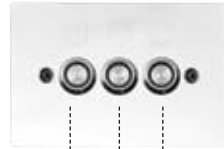

(1) (2) (3)

Telecomando wireless
 (lettera W alla fine del codice prodotto del soffione)
 Wireless remote control
 (W letter at the end of the shower head product code)



(1) (2) (3)

1) Accensione del led in luce bianca. 2) Selezione colori. 3) Rotazione automatica dei colori.
 1) White light LED light switching on 2) Color selection 3) Automatic color rotation.

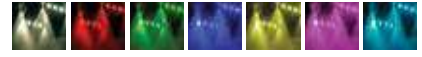

A578JCM55N

BOX INCASSO
 BUILT-IN BOX

WELLNESS
 KIT

CROMOTERAPIA
COLOUR THERAPY

SOFFIONI & SOFFIONI A SOFFITTO
 SHOWER HEADS & CEILING

BOCCHE
 SPOUTS

PANNELLI
 PANELS

COLONNE
 COLUMN

SALISCENDI
 SLIDING RAILS

DOCCETTE
 HAND SHOWERS

OASIS
 SHUT-OFF

OUTDOOR

SOFFIONI A SOFFITTO "EASY FIX" CON FARETTO LED
"EASY FIX" CEILING SHOWER HEAD WITH LED SPOTLIGHT



A579LEFCM34

Soffione quadrato a soffitto 34x34 cm con getto a pioggia e faretto per cromoterapia, ispezionabile, acciaio INOX lucidato a specchio. Sistema di montaggio "Easy Fix".
Square ceiling 34x34 cm shower head with rain jet and spotligh for colourtherapy, mirror polished stainless steel. "Easy Fix" mounting system.

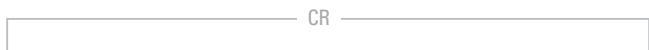

A579LEFCM44

Soffione quadrato a soffitto 44x44 cm con getto a pioggia e faretto per cromoterapia, ispezionabile, acciaio INOX lucidato a specchio. Sistema di montaggio "Easy Fix".
Square ceiling 44x44 cm shower head with rain jet and spotligh for colourtherapy, mirror polished stainless steel. "Easy Fix" mounting system.

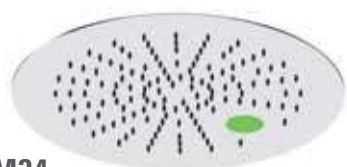

A578LEFCM34

Soffione tondo a soffitto Ø34 cm con getto a pioggia e faretto per cromoterapia, ispezionabile, acciaio INOX lucidato a specchio. Sistema di montaggio "Easy Fix".
Round ceiling Ø34 cm shower head with rain jet and spotligh for colourtherapy, mirror polished stainless steel. "Easy Fix" mounting system.

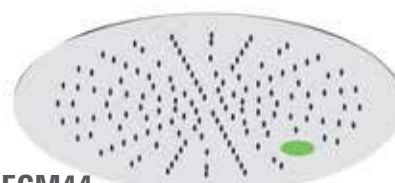

A578LEFCM44

Soffione tondo a soffitto Ø44 cm con getto a pioggia e faretto per cromoterapia, ispezionabile, acciaio INOX lucidato a specchio. Sistema di montaggio "Easy Fix".
Round ceiling Ø44 cm shower head with rain jet and spotligh for colourtherapy, mirror polished stainless steel. "Easy Fix" mounting system.



APPLICAZIONE A SOFFITTO "EASY FIX" - "EASY FIX" CEILING APPLICATION

Per questa tipologia di soffione e con questo specifico sistema di fissaggio sono previste quattro molle per ogni soffione.

For this specic shower-head with this specific mounting system, four springs are installed on each head.

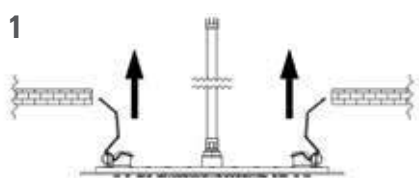

Nell'immagine 1 si evidenzia il primo movimento necessario: caricare due molle vicine tra loro mettendole quasi in posizione verticale rispetto al soffione ed inserirle all'interno del foro precedentemente preparato. Rilasciare le stesse delicatamente.

In picture 1, you shall see the first needed movement to activate them: Spring-load two springs next to each other placing them almost vertically and insert them in the hole in the ceiling; Release them gently;

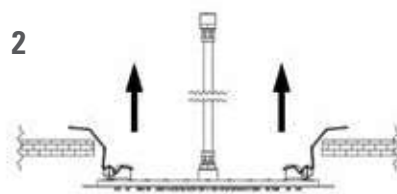

Mantenendo il soffione leggermente inclinato procedere caricando ed inserendo le rimanenti due molle come da immagine 2.

While keeping the showerhead slightly inclined, proceed by spring-loading and inserting the two other springs as shown in picture 2.

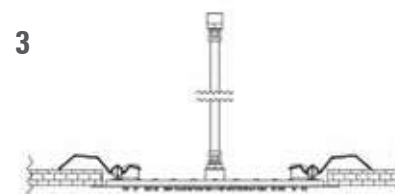

A questo punto rilasciare delicatamente le molle alla loro naturale tensione e, trattenendo esternamente il soffione, accompagnare lo stesso verso il totale appoggio al soffitto come da immagine 3.

Now release the springs back to their natural tension and, while holding the head from outside, guide it to its final position as shown in picture 3.



PULSANTIERA CON INSTALLAZIONE A PARETE IN DOTAZIONE AL PRODOTTO:
WALL MOUNTING PUSH-BUTTON PANEL SUPPLIED WITH THE PRODUCT:



Gestione delle funzioni di cromoterapia:

- Prima pressione: ACCESO
- Pressioni successive: scelta manuale del colore
- Pressione prolungata (2 secondi): rotazione automatica dei colori
- 2 pressioni consecutive: SPENTO

Sequenza colori LED RGB:

Bianco - Rosso - Verde - Blu - Giallo - Fucsia - Azzurro

Colour therapy functions control:

- First button press: POWER ON
- Subsequent button presses: manual colour selection
- Long press (2 seconds): automatic colour rotation
- 2 consecutive button presses: POWER OFF

RGB LED Colour sequence:

White - Red - Green - Blue - Yellow - Fuchsia - Bright Blue

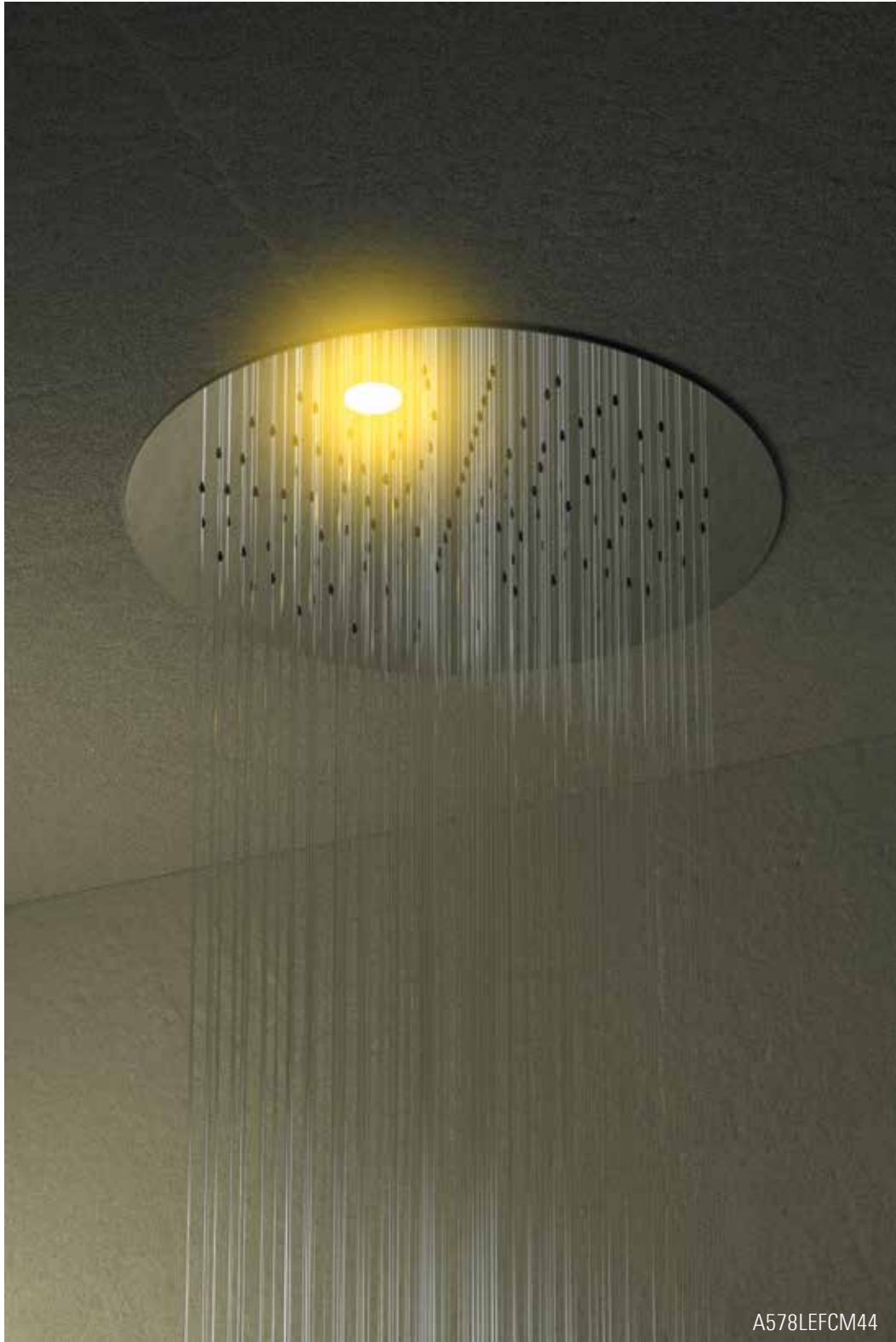

A578LEFCM44

BOX INCASSO
BUILT-IN BOX

WELLNESS
KIT

CROMOTERAPIA
COLOUR THERAPY

SOFFIONI & SOFFIONI A SOFFITTO
SHOWER HEADS & CEILING

BOCCHIE
SPOUTS

PANNELLI
PANELS

COLONNE
COLUMN



SALISCENDI
SLIDING RAILS

DOCCETTE
HAND SHOWERS

OASIS
SHUT-OFF

OUTDOOR

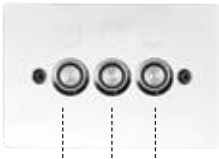
SCEGLIERE IL MODELLO DI SOFFIONE CON L'OPZIONE DI CONTROLLO DESIDERATA:
 CHOOSE THE SHOWER HEAD MODEL WITH THE DESIRED CONTROL OPTION:

<p>Pulsantiera con installazione a parete <i>Wall mounting push-button</i></p>  <p>(1) (2) (3)</p>	<p>Telecomando wireless (lettera W alla fine del codice prodotto del soffione) <i>Wireless remote control (W letter at the end of the shower head product code)</i></p>  <p>(1) (2) (3)</p>
<p>1) Accensione del led in luce bianca. 2) Selezione colori. 3) Rotazione automatica dei colori. 1) <i>White light LED light switching on</i> 2) <i>Color selection</i> 3) <i>Automatic color rotation.</i></p> 	

SOFFIONI RETTANGOLARI A SOFFITTO CON LUCI LED
 RECTANGULAR CEILING SHOWER HEAD WITH LED LIGHTS



Soffione a incasso in Acciaio INOX lucidato a specchio 50x50x1 cm, 1 postazione pioggia, 1 getto a cascata e nebulizzazione (4 uscite). Luce LED a 7 colori con 40 sfumature, alimentazione dalla rete elettrica con trasformatore a basso voltaggio incluso (12V).
Ceiling built-in stainless steel mirror polished shower head 50x50x5 cm, 1 rain jet workstation, 1 waterfall jet, nebulization (4 outlets). 7 colors light led with 40 shades. Powered by electricity with low voltage transformer included (12V).

A579LE1CM50NC
 Con pulsantiera a parete
With wall push-button



A579LE1CM50NCW
 Con pulsantiera wireless
With wireless remote



Soffione a soffitto in Acciaio INOX lucidato a specchio 50x50x5 cm, 1 postazione pioggia, 1 getto a cascata, 4 getti nebulizzati. Luce LED a 7 colori con 40 sfumature, alimentazione dalla rete elettrica con trasformatore a basso voltaggio incluso (12V).
Ceiling stainless steel mirror polished shower head 50x50x5 cm, 1 rain jet workstation, 1 waterfall jet, nebulization (4 outlets). 7 colors light led with 40 shades. Powered by electricity with low voltage transformer included (12V).

A579LE5CM50NC
 Con pulsantiera a parete
With wall push-button



A579LE5CM50NCW
 Con pulsantiera wireless
With wireless remote



Soffione a incasso in Acciaio INOX lucidato a specchio 70x40x1 cm, 2 postazioni pioggia, 1 getto a cascata centrale e nebulizzazione (4 uscite). Luce LED a 7 colori con 40 sfumature, alimentazione dalla rete elettrica con trasformatore a basso voltaggio incluso (12V).
Ceiling built-in stainless steel mirror polished shower head 70x40x5 cm, 2 rain jet workstations, 1 central waterfall jet, nebulization (4 outlets). 7 colors light led with 40 shades. Powered by electricity with low voltage transformer included (12V).

A579RLE17040NC
 Con pulsantiera a parete
With wall push-button

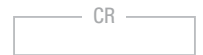

A579LE1CM50NCW
 Con pulsantiera wireless
With wireless remote



Soffione a soffitto in Acciaio INOX lucidato a specchio 70x40x5 cm, 2 postazioni pioggia, 1 getto a cascata centrale, 4 getti nebulizzati. Luce LED a 7 colori con 40 sfumature, alimentazione dalla rete elettrica con trasformatore a basso voltaggio incluso (12V).
Ceiling stainless steel mirror polished shower head 70x40x5 cm, 2 rain jet workstations, 1 central waterfall jet, nebulization (4 outlets). 7 colors light led with 40 shades. Powered by electricity with low voltage transformer included (12V).

A579RLE57040NC
 Con pulsantiera a parete
With wall push-button

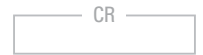

A579RLE57040NCW
 Con pulsantiera wireless
With wireless remote



SOFFIONI A PARETE CON LUCI LED WALL SHOWER HEAD WITH LED LIGHTS



Soffione a parete in Acciaio INOX lucidato a specchio 50x26x6,4 cm, con 1 postazione pioggia. Luce LED a 7 colori con 40 sfumature, alimentazione dalla rete elettrica con trasformatore a basso voltaggio incluso (12V).
Wall stainless steel mirror polished shower head 50x26x6,4 cm, 1 rain jet workstation. 7 colors light led with 40 shades. Powered by electricity with low voltage transformer included (12V).

Soffione a parete in Acciaio INOX lucidato a specchio 50x26x6,4 cm, con 1 postazione pioggia ed 1 getto a cascata. Luce LED a 7 colori con 40 sfumature, alimentazione dalla rete elettrica con trasformatore a basso voltaggio incluso (12V).
Wall stainless steel mirror polished shower head 50x26x6,4 cm, 1 rain jet workstation and waterfall jet. 7 colors light led with 40 shades. Powered by electricity with low voltage transformer included (12V).

●●●●●●●●
A562L

Con pulsantiera a parete
With wall push-button



●●●●●●●●
A562LCA

Con pulsantiera a parete
With wall push-button



●●●●●●●●
A562LW

Con pulsantiera wireless
With wireless remote



●●●●●●●●
A562LCAW

Con pulsantiera wireless
With wireless remote



A562L

BOX INCASSO
BUILT-IN BOX

WELLNESS
KIT

CROMOTERAPIA
COLOUR THERAPY

SOFFIONI & SOFFIONI A SOFFITTO
SHOWER HEADS & CEILING

BOCCHE
SPOUTS

PANNELLI
PANELS

COLONNE
COLUMN

SALISCENDI
SLIDING RAILS

DOCCETTE
HAND SHOWERS

OASIS
SHUT-OFF

OUTDOOR

SOFFIONI A SOFFITTO CEILING SHOWER HEADS

Eleganti, multi-funzionali ed estremamente moderni, i soffioni per doccia con montaggio a soffitto si confermano essere la scelta ideale per un ambiente doccia di alto design.

Elegant, multi-functional and distinctly modern, the ceiling mounted shower heads are confirmed as the ideal choice for a high design shower interior.



SOFFIONI & SOFFIONI A SOFFITTO
SHOWER HEADS & CEILING

A578PECM10/15/20



A578PECM10

Soffione doccia a soffitto, Ø 5 cm x 10 cm, areatore con getto a pioggia, acciaio INOX lucidato a specchio.

Ceiling shower head, Ø 5 cm x 10 cm, with rain jet aerator, mirror polished stainless steel.

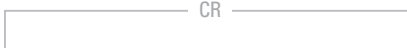

A578PECM15

Soffione doccia a soffitto, Ø 5 cm x 15 cm, areatore con getto a pioggia, acciaio INOX lucidato a specchio.

Ceiling shower head, Ø 5 cm x 15 cm, with rain jet aerator, mirror polished stainless steel.



A578PECM20

Soffione doccia a soffitto, Ø 5 cm x 20 cm, areatore con getto a pioggia, acciaio INOX lucidato a specchio.

Ceiling shower head, Ø 5 cm x 20 cm, with rain jet aerator, mirror polished stainless steel.



A578PECM10/15/20



A578PELCM10

Soffione doccia, Ø 5 cm x 10 cm, braccio a soffitto 10 cm con rosone, areatore con getto a pioggia, acciaio INOX lucidato a specchio.

Shower head, Ø 5 cm x 10 cm, 10cm ceiling arm with plate, rain jet aerator, mirror polished stainless steel.

CR



A578PELCM15

Soffione doccia, Ø 5 cm x 15 cm, braccio a soffitto 10 cm con rosone, areatore con getto a pioggia, acciaio INOX lucidato a specchio.

Shower head, Ø 5 cm x 15 cm, 10cm ceiling arm with plate, rain jet aerator, mirror polished stainless steel.

CR



A578PELCM20

Soffione doccia, Ø 5 cm x 20 cm, braccio a soffitto 10 cm con rosone, areatore con getto a pioggia, acciaio INOX lucidato a specchio.

Shower head, Ø 5 cm x 20 cm, 10cm ceiling arm with plate, rain jet aerator, mirror polished stainless steel.

CR



A578PELCM10/15/20

BOX INCASSO
BUILT-IN BOX

WELLNESS
KIT

CROMOTERAPIA
COLOUR THERAPY

SOFFIONI & SOFFIONI A SOFFITTO
SHOWER HEADS & CEILING

BOCCHIE
SPOUTS

PANNELLI
PANELS

COLONNE
COLUMN

SALISCENDI
SLIDING RAILS

DOCCETTE
HAND SHOWERS

OASIS
SHUT-OFF

OUTDOOR



Soffione tondo a soffitto con getto a pioggia, altezza 5cm, acciaio INOX lucidato a specchio.

Round ceiling shower head with rain jet, 5cm height, mirror polished stainless steel.

A578SFE5CM20

Ø 20 cm	CR
---------	----

A578SFE5CM37

Ø 37 cm	CR
---------	----



Soffione tondo a soffitto con getti a cascata, Ø20cm, altezza 5cm, acciaio INOX lucidato a specchio.

Round ceiling shower head with waterfall jets, Ø20cm, 5cm height, mirror polished stainless steel.

A578SFE5CM20CA

Ø 20 cm	CR
---------	----



A578SFE5CM20 - A578SFE5CM20CA



Soffione tondo a soffitto con cascata multigetto, Ø20cm, altezza 5cm, acciaio INOX lucidato a specchio.
Round ceiling shower head with multijet waterfall, Ø20cm, 5cm height, mirror polished stainless steel.

A578SFE5CM20CT

Ø 20 cm

CR



Soffione tondo a soffitto con 4 getti nebulizzati, Ø20cm, altezza 5cm, acciaio INOX lucidato a specchio.
Round ceiling shower head with 4 nebulized jets, Ø20cm, 5cm height, mirror polished stainless steel.

A578SFE5CM20N

Ø 20 cm

CR



A578SFE5CM20CT - A578SFE5CM20N

BOX INCASSO
BUILT-IN BOX

WELLNESS
KIT

CROMOTERAPIA
COLOUR THERAPY

SOFFIONI & SOFFIONI A SOFFITTO
SHOWER HEADS & CEILING

BOCCHE
SPOUTS

PANNELLI
PANELS

COLONNE
COLUMN

SALISCENDI
SLIDING RAILS

DOCCETTE
HAND SHOWERS

OASIS
SHUT-OFF

OUTDOOR

WELLNESS



Soffione quadrato a soffitto con getto a pioggia, altezza 5cm, acciaio INOX lucidato a specchio.

Squared ceiling shower head with rain jet, 5cm height, mirror polished stainless steel.



Soffione quadrato a soffitto con getti a cascata, 20x20cm, altezza 5cm, acciaio INOX lucidato a specchio.

Squared ceiling shower head with waterfall jets, 20x20cm, 5cm height, mirror polished stainless steel.

A579SFE5CM20

20x20 cm

CR

A579SFE5CM37

37x37 cm

CR

A579SFE5CM20CA

20x20 cm

CR



A579SFE5CM20 - A579SFE5CM20CA



Soffione quadrato a soffitto con cascata multigetto, 20x20cm, altezza 5cm, acciaio INOX lucidato a specchio.
Squared ceiling shower head with multijet waterfall, 20x20cm, 5cm height, mirror polished stainless steel.

A579SFE5CM20CT

20x20 cm

CR



Soffione quadrato a soffitto con 4 getti nebulizzati, 20x20cm, altezza 5cm, acciaio INOX lucidato a specchio.
Squared ceiling shower head with 4 nebulized jets, 20x20cm, 5cm height, mirror polished stainless steel.

A579SFE5CM20N

20x20 cm

CR

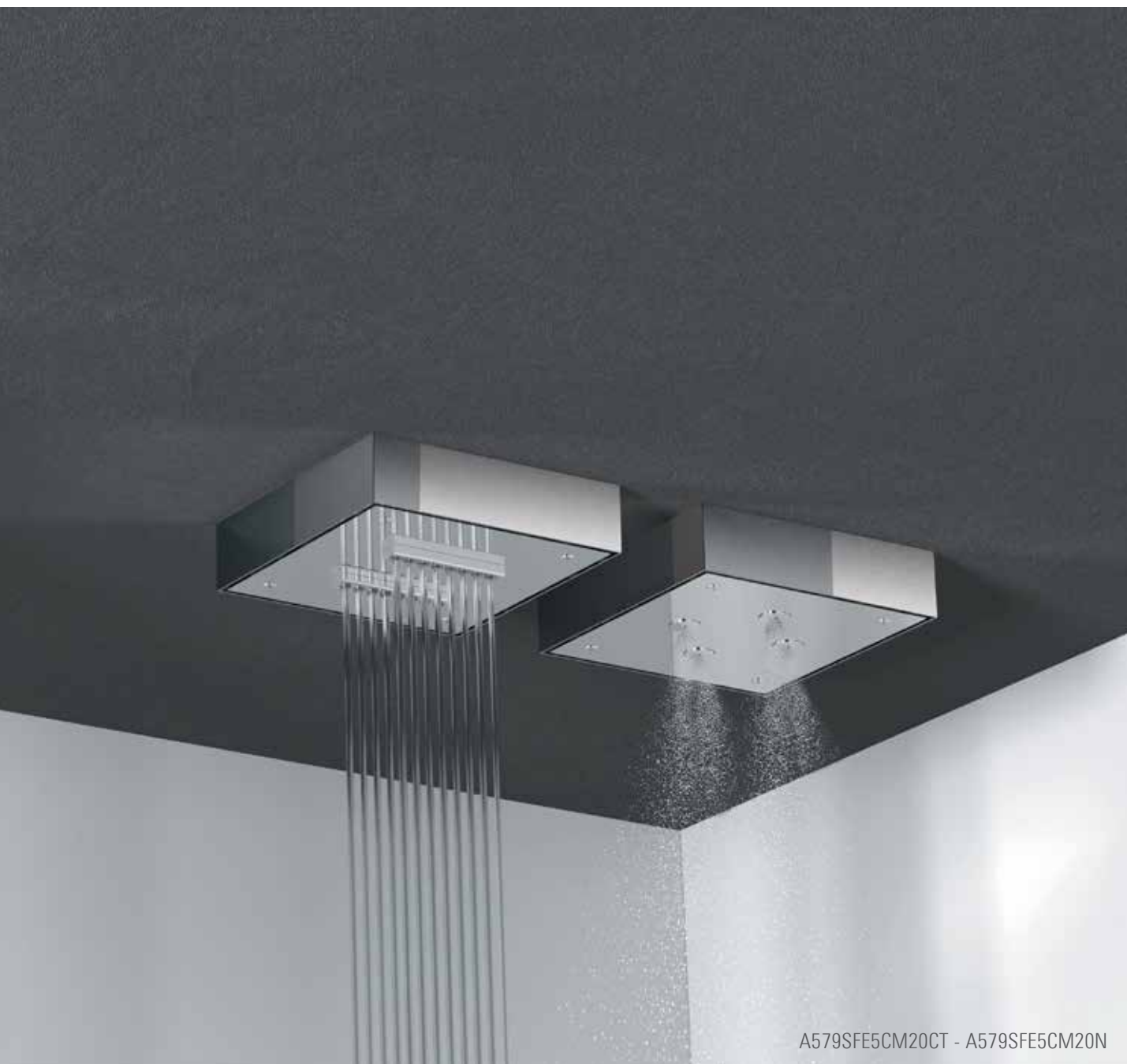

A579SFE5CM20CT - A579SFE5CM20N

BOX INCASSO
BUILT-IN BOX

WELLNESS
KIT

CROMOTERAPIA
COLOUR THERAPY

SOFFIONI & SOFFIONI A SOFFITTO
SHOWER HEADS & CEILING

BOCCHIE
SPOUTS

PANNELLI
PANELS

COLONNE
COLUMN

SALISCENDI
SLIDING RAILS

DOCCETTE
HAND SHOWERS

OASIS
SHUT-OFF

OUTDOOR

SOFFIONI A SOFFITTO CON TELAIO - CEILING SHOWER HEAD WITH FIXING SET



Soffione a soffitto in Acciaio INOX lucidato a specchio con sistema anticalcare, con getto a pioggia.

Ceiling stainless steel mirror polished shower head with antilimestone system, with rain jet.

A579SFCM30

30x30 cm

CR

A579SFCM43

43x43 cm

CR

A579SFCM50

50x50 cm

CR



Soffione a soffitto in Acciaio INOX lucidato a specchio con sistema anticalcare, a 2 funzioni: getto a pioggia e cascata.

Ceiling stainless steel mirror polished shower head with antilimestone system, 2 functions: rain and waterfall jets.

A579SFCM43C

43x43 cm

CR

A579SFCM50C

50x50 cm

CR



Soffione a soffitto in Acciaio INOX lucidato a specchio con sistema anticalcare, a 3 funzioni: getto a pioggia, nebulizzazione (4 uscite) ed 1 getto a cascata.

Ceiling stainless steel mirror polished shower head with antilimestone system, 3 functions: rain jet, nebulization (4 outlet) and waterfall jet.

A579SFCM43NC

43x43 cm

CR

A579SFCM50NC

50x50 cm

CR



A579SFCM43C



Soffione a soffitto in Acciaio INOX con sistema anti-calcare, 70x40 cm, 2 postazioni pioggia.
Ceiling stainless steel mirror polished shower head with antilimestone system 70x40 cm, with 2 rain jet workstations.

A579RSF7040



Soffione a soffitto in Acciaio INOX con sistema anti-calcare, 70x40 cm, a 2 funzioni: 2 postazioni pioggia, ed un getto a cascata centrale.
Ceiling stainless steel shower head with antilimestone system 70x40 cm, with 2 functions: 2 rain jet workstations and a central waterfall jet.

A579RSF7040C



Soffione a soffitto in Acciaio INOX lucidato a specchio con sistema anti-calcare, 70x40 cm, a 3 funzioni: 2 postazioni pioggia, nebulizzazione (4 uscite), ed un getto a cascata centrale.
Ceiling stainless steel shower head with antilimestone system 70x40 cm, with 3 functions: 2 rain jet workstation, nebulization (4 outlets) and a central waterfall jet.

A579RSF7040NC

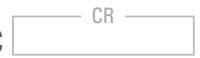

A579RSF7040C

BOX INCASSO
BUILT-IN BOX

WELLNESS
KIT

CROMOTERAPIA
COLOUR THERAPY

SOFFIONI & SOFFIONI A SOFFITTO
SHOWER HEADS & CEILING

BOCCHE
SPOUTS

PANNELLI
PANELS

COLONNE
COLUMN

SALISCENDI
SLIDING RAILS

DOCCETTE
HAND SHOWERS

OASIS
SHUT-OFF

OUTDOOR



Soffione a soffitto in Acciaio INOX lucidato a specchio con sistema anti-calcare, con getto a pioggia.
Ceiling stainless steel mirror polished shower head with antilimestone system, with rain jet.

A578SFCM30

Ø30 cm CR



Soffione a soffitto in Acciaio INOX lucidato a specchio con sistema anti-calcare Ø42 cm, a 2 funzioni: pioggia e nebulizzazione (4 uscite).
Ceiling stainless steel mirror polished shower head with antilimestone system Ø42 cm, with 2 functions: rain jet and nebulization (4 outlets).

A578SFCM42N

CR



Soffione a soffitto in Acciaio INOX lucidato a specchio con sistema anti-calcare Ø55 cm, a 2 funzioni: pioggia e nebulizzazione (6 uscite).
Ceiling stainless steel mirror polished shower head with antilimestone system Ø55 cm, with 2 functions: rain jet and nebulization (6 outlets).

A578SFCM55N

CR

A578SFCM40

Ø40 cm CR

A578SFCM55

Ø55 cm CR

SOFFIONI CUBO A SOFFITTO IN ACCIAIO INOX
 STAINLESS STEEL CEILING CUBE SHOWER HEAD

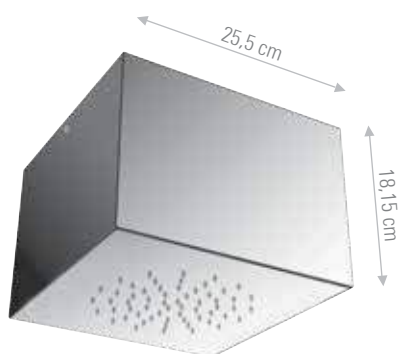

A579BX25

Soffione doccia 25,5x25,5 cm, Altezza 18,15 cm, a soffitto in acciaio INOX lucidato a specchio.
 1 getto pioggia.
Stainless steel mirror polished ceiling shower head 25,5x25,5 cm, height 18,15 cm. 1 rain jet.

CR

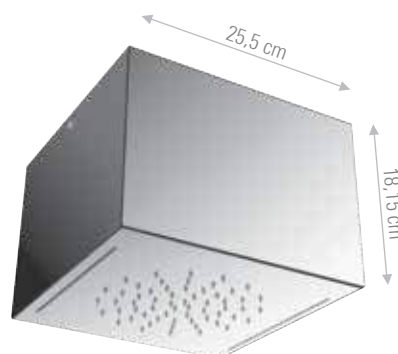

A579BX252C

Soffione doccia 25,5x25,5 cm, Altezza 18,15 cm, a soffitto in acciaio INOX lucidato a specchio.
 2 getti: getto pioggia e 2 postazioni cascata.
Stainless steel mirror polished ceiling shower head 25,5x25,5 cm, height 18,15 cm. 2 jets: rain jet and 2 waterfall jets.

CR

SOFFIONI A SOFFITTO "EASY FIX" - CEILING SHOWER HEAD "EASY FIX"



Soffione doccia EASY FIX in acciaio INOX lucidato a specchio.
EASY FIX stainless steel mirror polished shower head.

A578EFCM34

Ø 34 cm

CR



Soffione doccia EASY FIX in acciaio INOX lucidato a specchio.
EASY FIX stainless steel mirror polished shower head.

A579EFCM34

34x34 cm

CR

A578EFCM44

Ø 44 cm

CR

A579EFCM44

44x44 cm

CR

APPLICAZIONE A SOFFITTO "EASY FIX" - "EASY FIX" CEILING APPLICATION

Per questa tipologia di soffione e con questo specifico sistema di fissaggio sono previste quattro molle per ogni soffione.

For this specific shower-head with this specific mounting system, four springs are installed on each head.

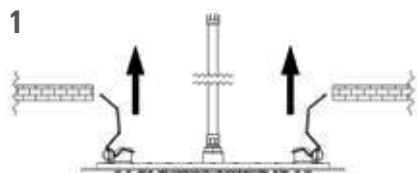

Nell'immagine 1 si evidenzia il primo movimento necessario: caricare due molle vicine tra loro mettendole quasi in posizione verticale rispetto al soffione ed inserirle all'interno del foro precedentemente preparato. Rilasciare le stesse delicatamente.

In picture 1, you shall see the first needed movement to activate them: Spring-load two springs next to each other placing them almost vertically and insert them in the hole in the ceiling; Release them gently;

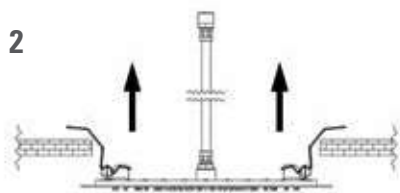

Mantenendo il soffione leggermente inclinato procedere caricando ed inserendo le rimanenti due molle come da immagine 2.

While keeping the showerhead slightly inclined, proceed by spring-loading and inserting the two other springs as shown in picture 2.

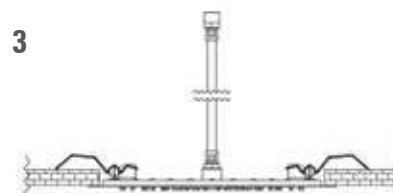

A questo punto rilasciare delicatamente le molle alla loro naturale tensione e, trattenendo esternamente il soffione, accompagnare lo stesso verso il totale appoggio al soffitto come da immagine 3.

Now release the springs back to their natural tension and, while holding the head from outside, guide it to its final position as shown in picture 3.

SOFFIONI SHOWER HEADS

Getti a pioggia e vere cascate per personalizzare l'ambiente doccia scegliendo tra stili, modelli e materiali differenti. Le diverse soluzioni permettono di installare i soffioni direttamente a parete o tramite braccio, lasciando la massima libertà progettuale in ogni contesto.

Rain jets and real waterfalls to design your shower interior by choosing from different styles, models and materials. The different shower head solutions can be installed directly on the wall or with arm mounting, for the maximum design freedom in any context.



SOFFIONI & SOFFIONI A SOFFITTO
SHOWER HEADS & CEILING

A559XN - A559XP

SOFFIONI CON INSTALLAZIONE A PARETE
WALL MOUNTING SHOWER HEAD

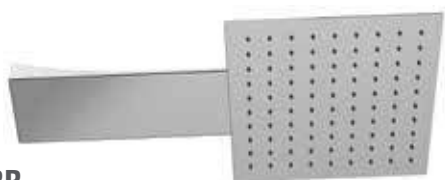

A563XRR

Soffione doccia ultrapiatto, 25x35 cm, con braccio design a parete 40 cm, in acciaio INOX lucidato a specchio.
Ultra slim wall showerhead, 25x35 cm, with 40 cm design shower arm, mirror polished stainless steel.

CR

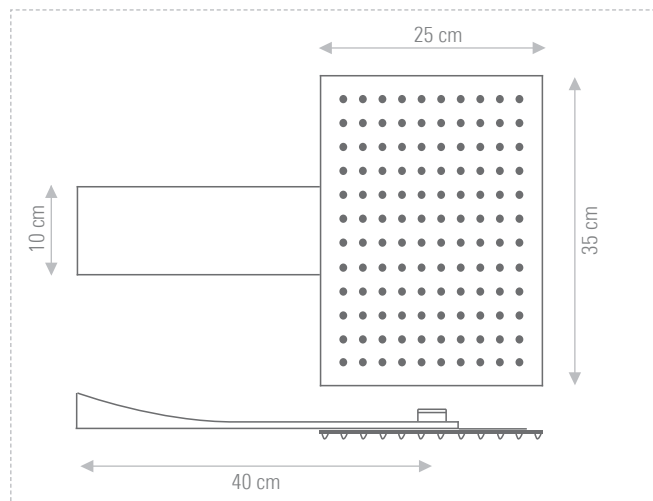

A562

Soffione doccia a parete 50x20 cm, in acciaio INOX lucidato a specchio.
Stainless steel mirror polished wall shower head 50x20 cm.

CR 15



A562CA

Soffione doccia a parete 50x20cm, in acciaio INOX lucidato a specchio, 2 getti, normale o cascata.
Stainless steel mirror polished wall shower head, 2 jets, normal and waterfall 50x20 cm.

CR 15

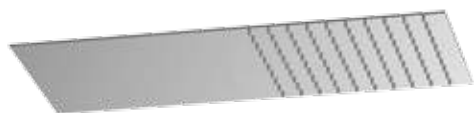

A563

Soffione doccia ultrapiatto 5mm, 50x25 cm, a parete in acciaio INOX lucidato a specchio.
Ultra slim stainless steel mirror polished wall shower head 50x25 cm.

CR 15



A563CA

Soffione doccia ultrapiatto 5mm, 50x25 cm, a parete in acciaio INOX lucidato a specchio, a 2 funzioni: getto a pioggia e cascata.
5 mm ultra slim stainless steel mirror polished wall showerhead, 2 functions: rain jet and waterfall, 50x25 cm.

CR 15



A566

Soffione doccia a parete 50x20 cm, in acciaio INOX lucidato a specchio.
Stainless steel mirror polished wall shower head 50x20 cm.

CR	15
----	----



A566CA

Soffione doccia a parete 50x20 cm, in acciaio INOX lucidato a specchio, 2 funzioni: a pioggia e cascata.
Stainless steel mirror polished wall shower head, 2 functions: rain jet and waterfall, 50x20 cm.

CR	15
----	----



A564

Soffione doccia ultrapiatto 50x25 cm, a parete in acciaio INOX lucidato a specchio.
Ultra slim stainless steel mirror polished wall shower head 50x25 cm.

CR	15
----	----



A564CA

Soffione doccia ultrapiatto 50x25 cm, a parete in acciaio INOX lucidato a specchio, 2 funzioni: a pioggia e cascata.
Ultra slim stainless steel mirror polished wall shower head, 2 functions: rain jet and waterfall, 50x25 cm.

CR	15
----	----



A565

Soffione doccia ultrapiatto 5mm, 50x25 cm, a parete in acciaio INOX lucidato a specchio.
Ultra slim stainless steel mirror polished wall shower head 50x25 cm.

CR	15
----	----



A565CA

Soffione doccia ultrapiatto 5mm, 50x25 cm, a parete in acciaio INOX lucidato a specchio, a 2 funzioni: getto a pioggia e cascata.
5 mm ultra slim stainless steel mirror polished wall showerhead, 2 functions: rain jet and waterfall, 50x25 cm.

CR	15
----	----

BOX INCASSO
BUILT-IN BOX

WELLNESS
KIT

CROMOTERAPIA
COLOUR THERAPY

SOFFIONI & SOFFIONI A SOFFITTO
SHOWER HEADS & CEILING

BOCCHE
SPOUTS

PANNELLI
PANELS

COLONNE
COLUMNS

SALISCENDI
SLIDING RAILS

DOCCETTE
HAND SHOWERS

OASIS
SHUT-OFF

OUTDOOR

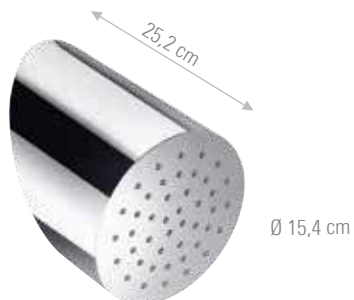

A559XN

Soffione doccia Ø 15,4 cm, lunghezza 25,2 cm, a parete in acciaio INOX lucidato a specchio.

Stainless steel mirror polished wall shower head Ø15,4 cm, length 25,2 cm.

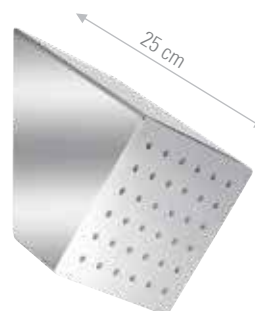

A559XS

Soffione doccia 15,5x15,5 cm, lunghezza 25 cm, a parete in acciaio INOX lucidato a specchio.

Stainless steel mirror polished wall shower head 15,5x15,5 cm, length 25 cm.



A559XP

Soffione doccia inclinato a parete, diametro Ø 5cm, con areatore anticalcare a pioggia, acciaio INOX lucidato a specchio.

Inclined wall-mounted shower head, diameter Ø 5 cm, with rain anti-limescale aerator, stainless steel mirror polished.



A559XA

Soffione doccia a L a parete, diametro Ø 5 cm, con areatore anticalcare a pioggia, acciaio INOX lucidato a specchio.

Wall-mounted L-shaped shower head, diameter Ø 5 cm, with rain anti-limescale aerator, stainless steel mirror polished.

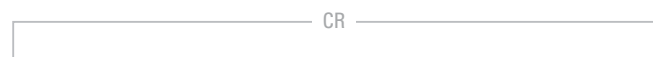

SOFFIONI CON INSTALLAZIONE SU BRACCIO
ARM MOUNTING SHOWER HEAD

SOFFIONI IN ACCIAIO INOX - STAINLESS STEEL SHOWER HEAD



A579H3CM22

Soffione a pioggia quadrato per braccio, 22,5 x 22,5 cm, altezza 3 cm, acciaio INOX lucidato a specchio.

Squared shower head for arm mounting, 22,5 x 22,5 cm height 3cm, mirror polished stainless steel.



A579H3CM32

Soffione a pioggia quadrato per braccio, 32,5 x 32,5 cm, altezza 3 cm, acciaio INOX lucidato a specchio.

Squared shower head for arm mounting, 32,5 x 32,5 cm height 3cm, mirror polished stainless steel.



A578H3CM22

Soffione a pioggia tondo per braccio, diametro Ø 22,5 cm, altezza 3 cm, acciaio INOX lucidato a specchio.

Round shower head for arm mounting, diameter Ø 22,5 cm height 3cm, mirror polished stainless steel.



A578H3CM32

Soffione a pioggia tondo per braccio, diametro Ø 32,5 cm, altezza 3 cm, acciaio INOX lucidato a specchio.

Round shower head for arm mounting, diameter Ø 32,5 cm height 3cm, mirror polished stainless steel.



A578H3CM32

BOX INCASSO
BUILT-IN BOX

WELLNESS
KIT

CROMOTERAPIA
COLOUR THERAPY

SOFFIONI & SOFFIONI A SOFFITTO
SHOWER HEADS & CEILING

BOCCHE
SPOUTS

PANNELLI
PANELS

COLONNE
COLUMN

SALISCENDI
SLIDING RAILS

DOCCETTE
HAND SHOWERS

OASIS
SHUT-OFF

OUTDOOR



Soffione doccia ultra piatto in acciaio INOX lucidato a specchio.
Ultra slim stainless steel mirror polished shower head.

- A578CM20**
Ø 20 cm
- A578CM25**
Ø 25 cm
- A578CM30**
Ø 30 cm
- A578CM40**
Ø 40 cm



Soffione doccia ultra piatto 20x20 cm in acciaio INOX lucidato a specchio.
Ultra slim stainless steel mirror polished shower head 20x20 cm.

- A579CM20**
20x20 cm
- A579CM25**
25x25 cm
- A579CM30**
30x30 cm
- A579CM40**
40x40 cm



Soffione doccia quadrato con angoli arrotondati ultrapiatto in Acciaio Inox lucidato a specchio, con getti in silicone anticalcare.
Squared with rounded corners ultra slim stainless steel mirror polished shower head with anti-limestone silicon jets.

- A577CM20**
20x20 cm
- A577CM25**
25x25 cm
- A577CM30**
30x30 cm
- A577CM40**
40x40 cm



Soffione doccia ultra piatto 33x22 cm in acciaio INOX lucidato a specchio.
Ultra slim stainless steel mirror polished shower head 33x22 cm.

- A579R**



Soffione doccia ultra piatto in acciaio INOX lucidato a specchio, nero opaco.
Ultra slim stainless steel mirror polished shower head, matt black.

- A578CM2015**
Ø 20 cm
- A578CM2515**
Ø 25 cm
- A578CM3015**
Ø 30 cm
- A578CM4015**
Ø 40 cm



Soffione doccia ultra piatto 20x20 cm in acciaio INOX lucidato a specchio, nero opaco.
Ultra slim stainless steel mirror polished shower head 20x20 cm, matt black

- A579CM2015**
20x20 cm
- A579CM2515**
25x25 cm
- A579CM3015**
30x30 cm
- A579CM4015**
40x40 cm

□ □ □ SOFFIONI IN OTTONE - BRASS SHOWER HEAD □ □ □



Soffione a pioggia, cromato, con getti in silicone anticalcare, a snodo, completamente in ottone.
Shower Head, all c.p. brass, with jets in silicone anti-limestone, with ball-joint.

A594
 Ø 20 cm

CR	FIN A	FIN B
----	-------	-------

A594CM30
 Ø 30 cm

CR	FIN A	FIN B
----	-------	-------



A595

Soffione a pioggia piatto, a snodo, Ø35 cm, cromato, con 216 getti in silicone anticalcare, completamente in ottone.
Minimal shower head, all in c.p. brass, Ø35 cm, with 216 jets in silicone anti-limestone, with ball-joint.

CR	FIN A	FIN B
----	-------	-------



A590

Soffione completamente in ottone cromato, con 144 getti in silicone soffice autopulente anticalcare, cm 20x20.
Showerhead completely in c.p. brass, with 144 jets in soft silicon, selfcleaning and anti-limestone, cm 20x20.

CR	FIN A	FIN B
----	-------	-------



A592

Soffione a pioggia rettangolare, a snodo, 24x14, cromo, con 128 getti in silicone anticalcare, completamente in ottone.
Rectangular shower head, all in c.p. brass, 24x14, with 128 jets in silicone anti-limestone, with ball-joint.

CR	FIN A	FIN B
----	-------	-------



A593B

Soffione a pioggia quadrato piatto, a snodo, 30x30, cromo, con 144 getti in silicone anticalcare, completamente in ottone.
Squared shower head, all in c.p. brass, 30x30, with 144 jets in silicone anti-limestone, with ball-joint.

CR	FIN A	FIN B
----	-------	-------



A593

Soffione a pioggia quadrato piatto, a snodo, 35x35, cromo, con 225 getti in silicone anticalcare, completamente in ottone.
Squared shower head, all in c.p. brass, 35x35, with 225 jets in silicone anti-limestone, with ball-joint.

CR	FIN A	FIN B
----	-------	-------



A589

Soffione a pioggia Ø 20 cm, tutto in ottone cromato, con funzione raccoglimento acqua, usati anche in situazione di bassa pressione.
Shower head Ø 20 cm, all in CP brass, used also for low pressure situations.

CR	FIN A	FIN B
----	-------	-------

BOX INCASSO
 BUILT-IN BOX

WELLNESS
 KIT

CROMOTERAPIA
 COLOUR THERAPY

SOFFIONI & SOFFIONI A SOFFITTO
 SHOWER HEADS & CEILING

BOCCHE
 SPOUTS

PANNELLI
 PANELS

COLONNE
 COLUMN

SALISCENDI
 SLIDING RAILS

DOCCETTE
 HAND SHOWERS

OASIS
 SHUT-OFF

OUTDOOR

□ □ □ SOFFIONI IN ABS - ABS SHOWER HEAD □ □ □



Soffione doccia minimale, in ABS lusso, cromato, con getti in silicone autopulenti e anticalcare.
Chrome plated minimal deluxe ABS shower head, with silicon selfcleaning antilimestone jets.

A584CM20

Ø20 cm

A584CM25

Ø25 cm

A584CM30

Ø30 cm

CR

CR

CR



Soffione doccia quadrato, in ABS lusso, cromato, con getti in silicone autopulenti e anticalcare.
Chrome plated square deluxe ABS shower head, with silicon selfcleaning antilimestone jets.

A588SDCM20

20x20 cm

A588SDCM25

25x25 cm

A588SDCM30

30x30 cm

CR

CR

CR



A585EC20

Soffione a pioggia minimale, in ABS cromato, Ø 20 cm, con getti in silicone anticalcare.

C.p. ABS shower head, rain jet, Ø 20 cm, with anti-limestone silicon jets.

CR



A584AD20

Soffione a pioggia squadrato con angoli arrotondati, in ABS cromato, 20x20 cm, con getti in silicone anticalcare.

C.p. ABS squared with rounded corners shower head, rain jet, 20x20 cm, with anti-limestone silicon jets.

CR

□ □ BRACCI DOCCIA - SHOWER ARMS □ □



Braccio doccia quadrato da soffitto, completamente in ottone cromato.
Ceiling square shower arm, completely in chrome plated brass.

A557QCM10

10 cm

A557QCM20

20 cm

A557QCM30

30 cm

A557QCM40

40 cm

A557QCM50

50 cm

CR FIN A FIN B

CR FIN A FIN B

CR FIN A FIN B

CR FIN A FIN B

CR FIN A FIN B



Braccio doccia tondo da soffitto, completamente in ottone cromato.
Ceiling round shower arm, completely in chrome plated brass.

A557CM10

10 cm

A557CM20

20 cm

A557CM30

30 cm

A557CM40

40 cm

A557CM50

50 cm

CR FIN A FIN B

CR FIN A FIN B

CR FIN A FIN B

CR FIN A FIN B

CR FIN A FIN B



Braccio doccia Minimale in ottone cromato con rosetta 1/2Mx1/2M.
CP brass shower arm Minimal, with wall flange 1/2Mx1/2M

A552CM20

20 cm

CR FIN A FIN B

A552CM30

30 cm

CR FIN A FIN B

A552CM40

40 cm

CR FIN A FIN B

A552CM50

50 cm

CR FIN A FIN B



Braccio doccia in ottone cromato con rosetta.
CP brass shower arm, with wall flange.

A553CM30

30 cm

CR FIN A FIN B

A553CM40

40 cm

CR FIN A FIN B



Braccio doccia in ottone cromato con rosetta 1/2Mx1/2M.
C.P. brass tube shower arm, with wall flange 1/2Mx1/2M.

A555CM20

20 cm

CR

A555CM30

30 cm

CR

A555CM40

40 cm

CR



A550

Braccio doccia conico, in ottone cromato.
C.P. brass casted shower arm 1/2.

CR



Braccio doccia quadrato, completo di rosetta quadrata 1/2Mx1/2M, completamente in ottone cromato.
Squared shower arm, complete with square wall flange 1/2Mx1/2M, all in c.p. brass.

A553QCM30

30 cm

CR FIN A FIN B

A553QCM40

40 cm

CR FIN A FIN B



Braccio doccia in ottone cromato con rosetta, 1/2Mx1/2M.
C.P. brass tube shower arm, with wall flange, 1/2Mx1/2M.

A555LCM30

30 cm

CR FIN A FIN B

A555LCM35

35 cm

CR FIN A FIN B

A555LCM40

40 cm

CR FIN A FIN B



A551

Braccio doccia in ottone cromato con rosetta 1/2Mx1/2M lunghezza cm 30.
CP brass shower arm, with wall flange 1/2Mx1/2M length cm 30.

CR



A558

Braccio doccia in ottone cromato, con rosetta, 1/2M x 1/2M.
C.P. Brass tube shower arm, with wall flange, 1/2M x 1/2M.

CR

BOX INCASSO
BUILT-IN BOX

WELLNESS
KIT

CROMOTERAPIA
COLOUR THERAPY

SOFFIONI & SOFFIONI A SOFFITTO
SHOWER HEADS & CEILING

BOCCHE
SPOUTS

PANNELLI
PANELS

COLONNE
COLUMN

SALISCENDI
SLIDING RAILS

DOCCETTE
HAND SHOWERS

OASIS
SHUT-OFF

OUTDOOR



Braccio doccia Minimal in ottone cromato con rosetta e con deviatore integrato e doppia uscita 1/2" per attacco sia del soffione che del flessibile doccia. 1/2MX1/2MX1/2M.

Shower arm Minimal in c.p. chrome with flange, with integrated diverter with double output 1/2" to connect both the showerhead and the shower flexible. 1/2MX1/2MX1/2M.

A552DCM20

20 cm

CR

A552DCM30

30 cm

CR

A552DCM40

40 cm

CR

A552DCM50

50 cm

CR

1

Apri il miscelatore, l'acqua fluirà automaticamente dal soffione.
Open the mixer, the water will automatically flow from the shower head.

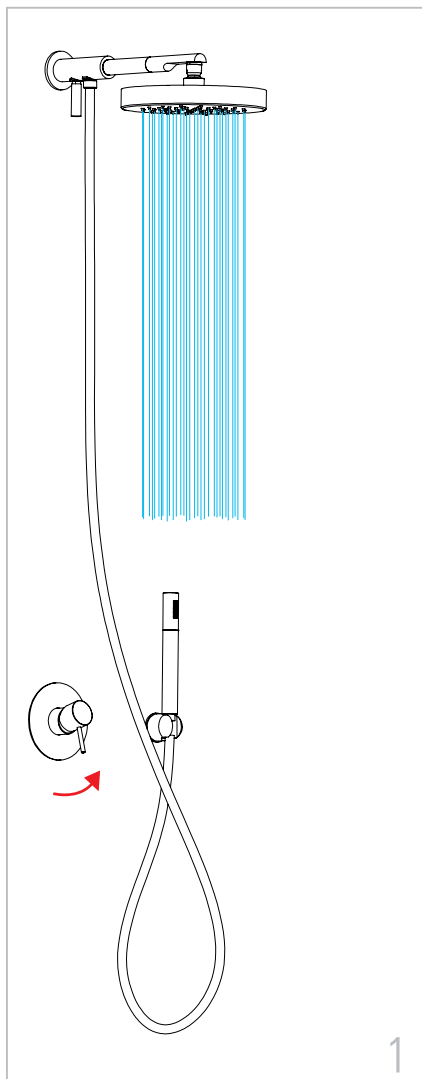

1

2

Apri il miscelatore, spingi verso l'alto la levetta sul braccio doccia, l'acqua fluirà dalla doccetta.
Open the mixer, push the lever on the shower arm upwards, the water will flow from the shower hand.

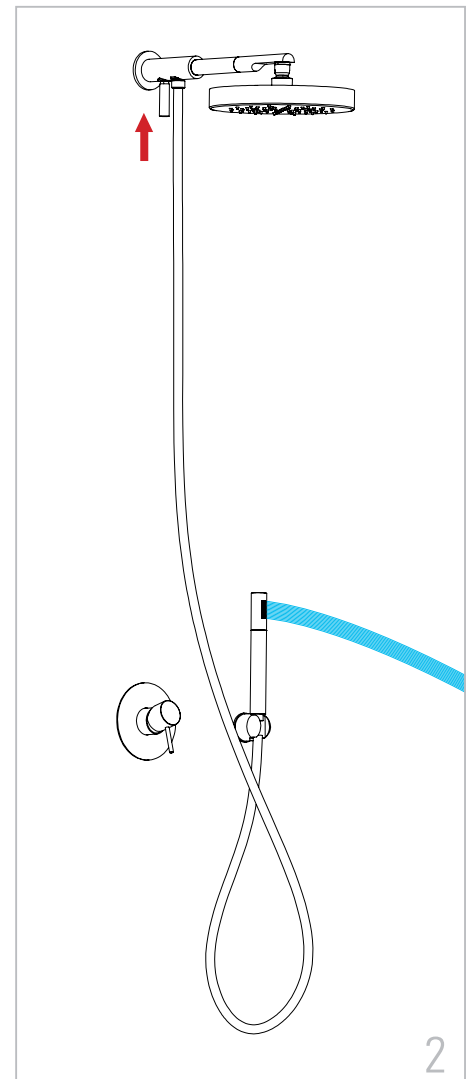

2

BODY JETS



OXJET

Body jet quadrato 4,2x4,2x3,9 cm, in ottone cromato e getti anticalcare.
Squared body jet 4,2x4,2x3,9 cm, in c.p. brass with anti-limestone jets.

CR

FIN A

FIN B



SJET

Body jet rotondo Ø4x3,9 cm, in ottone cromato e getti anticalcare.
Round body jet Ø4x3,9 cm, in c.p. brass with anti-limestone jets.

CR

FIN A

FIN B

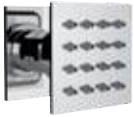

OXJETX

Body jet quadrato 5x5 cm, in acciaio INOX lucidato a specchio per sistema doccia, anticalcare, con snodo.
Squared body jet 5x5 cm, in stainless steel mirror polished for shower systems, antilimestone, with ball-joint.

CR



SJETX

Body jet rotondo Ø5 cm, in acciaio INOX lucidato a specchio per sistema doccia, anticalcare, con snodo.
Round body jet Ø5 cm, in stainless steel mirror polished for shower systems, antilimestone, with ball-joint.

CR



OXJETXB

Body jet da incasso quadrato 5x5 cm, in acciaio INOX lucidato a specchio per sistema doccia, anticalcare.
Built-in squared body jet 5x5 cm, in stainless steel mirror polished for shower systems, antilimestone.

CR



SJETXB

Body jet da incasso rotondo Ø5 cm, in acciaio INOX lucidato a specchio per sistema doccia, anticalcare.
Built-in round body jet Ø5 cm, in stainless steel mirror polished for shower systems, antilimestone.

CR



OXEJETXB

Body jet da incasso quadrato 8x8 cm, in acciaio INOX lucidato a specchio per sistema doccia, anticalcare.
Built-in squared body jet 8x8 cm, in stainless steel mirror polished for shower systems, antilimestone.

CR



OXEJETXBN

Body jet da incasso quadrato con getto nebulizzato, 8x8 cm, in acciaio INOX lucidato a specchio per sistema doccia, anticalcare.
Built-in squared nebulized body jet, 8x8 cm, in stainless steel mirror polished for shower systems, antilimestone.

CR

BOX INCASSO
BUILT-IN BOX

WELLNESS
KIT

CROMOTERAPIA
COLOUR THERAPY

SOFFIONI & SOFFIONI A SOFFITTO
SHOWER HEADS & CEILING

BOCCHE
SPOUTS

PANNELLI
PANELS

COLONNE
COLUMN

SALISCENDI
SLIDING RAILS

DOCCETTE
HAND SHOWERS

OASIS
SHUT-OFF

OUTDOOR

BOCCHE SPOUTS

Bocche da incasso, da appoggio su bordo vasca o con installazione a soffitto per la massima libertà progettuale.

Built-in, deck-mounted or ceiling-mounted spouts for any interior design creativity.

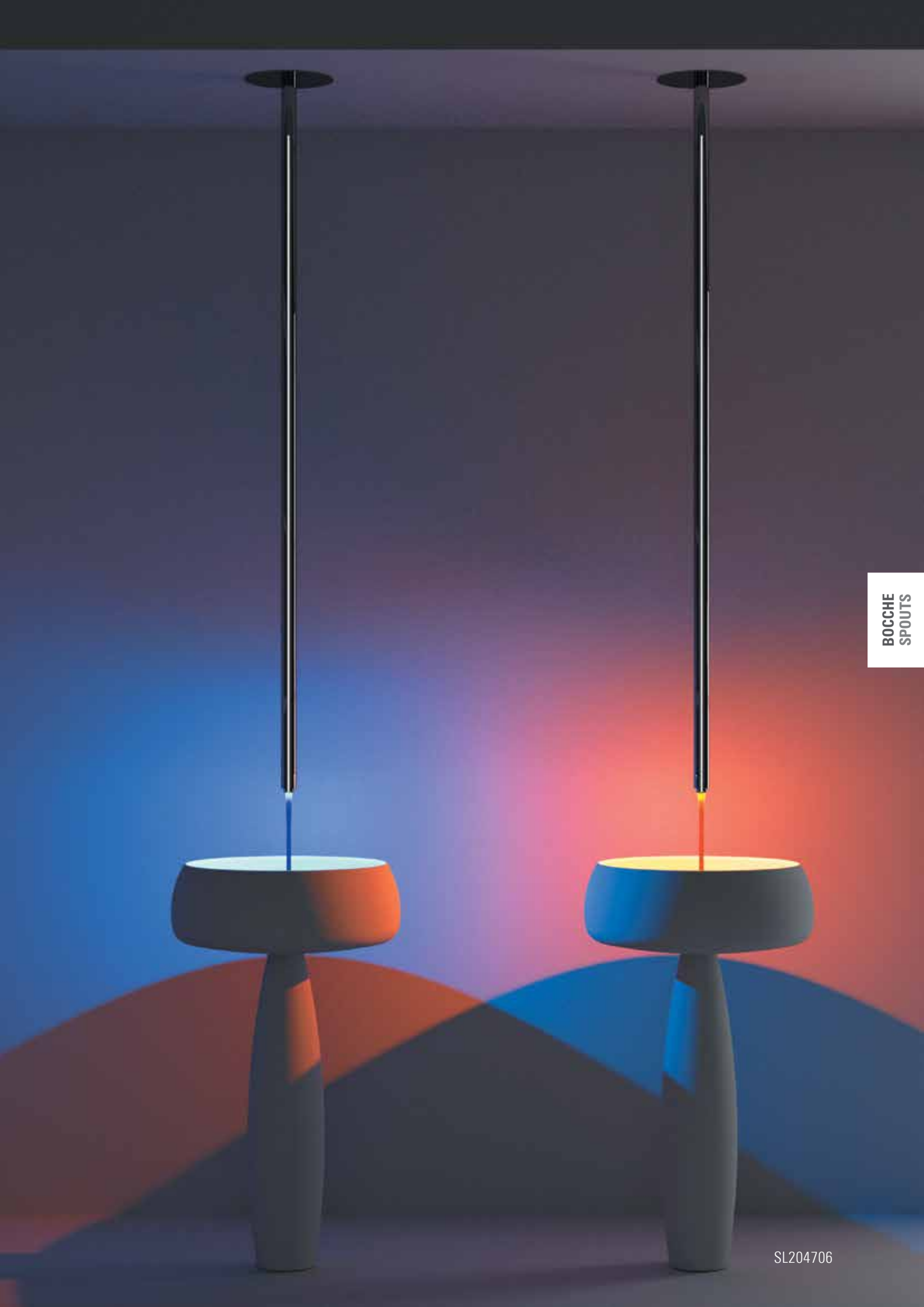

**BOCCHÉ
SPOUTS**

SL204706

BOCCHIE LIGHT ED AMBIENT - AMBIENT AND LIGHT SPOUTS



Bocca da soffitto in ottone cromato con dispositivo color.
Ceiling spout in chrome plated brass with colour device.

SL204706C ●●●●●●●●

lunghezza 166 cm e dispositivo color. Performance led modalità "C".
length 166 cm and colour device. Led performance "C" mode.

CR FIN A FIN B

SL204706XC ●●●●●●●●

lunghezza 181 cm e dispositivo color. Performance led modalità "C".
length 181 cm and colour device. Led performance "C" mode.

CR FIN A FIN B



OXL4704C ●●●●●●●●

Bocca incasso con luce a led. Performance led modalità "C".
Built-in spout with led light cartridge. Led performance "C" mode.

CR FIN A FIN B



SL204704C ●●●●●●●●

Bocca incasso per miscelatore vasca-doccia, con luce a led. Performance led modalità "C".
Built-in spout for bath-shower mixer, with led light cartridge. Led performance "C" mode.

CR FIN A FIN B



La cartuccia COLOR LED è disponibile in 2 diversi modelli tra cui scegliere in base alla prestazione del led preferita.
Nota: in fase di ordine la lettera finale del codice articolo definisce il modello di cartuccia COLOR LED inclusa.

The COLOR LED cartridge is available in 2 different models to choose from based on the preferred LED performance.
Note: when ordering, the final letter in the item code defines the COLOR LED cartridge model included.

C

Il colore della luce cambia con la temperatura dell'acqua (Blu: fino a 28°, Verde: da 28° a 33°, Giallo: da 33° a 38°, Rosso: da 38°).
Le temperature indicate possono variare di circa +/- 2 gradi.

The color of the light changes following the water temperature (Blue: up to 28°, Green: from 28° to 33°, Yellow: from 33° to 38°, Red: from 38°).
Temperatures may vary by approximately +/- 2 degrees.



D

8 colori e sfumature si alternano in un continuo arcobaleno, indipendentemente dalla temperatura.

8 colors and shades alternate in a continuous rainbow, regardless of the temperature.



BOCCHIE BORDO VASCA - DECK BATH SPOUTS



C4705Q

Bocca bordo vasca squadrata con getto a cascata, ottone cromato.
Squared deck-mounted bath spout with waterfall jet, c.p. brass.

CR FIN A FIN B



F4705Q

Bocca bordo vasca squadrata multigetto, ottone cromato
Squared deck-mounted bath spout with multijet, c.p. brass.

CR FIN A FIN B



C4705XQ

Bocca bordo vasca con getto a cascata, acciaio INOX lucidato a specchio
Deck-mounted bath spout with waterfall jet, mirror polished stainless steel.

CR



F4705

Bocca bordo vasca multigetto, ottone cromato
Deck-mounted bath spout with multijet, c.p. brass.

CR FIN A FIN B



C4704

Bocca bordo vasca con getto a cascata.
Deck Bath-shower with waterfall jet.

CR FIN A FIN B

BOCCHE A CASCATA - WATERFALL SPOUTS



A590XJ

Bocca curva a parete con getto a cascata, in acciaio INOX lucidato a specchio.
Curved wall-mounting spout with waterfall jet, mirror polished stainless steel.

CR



A590XQ

Bocca squadrata a parete con getto a cascata, in acciaio INOX lucidato a specchio.
Squared wall-mounting spout with waterfall jet, mirror polished stainless steel.

CR



A590XS

Bocca squadrata a incasso con getto a cascata, in acciaio INOX lucidato a specchio.
Squared built-in spout with waterfall jet, mirror polished stainless steel.

CR



A594XM

Bocca a incasso con getto a cascata, in acciaio INOX lucidato a specchio.
Built-in spout with waterfall jet, mirror polished stainless steel.

CR



A590XL

Bocca a parete a L con getto a cascata, in acciaio INOX lucidato a specchio.
L-shaped wall-mounting spout with waterfall jet, mirror polished stainless steel.

CR

Ø 22,5 cm



A594XT

Bocca rotonda a incasso con getto a cascata, in acciaio INOX lucidato a specchio.
Rounded built-in spout with waterfall jet, mirror polished stainless steel.

CR 15



CA4704

Bocca incasso a cascata.
Built-in spout with waterfall jet.

CR FIN A FIN B



SC4704

Bocca incasso a cascata.
Built-in spout with waterfall.

CR FIN A FIN B

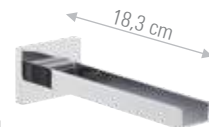

CW4704

Bocca incasso a cascata.
Waterfall built-in spout.

CR FIN A FIN B

BOX INCASSO
BUILT-IN BOX

WELLNESS
KIT

CROMOTERAPIA
COLOUR THERAPY

SOFFIONI & SOFFIONI A SOFFITTO
SHOWER HEADS & CEILING

BOCCHE
SPOUTS

PANNELLI
PANELS

COLONNE
COLUMN

SALISCENDI
SLIDING RAILS

DOCCETTE
HAND SHOWERS

OASIS
SHUT-OFF

OUTDOOR

BOCCHIE - SPOUTS



Bocca da soffitto in ottone cromato.
Ceiling spout in chrome plated brass.

S204706

lunghezza 166 cm.
length 166 cm.

CR FIN A FIN B

S204706X

lunghezza 181 cm.
length 181 cm.

CR FIN A FIN B

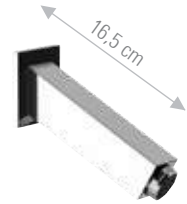

OX4704

Bocca incasso.
Built-in spout.

CR FIN A FIN B



S204704

Bocca incasso per miscelatore vasca-doccia, senza luce a led.
Built-in spout for bath-shower mixer, without led light cartridge.

CR FIN A FIN B

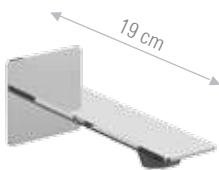

AI4704

Bocca incasso.
Built-in spout.

CR FIN A FIN B

AI4704L

Bocca incasso, lunghezza: 23cm
Built-in spout, length: 23cm

CR FIN A FIN B

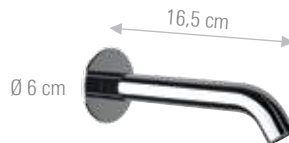

TK4704

Bocca incasso.
Built-in spout.

CR FIN A FIN B

TK4704L

Bocca incasso, lunghezza: 19cm.
Built-in spout, length: 19cm.

CR FIN A FIN B

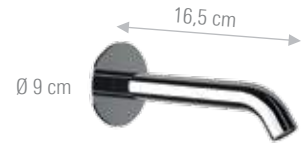

TK4704B

Bocca incasso.
Built-in spout.

CR FIN A FIN B

TK4704BL

Bocca incasso, lunghezza: 19cm.
Built-in spout, length: 19cm.

CR FIN A FIN B

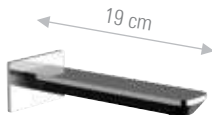

TA4704

Bocca incasso.
Built-in spout.

CR FIN A FIN B

TA4704L

Bocca incasso, lunghezza: 23cm.
Built-in spout, length: 23cm.

CR FIN A FIN B

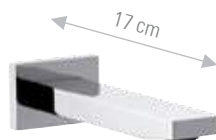

SK4704

Bocca incasso.
Built-in spout.

CR FIN A FIN B

SK4704L

Bocca incasso, lunghezza: 23cm.
Built-in spout, length: 23cm.

CR FIN A FIN B

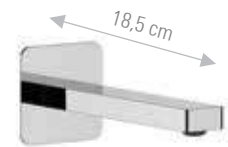

RX4704

Bocca incasso.
Built-in spout.

CR FIN A FIN B

RX4704L

Bocca incasso, lunghezza: 23cm.
Built-in spout, length: 23cm.

CR FIN A FIN B

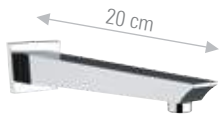

DV4704

Bocca incasso.
Built-in spout.

CR FIN A FIN B

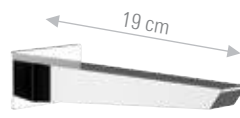

SP4704

Bocca incasso.
Built-in spout.

CR FIN A FIN B

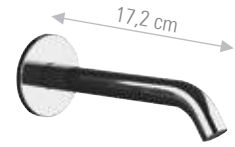

SG4704

Bocca incasso.
Built-in spout.

CR FIN A FIN B

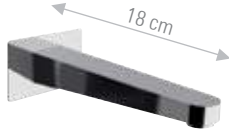

OM4704

Bocca incasso.
Built-in spout.

CR FIN A FIN B



FU4704

Bocca incasso.
Built-in spout.

CR FIN A FIN B



4704

Bocca incasso.
Built-in spout.

CR FIN A FIN B

OM4704L

Bocca incasso, lunghezza: 23cm.
Built-in spout, length: 23cm.

CR FIN A FIN B



BY4704

Bocca incasso.
Built-in spout.

CR FIN A FIN B



L4704

Bocca incasso.
Built-in spout.

CR FIN A FIN B



K4704

Bocca incasso.
Built-in spout.

CR FIN A FIN B

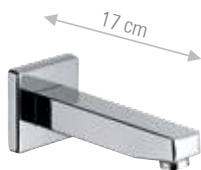

Q4704

Bocca incasso.
Built-in spout.

CR FIN A FIN B

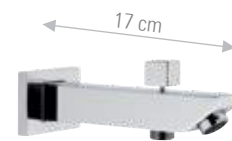

SK4702

Bocca incasso con deviatore integrato.
Built-in spout with diverter.

CR FIN A FIN B

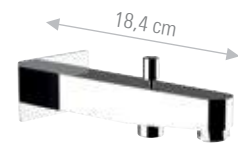

OM4702

Bocca incasso con deviatore integrato.
Built-in spout with diverter.

CR FIN A FIN B



K4702

Bocca incasso con deviatore integrato.
Built-in spout with diverter.

CR FIN A FIN B

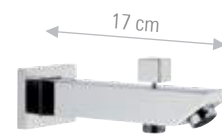

Q4702

Bocca incasso con deviatore integrato.
Built-in spout with diverter.

CR FIN A FIN B



4702

Bocca incasso con deviatore integrato.
Built-in spout with diverter.

CR FIN A FIN B

BOX INCASSO
BUILT-IN BOX

WELLNESS
KIT

CROMOTERAPIA
COLOUR THERAPY

SOFFIONI & SOFFIONI A SOFFITTO
SHOWER HEADS & CEILING

BOCCHE
SPOUTS

PANNELLI
PANELS

COLONNE
COLUMNS

SALISCENDI
SLIDING RAILS

DOCCETTE
HAND SHOWERS

OASIS
SHUT-OFF

OUTDOOR

PANNELLI DOCCIA SHOWER PANELS

Pannelli per doccia completi per installazione a incasso a parete, disponibili sia con miscelazione termostatica che tradizionale.

Complete shower panels for built-in wall installation, available with both thermostatic and traditional mixing.



PANNELLI
PANEL

A242CM20

PANNELLI DOCCIA - SHOWER PANELS

**A242CM20**

Pannello doccia a parete, monocomando con deviatore a 2 vie, in acciaio INOX lucidato a specchio, getto a pioggia anti-calcare, doccetta anti-calcare in ABS cromato, flessibile in PVC da 150 cm.

Stainless steel mirror polished wall mounted shower panel, single lever with 2 ways diverter, rain jet with anti-limestone system, c.p. ABS hand shower with anti-limestone system, PVC flexible hose 150 cm.

CR

**A242CM20J**

Pannello doccia a parete, monocomando con deviatore a 3 vie, in acciaio INOX lucidato a specchio, getto a pioggia anti-calcare, body jets anti-calcare, doccetta anti-calcare in ABS cromato, flessibile in PVC da 150 cm.

Stainless steel mirror polished wall mounted shower panel, single lever with 3 ways diverter, rain jet with anti-limestone system, anti-limestone body jets, c.p. ABS hand shower with anti-limestone system, PVC flexible hose 150 cm.

CR

**A242CM20JC**

Pannello doccia a parete, monocomando con deviatore a 4 vie, in acciaio INOX lucidato a specchio, getto a pioggia anti-calcare e getto a cascata, body jets anti-calcare, doccetta anti-calcare in ABS cromato, flessibile in PVC da 150 cm.

Stainless steel mirror polished wall mounted shower panel, single lever with 4 ways diverter, rain jet with anti-limestone system, waterfall jet, anti-limestone body jets, c.p. ABS hand shower with anti-limestone system, PVC flexible hose 150 cm.

CR

PANNELLI DOCCIA TERMOSTATICI - THERMOSTATIC SHOWER PANELS



A242TCM20



Pannello doccia a parete termostatico coassiale, monocomando con deviatore a 2 vie, in acciaio INOX lucidato a specchio, getto a pioggia anti-calcare, doccetta anti-calcare in ABS cromato, flessibile in PVC da 150 cm.

Stainless steel mirror polished wall mounted thermostatic coaxial shower panel, single lever with 2 ways diverter, rain jet with anti-limestone system, c.p. ABS hand shower with anti-limestone system, PVC flexible hose 150 cm.

CR



A242TCM20J

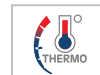

Pannello doccia a parete termostatico, monocomando con deviatore a 3 vie, in acciaio INOX lucidato a specchio, getto a pioggia anti-calcare, body jets anti-calcare, doccetta anti-calcare in ABS cromato, flessibile in PVC da 150 cm.

Stainless steel mirror polished wall mounted thermostatic shower panel, single lever with 3 ways diverter, rain jet with anti-limestone system, anti-limestone system body jets, c.p. ABS hand shower with anti-limestone system, PVC flexible hose 150 cm.

CR



A242TCM20JC

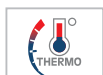

Pannello doccia a parete termostatico, monocomando con deviatore a 4 vie, in acciaio INOX lucidato a specchio, getto a pioggia anti-calcare e getto a cascata, body jets anti-calcare, doccetta anti-calcare in ABS cromato, flessibile in PVC da 150 cm.

Stainless steel mirror polished wall mounted thermostatic shower panel, single lever with 4 ways diverter, rain jet with anti-limestone system, waterfall jet, anti-limestone body jets, c.p. ABS hand shower with anti-limestone system, PVC flexible hose 150 cm.

CR

BOX INCASSO
BUILT-IN BOX

WELLNESS
KIT

CROMOTERAPIA
COLOUR THERAPY

SOFFIONI & SOFFIONI A SOFFITTO
SHOWER HEADS & CEILING

BOCCHE
SPOUTS

PANNELLI
PANEL

COLONNE
COLUMN

SALISCENDI
SLIDING RAILS

DOCCETTE
HAND SHOWERS

OASIS
SHUT-OFF

OUTDOOR

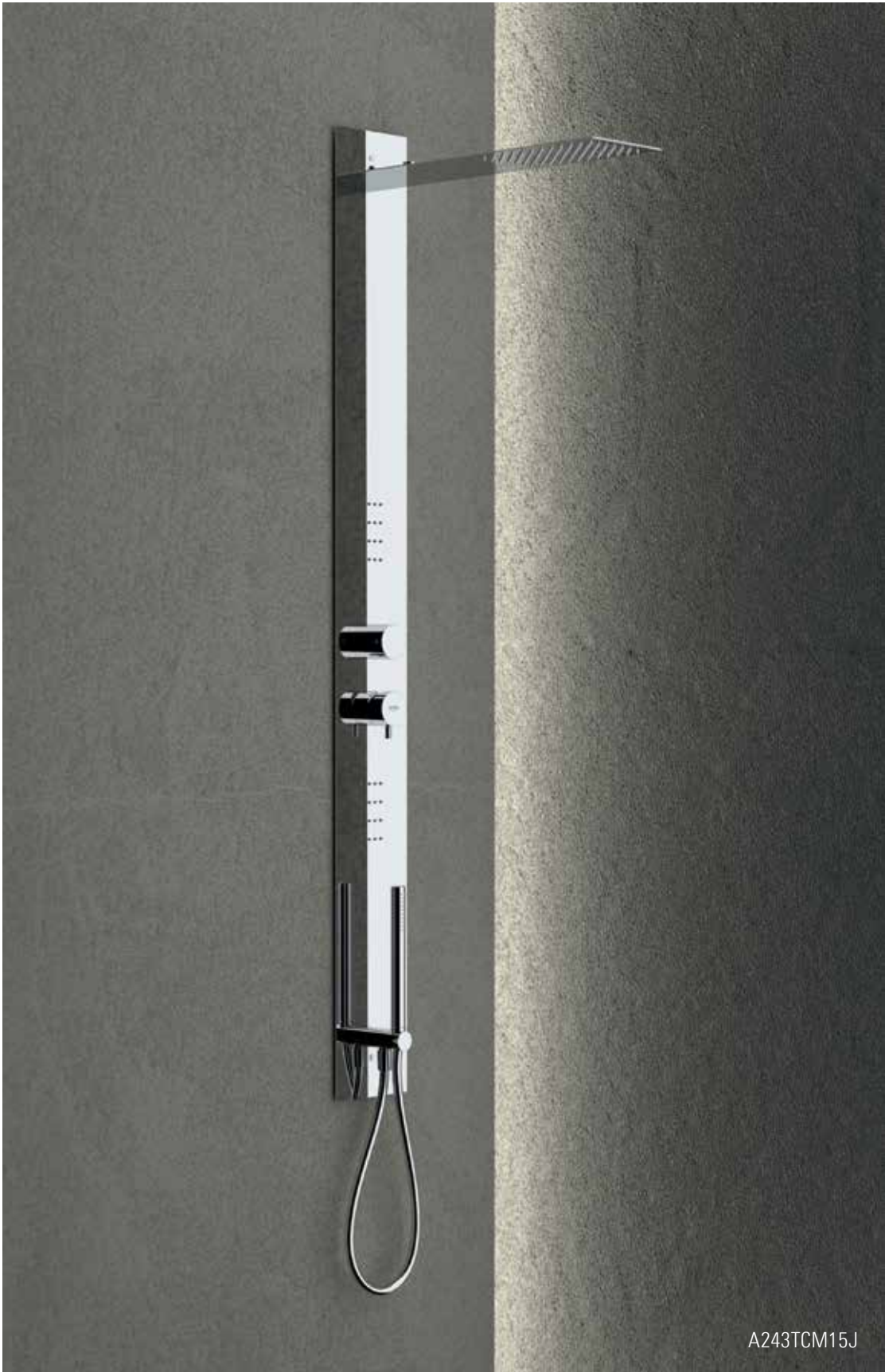

A243TCM15J

PANNELLI DOCCIA AD INCASSO - BUILT-IN SHOWER PANELS



A243CM15J

Pannello doccia ad incasso, monocomando con deviatore a 3 vie, in acciaio INOX lucidato a specchio, getto a pioggia anti-calcare, body jets anti-calcare, doccetta anti-calcare in ABS cromato, flessibile in PVC da 150 cm.
Stainless steel mirror polished wall mounted shower panel, single lever with 3 ways diverter, rain jet with anti-limestone system, anti-limestone system body jets, c.p. ABS hand shower with anti-limestone system, PVC flexible hose 150 cm.

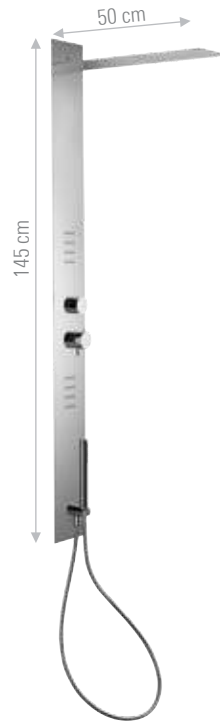

A243TCM15J

Pannello doccia ad incasso termostatico, monocomando con deviatore a 3 vie, in acciaio INOX lucidato a specchio, getto a pioggia anti-calcare, body jets anti-calcare, doccetta anti-calcare in ABS cromato, flessibile in PVC da 150 cm.
Stainless steel mirror polished wall mounted thermostatic shower panel, single lever with 3 ways diverter, rain jet with anti-limestone system, anti-limestone system body jets, c.p. ABS hand shower with anti-limestone system, PVC flexible hose 150 cm.

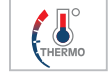

A243TCM15JC

Pannello doccia ad incasso termostatico, monocomando con deviatore a 4 vie, in acciaio INOX lucidato a specchio, getto a pioggia anti-calcare, getto cascata, body jets anti-calcare, doccetta anti-calcare in ABS cromato, flessibile in PVC da 150 cm.
Stainless steel mirror polished wall mounted thermostatic shower panel, single lever with 4 ways diverter, rain jet with anti-limestone system, waterfall jet, anti-limestone system body jets, c.p. ABS hand shower with anti-limestone system, PVC flexible hose 150 cm.

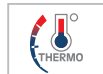

BOX INCASSO
BUILT-IN BOX

WELLNESS
KIT

CROMOTERAPIA
COLOUR THERAPY

SOFFIONI & SOFFIONI A SOFFITTO
SHOWER HEADS & CEILING

BOCCHE
SPOUTS

PANNELLI
PANEL

COLONNE
COLUMN

SALISCENDI
SLIDING RAILS

DOCCETTE
HAND SHOWERS

OASIS
SHUT-OFF

OUTDOOR

COLONNE DOCCIA SHOWER COLUMNS

Le colonne doccia sono una soluzione con miscelatore esterno per l'ambiente doccia. Disponibili in tante diverse composizioni complete per assecondare ogni preferenza estetica e funzionale.

The shower columns are a solution with an external mixer for the shower environment. Available in many different complete sets to satisfy every aesthetic and functional preference.



COLONNE
COLUMN

S636RX435594CR

COLONNE DOCCIA TONDE - ROUNDED SHOWER COLUMN



Set colonna doccia, composto da: miscelatore esterno per colonna, colonna con fissaggio superiore regolabile e deviatore, flessibile 150cm, soffione Ø 20cm in abs, doccetta in ABS a 4 funzioni con pulsante per il cambio dell'intensità.
Shower column set, including: exposed mixer for column, column with adjustable upper fixing and diverter, 150cm flexible hose, abs shower head, 4-function abs hand shower with button for jets mode switching.

S636RX3MP8420
 Con soffione doccia Ø20cm
 With shower head Ø20cm

CR

S636RX3MP8425
 Con soffione doccia Ø25cm
 With shower head Ø25cm

CR

S636RX3MP8430
 Con soffione doccia Ø30cm
 With shower head Ø30cm

CR



Set colonna doccia, composto da: miscelatore esterno per colonna, colonna con fissaggio superiore regolabile e deviatore, flessibile 150cm, soffione in abs, doccetta in ABS a 3 funzioni con pulsante per il cambio dell'intensità.
Shower column set, including: exposed mixer for column, column with adjustable upper fixing and diverter, 150cm flexible hose, abs shower head, 3-function abs hand shower with button for jets mode switching.

S636RX3CPSD20
 Con soffione doccia 20x20cm
 With shower head 20x20cm

CR

S636RX3CPSD25
 Con soffione doccia 25x25cm
 With shower head 25x25cm

CR

S636RX3CPSD30
 Con soffione doccia 30x30cm
 With shower head 30x30cm

CR



Set colonna doccia, composto da: miscelatore esterno per colonna, colonna con fissaggio superiore regolabile e deviatore, flessibile 150cm, soffione ultra piatto Ø20cm in acciaio INOX lucidato a specchio, doccetta in ABS a 4 funzioni con pulsante per il cambio dell'intensità.
Shower column set, including: exposed mixer for column, column with adjustable upper fixing and diverter, 150cm flexible hose, ultra-flat shower head in mirror-polished stainless steel, 4-function abs hand shower with button for jets mode switching.

S636RX3MP7820
 Con soffione doccia Ø20cm
 With shower head Ø20cm

CR 15

S636RX3MP7825
 Con soffione doccia Ø25cm
 With shower head Ø25cm

CR 15

S636RX3MP7830
 Con soffione doccia Ø30cm
 With shower head Ø30cm

CR 15



Set colonna doccia, composto da: miscelatore esterno per colonna, colonna con fissaggio superiore regolabile e deviatore, flessibile 150cm, soffione ultra piatto in acciaio INOX lucidato a specchio, doccetta in ABS a 3 funzioni con pulsante per il cambio dell'intensità.
Shower column set, including: exposed mixer for column, column with adjustable upper fixing and diverter, 150cm flexible hose, ultra-flat 20x20cm shower head in mirror-polished stainless steel, 3-function abs hand shower with button for jets mode switching.

S636RX3CP7920
 Con soffione doccia 20x20cm
 With shower head 20x20cm

CR 15

S636RX3CP7925
 Con soffione doccia 25x25cm
 With shower head 25x25cm

CR 15

S636RX3CP7930
 Con soffione doccia 30x30cm
 With shower head 30x30cm

CR 15

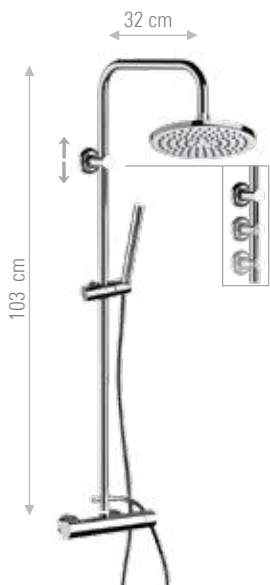

Set colonna doccia, composto da: miscelatore esterno per colonna, colonna con fissaggio superiore regolabile e deviatore, flessibile 150cm, soffione in ottone, doccetta in ottone a 1 funzione.

Shower column set, including: exposed mixer for column, column with adjustable upper fixing and diverter, 150cm flexible hose, brass shower head, 1-function brass hand shower,

S636RX435594CR

Con soffione doccia Ø20cm
With shower head Ø20cm

CR	FIN A	FIN B
----	-------	-------

S636RX4359430CR

Con soffione doccia Ø30cm
With shower head Ø30cm

CR	FIN A	FIN B
----	-------	-------

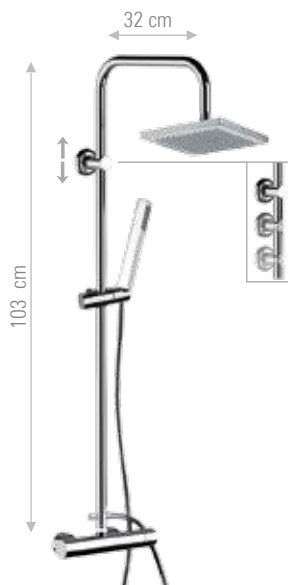

Set colonna doccia, composto da: miscelatore esterno per colonna, colonna con fissaggio superiore regolabile e deviatore, flessibile 150cm, soffione 20x20cm in ottone, doccetta quadrata in ottone a 1 funzione.

Shower column set, including: exposed mixer for column, column with adjustable upper fixing and diverter, 150cm flexible hose, brass shower head, 1-function squared brass hand shower.

S636RX495590CR

Con soffione doccia 20x20cm
With shower head 20x20cm

CR	FIN A	FIN B
----	-------	-------

S636RX49593BCR

Con soffione doccia 30x30cm
With shower head 30x30cm

CR	FIN A	FIN B
----	-------	-------

BOX INCASSO
BUILT-IN BOX

WELLNESS
KIT

CROMOTERAPIA
COLOUR THERAPY

SOFFIONI & SOFFIONI A SOFFITTO
SHOWER HEADS & CEILING

BOCCHE
SPOUTS

PANNELLI
PANELS

**COLONNE
COLUMN**

SALISCENDI
SLIDING RAILS

DOCCETTE
HAND SHOWERS

OASIS
SHUT-OFF

OUTDOOR

COLONNE DOCCIA TONDE TELESCOPICHE
ROUNDED TELESCOPIC SHOWER COLUMN



Set colonna doccia, composto da: miscelatore esterno per colonna, colonna con fissaggio superiore regolabile e deviatore, flessibile 150cm, soffione in abs, doccetta in ABS a 4 funzioni con pulsante per il cambio dell'intensità.
Shower column set, including: exposed mixer for column, column with adjustable upper fixing and diverter, 150cm flexible hose, abs shower head, 4-function abs hand shower with button for jets mode switching.

S636RA3MP8420
Con soffione doccia Ø20cm
With shower head Ø20cm

CR

S636RA3MP8425
Con soffione doccia Ø25cm
With shower head Ø25cm

CR

S636RA3MP8430
Con soffione doccia Ø30cm
With shower head Ø30cm

CR



Set colonna doccia, composto da: miscelatore esterno per colonna, colonna con fissaggio superiore regolabile e deviatore, flessibile 150cm, soffione 20x20cm in abs, doccetta in ABS a 3 funzioni con pulsante per il cambio dell'intensità.
Shower column set, including: exposed mixer for column, column with adjustable upper fixing and diverter, 150cm flexible hose, abs shower head, 3-function abs hand shower with button for jets mode switching.

S636RA3CPSD20
Con soffione doccia 20x20cm
With shower head 20x20cm

CR

S636RA3CPSD25
Con soffione doccia 25x25cm
With shower head 25x25cm

CR

S636RA3CPSD30
Con soffione doccia 30x30cm
With shower head 30x30cm

CR



Set colonna doccia, composto da: miscelatore esterno per colonna, colonna con fissaggio superiore regolabile e deviatore, flessibile 150cm, soffione ultra piatto in acciaio INOX lucidato a specchio, doccetta in ABS a 4 funzioni con pulsante per il cambio dell'intensità.
Shower column set, including: exposed mixer for column, column with adjustable upper fixing and diverter, 150cm flexible hose, ultra-flat shower head in mirror-polished stainless steel, 4-function abs hand shower with button for jets mode switching.

S636RA3MP7820
Con soffione doccia Ø20cm
With shower head Ø20cm

CR 15

S636RA3MP7825
Con soffione doccia Ø25cm
With shower head Ø25cm

CR 15

S636RA3MP7830
Con soffione doccia Ø30cm
With shower head Ø30cm

CR 15



Set colonna doccia, composto da: miscelatore esterno per colonna, colonna con fissaggio superiore regolabile e deviatore, flessibile 150cm, soffione ultra piatto in acciaio INOX lucidato a specchio, doccetta in ABS a 3 funzioni con pulsante per il cambio dell'intensità.
Shower column set, including: exposed mixer for column, column with adjustable upper fixing and diverter, 150cm flexible hose, ultra-flat shower head in mirror-polished stainless steel, 3-function abs hand shower with button for jets mode switching.

S636RA3CP7920
Con soffione doccia 20x20cm
With shower head 20x20cm

CR 15

S636RA3CP7925
Con soffione doccia 25x25cm
With shower head 25x25cm

CR 15

S636RA3CP7930
Con soffione doccia 30x30cm
With shower head 30x30cm

CR 15



Set colonna doccia, composto da: miscelatore esterno per colonna, colonna con fissaggio superiore regolabile e deviatore, flessibile 150cm, soffione in ottone, doccetta in ottone a 1 funzione.
Shower column set, including: exposed mixer for column, column with adjustable upper fixing and diverter, 150cm flexible hose, Ø 20cm brass shower head, 1-function brass hand shower.

S636RA435594CR

Con soffione doccia Ø20cm
 With shower head Ø20cm

CR _____ FIN A _____ FIN B _____

S636RA4359430CR

Con soffione doccia Ø30cm
 With shower head Ø30cm

CR _____ FIN A _____ FIN B _____



Set colonna doccia, composto da: miscelatore esterno per colonna, colonna con fissaggio superiore regolabile e deviatore, flessibile 150cm, soffione in ottone, doccetta quadrata in ottone a 1 funzione.
Shower column set, including: exposed mixer for column, column with adjustable upper fixing and diverter, 150cm flexible hose, brass shower head, 1-function squared brass hand shower.

S636RA495590CR

Con soffione doccia 20x20cm
 With shower head 20x20cm

CR _____ FIN A _____ FIN B _____

S636RA49593BCR

Con soffione doccia 30x30cm
 With shower head 30x30cm

CR _____ FIN A _____ FIN B _____

BOX INCASSO
 BUILT-IN BOX

WELLNESS
 KIT

CROMOTERAPIA
 COLOUR THERAPY

SOFFIONI & SOFFIONI A SOFFITTO
 SHOWER HEADS & CEILING

BOCCHE
 SPOUTS

PANNELLI
 PANELS

COLONNE
COLUMN

SALISCENDI
 SLIDING RAILS

DOCCETTE
 HAND SHOWERS

OASIS
 SHUT-OFF

OUTDOOR

COLONNE DOCCIA QUADRATE - SQUARED SHOWER COLUMN



Set colonna doccia, composto da: miscelatore esterno per colonna SKYLINE, colonna con fissaggio superiore regolabile e deviatore, flessibile 150cm, soffione ultra piatto in acciaio INOX lucidato a specchio, doccetta in ABS a 3 funzioni con pulsante per il cambio dell'intensità.
Shower column set, including: exposed mixer for column SKYLINE, column with adjustable upper fixing and diverter, 150cm flexible hose, ultra-flat shower head in mirror-polished stainless steel 3-function abs hand shower with button for jets mode switching.

SK636X3CP7920
 Con soffione doccia Ø20cm
 With shower head Ø20cm

CR 15

SK636X3CP7925
 Con soffione doccia Ø25cm
 With shower head Ø25cm

CR 15

SK636X3CP7930
 Con soffione doccia Ø30cm
 With shower head Ø30cm

CR 15



Set colonna doccia, composto da: miscelatore esterno per colonna SKYLINE, colonna telescopica ad altezza regolabile con deviatore, flessibile doccia 150cm, soffione ultra piatto in acciaio INOX lucidato a specchio, doccetta in ABS a 3 funzioni con pulsante per il cambio dell'intensità,
Shower column set, including: exposed mixer for column SKYLINE, height-adjustable telescopic column with diverter, 150cm flexible hose, ultra-flat shower head in mirror-polished stainless steel, 3-function abs hand shower with button for jets mode switching.

SK636A3CP7920
 Con soffione doccia 20x20cm
 With shower head 20x20cm

CR 15

SK636A3CP7925
 Con soffione doccia 25x25cm
 With shower head 25x25cm

CR 15

SK636A3CP7930
 Con soffione doccia 30x30cm
 With shower head 30x30cm

CR 15



Set colonna doccia, composto da: miscelatore esterno per colonna SKYLINE, colonna doccia squadrata con deviatore, flessibile doccia 150cm, soffione in ottone, doccetta quadrata in ottone a 1 funzione.
Shower column set, including: exposed mixer for column SKYLINE, squared column with diverter and 150cm flexible hose, brass shower head, 1-function squared brass hand shower.

SK636Q590CR
 Con soffione doccia 20x20cm
 With shower head 20x20cm

CR FIN A FIN B

SK636Q93BCR
 Con soffione doccia 30x30cm
 With shower head 30x30cm

CR FIN A FIN B

COLONNE DOCCIA CON LEVA FRONTALE - SHOWER COLUMN WITH FRONT LEVER



Set colonna doccia, composto da: miscelatore esterno per colonna SMART, colonna con fissaggio superiore regolabile e deviatore, flessibile 150cm, soffione ultra piatto in acciaio INOX lucidato a specchio, doccetta in ABS a 4 funzioni con pulsante per il cambio dell'intensità, Shower column set, including: exposed mixer for column SMART, column with adjustable upper fixing and diverter, 150cm flexible hose, ultra-flat shower head in mirror-polished stainless steel, 4-function abs hand shower with button for jets mode switching.

SR636X3MP7820

Con soffione doccia Ø20cm
With shower head Ø20cm

CR 15

SR636X3MP7825

Con soffione doccia Ø25cm
With shower head Ø25cm

CR 15

SR636X3MP7830

Con soffione doccia Ø30cm
With shower head Ø30cm

CR 15



Set colonna doccia, composto da: miscelatore esterno per colonna SMART, colonna telescopica ad altezza regolabile con deviatore, flessibile doccia 150cm, soffione ultra piatto in acciaio INOX lucidato a specchio, doccetta in ABS a 4 funzioni con pulsante per il cambio dell'intensità, Shower column set, including: exposed mixer for column SMART, height-adjustable telescopic column with diverter, 150cm flexible hose, ultra-flat shower head in mirror-polished stainless steel, 4-function abs hand shower with button for jets mode switching.

SR636A3MP7820

Con soffione doccia Ø20cm
With shower head Ø20cm

CR 15

SR636A3MP7825

Con soffione doccia Ø25cm
With shower head Ø25cm

CR 15

SR636A3MP7830

Con soffione doccia Ø30cm
With shower head Ø30cm

CR 15



Set colonna doccia, composto da: miscelatore esterno per colonna REFLEX, colonna con fissaggio superiore regolabile e deviatore, flessibile 150cm, soffione ultra piatto in acciaio INOX lucidato a specchio, doccetta in ABS a 3 funzioni con pulsante per il cambio dell'intensità. Shower column set, including: exposed mixer for column REFLEX, column with adjustable upper fixing and diverter, 150cm flexible hose, ultra-flat shower head in mirror-polished stainless steel 3-function abs hand shower with button for jets mode switching,

RX636X3CP7920

Con soffione doccia 20x20cm
With shower head 20x20cm

CR 15

RX636X3CP7925

Con soffione doccia 25x25cm
With shower head 25x25cm

CR 15

RX636X3CP7930

Con soffione doccia 30x30cm
With shower head 30x30cm

CR 15



Set colonna doccia, composto da: miscelatore esterno per colonna REFLEX, colonna telescopica ad altezza regolabile con deviatore, flessibile doccia 150cm, soffione ultra piatto in acciaio INOX lucidato a specchio, doccetta in ABS a 3 funzioni con pulsante per il cambio dell'intensità. Shower column set, including: exposed mixer for column REFLEX, height-adjustable telescopic column with diverter, 150cm flexible hose, ultra-flat shower head in mirror-polished stainless steel, 3-function abs hand shower with button for jets mode switching.

RX636A3CP7920

Con soffione doccia 20x20cm
With shower head 20x20cm

CR 15

RX636A3CP7925

Con soffione doccia 25x25cm
With shower head 25x25cm

CR 15

RX636A3CP7930

Con soffione doccia 30x30cm
With shower head 30x30cm

CR 15

BOX INCASSO
BUILT-IN BOX

WELLNESS
KIT

CROMOTERAPIA
COLOUR THERAPY

SOFFIONI & SOFFIONI A SOFFITTO
SHOWER HEADS & CEILING

BOCCHE
SPOUTS

PANNELLI
PANELS

COLONNE
COLUMN

SALISCENDI
SLIDING RAILS

DOCCETTE
HAND SHOWERS

OASIS
SHUT-OFF

OUTDOOR

COLONNE 3 VIE TELESCOPICHE - 3-WAYS TELESCOPIC SHOWER COLUMN



Set colonna vasca/doccia a 3 vie, composto da: miscelatore esterno vasca/doccia per colonna con deviatore SMART, colonna telescopica ad altezza regolabile, soffione ultra piatto Ø20cm in acciaio INOX lucidato a specchio, doccetta in ABS a 4 funzioni con pulsante per il cambio dell'intensità, flessibile 150cm.
3-way bath/shower column set, including: exposed bath/shower mixer for column with diverter SMART, height-adjustable telescopic column, ultra-flat shower head in mirror-polished stainless steel, 4-function abs hand shower with button for jets mode switching, 150cm flexible hose.

SR636DA3MP7820

Con soffione doccia Ø20cm
 With shower head Ø20cm

CR 15

SR636DA3MP7825

Con soffione doccia Ø25cm
 With shower head Ø25cm

CR 15

SR636DA3MP7830

Con soffione doccia Ø30cm
 With shower head Ø30cm

CR 15



Set colonna vasca/doccia a 3 vie, composto da: miscelatore esterno vasca/doccia per colonna con deviatore REFLEX, colonna telescopica ad altezza regolabile, soffione ultra piatto in acciaio INOX lucidato a specchio, doccetta in ABS a 3 funzioni con pulsante per il cambio dell'intensità, flessibile 150cm.
3-way bath/shower column set, including: exposed bath/shower mixer for column with diverter REFLEX, height-adjustable telescopic column, ultra-flat shower head in mirror-polished stainless steel, 3-function abs hand shower with button for jets mode switching, 150cm flexible hose.

RX636DA3CP7920

Con soffione doccia 20x20cm
 With shower head 20x20cm

CR 15

RX636DA3CP7925

Con soffione doccia 25x25cm
 With shower head 25x25cm

CR 15

RX636DA3CP7930

Con soffione doccia 30x30cm
 With shower head 30x30cm

CR 15

COLONNE DOCCIA CON ATTACCO ESTERNO SHOWER COLUMNS WITH EXTERNAL CONNECTION



BOX INCASSO
BUILT-IN BOX

WELLNESS
KIT

CROMOTERAPIA
COLOUR THERAPY

SOFFIONI & SOFFIONI A SOFFITTO
SHOWER HEADS & CEILING

BOCCHIE
SPOUTS

PANNELLI
PANELS

COLONNE
COLUMN

SALISCENDI
SLIDING RAILS

DOCCETTE
HAND SHOWERS

OASIS
SHUT-OFF

OUTDOOR

WELLNESS

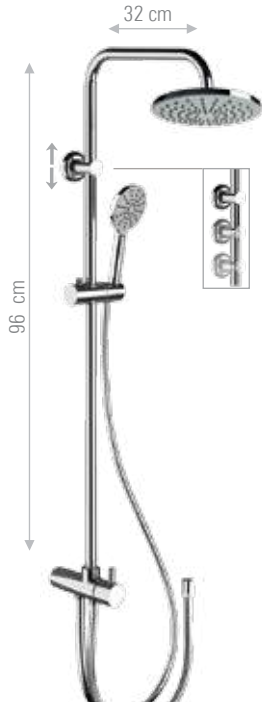

Set colonna doccia con presa acqua esterna, composto da: supporto a muro per colonna con deviatore integrato e presa acqua inferiore, colonna con fissaggio superiore regolabile, soffione Ø 20cm in abs, doccetta in ABS a 4 funzioni con pulsante per il cambio dell'intensità, flessibile di collegamento 50cm, flessibile 150cm.

Shower column set for external water intake, including: wall fixing for column with water connection and diverter, column with adjustable upper fixing, Ø 20cm abs shower head, 4-function abs hand shower with button for jets mode switching, connection hose 50cm, 150cm flexible hose.

A2023MP84207SU

Con soffione doccia 20x20cm
With shower head 20x20cm

A2023MP84257SU

Con soffione doccia 25x25cm
With shower head 25x25cm

A2023MP84307SU

Con soffione doccia 30x30cm
With shower head 30x30cm

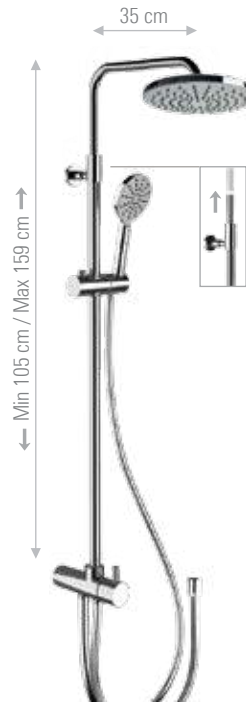

Set colonna doccia con presa acqua esterna, composto da: supporto a muro per colonna con deviatore integrato e presa acqua inferiore, colonna telescopica ad altezza regolabile, soffione in abs, doccetta in ABS a 4 funzioni con pulsante per il cambio dell'intensità, flessibile di collegamento 50cm, flessibile 150cm.

Shower column set for external water intake, including: wall fixing for column with water connection and diverter, height-adjustable telescopic column, abs shower head, 4-function abs hand shower with button for jets mode switching, connection hose 50cm, 150cm flexible hose.

A2063MP84207SU

Con soffione doccia Ø20cm
With shower head Ø20cm

A2063MP84257SU

Con soffione doccia Ø25cm
With shower head Ø25cm

A2063MP84307SU

Con soffione doccia Ø30cm
With shower head Ø30cm



Set colonna doccia con presa acqua esterna, composto da: supporto a muro per colonna con deviatore integrato e presa acqua inferiore, colonna con fissaggio superiore regolabile, soffione 20x20cm in abs, doccetta in ABS a 3 funzioni con pulsante per il cambio dell'intensità, flessibile di collegamento 50cm, flessibile 150cm.

Shower column set for external water intake, including: wall fixing for column with water connection and diverter, column with adjustable upper fixing, abs shower head, 3-function abs hand shower with button for jets mode switching, connection hose 50cm, 150cm flexible hose.

A2023CPSD207SU

Con soffione doccia 20x20cm
With shower head 20x20cm

A2023CPSD257SU

Con soffione doccia 25x25cm
With shower head 25x25cm

A2023CPSD307SU

Con soffione doccia 30x30cm
With shower head 30x30cm



Set colonna doccia con presa acqua esterna, composto da: supporto a muro per colonna con deviatore integrato e presa acqua inferiore, colonna telescopica ad altezza regolabile, soffione in abs, doccetta in ABS a 3 funzioni con pulsante per il cambio dell'intensità, flessibile di collegamento 50cm, flessibile 150cm.

Shower column set for external water intake, including: wall fixing for column with water connection and diverter, height-adjustable telescopic column, 20x20cm abs shower head, 3-function abs hand shower with button for jets mode switching, connection hose 50cm, 150cm flexible hose.

A2063CPSD207SU

Con soffione doccia 20x20cm
With shower head 20x20cm

A2063CPSD257SU

Con soffione doccia 25x25cm
With shower head 25x25cm

A2063CPSD307SU

Con soffione doccia 30x30cm
With shower head 30x30cm

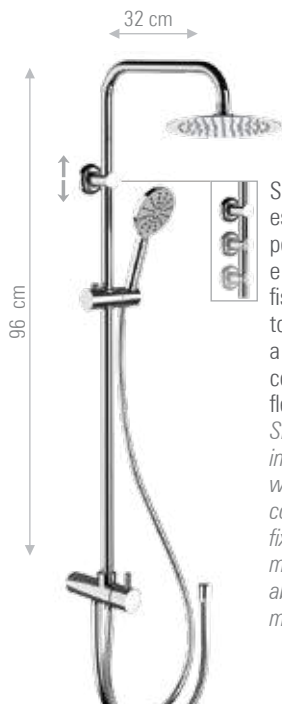

Set colonna doccia con presa acqua esterna, composto da: supporto a muro per colonna con deviatore integrato e presa acqua inferiore, colonna con fissaggio superiore regolabile, soffione tondo ultra piatto in acciaio INOX lucidato a specchio, doccetta in ABS a 4 funzioni con pulsante per il cambio dell'intensità, flessibile 150cm.

Shower column set with external water intake, including: wall support for column with integrated diverter and lower water connection, column with adjustable upper fixing, ultra-flat round shower head in mirror polished stainless steel, 4-function abs hand shower with button for jets mode switching, flexible 150cm.

A2023MP78207SU

Con soffione doccia Ø20cm
With shower head Ø20cm

CR 15

A2023MP78257SU

Con soffione doccia Ø25cm
With shower head Ø25cm

CR 15

A2023MP78307SU

Con soffione doccia Ø30cm
With shower head Ø30cm

CR 15



Set colonna doccia con presa acqua esterna, composto da: supporto a muro per colonna con deviatore integrato e presa acqua inferiore, colonna con fissaggio superiore regolabile, soffione ultra piatto in acciaio INOX lucidato a specchio, doccetta in ABS a 3 funzioni con pulsante per il cambio dell'intensità, flessibile 150cm.

Shower column set with external water intake, including: wall support for column with integrated diverter and lower water connection, column with adjustable upper fixing, ultra-flat squared shower head in mirror polished stainless steel, 3-function abs hand shower with button for jets mode switching, flexible 150cm.

A2023CP79207SU

Con soffione doccia 20x20cm
With shower head 20x20cm

CR 15

A2023CP79257SU

Con soffione doccia 25x25cm
With shower head 25x25cm

CR 15

A2023CP79307SU

Con soffione doccia 30x30cm
With shower head 30x30cm

CR 15

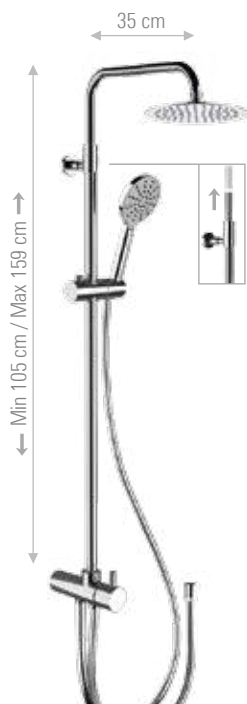

Set colonna doccia con presa acqua esterna, composto da: supporto a muro per colonna con deviatore integrato e presa acqua inferiore, colonna telescopica ad altezza regolabile, soffione tondo ultra piatto in acciaio INOX lucidato a specchio, doccetta in ABS a 4 funzioni con pulsante per il cambio dell'intensità, flessibile 150cm.

Shower column set with external water intake, including: wall support for column with integrated diverter and lower water connection, height-adjustable telescopic column, ultra-flat round shower head in mirror polished stainless steel, 4-function abs hand shower with button for jets mode switching, flexible 150cm.

A2063MP78207SU

Con soffione doccia Ø20cm
With shower head Ø20cm

CR 15

A2063MP78257SU

Con soffione doccia Ø25cm
With shower head Ø25cm

CR 15

A2063MP78307SU

Con soffione doccia Ø30cm
With shower head Ø30cm

CR 15



Set colonna doccia con presa acqua esterna, composto da: supporto a muro per colonna con deviatore integrato e presa acqua inferiore, colonna telescopica ad altezza regolabile, soffione quadrato ultra piatto in acciaio INOX lucidato a specchio, doccetta in ABS a 3 funzioni con pulsante per il cambio dell'intensità, flessibile 150cm.

Shower column set with external water intake, including: wall support for column with integrated diverter and lower water connection, height-adjustable telescopic column, ultra-flat squared shower head in mirror polished stainless steel, 3-function abs hand shower with button for jets mode switching, flexible 150cm.

A2063CP79207SU

Con soffione doccia 20x20cm
With shower head 20x20cm

CR 15

A2063CP79257SU

Con soffione doccia 25x25cm
With shower head 25x25cm

CR 15

A2063CP79307SU

Con soffione doccia 30x30cm
With shower head 30x30cm

CR 15

BOX INCASSO
BUILT-IN BOX

WELLNESS
KIT

CROMOTERAPIA
COLOUR THERAPY

SOFFIONI & SOFFIONI A SOFFITTO
SHOWER HEADS & CEILING

BOCCHE
SPOUTS

PANNELLI
PANELS

COLONNE
COLUMN

SALISCENDI
SLIDING RAILS

DOCCETTE
HAND SHOWERS

OASIS
SHUT-OFF

OUTDOOR

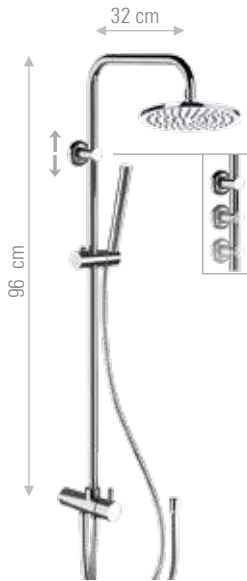

Set colonna doccia con presa acqua esterna, composto da: supporto a muro per colonna con deviatore integrato e presa acqua inferiore, colonna con fissaggio superiore regolabile, soffione in ottone, doccetta in ottone a 1 funzione, flessibile di collegamento 50cm, flessibile 150cm.

Shower column set for external water intake, including: wall fixing for column with water connection and diverter, column with adjustable upper fixing, brass shower head, 1-function brass hand shower, connection hose 50cm, 150cm flexible hose.

A2024355947SU

Con soffione doccia Ø20cm
With shower head Ø20cm

CR FIN A FIN B

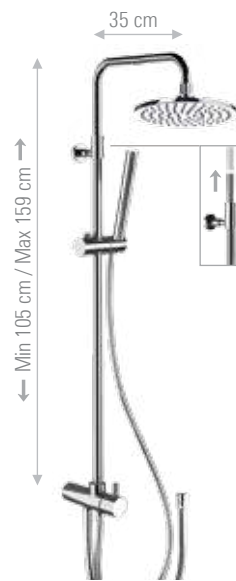

Set colonna doccia, composto da: miscelatore esterno per colonna, colonna con fissaggio superiore regolabile e deviatore, flessibile 150cm, soffione in ottone, doccetta quadrata in ottone a 1 funzione.

Shower column set, including: exposed mixer for column, column with adjustable upper fixing and diverter, 150cm flexible hose, brass shower head, 1-function squared brass hand shower.

A2064355947SU

Con soffione doccia Ø20cm
With shower head Ø20cm

CR FIN A FIN B

A20243594307SU

Con soffione doccia Ø30cm
With shower head Ø30cm

CR FIN A FIN B

A20643594307SU

Con soffione doccia Ø30cm
With shower head Ø30cm

CR FIN A FIN B



Set colonna doccia, composto da: supporto a muro per colonna con deviatore integrato e presa acqua inferiore, colonna con fissaggio superiore regolabile, soffione in ottone, doccetta quadrata in ottone a 1 funzione, flessibile di collegamento 50cm, flessibile 150cm.

Shower column set, including: wall fixing for column with water connection and diverter, column with adjustable upper fixing, brass shower head, 1-function squared brass hand shower, connection hose 50cm, 150cm flexible hose.

A2024955907SU

Con soffione doccia 20x20cm
With shower head 20x20cm

CR FIN A FIN B

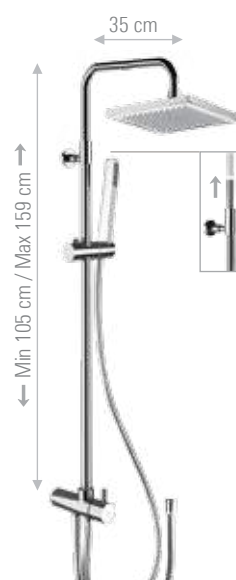

Set colonna doccia con presa acqua esterna, composto da: supporto a muro per colonna con deviatore integrato e presa acqua inferiore, colonna telescopica ad altezza regolabile, soffione 20x20cm in ottone, doccetta quadrata in ottone a 1 funzione, flessibile di collegamento 50cm, flessibile 150cm.

Shower column set for external water intake, including: wall fixing for column with water connection and diverter, height-adjustable telescopic column, brass shower head, 1-function squared brass hand shower, connection hose 50cm, 150cm flexible hose.

A2064955907SU

Con soffione doccia Ø20cm
With shower head Ø20cm

CR FIN A FIN B

A20249593B7SU

Con soffione doccia 30x30cm
With shower head 30x30cm

CR FIN A FIN B

A20649593B7SU

Con soffione doccia Ø30cm
With shower head Ø30cm

CR FIN A FIN B



Tubo in ottone cromato per estensione dell'Altezza delle colonne A200, A205, A250 e A255, Ø 22 mm.

C.p. brass pipe for the extension of height of columns art A200, A205, A250 and A255, for pipe Ø 22 mm.

A205PROL10

10 cm



A205PROL20

20 cm

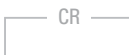

A205PROL40

40 cm

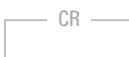

A201PROL20

Tubo in ottone cromato per estensione dell'Altezza delle colonne A201 e A251, lunghezza cm 20, Ø 25 mm.

C.p. brass pipe for the extension of height of columns art A201 and A251, length 20 cm for pipe Ø 25 mm.

CR



A203PROL20

Prolunga per miscelatore da soffitto, per art. A203, A204, A253, A254 lunghezza 20 cm, Ø35 mm, in ottone cromato.

Extension for ceiling mixer length 20 cm, Ø35 mm, in chrome plated brass for art. A203, A204, A253, A254.

CR



A240PROL10

Tubo in ottone cromato per estensione dell'Altezza della colonna art. A230 e A240, lunghezza cm 10 cm.

C.p. brass pipe for the extension of height of columns art A230 and A240, length 10 cm.

CR



A240PROL20

Tubo in ottone cromato per estensione dell'Altezza della colonna art. A230 e A240, lunghezza cm 20 cm.

C.p. brass pipe for the extension of height of columns art A230 and A240, length 20 cm.

CR



A205FL

Flessibile doccia per collegamento colonna doccia-miscelatore, attacco 1/2F x 1/2F, lunghezza 50 cm.

Flexible shower hose for connection shower column-mixer, connection 1/2F x 1/2F, length cm 50.

CR



A300SUP

Presa d'acqua - supporto a muro "minimal" per colonne doccia, multifunzione.

Punch for water outlet and wall bearing "minimal" for shower columns, multifunction.

CR



A305SUP

Presa d'acqua - supporto a muro "quadrato" per colonne doccia, multifunzione.

Punch for water outlet and wall bearing "squared" for shower columns, multifunction.

CR



A303SUP

Supporto inferiore per colonna da 3/4 con passaggio acqua esterno tramite collegamento 1/2.

Lower holder for column 3/4 with external water connector 1/2.

CR



A307SUP

Supporto per colonna da 3/4 con deviatore integrato e presa acqua inferiore 1/2.

Support for 3/4 shower column with integrated diverter and lower water punch connector 1/2.

CR



A205DEV

Deviatore con molla e fermo, per colonne 3/4M x 3/4F x 1/2M.

Diverter with spring and stop, for columns, 3/4M x 3/4F x 1/2M.

CR



A240DEV

Deviatore squadrato per colonne doccia, con molla e fermo 3/4M x 3/4F x 1/2M.

Squared diverter for shower columns, with spring and stop, 3/4M x 3/4F x 1/2M.

CR

BOX INCASSO
BUILT-IN BOX

WELLNESS
KIT

CROMOTERAPIA
COLOUR THERAPY

SOFFIONI & SOFFIONI A SOFFITTO
SHOWER HEADS & CEILING

BOCCHE
SPOUTS

PANNELLI
PANELS

COLONNE
COLUMN

SALISCENDI
SLIDING RAILS

DOCCETTE
HAND SHOWERS

OASIS
SHUT-OFF

OUTDOOR

SALISCENDI SLIDING RAILS

Aste saliscendi per doccia, sia con che senza doccetta in abbinamento, disponibili in diverse forme e materiali per assecondare ogni preferenza estetica e funzionale.

Shower sliding rails, both with and without hand shower, available in different shapes and materials to satisfy every aesthetic and functional preference.



**SALISCENDI
SLIDINGRAILS**

A335435

SALISCENDI CON DOCCETTA - SLIDING RAILS WITH HAND SHOWER



A345495

Saliscendi completamente in ottone cromato quadro con doccetta ad 1 funzione.
C.p. brass square sliding rail set with 1 function handshower.

CR FIN A FIN B



A355495

Saliscendi rettangolare ultraflat con doccetta quadrata ad 1 funzione, tutto in ottone cromato.
Ultraflat rectangular sliding rail and 1 function squared handshower, all in c.p. brass.

CR



A352452

Kit saliscendi con doccetta ad 1 funzione.
Sliding rail set with 1 function handshower.

CR FIN A FIN B



Saliscendi completamente in ottone cromato con supporto regolabile doccetta cilindrica in ottone cromato.
Sliding rail set all in C.P. brass adjustable support with handshower completely in brass.

A340435

Lunghezza 60 cm
Length 60cm

CR FIN A FIN B



Saliscendi Revival, con asta tonda Ø 25 mm e doccetta completamente in ottone cromato.
Revival sliding rail, round rod Ø 25 mm with handshower completely in CP brass.

A308404

Lunghezza 60 cm
Length 60cm

CR FIN A FIN B

A394435

Lunghezza 90 cm
Length 90cm

CR FIN A FIN B

A398404

Lunghezza 90 cm
Length 90cm

CR FIN A FIN B



A3413MP15

Set saliscendi in nero opaco composto da asta saliscendi in metallo/abs con fissaggio superiore regolabile, doccetta in abs nero a 4 funzioni con pulsante per il cambio dei getti, flessibile 150cm.

Matt black metal/abs sliding rail set including sliding rail with adjustable upper fixing, black abs 4-function hand-shower with button for jets mode switching, 150cm flexible hose.

15



A3413CP15

Set saliscendi in nero opaco composto da asta saliscendi in metallo/abs con fissaggio superiore regolabile, doccetta in abs nero a 3 funzioni con pulsante per il cambio dei getti, flessibile 150cm.

Matt black sliding rail set including metal/abs sliding rail with adjustable upper fixing, black abs 3-function hand-shower with button for jets mode switching, 150cm flexible hose.

15



A34143115

Set saliscendi in nero opaco composto da asta saliscendi in metallo/abs con fissaggio superiore regolabile, doccetta in abs nero a 1 funzione, flessibile 150cm.

Matt black sliding rail set including metal/abs sliding rail with adjustable upper fixing, black abs 1-function hand-shower, 150cm flexible hose.

15



A355494

Saliscendi lusso ultra piatto con asta rettangolare piatta con doccetta ad 1 funzione ultrapiatta tutto in ottone.

Deluxe sliding rail Twin extra flat completely in c.p. brass, rectangular extra flat rod, with 1 function hand shower extra flat all in c.p. brass.

CR



A335434

Saliscendi cromato con asta tonda in ABS cromato e doccetta anticalcare a 4 funzioni con getto idromassaggio, getti in silicone.

C.p. ABS sliding rail set with round rod and anti-limestone with silicon jets, hydromassage 4 functions handshower

CR



A335431

Saliscendi cromato con asta tonda in ABS cromato e doccetta in ABS anticalcare.

C.p. ABS sliding rail set with round rod and ABS anti-limestone handshower.

CR



A388477

Saliscendi cromato con asta minimale ovale dritta, doccetta cromata a 4 funzioni, pulsante per cambio getti, anticalcare e flessibile conico in ottone cromato cm 150.

C.p. sliding rail set with c.p. handshower 4 functions, with button to change the jets, anti-limestone and conical shower flexible in c.p. brass cm 150.

CR

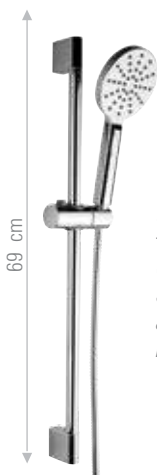

A3013MP

Set saliscendi composto da asta saliscendi, doccetta in abs a 4 funzioni con pulsante per il cambio dei getti, flessibile 150cm.

Sliding rail set including sliding rail, abs 4-function hand-shower with button for jets mode switching, 150cm flexible hose.

CR



A3013CP

Set saliscendi composto da asta saliscendi, doccetta in abs a 3 funzioni con pulsante per il cambio dei getti, flessibile 150cm.

Sliding rail set including sliding rail, abs 3-function hand-shower with button for jets mode switching, 150cm flexible hose.

CR

BOX INCASSO
BUILT-IN BOX

WELLNESS
KIT

CROMOTERAPIA
COLOUR THERAPY

SOFFIONI & SOFFIONI A SOFFITTO
SHOWER HEADS & CEILING

BOCCHE
SPOUTS

PANNELLI
PANELS

COLONNE
COLUMN

SALISCENDI
SLIDING RAILS

DOCCETTE
HAND SHOWERS

OASIS
SHUT-OFF

OUTDOOR



60 cm

A3003F4

Saliscendi con doccetta cromata a 5 funzioni con getti in silicone, anticalcare.
Sliding rail set with c.p. handshower 5 functions, anti-limestone with silicon jets.

CR

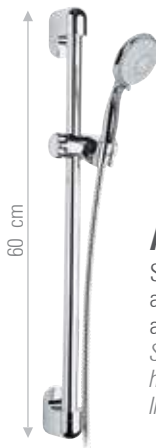

60 cm

A3003F5

Saliscendi con doccetta cromata a 5 funzioni con getti in silicone, anticalcare.
Sliding rail set with c.p. handshower 5 functions, anti-limestone with silicon jets.

CR



66 cm

A350400

Saliscendi cromato con asta tonda e doccetta cromata ad 1 funzione con getti anticalcare in silicone.
C.p. sliding rail set with round rod and c.p. handshower 1 function with anti-limestone silicone jets.

CR



66 cm

A350477

Saliscendi cromato con asta tonda e doccetta cromata a 4 funzioni con pulsante per il cambio dei getti, con getti in silicone anticalcare.
C.p. sliding rail set with round rod and handshower 4 functions with button to change the jets, anti-limestone with silicon jets.

CR

PORTASAPONE - SOAP HOLDER



A350PC25

Portasapone cromato economico per saliscendi con asta Ø 18 o Ø 25.
C.P. soap-holder for sliding rail for round rod Ø 18 or Ø 25.

CR



A300P

Portasapone per saliscendi con asta Ø 24 o Ø 25.
Soap-holder for sliding rail with rod Ø 24 or Ø 25

CR



A300PM

Portasapone cromato per saliscendi con asta Ø 18.
C.P. soap-holder for sliding rail with rod Ø 18.

CR

SALISCENDI - SLIDING RAILS

70 cm

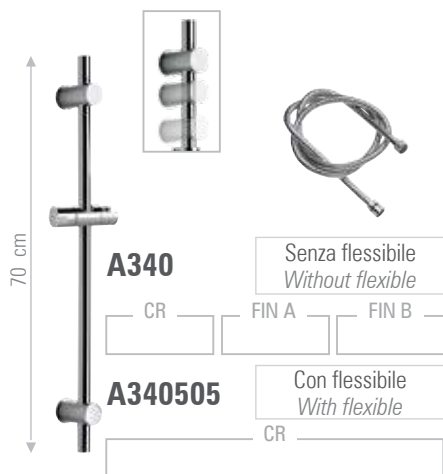

A340 Senza flessibile
Without flexible

CR FIN A FIN B

A340505 Con flessibile
With flexible

CR

87 cm

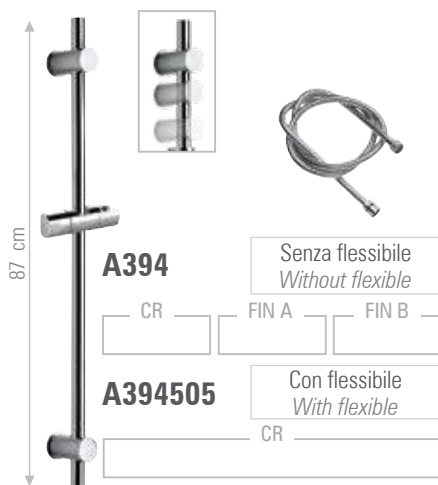

A394 Senza flessibile
Without flexible

CR FIN A FIN B

A394505 Con flessibile
With flexible

CR

70 cm

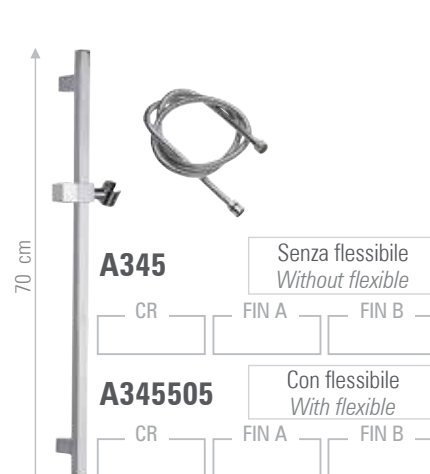

A345 Senza flessibile
Without flexible

CR FIN A FIN B

A345505 Con flessibile
With flexible

CR FIN A FIN B

70 cm

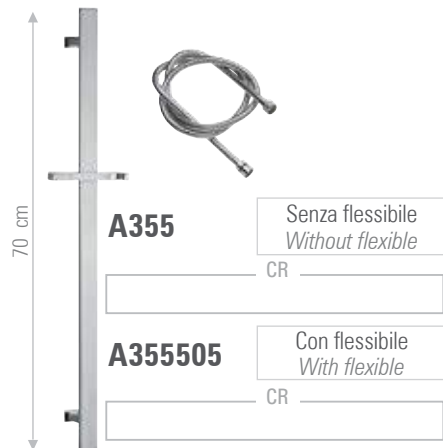

A355 Senza flessibile
Without flexible

CR

A355505 Con flessibile
With flexible

CR

69 cm

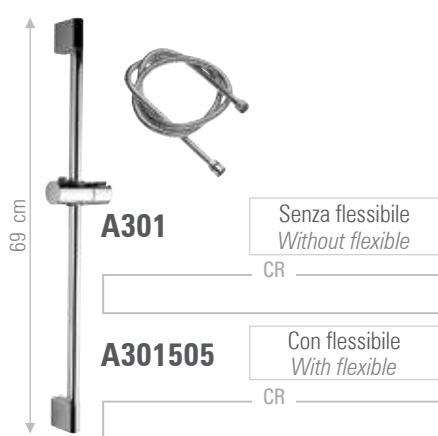

A301 Senza flessibile
Without flexible

CR

A301505 Con flessibile
With flexible

CR

69 cm

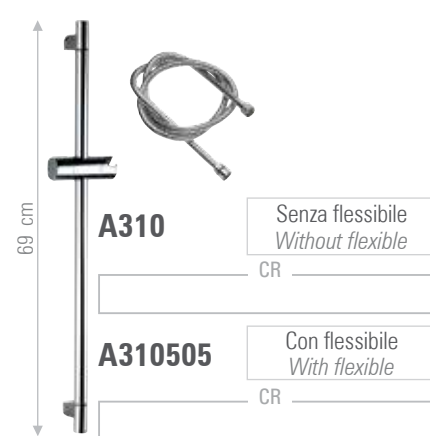

A310 Senza flessibile
Without flexible

CR

A310505 Con flessibile
With flexible

CR

66 cm

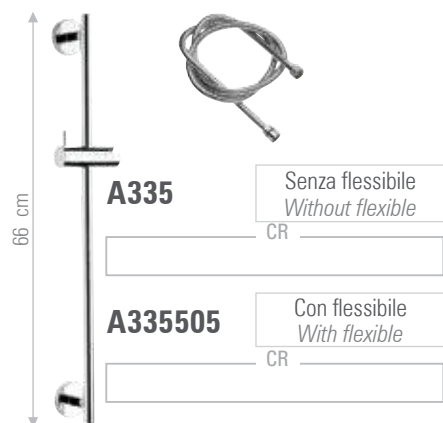

A335 Senza flessibile
Without flexible

CR

A335505 Con flessibile
With flexible

CR

66 cm

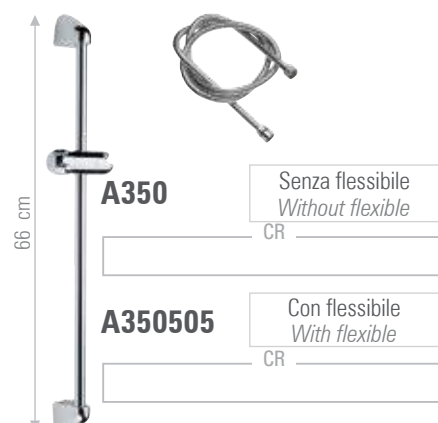

A350 Senza flessibile
Without flexible

CR

A350505 Con flessibile
With flexible

CR

BOX INCASSO
BUILT-IN BOX

WELLNESS
KIT

CROMOTERAPIA
COLOUR THERAPY

SOFFIONI & SOFFIONI A SOFFITTO
SHOWER HEADS & CEILING

BOCCHE
SPOUTS

PANNELLI
PANELS

COLONNE
COLUMN

**SALISCENDI
SLIDING RAILS**

DOCCETTE
HAND SHOWERS

OASIS
SHUT-OFF

OUTDOOR

DOCCETTE HAND SHOWERS

Tante modelli di doccette e supporti, disponibili in diverse forme e materiali per assecondare ogni preferenza estetica e funzionale.

Many models of hand showers and shower holders, available in different shapes and materials to satisfy every aesthetic and functional preference.



DOCCETTE
HAND SHOWERS

A443CP - A443MP

DOCETTE CON SUPPORTO - HAND SHOWERS WITH SHOWER HOLDER

VARIANTI FLESSIBILI - FLEXIBLE OPTIONS

Per richiedere la variante flessibile aggiungere la lettera al codice articolo.

To request a different flexible, add the letter to the article number.

M



A516150

Flessibile doccia retinato realizzato in PVC atossico con attacco conico.
Flexible hose for shower with net working metal colour in atoxic PVC with one conical nut.

CR

C



A506150

Flessibile doccia in PVC atossico con piattina cromata, attacco conico.
Flexible hose for shower in atoxic PVC and chrome flat wire, with one conical nut.

CR



A546435

Set doccia Minimale composto da: presa acqua con supporto lusso in ottone cromato, doccetta in ottone cromato e flessibile 150 cm.
Minimal shower set including: c.p. water punch and shower holder in brass, c.p. brass handshower and 150 cm flexible hose.

CR FIN A FIN B



A547Q495

Set doccia quadrato composto da: presa acqua con supporto lusso in ottone cromato, doccetta in ottone cromato e flessibile 150 cm.
Squared shower set including: c.p. water punch and shower holder in brass, c.p. brass handshower and 150 cm flexible hose.

20 cm

CR FIN A FIN B



A546431

Set doccia minimale composto da: presa acqua con supporto lusso in ottone cromato, doccetta minimale anticalcare in ABS cromato con getti in silicone, cromata ad 1 funzione e flessibile 150 cm.
Minimal shower set including: c.p. water punch and shower holder in brass, c.p. ABS minimal hand shower anti-limestone with jets in silicone, 1 function. and 150 cm flexible hose.

20,5 cm

CR 15



A547Q491

Set doccia quadrato composto da: presa acqua con supporto lusso in ottone, doccetta anticalcare in ABS, e flessibile 150 cm.
Shower set including: water punch and shower holder in brass, antilimestone ABS handshower and 150 cm flexible hose.

20,5 cm

CR 15



A5463MP

Set doccia composto da: presa acqua con supporto lusso in ottone cromato, doccetta cromata a 4 funzioni, con pulsante per cambio dei getti, anticalcare con getti in silicone e flessibile 150 cm.
Shower set including: c.p. water punch and shower holder in brass, handshower 4 functions with button to change the jets, anti-limestone with silicon jets and 150 cm flexible hose.

25 cm

CR 15



A547Q3CP

Set doccia quadrato composto da: presa acqua con supporto lusso in ottone cromato, doccetta cromata a 4 funzioni, con pulsante per cambio dei getti, anticalcare con getti in silicone e flessibile 150 cm.
Squared shower set including: c.p. water punch and shower holder in brass, handshower 4 functions with button to change the jets, anti-limestone with silicon jets and 150 cm flexible hose.

24 cm

CR 15

DOCCE TTE - HAND SHOWERS

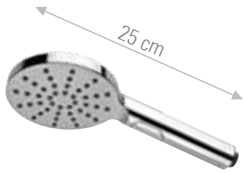

Doccetta cromata a 4 funzioni, pulsante per il cambio dei getti, getti in silicone con anticalcare.

C.p. ABS 4 functions handshower, with button to change jets, anti-limestone with silicon jets.

Senza scatola
Without box

Con scatola
With box

A443MP

A443MPS

CR

CR

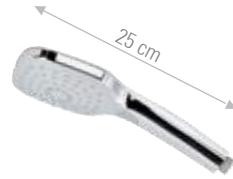

Doccetta in ABS a 3 funzioni con pulsante per il cambio dell'intensità del getto, con getti anticalcare in silicone.

ABS handshower 3 functions with button to change the intensity of the jet, anti-limestone with silicone jets.

Senza scatola
Without box

Con scatola
With box

A443CP

A443CPS

CR

CR



Doccia minimale anticalcare in ABS cromato con getti in silicone, cromata ad 1 funzione.

C.P. ABS minimal hand shower anti-limestone with jets in silicone, 1 function.

Senza scatola
Without box

Con scatola
With box

A431

A431S

CR

CR

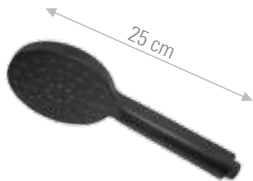

Doccetta cromata a 4 funzioni, pulsante per il cambio dei getti, getti in silicone con anticalcare. Nero opaco.

C.p. ABS 4 functions handshower, with button to change jets, anti-limestone with silicon jets. Matt black.

Senza scatola
Without box

Con scatola
With box

A443MP15

A443MPS15

15

15

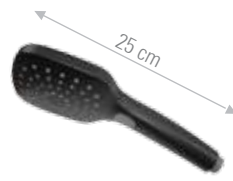

Doccetta in ABS a 3 funzioni con pulsante per il cambio dell'intensità del getto, con getti anticalcare in silicone. Nero opaco.

ABS handshower 3 functions with button to change the intensity of the jet, anti-limestone with silicone jets. Matt black.

Senza scatola
Without box

Con scatola
With box

A443CP15

A443CPS15

15

15



Doccia minimale anticalcare in ABS cromato con getti in silicone, cromata ad 1 funzione. Nero opaco.

C.P. ABS minimal hand shower anti-limestone with jets in silicone, 1 function. Matt black.

Senza scatola
Without box

Con scatola
With box

A43115

A431S15

15

15

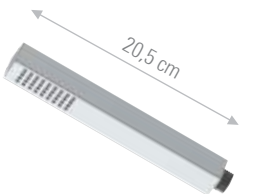

Doccetta quadrata anticalcare in ABS cromato con getti in silicone, ad 1 funzione.

C.p. ABS squared handshower, anti-limestone with jets in silicone, 1 function.

Senza scatola
Without box

Con scatola
With box

A491

A491S

CR

CR

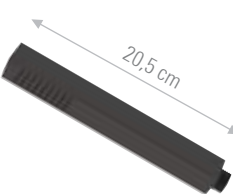

Doccetta quadrata anticalcare in ABS cromato con getti in silicone, ad 1 funzione. Nero opaco.

C.p. ABS squared handshower, anti-limestone with jets in silicone, 1 function. Matt black.

Senza scatola
Without box

Con scatola
With box

A49115

A491S15

15

15



Doccia minimale completamente in ottone cromato ad una funzione.

Minimal hand shower, completely in C.P. brass, one function.

Senza scatola
Without box

Con scatola
With box

A435

A435S

CR

CR

FIN A

FIN A

FIN B

FIN B

BOX INCASSO
BUILT-IN BOX

WELLNESS
KIT

CROMOTERAPIA
COLOUR THERAPY

SOFFIONI & SOFFIONI A SOFFITTO
SHOWER HEADS & CEILING

BOCCHE
SPOUTS

PANNELLI
PANELS

COLONNE
COLUMN

SALISCENDI
SLIDING RAILS

DOCCE TTE
HAND SHOWERS

OASIS
SHUT-OFF

OUTDOOR

WELLNESS

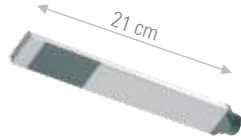

Doccetta rettangolare minimale serie Twin ultrapiatta, in ottone cromato ad 1 funzione.
Extraflat minimal rectangular hand shower Twin, in chrome plated brass, 1 function.

Senza scatola Without box	Con scatola With box
A494	A494S
CR	CR

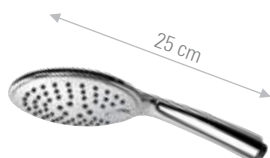

Doccetta cromata a 4 funzioni, pulsante per il cambio dei getti, getti in silicone con anticalcare.
C.p. ABS 4 functions handshower, with button to change jets, anti-limestone with silicon jets.

Senza scatola Without box	Con scatola With box
A477	A477S
CR	CR

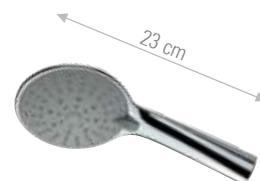

Doccetta cromata a 4 funzioni, getti in silicone con anti-calcare.
C.p. ABS 4 functions handshower, anti-limestone with silicon jets.

Senza scatola Without box	Con scatola With box
A448F5	A448F5S
CR	CR



Doccetta serie Diva ad una funzione in ottone cromato.
Diva hand shower, one function, in chrome plated brass.

Senza scatola Without box	Con scatola With box
A452	A452S
CR	CR
FIN A	FIN A
FIN B	FIN B



Doccetta "Revival" in ottone cromato ad 1 funzione.
C.p. brass "Revival" handshower, 1 function.

Senza scatola Without box	Con scatola With box
A404	A404S
CR	CR
FIN A	FIN A
FIN B	FIN B

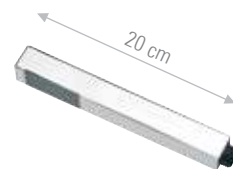

Doccetta quadrata, completamente in ottone ad una funzione in ottone cromato.
Square hand shower completely in CP brass, one function.

Senza scatola Without box	Con scatola With box
A495	A495S
CR	CR
FIN A	FIN A
FIN B	FIN B



Doccetta cromata a 5 funzioni con getti in silicone, anticalcare.
C.p. hand shower 5 functions, anti-limestone with silicone jets.

Senza scatola Without box	Con scatola With box
A443F4	A443F4S
CR	CR



Doccetta cromata a 5 funzioni con getti in silicone, anticalcare.
C.p. hand shower 5 functions, anti-limestone with silicone jets.

Senza scatola Without box	Con scatola With box
A443F5	A443F5S
CR	CR



Doccetta a disco con getto a cascata, 2 funzioni anticalcare.
Anti-limestone disc hand shower with cascade jet, 2 functions.

Senza scatola Without box	Con scatola With box
A444	A444S
CR	CR

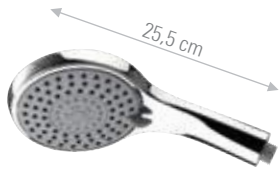

Doccetta a disco 4 funzioni idromassaggio anticalcare.
Anti-limestone hydromassage hand shower 4 functions.

Senza scatola
Without box

A448

CR

Con scatola
With box

A448S

CR

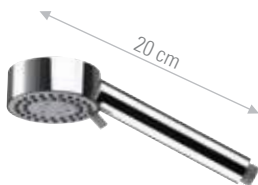

Doccia minimale anticalcare con 4 funzioni, getti in silicone, cromata.
C.P. minimal hand shower anti-limestone with 4 functions in silicone jets.

Senza scatola
Without box

A434

CR

Con scatola
With box

A434S

CR



Doccetta quadrata in ABS cromato ad 1 funzione con getti anticalcare.
Squared hand shower in c.p. ABS, 1 function, with silicon jets.

Senza scatola
Without box

A492

CR

Con scatola
With box

A492S

CR



Doccia idromassaggio anticalcare 4 funzioni cromata.
C.P. hand shower 4 functions, hydromassage, anti-limestone.

Senza scatola
Without box

A460

CR

Con scatola
With box

A460S

CR



Doccia cromata con getti in silicone anticalcare, 1 funzione.
C.P. hand shower anti-limestone with jets in silicone, 1 function.

Senza scatola
Without box

A400

CR

Con scatola
With box

A400S

CR

BOX INCASSO
BUILT-IN BOX

WELLNESS
KIT

CROMOTERAPIA
COLOUR THERAPY

SOFFIONI & SOFFIONI A SOFFITTO
SHOWER HEADS & CEILING

BOCCHE
SPOUTS

PANNELLI
PANELS

COLONNE
COLUMN

SALISCENDI
SLIDING RAILS

DOCCETTE
HAND SHOWERS

OASIS
SHUT-OFF

OUTDOOR

— SUPPORTI DOCCIA CON PRESA ACQUA —
 WATER PUNCH WITH SHOWER HOLDER

**A546T**

Pres a acqua a muro con supporto per doccia e mensola 60x180mm. Altezza 50mm. Acciaio INOX lucidato a specchio.
Wall water connection with hand shower holder and 60x180mm shelf. Height 50mm. Mirror polished stainless steel.

CR

**A546**

Supporto lusso con presa acqua minimale in ottone cromato per incasso, per flessibile con attacco conico.
Minimal c.p. brass shower holder water punch, for built-in and for conical nut flexible.

CR

FIN A

FIN B

**A547**

Pres a acqua a muro quadrata con supporto snodato per doccia, in ottone cromato, per flessibile con attacco conico.
Wall mounting squared water punch with adjustable hand shower holder, c.p. brass, conical nut flexible connection.

CR

FIN A

FIN B

**A547Q**

Pres a acqua a muro quadrata con supporto doccia, in ottone cromato, per flessibile con attacco conico.
Wall mounting squared water punch with hand shower holder, c.p. brass, conical nut flexible connection.

CR

FIN A

FIN B

**A546BY**

Pres a acqua a muro con piastra a muro BROOKLYN con supporto doccia, in ottone, per flessibile con attacco conico.
Wall water connection with BROOKLYN wall flange with handshower holder, in brass, for flexible with conical connection.

CR

FIN A

FIN B

**A547W**

Pres a acqua a muro quadrata con supporto doccia, in ottone cromato, per flessibile con attacco conico.
Wall mounting squared water punch with hand shower holder, c.p. brass, conical nut flexible connection.

CR

FIN A

FIN B

**A544**

Supporto snodato per doccia in ottone cromato con presa acqua.
CP brass adjustable shower holder with water punch connector.

CR

FIN A

FIN B



Ø90mm

A546XB

Pres a acqua a muro con piastra tonda a muro ultra sottile, diametro 90mm, e supporto per doccetta, in ottone, per flessibile con attacco conico.

Wall water connection with ultra-slim round wall plate, diameter 90mm, and hand shower holder, in brass, for flexible hose with conical connection.

CR FIN A FIN B



90x90mm

A546RXB

Pres a acqua a muro con piastra quadrata a muro ultra sottile, 90x90mm, e supporto per doccetta, in ottone, per flessibile con attacco conico.

Wall water connection with ultra-slim squared wall plate, 90x90mm, and hand shower holder, in brass, for flexible hose with conical connection.

CR FIN A FIN B



90x90mm

A547TAB

Pres a acqua a muro con piastra quadrata a muro ultra sottile, 90x90mm, e supporto squadrato per doccetta, in ottone, per flessibile con attacco conico.

Wall water connection with ultra-slim squared wall plate, 90x90mm, and squared hand shower holder, in brass, for flexible hose with conical connection.

CR FIN A FIN B

RUBINETTI DI ARRESTO - ANGLE VALVES



A548

Rubinetto d'arresto minimale tondo, con supporto doccia in ottone cromato e presa acqua, per flessibile con attacco conico.

C.p. brass round minimalist angle valve with shower holder and water punch, for conical nut flexibles.

CR



A549

Rubinetto d'arresto squadrato, con supporto doccia in ottone cromato e presa acqua, per flessibile con attacco conico.

C.p. brass squared angle valve with shower holder and water punch, for conical nut flexibles.

CR



A542

Rubinetto d'arresto minimal con supporto doccia in ottone cromato, per flessibile con attacco conico.

Minimalist angle valve with c.p. brass shower holder, for conical nut flexible hose.

CR



A543

Rubinetto d'arresto serie quadrato con supporto doccia in ottone cromato, per flessibile con attacco conico.

Square angle valve with brass handshower holder, for flexible hose with conical connection.

CR

BOX INCASSO
BUILT-IN BOX

WELLNESS
KIT

CROMOTERAPIA
COLOUR THERAPY

SOFFIONI & SOFFIONI A SOFFITTO
SHOWER HEADS & CEILING

BOCCHE
SPOUTS

PANNELLI
PANELS

COLONNE
COLUMN

SALISCENDI
SLIDING RAILS

DOCCETTE
HAND SHOWERS

OASIS
SHUT-OFF

OUTDOOR

— SUPPORTI DOCCIA - SHOWER HOLDER —



A536

Supporto fisso quadrato in ottone cromato per flessibile con attacco conico.
Shower holder square in CP brass, for conical nut flexible.

CR FIN A FIN B



A537

Supporto fisso in ottone cromato per flessibile con attacco conico.
Shower holder in CP brass, for conical nut flexible.

CR FIN A FIN B



A5350T

Supporto fisso in ottone cromato per flessibile con attacco conico.
Shower holder in CP brass, for conical nut flexible.

CR FIN A FIN B



A530

Supporto snodato per doccetta in ottone cromato.
CP brass adjustable shower holder.

CR FIN A FIN B



A532

Supporto snodato a braccio minimalista in ABS cromato per flessibile con attacco conico.
Adjustable minimal shower holder in CP ABS, for conical nut flexible.

CR



A534

Supporto snodato a braccio quadrato in ABS cromato per flessibile con attacco conico.
Adjustable squared shower holder in CP ABS, for conical nut flexible.

CR



A5353P

Supporto fisso a 3 posizioni in ABS cromato per flessibile con attacco conico.
Shower holder in CP ABS, 3 positions for conical nut flexible.

CR



A540

Supporto fisso in in ABS cromato.
C.P. plastic adjustable shower holder.

CR



A535

Supporto fisso in ABS cromato per flessibile con attacco conico.
Shower holder in CP ABS, for conical nut flexible.

CR

PRESE ACQUA - WATER PUNCH



A520T

Presa acqua a muro con mensola 60x180mm. Altezza 50mm. Acciaio INOX lucidato a specchio.

Wall water connection with 60x180mm shelf. Height 50mm. Mirror polished stainless steel.

CR



A525

Attacco presa acqua da 1/2 tipo rotondo pesante.

C.P. brass wall connector, round heavy type 1/2 for shower.

CR

FIN A

FIN B



A521

Attacco presa acqua da 1/2, tipo quadrato, pesante.

C.p. brass wall water punch connector, squared and heavy type, 1/2, for shower.

CR

FIN A

FIN B



A520

Angolo 1/2Mx1/2M in ottone cromato con rosetta scorrevole.

C.P. brass angle 1/2Mx1/2M with C.P. brass sliding flange.

CR

BOX INCASSO
BUILT-IN BOX

WELLNESS
KIT

CROMOTERAPIA
COLOUR THERAPY

SOFFIONI & SOFFIONI A SOFFITTO
SHOWER HEADS & CEILING

BOCCHE
SPOUTS

PANNELLI
PANELS

COLONNE
COLUMN

SALISCENDI
SLIDING RAILS

DOCCE
HAND SHOWERS

OASIS
SHUT-OFF

OUTDOOR

FLESSIBILI DOCCIA - SHOWER FLEXIBLE HOSES



Flessibile per doccia retinato metallizzato in PVC atossico, con attacco conico.
Flexible hose for shower with net working metal colour, in atoxic PVC, with one conical nut.

A516120 120 cm



A516150 150 cm



A516200 200 cm

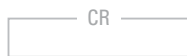

Flessibile per doccia in plastica grigio metallizzato, con attacco conico.
Flexible hose for shower in metallized PVC with conical nut.

A515120 120 cm



A515150 150 cm



A515200 200 cm

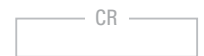

Flessibile doccia in PVC atossico con piattina cromata, attacco conico.
Flexible hose for shower in atoxic PVC and chrome flat wire, with one conical nut.

A506120 120 cm



A506150 150 cm



A506200 200 cm

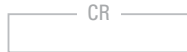

Flessibile per doccia in ottone cromato Ø 14 F.F., con attacco conico, tubo in EPDM.
Shower flexible hose in C.P. brass, EPDM rubber inside, Ø 14, with one conical nut.

A505120 120 cm



A505150 150 cm



A505200 200 cm

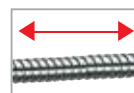

Extendible



Flessibile per doccia estensibile a doppia graffatura in ottone cromato Ø 14 F.F., tubo in EPDM.
Shower flexible hose in CP Brass with double nut connection, EPDM rubber inside.

A500100 100 cm



A500120 120 cm



A500150 150 cm

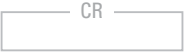

A500200 200 cm



A510120 120 cm



A510150 150 cm

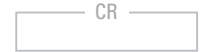

A510200 200 cm



Flessibile per doccia estensibile a doppia graffatura in ottone cromato Ø 14 F.F., tubo in EPDM, con attacco conico.
Flexible and extendible hose for shower, double clinching in C.P. brass, Ø 14, EPDM rubber internal, with one conical nut.

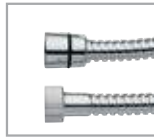

Flessibile per doccia in acciaio INOX Ø 14, tubo interno in gomma EPDM, attacco conico, 1/2".
Shower flexible hose in stainless steel Ø 14, internal in EPDM rubber, one conical nut, 1/2".

A505X120	120 cm	<input type="checkbox"/> CR <input type="checkbox"/>
A505X150	150 cm	<input type="checkbox"/> CR <input type="checkbox"/>
A505X200	200 cm	<input type="checkbox"/> CR <input type="checkbox"/>



Flessibile per doccia estensibile a doppia graffatura in acciaio INOX Ø 14 F.F., tubo in EPDM, con attacco conico.
Flexible and extensible hose for shower, double clinching in stainless steel, Ø 14 F.F., EPDM rubber internal, with one conical nut.

A510X100	100 cm	<input type="checkbox"/> CR <input type="checkbox"/>
A510X120	120 cm	<input type="checkbox"/> CR <input type="checkbox"/>
A510X150	150 cm	<input type="checkbox"/> CR <input type="checkbox"/>
A510X175	175 cm	<input type="checkbox"/> CR <input type="checkbox"/>



Flessibile per doccia estensibile a doppia graffatura in ottone, con sistema girevole ed anti-torsione, Ø 15 mm, tubo in EPDM con attacco conico.
Flexible and extensible hose for shower, in C.P. brass, Anti-torsion swivelling system, Ø 15 mm, EPDM rubber inside with one conical nut.

A505120AT	120 cm	<input type="checkbox"/> CR <input type="checkbox"/>
A505150AT	150 cm	<input type="checkbox"/> CR <input type="checkbox"/>
A505200AT	200 cm	<input type="checkbox"/> CR <input type="checkbox"/>

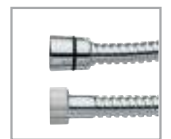

Flessibile per doccia a doppia graffatura in ottone cromato Ø 17 F.F., tubo in EPDM, con attacco conico.
Flexible hose for shower, double clinching in C.P. brass, 17 mm Ø F.F., EPDM rubber inside, with one conical nut.

A511150	150 cm	<input type="checkbox"/> CR <input type="checkbox"/>
A511200	200 cm	<input type="checkbox"/> CR <input type="checkbox"/>

BOX INCASSO
 BUILT-IN BOX

WELLNESS
 KIT

CROMOTERAPIA
 COLOUR THERAPY

SOFFIONI & SOFFIONI A SOFFITTO
 SHOWER HEADS & CEILING

BOCCHE
 SPOUTS

PANNELLI
 PANELS

COLONNE
 COLUMN

SALISCENDI
 SLIDING RAILS

DOCCE
 HAND SHOWERS

OASIS
 SHUT-OFF

OUTDOOR

FLESSIBILI DOCCIA IN FINITURA
SHOWER FLEXIBLE HOSES WITH FINISHING

FIN A



Flessibile per doccia retinato metallizzato in pvc atossico, con attacco doppio brillante conico, nero opaco.

Flexible hose for shower with net working metal colour, in atoxic pvc, with double conical shiny brilliant nut, matt black.

A51712015 120 cm

A51715015 150 cm



Flessibile per doccia retinato metallizzato in pvc atossico, con attacco doppio brillante conico, bianco opaco.

Flexible hose for shower with net working metal colour, in atoxic pvc, with double conical shiny brilliant nut, matt white.

A51712014 120 cm

A51715014 150 cm



Flessibile per doccia retinato metallizzato in pvc atossico, con attacco doppio brillante conico, nichel spazzolato.

Flexible hose for shower with net working metal colour, in atoxic pvc, with double conical shiny brilliant nut, brushed nickel.

A517120NP 120 cm

A517150NP 150 cm



Flessibile per doccia retinato metallizzato in pvc atossico, con attacco doppio brillante conico, visual inox.

Flexible hose for shower with net working metal colour, in atoxic pvc, with double conical shiny brilliant nut, visual steel.

A517120XV 120 cm

A517150XV 150 cm



Flessibile per doccia retinato metallizzato in pvc atossico, con attacco doppio brillante conico, vecchio ottone.

Flexible hose for shower with net working metal colour, in atoxic pvc, with double conical shiny brilliant nut, old brass.

A51712063 120 cm

A51715063 150 cm



Flessibile per doccia retinato metallizzato in pvc atossico, con attacco doppio brillante conico, vecchio rame.

Flexible hose for shower with net working metal colour, in atoxic pvc, with double conical shiny brilliant nut, old copper.

A51712064 120 cm

A51715064 150 cm



Flessibile per doccia retinato metallizzato in pvc atossico, con attacco doppio brillante conico, vecchio ottone opaco.

Flexible hose for shower with net working metal colour, in atoxic pvc, with double conical shiny brilliant nut, matt old brass.

A5171200M 120 cm

A5171500M 150 cm



Flessibile per doccia retinato metallizzato in pvc atossico, con attacco doppio brillante conico, ottone S.Marco.

Flexible hose for shower with net working metal colour, in atoxic pvc, with double conical shiny brilliant nut, S.Marco brass.

A517120SM 120 cm

A517150SM 150 cm



Flessibile per doccia retinato metallizzato in pvc atossico, con attacco doppio brillante conico, oil bronze.

Flexible hose for shower with net working metal colour, in atoxic pvc, with double conical shiny brilliant nut, oil bronze.

A517120OIL 120 cm

A517150OIL 150 cm

FIN B



Flessibile per doccia retinato metallizzato in pvc atossico, con attacco doppio brillante conico, oro lucido.

Flexible hose for shower with net working metal colour, in atoxic pvc, with double conical shiny brilliant nut, shiny gold.

A517120DO 120 cm

A517150DO 150 cm



Flessibile per doccia retinato metallizzato in pvc atossico, con attacco doppio brillante conico, oro spazzolato.

Flexible hose for shower with net working metal colour, in atoxic pvc, with double conical shiny brilliant nut, brushed gold.

A517120DP 120 cm

A517150DP 150 cm



Flessibile per doccia retinato metallizzato in pvc atossico, con attacco doppio brillante conico, rame spazzolato lucido.

Flexible hose for shower with net working metal colour, in atoxic pvc, with double conical shiny brilliant nut, shiny brushed copper.

A517120RP 120 cm

A517150RP 150 cm



Flessibile per doccia retinato metallizzato in pvc atossico, con attacco doppio brillante conico, cromo nero lucido.

Flexible hose for shower with net working metal colour, in atoxic pvc, with double conical shiny brilliant nut, shiny black chrome.

A517120CF 120 cm

A517150CF 150 cm



Flessibile per doccia retinato metallizzato in pvc atossico, con attacco doppio brillante conico, cromo nero spazzolato lucido.

Flexible hose for shower with net working metal colour, in atoxic pvc, with double conical shiny brilliant nut, shiny brushed black chrome.

A517120FZ 120 cm

A517150FZ 150 cm

BOX INCASSO
BUILT-IN BOX

WELLNESS
KIT

CROMOTERAPIA
COLOUR THERAPY

SOFFIONI & SOFFIONI A SOFFITTO
SHOWER HEADS & CEILING

BOCCHE
SPOUTS

PANNELLI
PANELS

COLONNE
COLUMN

SALISCENDI
SLIDING RAILS

DOCCETTE
HAND SHOWERS

OASIS
SHUT-OFF

OUTDOOR

OASIS SHUT-OFF

OASIS SHUT-OFF è una collezione di miscelatori e doccette a pulsante dedicati all'igiene personale. I modelli realizzati in ottone sono disponibili anche con opzioni di finitura per un perfetto abbinamento con il resto della rubinetteria nella stanza.

OASIS SHUT-OFF is a collection of mixers and shut-off hand-showers dedicated to personal cleaning. Made-in-brass items are also available with finishing options for a perfect match with the other faucets in the room.



OASIS
SHUT-OFF

SK646Z4DCT

MISCELATORE INCASSO PER SHUT-OFF - BUILT-IN SHUT-OFF MIXER



SK646
Miscelatore incasso per shut-off.
Built-in shut-off mixer.

CR FIN A FIN B



OX23646
Miscelatore incasso per shut-off.
Built-in shut-off mixer.

CR FIN A FIN B



DV646
Miscelatore incasso per shut-off.
Built-in shut-off mixer.

CR FIN A FIN B



OM646
Miscelatore incasso per shut-off.
Built-in shut-off mixer.

CR FIN A FIN B



S20646
Miscelatore incasso per shut-off.
Built-in shut-off mixer.

CR FIN A FIN B

SET SHUT-OFF TERMOSTATICO
THERMOSTATIC SHUT-OFF SET



ST206424DC

Miscelatore incasso termostatico per shut-off con doccetta shut-off, supporto doccia, presa acqua.
Thermostatic built-in shut-off mixer set with shut-off, shower holder, water punch.



CR FIN A FIN B

SET SHUT-OFF CON MENSOLA
SHUT-OFF SET WITH SHELF



SK646Z4DCT

Kit per shut-off da incasso, include: miscelatore a incasso, presa acqua a muro con mensola 60x180mm e supporto doccetta, doccetta igienica "shut-off" e flessibile.

Built-in shut-off kit, including: built-in mixer, wall water connection with 60x180mm shelf and hand-shower holder, "shut-off" hand-spray for personal cleaning and flexible hose.

CR

SET MISCELATORI SHUT-OFF A INCASSO
BUILT-IN SHUT-OFF MIXER SET



TK6454DC

Miscelatore incasso per shut-off con supporto doccia e presa acqua, con doccetta shut-off e flessibile 120 cm.
Built-in shut-off mixer set with shower holder and water punch, with shut-off and flexible hose 120 cm.

CR FIN A FIN B

TK645H

Senza kit doccia.
Without shower set.

CR FIN A FIN B



SK645

Set shut-off comprensivo di: miscelatore a incasso su piastra in ottone con supporto e presa acqua integrati, doccetta shut-off art. 1010DC e flessibile doccia cm 120.

Built-in shut-off set including : built-in mixer on brass plate with integrated holder and water connection, shut-off handshower art 1010DC and shower hose 120 cm.

CR FIN A FIN B

SK645H

Senza kit doccia.
Without shower set.

CR FIN A FIN B



OM645

Miscelatore incasso per shut-off serie Omega su piastra in ottone cromato, supporto doccia e presa acqua, comprensivo di doccetta shut-off art. 1000DC, supporto doccia-presa acqua, tutto in ottone cromato e flessibile doccia cm 120.

Omega model built-in shower mixer all in c.p. brass with shower holder and water punch, including shut-off art. 1000DC, shower holder-water punch on flange, all in c.p. brass and shower flexible cm 120.

CR FIN A FIN B

OM645H

Senza kit shut-off.
Without shut-off set.

CR FIN A FIN B



SR645

Miscelatore incasso per shut-off su piastra in ottone cromato, supporto doccia e presa acqua, comprensivo di doccetta shut-off art. 1000DC, supporto doccia-presa acqua, tutto in ottone cromato e flessibile doccia cm 120.

Built-in shower mixer all in c.p. brass with shower holder and water punch, including shut-off art. 1000DC, shower holder-water punch on flange, all in c.p. brass and shower flexible cm 120.

CR FIN A FIN B

SR645H

Senza kit shut-off.
Without shut-off set.

CR FIN A FIN B



TA645

Miscelatore incasso per shut-off con supporto doccia e presa acqua, comprensivo di doccetta shut-off art. 1000DC, supporto doccia-presa acqua, tutto in ottone cromato e flessibile doccia cm 120.

Built-in shower mixer with shower holder and water punch, including: shut-off art. 1000DC, shower holder-water punch on flange, all in c.p. brass and shower flexible cm 120.

CR FIN A FIN B

TA645H

Senza kit shut-off.
Without shut-off set.

CR FIN A FIN B

BOX INCASSO
BUILT-IN BOX

WELLNESS
KIT

CROMOTERAPIA
COLOUR THERAPY

SOFFIONI & SOFFIONI A SOFFITTO
SHOWER HEADS & CEILING

BOCCHE
SPOUTS

PANNELLI
PANELS

COLONNE
COLUMN

SALISCENDI
SLIDING RAILS

DOCCETTE
HAND SHOWERS

OASIS
SHUT-OFF

OUTDOOR



DV642

Miscelatore incasso per shut-off con doccetta shut-off, supporto doccia, presa acqua.
Built-in shut-off mixer set shut-off, shower holder, water punch.

CR	FIN A	FIN B
----	-------	-------



SP642

Miscelatore incasso per shut-off con doccetta shut-off, supporto doccia, presa acqua.
Built-in shut-off mixer set shut-off, shower holder, water punch.

CR	FIN A	FIN B
----	-------	-------



TK6424DC

Miscelatore incasso per shut-off con doccetta shut-off, supporto doccia e presa acqua.
Built-in shut-off mixer set with shut-off, shower holder and water punch.

CR	FIN A	FIN B
----	-------	-------



FU6424DC

Miscelatore incasso per shut-off con doccetta shut-off, supporto doccia e presa acqua.
Built-in shut-off mixer set, with shut-off, shower holder and water punch.

CR	FIN A	FIN B
----	-------	-------



OM642

Miscelatore incasso per shut-off con doccetta shut-off, supporto doccia, presa acqua.
Built-in shut-off mixer set shut-off, shower holder, water punch.

CR	FIN A	FIN B
----	-------	-------



SK642

Miscelatore incasso per shut-off con doccetta shut-off, supporto doccia, presa acqua.
Built-in shut-off mixer set with shut-off, shower holder, water punch.

CR	FIN A	FIN B
----	-------	-------

SHUT-OFF GREEN - GREEN SHUT-OFF



SRE645LT8



Miscelatore incasso per shut-off con doccetta shut-off, supporto doccia, presa acqua.
Built-in shut-off mixer set shut-off, shower holder, water punch.

CR	FIN A	FIN B
----	-------	-------



OME645LT8



Miscelatore incasso per shut-off con doccetta shut-off, supporto doccia, presa acqua.
Built-in shut-off mixer set shut-off, shower holder, water punch.

CR	FIN A	FIN B
----	-------	-------

SET MISCELATORI SHUT-OFF ESTERNI
EXPOSED SHUT-OFF MIXER SET



MT22631ADP

Set composto da: doccia a pulsante, flessibile conico 120 cm, miscelatore doccia e gancio in ABS cromato.

Set including: shut-off handshower, flexible hose 120 cm, shower mixer and c.p. ABS hook.

CR FIN A FIN B



1031

Set "Oasis", composto da: doccia a pulsante, flessibile conico 120 cm, miscelatore doccia e supporto in ottone cromato.

"Oasis" set including: shut-off handshower, flexible 120 cm, shower mixer and c.p. brass shower holder.

CR



1031Z

Set "Oasis", composto da: doccia a pulsante in ottone cromato con impugnatura zigrinata, flessibile conico 120 cm, miscelatore doccia e supporto in ottone cromato.

"Oasis" set including: c.p. brass shut-off handshower with knurled handgrip, flexible 120 cm, shower mixer and c.p. brass shower holder.

CR



OM22611ADP

Miscelatore monocomando esterno doccia, interasse 100 mm, comprensivo di doccetta shut-off in ABS cromato flessibile conico in ottone cromato 120 cm e gancio in ABS cromato.

Wall mounted single lever shower mixer, interaxis 100 mm, including: shut-off handshower, conical flexible in c.p. brass cm 120 and c.p. ABS hook.

CR FIN A FIN B



SR22611ADP

Miscelatore monocomando esterno doccia, interasse 100 mm, comprensivo di doccia a pulsante, flessibile conico in ottone cromato 120 cm e gancio in ABS cromato.

Wall mounted single lever shower mixer, interaxis 100 mm, including: shut-off handshower, conical flexible in c.p. brass cm 120, and c.p. ABS hook.

CR FIN A FIN B

OM22611

Senza kit doccia.
Without shower set.

CR FIN A FIN B

SR22611

Senza kit doccia.
Without shower set.

CR FIN A FIN B



OM605SH4DC

Miscelatore monocomando lavabo con doccia shut-off e scarico click-clack con troppo pieno.
Single-lever basin mixer with shut-off handshower and click-clack pop-up waste with overflow.

CR FIN A FIN B



SR605SH4DC

Miscelatore monocomando lavabo con doccia shut-off e scarico click-clack con troppo pieno.
Single-lever basin mixer with shut-off handshower and click-clack pop-up waste with overflow.

CR FIN A FIN B

BOX INCASSO
BUILT-IN BOX

WELLNESS
KIT

CROMOTERAPIA
COLOUR THERAPY

SOFFIONI & SOFFIONI A SOFFITTO
SHOWER HEADS & CEILING

BOCCHE
SPOUTS

PANNELLI
PANELS

COLONNE
COLUMN

SALISCENDI
SLIDING RAILS

DOCCETTE
HAND SHOWERS

OASIS
SHUT-OFF

OUTDOOR

SET SHUT-OFF MONOACQUA - SINGLE WATER SHUT-OFF SET



1035
KIT per shut-off comprensivo di rubinetto di arresto arrotondato con supporto doccia, flessibile 120 cm, doccetta in ottone cromato.
Shut-off KIT including rounded angle valve with shower holder, flexible hose 120 cm, c.p. brass shut-off handshower.

CR FIN A FIN B



1039
KIT per SHUT-OFF comprensivo di rubinetto di arresto arrotondato con supporto doccia, flessibile 120 cm, doccetta in ottone cromato.
SHUT-OFF KIT including rounded angle valve with shower holder, flexible hose 120 cm, c.p. brass shut-off handshower.

CR FIN A FIN B



1045
KIT per SHUT-OFF comprensivo di rubinetto di arresto squadrato con supporto doccia, flessibile 120 cm, doccetta in ottone cromato.
SHUT-OFF KIT including squared angle valve with shower holder, flexible hose 120 cm, c.p. brass shut-off handshower.

CR FIN A FIN B



1015
Set composto da: doccia a pulsante in ottone cromato, flessibile con attacco conico cm 120 rubinetto d'arresto con supporto doccia in ottone cromato.
Set including: c.p. brass shut-off handshower, flexible cm 120, c.p. brass round angle valve with shower holder.

CR



1025
Set composto da: doccia a pulsante quadrata in ottone cromato, flessibile con attacco conico cm 120 rubinetto d'arresto con supporto doccia in ottone cromato.
Set including: squared c.p. brass shut-off handshower, flexible cm 120, c.p. brass squared angle valve with shower holder.

CR



1015Z
Set composto da: doccia a pulsante in ottone cromato con impugnatura zigrinata, flessibile con attacco conico cm 120 rubinetto d'arresto con supporto doccia in ottone cromato.
Set including: c.p. brass shut-off handshower with knurled handgrip, flexible cm 120, c.p. brass round angle valve with shower holder.

CR



1015EU
Set composto da: doccia a pulsante in ABS, flessibile con attacco conico cm 120 rubinetto d'arresto con supporto doccia in ottone cromato.
Set including: c.p. ABS shut-off handshower, flexible cm 120, c.p. brass round angle valve with shower holder.

CR



1027
Set composto da: doccia a pulsante in ottone cromato (con chiave pulizia aeratore), flessibile conico 120 cm, flessibile con attacco conico cm 120 rubinetto d'arresto con supporto doccia in ottone cromato.
Set including: c.p. brass shut-off handshower (with cleaning aerator key), conical flex, flexible cm 120, c.p. brass round angle valve with shower holder.

CR



1019
Set composto da: doccia a pulsante in ottone cromato, flessibile con attacco conico cm 120 rubinetto d'arresto con supporto doccia in ottone cromato.
Set including: c.p. brass shut-off handshower, flexible cm 120, c.p. brass round angle valve with shower holder.

CR



1000

Set "Oasis" composto da: doccia a pulsante art. 1000DC, flex. conico cm 120 rubinetto ad angolo con vitone ceramico e supporto in ottone cromato.

"Oasis" set including: shut-off handshower Art. 1000DC, flex.cm 120, angle valve with ceramic headwork and brass shower holder.

CR _____ FIN A _____ FIN B _____



1010

Set "Oasis" composto da: doccia a pulsante art. 1010DC, flex. conico cm 120 rubinetto ad angolo quadro con vitone ceramico e supporto in ottone cromato.

"Oasis" set including: shut-off handshower Art. 1010DC, flex. cm 120, Square angle valve with ceramic headwork and brass shower holder.

CR _____ FIN A _____ FIN B _____



1004

Set "Oasis" composto da: doccia a pulsante art. 1004DC, flex. conico cm 120 rubinetto ad angolo con vitone ceramico e supporto in ottone cromato.

"Oasis" set including: shut-off handshower Art. 1004DC, flex.cm 120, angle valve with ceramic headwork and brass shower holder.

CR _____ FIN A _____ FIN B _____



1000Z

Set "Oasis" composto da: doccia a pulsante art. 1000DCZ, flex. conico cm 120 rubinetto ad angolo con vitone ceramico e supporto in ottone cromato.

"Oasis" set including: shut-off handshower Art. 1000DCZ, flex.cm 120, angle valve with ceramic headwork and c.p. brass shower holder.

CR _____ FIN A _____ FIN B _____



1012

Set "Oasis", composto da: doccia a pulsante art.1012DC (con chiave pulizia aeratore), flessibile conico 120 cm, rubinetto ad angolo con vitone ceramico e supporto in ottone cromato.

"Oasis" set including: shut-off handshower art.1012DC (with cleaning aerator key), conical flex. hose 120cm, angle valve with ceramic headwork and brass shower holder.

CR _____



1005EUR

Set composto da doccia a pulsante minimale in ABS cromata Art. 1005DC, flessibile conico metallizzato 120 cm, rubinetto ad angolo "Minimal" in ottone cromato e supporto in ottone cromato.

Set including: shut-off handshower minimal in ABS Art. 1005DC, flexible cm 120, angle valve "Minimal" in C.P. brass and c.p. brass shower holder.

CR _____



1001CR

Set composto da doccia a pulsante minimale in ABS cromata Art. 1001DCCR, flessibile conico metallizzato 120 cm, rubinetto ad angolo in ottone cromato e supporto in ottone cromato.

Set including: shut-off handshower minimal in ABS Art. 1001DCCR, flexible cm 120, angle valve in C.P. brass and c.p. brass shower holder.

CR _____



1000TEM

Set "Oasis" composto da: doccia a pulsante art. 1000DC, flex. conico cm 120 rubinetto temporizzato 1/2" in ottone cromato tempo d'apertura 6-8 secondi e supporto in ottone cromato.

"Oasis" set including: shut-off handshower Art. 1000DC, flex.cm 120, temporized button flusher 1/2" all in Cp brass, opening time 6-8 seconds, and c.p. brass shower holder.

CR _____



1011

Set "Oasis" composto da: doccia a pulsante art. 1000DCZ, flex. conico cm 120 rubinetto ad angolo e supporto in ottone cromato.

"Oasis" set including: shut-off handshower Art. 1000DCZ, flex.cm 120, angle valve and c.p. brass shower holder.

CR _____



1001

Set "Sandy Beach" composto da doccia a pulsante bianca 1001DC, flessibile retinato bianco 120 cm, rubinetto ad angolo in ottone cromato e supporto bianco.

"Sandy Beach" set including: shut-off handshower with Art. 1001DC, flex. white cm 120, angle valve in C.P. brass and white shower holder.

CR _____

BOX INCASSO
BUILT-IN BOX

WELLNESS
KIT

CROMOTERAPIA
COLOUR THERAPY

SOFFIONI & SOFFIONI A SOFFITTO
SHOWER HEADS & CEILING

BOCCHE
SPOUTS

PANNELLI
PANELS

COLONNE
COLUMN

SALISCENDI
SLIDING RAILS

DOCCETTE
HAND SHOWERS

OASIS
SHUT-OFF

OUTDOOR

DOCCETTE SHUT-OFF CON SUPPORTO
SHUT-OFF HANDSHOWER WITH HOLDER

**1010SR**

Set "Oasis" composto da: doccia a pulsante art. 1010DC, flex. conico cm 120 e supporto in ottone cromato.

"Oasis" set including: shut-off handshower Art. 1010DC, flex. cm 120, and c.p. brass shower holder.

CR

**1000SR**

Set "Oasis" composto da: doccia a pulsante art. 1000DC, flex. conico cm 120 e supporto in ottone cromato.

"Oasis" set including: shut-off handshower Art. 1000DC, flex.cm 120, and brass shower holder.

CR

**1012SR**

Set "Oasis", composto da: doccia a pulsante art.1012DC (con chiave pulizia aeratore), flessibile conico 120 cm, e supporto in ottone cromato.

"Oasis" set including: shut-off handshower art.1012DC (with cleaning aerator key), conical flex. hose 120cm, and brass shower holder.

CR

**1000ZSR**

Set "Oasis" composto da: doccia a pulsante art. 1000DCZ, flex. conico cm 120 e supporto in ottone cromato.

"Oasis" set including: shut-off handshower Art. 1000DCZ, flex.cm 120, and brass shower holder.

CR

**1004SR**

Set "Oasis" composto da: doccia a pulsante art. 1004DC, flex. conico cm 120 e supporto in ottone cromato.

"Oasis" set including: shut-off handshower Art. 1004DC, flex.cm 120 and c.p. brass shower holder.

CR

**1005EURSR**

Set composto da doccia a pulsante minimale in ABS cromata Art. 1005DC, flessibile conico metallizzato 120 cm e supporto in ottone cromato.

Set including: shut-off handshower minimal in ABS Art. 1005DC, flex. cm 120 and c.p. brass shower holder.

CR

**1001SRCR**

Set "Sandy Beach" composto da doccia a pulsante cromata Art. 1000DPCR, flessibile 120 cm e in ottone cromato.

"Sandy Beach" set including: shut-off handshower with Art. 1000DPCR, flexible hose cm 120 and c.p. brass shower holder.

CR

**1001SR**

Set "Sandy Beach" composto da doccia a pulsante bianca Art. 1001DC, flessibile retinato 120 cm e supporto bianco.

"Sandy Beach" set including: shut-off handshower with Art. 1001DC, flex. cm 120 and white shower holder.

CR

**A520NR**

Raccordo in ottone 1/2"F x 1/2"M con valvola di non ritorno.

Brass fitting, 1/2F x 1/2M, with non-return valve.

CR

DOCCE TTE SHUT-OFF IN OTTONE CROMATO
C.P. BRASS SHUT-OFF HANDSHOWER



1000DCZ

Doccetta a pulsante in ottone cromato, impugnatura zigrinata 1/2".
C.P. brass shut-off handshower with knurled handgrip 1/2".

CR FIN A FIN B



1004DC

Doccetta a pulsante in ottone cromato 1/2".
C.P. brass shut-off handshower 1/2".

CR FIN A FIN B



1010DC

Doccetta a pulsante quadrata in ottone cromato 1/2".
C.P. brass shut-off squared handshower 1/2".

CR FIN A FIN B



1000DC

Doccetta a pulsante in ottone cromato, impugnatura liscia 1/2".
C.P. brass shut-off handshower with plain hand grip 1/2".

CR FIN A FIN B



1000BDC

Doccetta a pulsante "Lux" in ottone cromato, con impugnatura bombata 1/2".
C.P. brass shut-off "Lux" handshower with convex handgrip, 1/2".

CR



1012DC

Doccetta a pulsante in ottone cromato, impugnatura liscia da 1/2" con kit aeratore e chiave.
C.p. brass shut-off handshower, with plain handgrip, 1/2" complete with aerator and key.



CR

DOCCE TTE SHUT-OFF IN ABS - ABS SHUT-OFF HANDSHOWER



1005DC

Doccetta a pulsante minimale in ABS cromata 1/2".
C.P. ABS shut-off minimal in ABS 1/2".

CR



1001DC

Doccetta a pulsante bianca 1/2".
White. ABS shut-off white 1/2".

CR



1001DCCR

Doccetta shut-off cromata in ABS stampata made in italy.
Chrome ABS shut off handshower printed made in italy.

CR



1001DCNE

Doccetta shut-off nera in ABS stampata made in italy.
Black ABS shut off handshower printed made in italy.

CR



1000DPCR

Doccetta a pulsante cromata 1/2".
C.P. ABS shut-off white 1/2".

CR



1000DPBN

Doccetta a pulsante bianca 1/2".
White ABS shut-off white 1/2".

CR

BOX INCASSO
BUILT-IN BOX

WELLNESS
KIT

CROMOTERAPIA
COLOUR THERAPY

SOFFIONI & SOFFIONI A SOFFITTO
SHOWER HEADS & CEILING

BOCCHE
SPOUTS

PANNELLI
PANELS

COLONNE
COLUMN

SALISCENDI
SLIDING RAILS

DOCCE TTE
HAND SHOWERS

OASIS
SHUT-OFF

OUTDOOR

OUTDOOR

Una selezione di colonne doccia autoportanti in acciaio inox spazzolato adatte alle aree esterne.

A selection of free-standing shower columns in brushed stainless steel suitable for outdoor areas.



OUTDOOR

SSA2964358LP



SSA294LP

Colonna doccia da esterno autoportante con miscelatore e deviatore a 2 vie: spray a pioggia con getto anticalcare e getto spray lavapiedi, acciaio INOX lucidato a specchio ,
Freestanding outdoor shower column with mixer and 2-way diverter: rain anti-limestone jet and foot washer spray jet, mirror polished stainless steel.

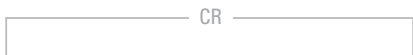

SSA294636

Colonna doccia da esterno autoportante con miscelatore e deviatore a 2 vie: spray a pioggia con getto anticalcare e doccia a L getto spray, acciaio INOX lucidato a specchio ,
Freestanding outdoor shower column with mixer and 2-way diverter: rain anti-limestone jet and L-shaped hand shower spray, mirror polished stainless steel.

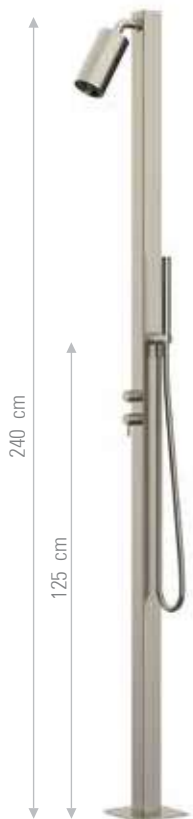
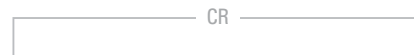

SSA2964358LP

Colonna doccia da esterno autoportante con miscelatore e deviatore a 2 vie: soffione con 3 aeratori a pioggia, doccia a 1 funzione, acciaio INOX spazzolato.
Freestanding outdoor shower column with mixer and 2-way diverter: shower head with 3 rain aerators, 1-function hand shower, brushed stainless steel.

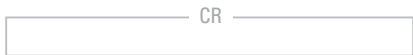

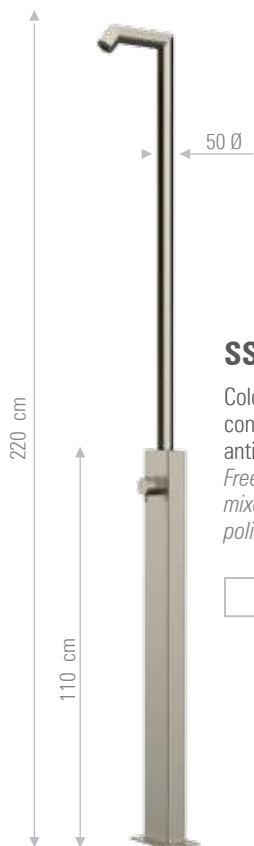

SSA294637

Colonna doccia da esterno autoportante con miscelatore e spray a pioggia con getto anticalcare, acciaio INOX lucidato a specchio ,
Freestanding outdoor shower column with mixer and rain anti-limestone jet, mirror polished stainless steel.



SSA292

Colonna doccia da esterno autoportante con miscelatore monocomando a 2 vie: getto pioggia anti-calcare e getto basso a cascata, Acqua calda-fredda con attacco da pavimento, acciaio INOX spazzolato.
Freestanding outdoor shower column with single lever mixer and 2-way diverter: rain jet with anti-limestone system and low waterfall jet.

Hot/ cold water control, floor mounted. Brushed stainless steel.



BOX INCASSO
 BUILT-IN BOX

WELLNESS
 KIT

CROMOTERAPIA
 COLOUR THERAPY

SOFFIONI & SOFFIONI A SOFFITTO
 SHOWER HEADS & CEILING

BOCCHE
 SPOUTS

PANNELLI
 PANELS

COLONNE
 COLUMN

SALISCENDI
 SLIDING RAILS

DOCCETTE
 HAND SHOWERS

OASIS
 SHUT-OFF

OUTDOOR



THERMOSTATICS



XF600H

X-FACTOR

pag 496

Q-FACTOR

pag 508

X-FACTOR

X-FACTOR è una collezione di miscelatori termostatici dalle forme morbide e tondeggianti per doccia e vasca da bagno.

X-FACTOR is a collection of thermostatic mixers with soft and rounded shapes for shower and bathtub.



XF636U18



XF636DA3MP8420

CARATTERISTICHE TECNICHE:

La serie è dotata di cartuccia termostatica prodotta da S.T.S.R.
Studio Tecnico Sviluppo e Ricerche - www.stsr.it

TECHNICAL FEATURES:

The series is equipped with thermostatic cartridge, produced by S.T.S.R.
Research Development Technical Office - www.stsr.it

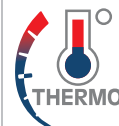

Termostatico. L'utilizzo dei modelli termostatici può aiutare ad avere un maggiore controllo sul consumo di acqua ed energia.

Thermostatic. The use of thermostatic models can help you to have more control over the energy and water consumption.



XF610



XF610

INCASSI DOCCIA - BUILT IN SHOWER MIXER



ST20602

Miscelatore termostatico da incasso per doccia.

Thermostatic built-in mixer for shower.



ST20612

Miscelatore termostatico da incasso con deviatore per vasca-doccia.

Thermostatic built-in single-lever mixer, with diverter for bath-shower.



ST20612D2

Miscelatore termostatico per doccia con deviatore a 2 vie su piastra unica.

Thermostatic shower mixer, with 2 ways diverter on single flange.



ST20612D3

Miscelatore termostatico per doccia con deviatore a 3 vie e 3 posizioni (una entrata e tre uscite) su piastra unica.

Thermostatic built-in shower mixer with 3 ways diverter and 3 positions (1 inlet and 3 outlets) on single flange.



ST20612D4

Miscelatore termostatico per doccia, con deviatore a 4 vie (4 uscite ed 1 entrata) su piastra unica.

Thermostatic shower mixer with 4 ways diverter (4 outlets and 1 inlet) on single flange.



ST20612D5

Miscelatore termostatico per doccia, con deviatore a 5 vie (5 uscite ed una entrata) su piastra unica.

Thermostatic shower mixer with 5 ways diverter (5 outlets and 1 inlet) on single flange.



TXT625

Miscelatore termostatico a incasso e deviatore a incasso (TK625ZDEV) su piastre tonde separate.

Built-in thermostatic shower mixer and built-in diverter (TK625ZDEV) on round flanges. NB: The two built-in parts are independent of each other and allow the individual elements to be positioned freely according to each project needs.



MISCELATORI VASCA E DOCCIA - BATH & SHOWER MIXERS

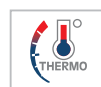

XF610

Miscelatore termostatico esterno vasca, con flessibile cm 150 e doccetta.
Thermostatic bath mixer, with flexible cm 150 and handshower.

CR FIN A FIN B



XF611Z

Miscelatore esterno doccia termostatico, con attacco alto da 1/2" ed attacco inferiore da 1/2".
Thermostatic shower mixer, with upper 1/2" connection and lower 1/2" connection.

CR FIN A FIN B



XF611Z34

Miscelatore esterno doccia termostatico, con attacco alto da 3/4" ed attacco inferiore da 1/2".
Thermostatic shower mixer, with upper 3/4" connection and lower connection 1/2".

CR FIN A FIN B



XF600H

Miscelatore termostatico esterno vasca, senza kit doccia.
Thermostatic bath mixer, without shower kit.

CR FIN A FIN B



XF611

Miscelatore esterno doccia termostatico con attacco inferiore da 1/2".
Thermostatic shower mixer with lower 1/2" connection.

CR FIN A FIN B



XF600DH

Miscelatore termostatico esterno a 3 vie per vasca/doccia con attacco alto da 1/2" ed attacco inferiore da 1/2".
3-way exposed thermostatic bath/shower mixer with 1/2" upper connection and 1/2" lower connection.

CR

SHUT-OFF

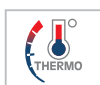

ST206424DC

Miscelatore incasso termostatico per shut-off con doccetta shut-off, supporto doccia, presa acqua.
Thermostatic built-in shut-off mixer set with shut-off, hand shower, shower holder/water punch.

CR FIN A FIN B

XF600DHB

Miscelatore termostatico esterno a 3 vie per vasca/doccia con attacco alto da 1/2" ed attacco inferiore da 1/2", maniglie in ottone cromato.
3-way exposed thermostatic bath/shower mixer with 1/2" upper connection and 1/2" lower connection, handles in chrome plated brass.

CR FIN A FIN B

COLONNE DOCCIA/VASCA TELESCOPICHE
TELESCOPIC BATH/SHOWER COLUMN

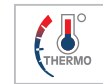

Set colonna a 3 vie termostatico, composto da: miscelatore termostatico vasca/doccia esterno per colonna, colonna telescopica ad altezza regolabile, soffione in abs, doccetta in ABS a 4 funzioni con pulsante per il cambio dell'intensità, flessibile 150cm.
3-way bath/shower column set, including: exposed thermostatic bath/shower mixer for column with diverter, height-adjustable telescopic column, abs shower head, 4-function abs hand shower with button for jets mode switching, 150cm flexible hose.

XF636DA3MP8420

Con soffione doccia Ø 20cm
With shower head Ø 20cm

CR

XF636DA3MP8425

Con soffione doccia Ø 25cm
With shower head Ø 25cm

CR

XF636DA3MP8430

Con soffione doccia Ø 30cm
With shower head Ø 30cm

CR



Set colonna a 3 vie termostatico, composto da: miscelatore termostatico vasca/doccia esterno per colonna, colonna telescopica ad altezza regolabile, soffione ultra piatto in acciaio INOX lucidato a specchio, doccetta in abs a 1 funzione, flessibile 150cm.
3-way bath/shower column set, including: exposed thermostatic bath/shower mixer for column with diverter, height-adjustable telescopic column, ultra-flat Ø20cm shower head in mirror-polished stainless steel, 1-function abs hand shower, 150cm flexible hose.

XF636DA4317820

Con soffione doccia Ø 20cm
With shower head Ø 20cm

CR 15

XF636DA4317825

Con soffione doccia Ø 25cm
With shower head Ø 25cm

CR 15

XF636DA4317830

Con soffione doccia Ø 30cm
With shower head Ø 30cm

CR 15

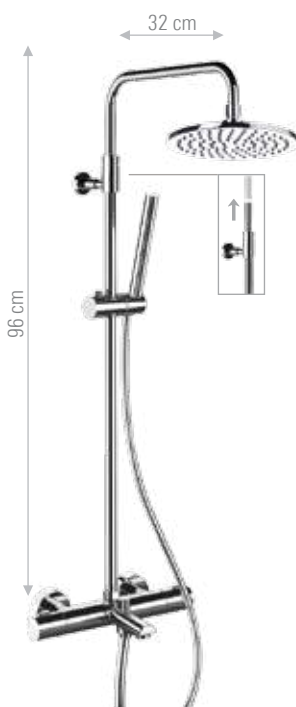

Set colonna a 3 vie termostatico, composto da: miscelatore termostatico vasca/doccia esterno per colonna, colonna telescopica ad altezza regolabile, soffione in ottone, doccetta in ottone a 1 funzione, flessibile 150cm.
3-way bath/shower column set, including: exposed thermostatic bath/shower mixer for column with diverter, height-adjustable telescopic column, brass shower head, 1-function brass hand shower, 150cm flexible hose.

XF636DBA435594

Con soffione doccia Ø 20cm
With shower head Ø 20cm

CR FIN A FIN B

XF636DBA4359430

Con soffione doccia Ø 30cm
With shower head Ø 30cm

CR FIN A FIN B

COLONNE DOCCIA TELESCOPICHE TELESCOPIC SHOWER COLUMN

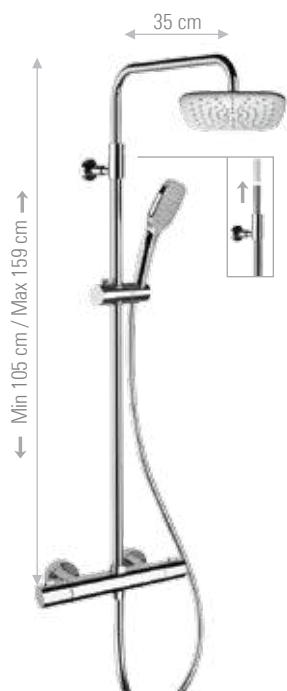
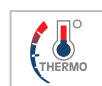

XF636A3CPAD20

Set colonna doccia, composto da: miscelatore termostatico esterno per colonna, colonna telescopica ad altezza regolabile, soffione 20x20cm in abs con angoli arrotondati, doccetta in ABS a 3 funzioni con pulsante per il cambio dell'intensità, flessibile 150cm.
Shower column set, including: exposed thermostatic mixer for column, height-adjustable telescopic column, 20x20cm c.p. abs shower head with rounded corners, 3-function abs hand shower with button for switching jet modes, 150cm flexible hose.

CR



XF636A8420

Set colonna doccia, composto da: miscelatore termostatico esterno per colonna, colonna telescopica ad altezza regolabile, soffione Ø 20cm in abs, doccetta in abs a 3 funzioni, flessibile 150cm.
Shower column set, including: exposed thermostatic mixer for column, height-adjustable telescopic column, Ø 20cm abs shower head, 3-function abs hand shower, 150cm flexible hose.

CR



Set colonna doccia, composto da: miscelatore termostatico esterno per colonna, colonna telescopica ad altezza regolabile, soffione in abs, doccetta cromata a 4 funzioni con pulsante per il cambio dell'intensità, flessibile 150cm.
Shower column set, including: exposed thermostatic mixer for column, height-adjustable telescopic column, abs shower head, 4-function c.p. hand shower with button for switching jet modes, 150cm flexible hose.

XF636A3MP8420

Con soffione doccia Ø20cm
With shower head Ø20cm

CR

XF636A3MP8425

Con soffione doccia Ø25cm
With shower head Ø25cm

CR

XF636A3MP8430

Con soffione doccia Ø30cm
With shower head Ø30cm

CR



Set colonna doccia termostatico, composto da: miscelatore termostatico esterno per colonna, colonna telescopica ad altezza regolabile, soffione ultra piatto in acciaio INOX lucidato a specchio, doccetta in ABS a 4 funzioni con pulsante per il cambio dell'intensità, flessibile 150cm.
Thermostatic shower column set, including: exposed thermostatic mixer for column, height-adjustable telescopic column, ultra-flat shower head in mirror-polished stainless steel, 4-function abs hand shower with button for jets mode switching, 150cm flexible hose.

XF636A3MP7820

Con soffione doccia Ø20cm
With shower head Ø20cm

CR 15

XF636A3MP7825

Con soffione doccia Ø25cm
With shower head Ø25cm

CR 15

XF636A3MP7830

Con soffione doccia Ø30cm
With shower head Ø30cm

CR 15

THERMOSTATICS



Set colonna doccia, composto da: miscelatore termostatico esterno per colonna, colonna telescopica ad altezza regolabile, soffione Ø 20 cm in abs cromato, doccetta in abs a 3 funzioni, flessibile 150cm.
Shower column set, including: exposed thermostatic mixer for column, height-adjustable telescopic column, Ø 20cm abs shower head, 3-function abs hand shower, 150cm flexible hose.

XF636AEC20
 Con soffione doccia Ø 20cm
 With shower head Ø 20cm

CR



Set colonna doccia, composto da: miscelatore termostatico esterno per colonna, colonna telescopica ad altezza regolabile, soffione ultra piatto lucidato a specchio con angoli arrotondati, doccetta in ABS a 3 funzioni con pulsante per il cambio dell'intensità, flessibile 150cm.
Shower column set, including: exposed thermostatic mixer for column, height-adjustable telescopic column, ultra-flat shower head in mirror-polished stainless steel with rounded corners, 3-function abs hand shower with button for switching jet modes, 150cm flexible hose.

XF636A3CP7720
 Con soffione doccia 20x20cm
 With shower head 20x20cm

CR 15

XF636A3CP7725
 Con soffione doccia 25x25cm
 With shower head 25x25cm

CR 15

XF636A3CP7730
 Con soffione doccia 30x30cm
 With shower head 30x30cm

CR 15

COLONNE DOCCIA CON FISSAGGIO REGOLABILE SHOWER COLUMN WITH ADJUSTABLE FIXING

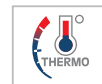

XF636XEC20
 Set colonna doccia, composto da: miscelatore termostatico esterno per colonna, colonna con fissaggio superiore regolabile, soffione Ø 20 cm in abs cromato, doccetta in abs a 3 funzioni, flessibile 150cm.
Shower column set, including: exposed thermostatic mixer for column, column with adjustable upper fixing, Ø 20cm abs shower head, 3-function abs hand shower, 150cm flexible hose.

CR



XF636X3CPAD20
 Set colonna doccia, composto da: miscelatore termostatico esterno per colonna, colonna con fissaggio superiore regolabile, soffione 20x20cm in abs con angoli arrotondati, doccetta in ABS a 3 funzioni con pulsante per il cambio dell'intensità, flessibile 150cm.
Shower column set, including: exposed thermostatic mixer for column, column with adjustable upper fixing, 20x20cm c.p. abs shower head with rounded corners, 3-function abs hand shower with button for switching jet modes, 150cm flexible hose.

CR



XF636X7820

Set colonna doccia, composto da: miscelatore termostatico esterno per colonna, colonna con fissaggio superiore regolabile, soffione ultra piatto in acciaio INOX lucidato a specchio, doccetta in abs a 3 funzioni, flessibile 150cm.
Shower column set, including: exposed thermostatic mixer for column, column with adjustable upper fixing, ultra-flat shower head in mirror-polished stainless steel, 3-function abs hand shower, 150cm flexible hose.



XF636X3MP8420

Set colonna doccia, composto da: miscelatore termostatico esterno per colonna, colonna con fissaggio superiore regolabile, soffione in abs, doccetta in ABS a 4 funzioni con pulsante per il cambio dell'intensità, flessibile 150cm.
Shower column set, including: exposed thermostatic mixer for column, column with adjustable upper fixing, abs shower head, 4-function abs hand shower with button for switching jet modes, 150cm flexible hose.

XF636X7820

Con soffione doccia Ø20cm
 With shower head Ø20cm

CR

XF636X7825

Con soffione doccia Ø25cm
 With shower head Ø25cm

CR

XF636X7830

Con soffione doccia Ø30cm
 With shower head Ø30cm

CR

XF636X3MP8420

Con soffione doccia Ø20cm
 With shower head Ø20cm

CR

XF636X3MP8425

Con soffione doccia Ø25cm
 With shower head Ø25cm

CR

XF636X3MP8430

Con soffione doccia Ø30cm
 With shower head Ø30cm

CR



XF636X8420

Con soffione doccia Ø20cm
 With shower head Ø20cm

CR

XF636X8425

Con soffione doccia Ø25cm
 With shower head Ø25cm

CR

XF636X8430

Con soffione doccia Ø30cm
 With shower head Ø30cm

CR



XF636X3CP7720

Con soffione doccia 20x20cm
 With shower head 20x20cm

CR 15

XF636X3CP7725

Con soffione doccia 25x25cm
 With shower head 25x25cm

CR 15

XF636X3CP7730

Con soffione doccia 30x30cm
 With shower head 30x30cm

CR 15

Set colonna doccia, composto da: miscelatore termostatico esterno per colonna, colonna con fissaggio superiore regolabile, soffione ultra piatto 20x20cm lucidato a specchio con angoli arrotondati, doccetta in ABS a 3 funzioni con pulsante per il cambio dell'intensità, flessibile 150cm.
Shower column set, including: exposed thermostatic mixer for column, column with adjustable upper fixing, ultra-flat 20x20cm shower head in mirror-polished stainless steel with rounded corners, 3-function abs hand shower with button for switching jet modes, 150cm flexible hose.

COLONNE DOCCIA - SHOWER COLUMN

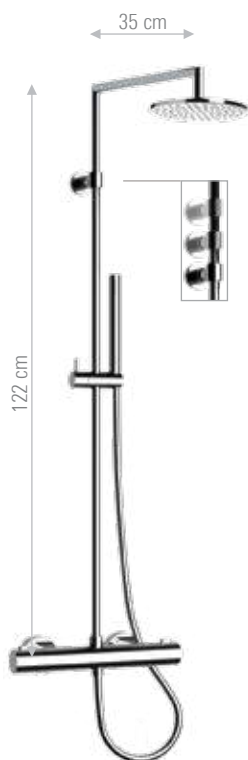
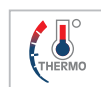

XF636N18

Set colonna doccia termostatica, composto da: miscelatore termostatico esterno per colonna, colonna con fissaggio superiore regolabile, soffione Ø 25cm in abs, doccetta in abs a 1 funzione, flessibile di collegamento 50cm, flessibile 150cm.

Thermostatic shower column set, including: exposed thermostatic mixer for column, column with adjustable upper fixing, Ø 25cm abs shower head, 1-function abs hand shower, connection hose 50cm, 150cm flexible hose.

CR



XF636U18

Set colonna doccia termostatica, composto da: miscelatore termostatico esterno per colonna, colonna con fissaggio superiore regolabile, soffione Ø 20 cm in ottone, doccetta in ottone a 1 funzione, flessibile di collegamento 50cm, flessibile 150cm.

Thermostatic shower column set, including: exposed thermostatic mixer for column, column with adjustable upper fixing, Ø 20cm brass shower head, 1-function brass hand shower, connection hose 50cm, 150cm flexible hose.

CR

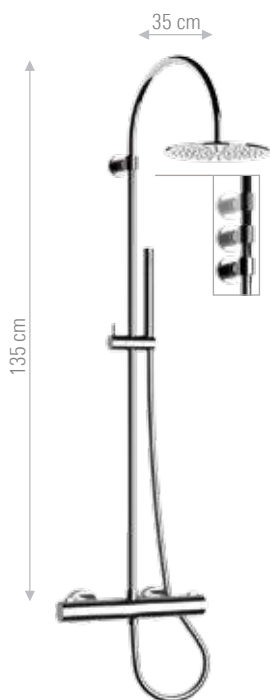

XF636L18

Set colonna doccia termostatica, composto da: miscelatore termostatico esterno per colonna, colonna con fissaggio superiore regolabile, soffione Ø 20 cm in ottone, doccetta in ottone a 1 funzione, flessibile di collegamento 50cm, flessibile 150cm.

Thermostatic shower column set, including: exposed thermostatic mixer for column, column with adjustable upper fixing, Ø 20cm brass shower head, 1-function brass hand shower, connection hose 50cm, 150cm flexible hose.

CR



XF636U

Set colonna doccia, composto da: miscelatore termostatico esterno per colonna, colonna girevole, soffione Ø 20 cm in ottone, doccetta in ottone a 1 funzione, flessibile 150cm.

Shower column set, including: exposed thermostatic mixer for column, swivel column, Ø 20cm brass shower head, 1-function brass hand shower, 150cm flexible hose.

CR

FIN A

FIN B

KIT WELLNESS - WELLNESS KIT

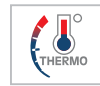

ST20615Z

Set doccia a incasso, composto da: miscelatore termostatico a incasso con deviatore, attacco presa acqua a muro con supporto per doccetta, braccio a muro in ottone 30cm, soffione Ø 20 cm in ottone, doccetta in ottone a 1 funzione, flessibile 150cm.

Built-in shower set, including: built-in thermostatic mixer with diverter, wall water connection with hand shower holder, 30cm brass wall arm, Ø 20cm brass shower head, 1-function brass hand shower, 150cm flexible hose.



ST20614Z

Set doccia a incasso, composto da: miscelatore termostatico a incasso con deviatore, asta saliscendi in ottone, attacco presa acqua a muro, braccio a muro in ottone 30cm, soffione Ø 20 cm in ottone, doccetta in ottone a 1 funzione, flessibile 150cm.

Built-in shower set, including: built-in thermostatic mixer with diverter, brass sliding rail, wall water connection, 30cm brass wall arm, Ø 20cm brass shower head, 1-function brass hand shower, 150cm flexible hose.

CR FIN A FIN B

CR FIN A FIN B

ST20615S

Con braccio a soffitto in ottone 30cm, soffione Ø 20 cm in ottone.
With 30cm brass ceiling arm, Ø 20cm brass shower head.

CR FIN A FIN B

ST20614S

Con braccio a soffitto in ottone 30cm, soffione Ø 20 cm in ottone.
With 30cm brass ceiling arm, Ø 20cm brass shower head.

CR FIN A FIN B



ST20615ZSSCA

Set doccia a incasso, composto da: miscelatore termostatico a incasso con deviatore 3 vie e 7 posizioni, attacco presa acqua a muro con supporto per doccetta, soffione a parete ultra-sottile in acciaio inox lucidato a specchio con getto pioggia e cascata, doccetta in ottone a 1 funzione, flessibile 150cm.

Built-in shower set, including: Thermostatic built-in mixer with 3-way 7-posizion diverter, wall water connection with hand shower holder, ultra-flat wall-mounted shower head in mirror-polished stainless steel with rain and waterfall jets, 1-function brass hand shower, 150cm flexible hose.



ST20614ZSSCA

Set doccia a incasso, composto da: miscelatore termostatico a incasso con deviatore 3 vie e 7 posizioni, asta saliscendi in ottone, attacco presa acqua a muro, soffione a parete ultra-sottile in acciaio inox lucidato a specchio con getto pioggia e cascata, doccetta in ottone a 1 funzione, flessibile 150cm.

Built-in shower set, including: Thermostatic built-in mixer with 3-way 7-posizion diverter, brass sliding rail, wall water connection, ultra-flat wall-mounted shower head in mirror-polished stainless steel with rain and waterfall jets, 1-function brass hand shower, 150cm flexible hose.

CR

CR

ST20615ZSS

Con soffione a parete ultra-sottile in acciaio inox lucidato a specchio, doccetta in ottone a 1 funzione.
With ultra-flat wall-mounted shower head in mirror-polished stainless steel, 1-function brass hand shower.

CR

ST20614ZSS

Con soffione a parete ultra-sottile in acciaio inox lucidato a specchio.
With ultra-flat wall-mounted shower head in mirror-polished stainless steel.

CR

Q-FACTOR

Q-FACTOR è una collezione di miscelatori termostatici esterni e da incasso dalle forme moderne e squadrate, un comfort di design dedicato all'ambiente doccia.

Q-FACTOR is a collection of exposed and built-in thermostatic mixers with modern and squared shapes, a design comfort dedicated to shower interior.





SKT614ZSSCA

CARATTERISTICHE TECNICHE:

La serie è dotata di cartuccia termostatica prodotta da S.T.S.R.
Studio Tecnico Sviluppo e Ricerche - www.stsr.it

TECHNICAL FEATURES:

The series is equipped with thermostatic cartridge, produced by S.T.S.R.
Research Development Technical Office - www.stsr.it

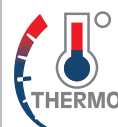

Termostatico. L'utilizzo dei modelli termostatici può aiutare ad avere un maggiore controllo sul consumo di acqua ed energia.

Thermostatic. The use of thermostatic models can help you to have more control over the energy and water consumption.



SKT615ZSSCA



INCASSI DOCCIA - BUILT IN SHOWER MIXER



SKT602

Miscelatore termostatico da incasso per doccia.

Thermostatic built-in mixer for shower.



SKT612

Miscelatore termostatico da incasso con deviatore per vasca-doccia.

Thermostatic built-in single-lever mixer, with diverter for bath-shower.



SKT612D2

Miscelatore termostatico per doccia con deviatore a 2 vie su piastra unica.

Thermostatic shower mixer, with 2 ways diverter on single flange.



SKT612D3

Miscelatore termostatico per doccia con deviatore a 3 vie e 3 posizioni (una entrata e tre uscite) su piastra unica.

Thermostatic built-in shower mixer with 3 ways diverter and 3 positions (1 inlet and 3 outlets) on single flange.



SKT612D4

Miscelatore termostatico per doccia, con deviatore a 4 vie (4 uscite ed 1 entrata) su piastra unica.

Thermostatic shower mixer with 4 ways diverter (4 outlets and 1 inlet) on single flange.



SKT612D5

Miscelatore termostatico per doccia, con deviatore a 5 vie (5 uscite ed una entrata) su piastra unica.

Thermostatic shower mixer with 5 ways diverter (5 outlets and 1 inlet) on single flange.



MISCELATORI DOCCIA - SHOWER MIXERS

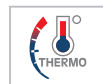

ZT611Z

Miscelatore esterno doccia termostatico, forma quadrata, con deviatore incorporato ed attacco alto da 3/4" ed attacco inferiore da 1/2", maniglie in ABS cromato.
Thermostatic shower mixer, squared shape, with integrated diverter, upper 3/4" connection and lower 1/2" connection, handles in chrome plated ABS.

CR



ZT611ZB

Miscelatore esterno doccia termostatico, forma quadrata, con deviatore incorporato ed attacco alto da 3/4" ed attacco inferiore da 1/2", maniglie in ottone cromato.
Thermostatic shower mixer, squared shape, with integrated diverter, upper 3/4" connection and lower 1/2" connection, handles in chrome plated brass.

CR FIN A FIN B

COLONNE DOCCIA - SHOWER COLUMN

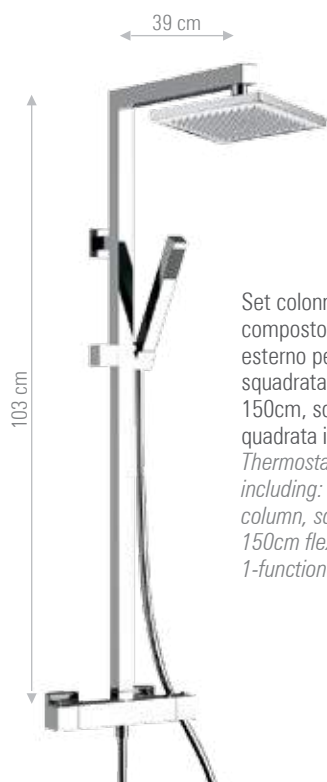
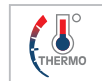

Set colonna doccia termostatica, composto da: miscelatore termostatico esterno per colonna, colonna doccia squadrata con deviatore, flessibile doccia 150cm, soffione in ottone, doccetta quadrata in ottone a 1 funzione.
Thermostatic shower column set, including: exposed thermostatic mixer for column, squared column with diverter and 150cm flexible hose, brass shower head, 1-function squared brass hand shower.

ZT636B495590

Con soffione 20x20 cm in ottone.
 With 20x20cm brass shower head.

CR FIN A FIN B



Set colonna doccia, composto da: miscelatore termostatico esterno per colonna, colonna doccia squadrata con deviatore, flessibile doccia 150cm, soffione ultra piatto 20x20cm in acciaio INOX lucidato a specchio, doccetta squadrata in abs a 1 funzione.
Shower column set, including: exposed thermostatic mixer for column, squared column with diverter and 150cm flexible hose, ultra-flat 20x20cm shower head in mirror-polished stainless steel, 1-function abs squared hand shower.

ZT636B

Con soffione 20x20 cm in ottone.
 With 20x20cm brass shower head.

CR

ZT636B49593B

Con soffione 30x30 cm in ottone.
 With 30x30cm brass shower head.

CR FIN A FIN B

THERMOSTATICS



Set colonna doccia termostatico, composto da: miscelatore termostatico esterno per colonna, colonna con fissaggio superiore regolabile, soffione in abs, doccetta in ABS a 3 funzioni con pulsante per il cambio dell'intensità, flessibile 150cm.

Thermostatic shower column set, including: exposed thermostatic mixer for column, column with adjustable upper fixing, abs shower head, 3-function abs hand shower with button for jets mode switching, 150cm flexible hose.

ZT636X3CPSD20

Con soffione doccia 20x20cm
With shower head 20x20cm

ZT636X3CPSD25

Con soffione doccia 25x25cm
With shower head 25x25cm

ZT636X3CPSD30

Con soffione doccia 30x30cm
With shower head 30x30cm



Set colonna doccia termostatico, composto da: miscelatore termostatico esterno per colonna, colonna con fissaggio superiore regolabile, soffione ultra piatto in acciaio INOX lucidato a specchio, doccetta in ABS a 3 funzioni con pulsante per il cambio dell'intensità, flessibile 150cm.

Thermostatic shower column set, including: exposed thermostatic mixer for column, column with adjustable upper fixing, ultra-flat shower head in mirror-polished stainless steel, 3-function abs hand shower with button for jets mode switching, 150cm flexible hose.

ZT636X3CP7920

Con soffione doccia 20x20cm
With shower head 20x20cm

ZT636X3CP7925

Con soffione doccia 25x25cm
With shower head 25x25cm

ZT636X3CP7930

Con soffione doccia 30x30cm
With shower head 30x30cm



Set colonna doccia termostatico, composto da: miscelatore termostatico esterno per colonna, colonna telescopica ad altezza regolabile, soffione in abs, doccetta in ABS a 3 funzioni con pulsante per il cambio dell'intensità, flessibile 150cm.

Thermostatic shower column set, including: exposed thermostatic mixer for column, height-adjustable telescopic column, abs shower head, 3-function abs hand shower with button for jets mode switching, 150cm flexible hose.

ZT636A3CPSD20

Con soffione doccia 20x20cm
With shower head 20x20cm

ZT636A3CPSD25

Con soffione doccia 25x25cm
With shower head 25x25cm

ZT636A3CPSD30

Con soffione doccia 30x30cm
With shower head 30x30cm



Set colonna doccia termostatico, composto da: miscelatore termostatico esterno per colonna, colonna telescopica ad altezza regolabile, soffione in ottone, doccetta quadrata in ottone a 1 funzione, flessibile 150cm.

Thermostatic shower column set, including: exposed thermostatic mixer for column, height-adjustable telescopic column, brass shower head, 1-function squared brass hand shower, 150cm flexible hose.

ZT636BA495590

Con soffione doccia 20x20cm
With shower head 20x20cm

ZT636BA49593B

Con soffione doccia 25x25cm
With shower head 25x25cm

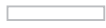

KIT WELLNESS - WELLNESS KIT

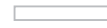

SKT615ZSSCA

Set doccia a incasso, composto da: miscelatore termostatico a incasso con deviatore 3 vie e 7 posizioni, attacco presa acqua a muro con supporto snodato per doccetta, soffione a parete in acciaio inox lucidato a specchio con getto pioggia e cascata, doccetta quadrata in ottone a 1 funzione, flessibile 150cm.

Built-in shower set, including: built-in thermostatic mixer with 3-way 7-position diverter, wall water connection with adjustable hand shower holder, wall-mounted shower head in mirror-polished stainless steel with rain and waterfall jets, 1-function squared brass hand shower, 150cm flexible hose.



CR



SKT615Z

Set doccia a incasso, composto da: miscelatore termostatico a incasso con deviatore, attacco presa acqua a muro con supporto snodato per doccetta, braccio a muro rettangolare in ottone 30cm, soffione 24x14cm rettangolare in ottone, doccetta quadrata in ottone a 1 funzione, flessibile 150cm.

Built-in shower set, including: built-in thermostatic mixer with diverter, wall water connection with adjustable hand shower holder, 30cm rectangular brass wall arm, 24x14cm rectangular brass shower head, 1-function squared brass hand shower, 150cm flexible hose.



CR

FIN A

FIN B

SKT615ZSS

Con soffione a parete in acciaio inox lucidato a specchio,
With wall-mounted shower head in mirror-polished stainless steel.

CR

SKT615S

Con braccio a soffitto squadrato in ottone 30cm, soffione 24x14cm rettangolare in ottone,
with 30cm squared brass ceiling arm, 24x14cm rectangular brass shower head.

CR

FIN A

FIN B



SKT614ZSSCA

Set doccia a incasso, composto da: miscelatore termostatico a incasso con deviatore 3 vie e 7 posizioni, asta saliscendi squadrata, attacco presa acqua a muro, soffione a parete in acciaio inox lucidato a specchio con getto pioggia e cascata, doccetta quadrata in ottone a 1 funzione, flessibile 150cm.

Built-in shower set, including: built-in thermostatic mixer with 3-way 7-position diverter, squared sliding rail, wall water connection, wall-mounted shower head in mirror-polished stainless steel with rain and waterfall jets, 1-function squared brass hand shower, 150cm flexible hose.



CR



SKT614Z

Set doccia a incasso, composto da: miscelatore termostatico a incasso con deviatore, asta saliscendi squadrata, attacco presa acqua a muro, braccio a muro rettangolare in ottone 30cm, soffione 24x14cm rettangolare in ottone, doccetta quadrata in ottone a 1 funzione, flessibile 150cm.

Built-in shower set, including: built-in thermostatic mixer with diverter, squared sliding rail, wall water connection, 30cm rectangular brass wall arm, 24x14cm rectangular brass shower head, 1-function squared brass hand shower, 150cm flexible hose.



CR

FIN A

FIN B

SKT614ZSS

Con soffione a parete in acciaio inox lucidato a specchio.
With wall-mounted shower head in mirror-polished stainless steel.

CR

SKT614S

Con braccio a soffitto squadrato in ottone 30cm, soffione 24x14cm rettangolare in ottone.
With 30cm squared brass ceiling arm, 24x14cm rectangular brass shower head.

CR

FIN A

FIN B

LAVELLI SINKS



SG284DJ

ACQUA DEPURATA - *PURIFIED WATER* pag 518

ESTRAIBILI - *PULL-OUT* pag 526

DESIGN pag 532

GOURMET pag 540

TOUCH-ME pag 552

CONTEMPORARY pag 556

ACQUA DEPURATA PURIFIED WATER

Una selezione di miscelatori per cucina dedicati alla gestione dell'acqua depurata. Senza dover installare un secondo rubinetto, è possibile utilizzare un miscelatore a 3 vie per gestire sia l'acqua corrente calda/fredda che l'acqua proveniente da un depuratore esterno. Una vasta gamma di proposte differenti per design e tecnologie impiegate, per soddisfare ogni richiesta in termini di estetica progettuale e di budget.

A kitchen faucets selection to manage the purified water supply directly from the sink mixer. Without having to install a second tap, it is possible to use a 3-way mixer to manage both: the hot/cold running water and the drinkable water coming from an external purifier. A wide range of proposals different for design and applied technologies, to satisfy every request in terms of aesthetics and budget.



SG679DW890CR

KIT ACQUA DEPURATA

PURIFIED WATER KIT

Erogare l'acqua potabile filtrata direttamente dal rubinetto della cucina riduce drasticamente il consumo di bottiglie di plastica, i costi di trasporto e le conseguenti emissioni di CO₂.

Grazie alla collaborazione con BWT, nascono i KIT ACQUA DEPURATA: un'alternativa completa, sostenibile ed ecologica all'acqua in bottiglia.

Il miscelatore a 3 vie permette di accedere da un unico rubinetto sia all'acqua corrente che all'acqua depurata, mantenendo le due erogazioni separate per una totale sicurezza.

Il filtro BWT installato sotto il lavello rimuove dall'acqua corrente solidi e particelle sospese nonché odori e sapori indesiderati, per un'acqua buona, sana e a km zero.

Filtered drinking water directly from the kitchen tap drastically reduces the consumption of plastic bottles, transport costs and the resulting CO₂ emissions.

Thanks to the collaboration with BWT, the PURIFIED WATER KITS are available: a complete, sustainable and ecological alternative to bottled water.

The 3-way mixer allows access to both running water and purified water from a single tap, keeping the two outlets separated for total safety.

The BWT filter installed under the sink removes solids and suspended particles from running water as well as unwanted smell and taste, for good, healthy and zero km water.

I KIT ACQUA DEPURATA includono:

The PURIFIED WATER KITS include:



1

MISCELATORE A 3-VIE PER LAVELLO

Miscelatore a 3-vie per lavello con leva di miscelazione per acqua corrente calda/fredda e selettore laterale per acqua depurata. Percorsi di erogazione separati, aeratori separati. Bocca girevole. Raccordi di collegamento inclusi.

3-WAY MIXER FOR SINK

3-way sink mixer with mixing lever for hot / cold running water and side selector for purified water. Separate dispensing paths, separate aerators. Swivel mouth. Connection fittings included.

2

MONITOR

Il monitor viene installato sotto il lavello e permette di verificare in ogni momento lo stato del filtro. Consiste in un'unità di conteggio programmabile e collegata al filtro tramite un sensore di flusso per indicarne la capacità in tempo reale. Il monitor avvisa tramite un segnale acustico, quando il filtro è in esaurimento e quando è necessario sostituirlo.

MONITOR

The monitor is installed under the sink and allows you to check the status of the filter at any time. It consists of a programmable counting unit connected to the filter via a flow sensor to indicate filter capacity in real time. The monitor also alerts you with an audible signal when the filter is low and when it needs to be replaced.

3

FILTRO

Cartuccia filtrante BWT Bewapur HQ. Cartuccia a struttura composta in grado di trattenere impurità fino a 0,5 micron e rimuovere dall'acqua odori, sapori, colorazioni e corpi estranei non graditi. Il filtro viene installato direttamente sotto il lavandino, collegato sia alla rete idrica che al miscelatore. Capacità del filtro a 12° dH 6000 l.

FILTER

BWT filter cartridge with BWT Bewapur HQ drink filter. Composite structure cartridge to retain impurities up to 0.5 microns and remove unwanted smells, flavours, colours and foreign bodies from the water. The filter is installed under the sink, connected to both the water supply outlet and the mixer. Filter capacity at 12° dH 6000 l.

4

TESTATA PORTA FILTRO

FILTER HOLDER

CARATTERISTICHE TECNICHE:

TECHNICAL FEATURES:

Tipo di filtro - <i>Filter type</i>	Bewapur HQ S / Item code A890
Autonomia del filtro - <i>Filter life</i>	6000 litri - liter *
Finezza di filtrazione media - <i>Average filtration finenes</i>	0,5 micron
Portata nominale del fitlo max. - <i>Max. nominal flow rate of the filter</i>	3,3 l/min
Dimensioni filtro + testata di connessione - <i>Filter size + connection head (H x D)</i>	270 x 100 mm

	FILTRI - FILTERS	RUBINETTO - TAP
Pressione di esercizio - <i>Operating pressure</i>	2 - 7 bar **	1 - 5 bar **
Temperatura consigliata ingresso acqua calda - <i>Recommended hot water inlet temperature</i>	-	60°C
Temperatura dell'acqua min. / max. - <i>Water temperature min. / max.</i>	4 - 30°C	4 - 80°C
Temperatura ambiente min. / max. - <i>Room temperature min. / max.</i>	4 - 40°C	4 - 40°C

* L'autonomia del filtro può variare in funzione della qualità dell'acqua di alimento. Sostituire il filtro al raggiungimento dell'autonomia o al massimo dopo un anno.
The autonomy of the filter may vary depending on the quality of incoming water. Replace the filter upon reaching autonomy or at the latest after one year.

** Per pressioni superiori prevedere l'utilizzo di un riduttore di pressione
For higher pressures, use a pressure reducer

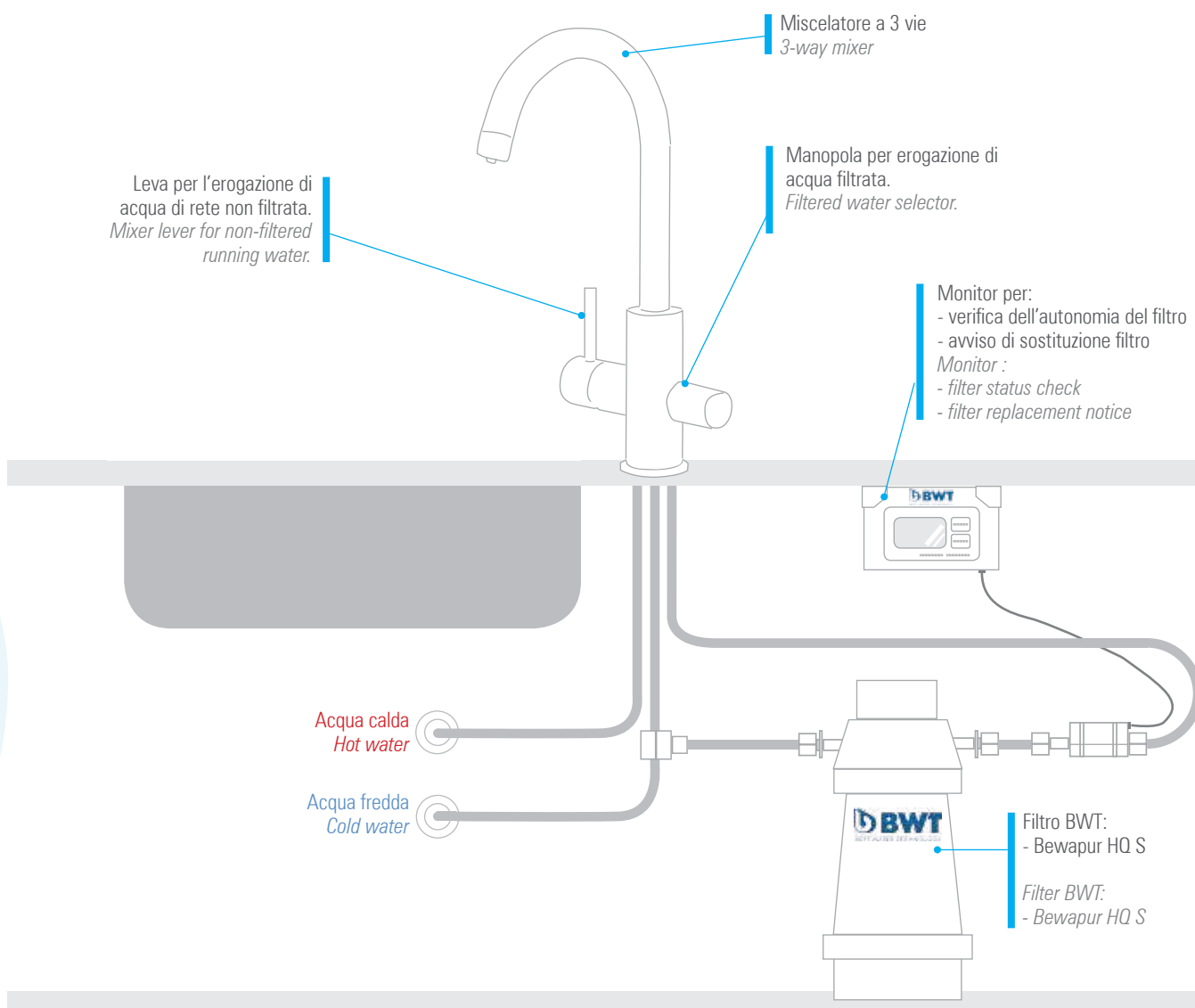



S20679DW890CR

Kit completo per acqua depurata, include: miscelatore a 3-vie per lavello S20679DW con selezione acqua potabile tramite leva laterale, monitor, testata e cartuccia filtrante A890 (BWT Bewapur HQ S).

Complete kit for purified water, including: 3-way sink mixer with drinking water selection via side lever, monitor, head and A890 filter cartridge (BWT Bewapur HQ S).



CR



RX679DW890CR

Kit completo per acqua depurata, include: miscelatore a 3-vie RX679DW per lavello con selezione acqua potabile tramite leva laterale, monitor, testata e cartuccia filtrante A890 (BWT Bewapur HQ S).

Complete kit for purified water, including: 3-way sink mixer RX679DW with drinking water selection via side lever, monitor, head and A890 filter cartridge (BWT Bewapur HQ S).



CR



OM679DW890CR

Kit completo per acqua depurata, include: miscelatore a 3-vie OM679DW per lavello con selezione acqua potabile tramite leva laterale, monitor, testata e cartuccia filtrante A890 (BWT Bewapur HQ S).

Complete kit for purified water, including: 3-way sink mixer OM679DW with drinking water selection via side lever, monitor, head and A890 filter cartridge (BWT Bewapur HQ S).



CR



A890

Cartuccia filtrante per ricambio BWT Bewapur HQ S, autonomia 6000 litri*.

BWT Bewapur HQ S replacement filter cartridge, autonomy 6000 liters.*



*L'autonomia del filtro può variare in funzione della qualità dell'acqua di alimento. Sostituire il filtro al raggiungimento dell'autonomia o al massimo dopo un anno.
The autonomy of the filter may vary depending on the quality of incoming water. Replace the filter upon reaching autonomy or at the latest after one year.

CR



Acqua corrente miscelata.
Mixed running water.

Acqua depurata.
Purified water.

Due canali di erogazione
interni differenziati.
*Two separated internal
dispensing paths.*

Bocca girevole.
Swivel spout.

Leva di miscelazione per la
tradizionale gestione dell'acqua
corrente calda e fredda.
*Mixing lever for the traditional
hot and cold running water
management.*

Selettore acqua potabile.
Ruotare di 90° in senso orario
per erogare l'acqua depurata.
*Drinking water selector.
Turn 90° clockwise to
dispense the purified water.*

ACQUA DEPURATA
PURIFIED WATER

ESTRAIBILI
PULL-OUT

DESIGN

GOURMET

TOUCH-ME

CONTEMPORARY



S20679DW

Miscelatore lavello a 3 vie di ingresso con bocca girevole e due vie d'uscita completamente indipendenti per acqua depurata e acqua corrente. Selezione dell'acqua depurata tramite deviatore laterale.
3-ways sink mixer with swivel spout and two completely independent outlets for purified water and running water. Selection of purified water from side diverter.

CR FIN A FIN B



TA679DW

Miscelatore lavello a 3 vie di ingresso con bocca girevole e due vie d'uscita completamente indipendenti per acqua depurata e acqua corrente. Selezione dell'acqua depurata tramite deviatore laterale.
3-ways sink mixer with swivel spout and two completely independent outlets for purified water and running water. Selection of purified water from side diverter.

CR FIN A FIN B



OM679DW

Miscelatore lavello a 3 vie di ingresso con bocca girevole e due vie d'uscita completamente indipendenti per acqua depurata e acqua corrente. Selezione dell'acqua depurata tramite deviatore laterale.
3-ways sink mixer with swivel spout and two completely independent outlets for purified water and running water. Selection of purified water from side diverter.

CR FIN A FIN B

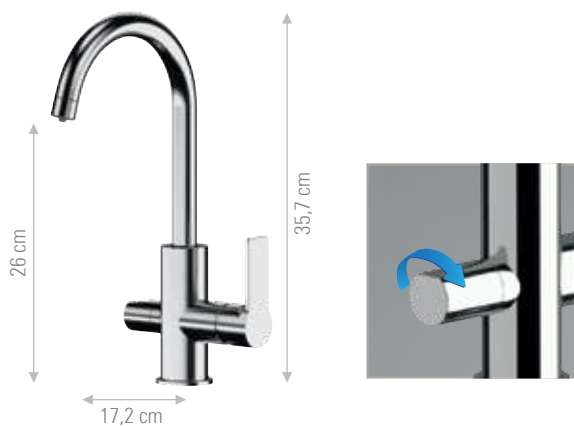

RX679DW

Miscelatore lavello a 3 vie di ingresso con bocca girevole e due vie d'uscita completamente indipendenti per acqua depurata e acqua corrente. Selezione dell'acqua depurata tramite deviatore laterale.
3-ways sink mixer with swivel spout and two completely independent outlets for purified water and running water. Selection of purified water from side diverter.

CR FIN A FIN B



S20679TFDW

Miscelatore monocomando a 3+2 vie con tastiera elettronica di selezione per gestire fino a 3 ingressi (ad esempio depurata, frizzante e rinfrescata). Da collegare agli appositi apparecchi di depurazione, gassificazione e/o filtri. La tastiera elettronica permette di selezionare l'ingresso desiderato per poi attivare ed interrompere l'erogazione corrispondente. La leva di miscelazione regola invece l'acqua calda/fredda non filtrata secondo la funzionalità tradizionale. Alimentazione elettrica sottolavabo.

3+2-way single-lever mixer with electronic keyboard selection to manage up to 3 inputs (for example purified, sparkling and refreshed). To be connected to the appropriate purification, gasification devices and/or filters. The electronic keyboard allows to select the desired input and then to activate and to stop the corresponding water delivery. The mixing lever instead regulates the unfiltered hot/cold water according to traditional functionality. Under-sink electric power supply.



NOTA - NOTE

Per la gestione di 3 tipologie di acqua differenti, il miscelatore deve essere collegato ad un apparecchio di depurazione esterno e ad una valvola a 3 ingressi (non inclusi nel prodotto).
To manage 3 different types of water, the mixer must be connected to an external purifier system and to a 3-inlet valve (not included in the product).

KITEVTFDW
 Elettrovalvola a 3 ingressi
 3-inlet valve



S20608DW

Miscelatore lavello a tre vie di ingresso con bocca girevole, con selezione acqua potabile tramite la leva, con 2 aeratori indipendenti in uscita.
Three ways inlet single lever sink mixer, with swivel spout, with selection for drinking water directly from the lever, with 2 independent exit aerators.

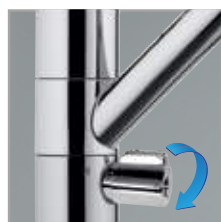

ES5629DW

Miscelatore lavello a tre vie di ingresso con bocca girevole, con selezione acqua potabile tramite leva, con 2 aeratori in uscita.

Tree ways inlet single lever sink mixer, with swivel spout, with selection for drinking water directly from the lever, with 2 exit aerators.



ES5622

Miscelatore lavello monoforo con selettore acqua potabile (3 vie d'ingresso).

Single-lever sink mixer with selector for drinking water (3 ways inlet).



ESTRAIBILI PULL-OUT

I miscelatori per lavello con doccetta estraibile aggiungono comfort e funzionalità alla tua cucina. Con la doccetta estraibile sarà infatti possibile direzionare il getto e avvicinarlo agli oggetti da lavare (alimenti, stoviglie o il lavello stesso), rendendo ogni operazione più pratica e precisa. La doccetta estraibile permette inoltre di operare su un'area di lavoro più grande, riempiendo pentole e bicchieri posti al di fuori del lavello.

Sink mixers with pull-out spray add comfort and functionality to your kitchen. Pull-out shower makes easy to direct the jet and bring it closer to the objects you need to wash (food, dishes or the sink itself), making every operation more practical and precise. The pull-out shower also allows you to operate on a larger work area, filling pots and glasses placed outside the sink.



SG284DJ



SG281M

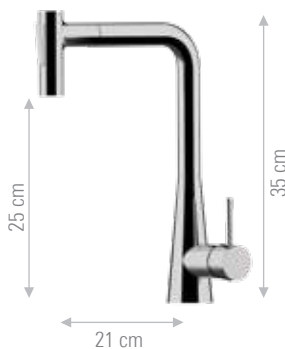

SG281M

Miscelatore monocomando per lavello, con base conica, canna alta girevole e doccetta estraibile con impugnatura a martello a due funzioni.

Single-lever sink mixer with conical base, high swivel spout and 2-functions pull-out "hammer shaped" handle hand shower.



RX681M

Miscelatore monocomando per lavello, con canna alta girevole e doccetta estraibile con impugnatura a martello a due funzioni.

Single-lever sink mixer with high swivel spout and 2-functions pull-out "hammer shaped" handle hand shower.

CR

CR



ACQUA DEPURATA
PURIFIED WATER

ESTRAIBILI
PULL-OUT

DESIGN

GOURMET

TOUCH-ME

CONTEMPORARY

SG284



SG284

Miscelatore monocomando per lavello con base conica, canna alta girevole e sistema di doccetta monofunzione estraibile.

Single-lever sink mixer with conical base, high swivel spout and 1-function pull-out hand shower.

39 cm

26,4 cm

18,2 cm

CR

FIN A

FIN B



RX684DJ

Miscelatore monocomando per lavello, con canna alta girevole e doccetta estraibile a due funzioni. *Single-lever sink mixer with high swivel spout and 2-functions pull-out hand shower.*

38 cm

19,8 cm

20 cm

CR



RX684





PR21627

Miscelatore monocomando lavello con bocca alta girevole e doccetta estraibile. Regolazione con cartuccia a dischi ceramici Ø35 mm.
Single-lever sink mixer with high swivel spout and pull-out shower. Adjust with cartridge with ceramic discs Ø35.



S20613

Miscelatore monocomando lavello con doccia estraibile.
Single-lever sink mixer with pull-out spray-jet shower.



S20613

ACQUA DEPURATA
PURIFIED WATER

ESTRAIBILI
PULL-OUT

DESIGN

GOURMET

TOUCH-ME

CONTEMPORARY

DESIGN

I miscelatori per lavello della sezione DESIGN presentano forme moderne ed eleganti, perfette per inserire un prezioso dettaglio di stile nella vostra cucina.

The sink mixers of the DESIGN section consist of modern and elegant shapes, perfect for inserting a precious style detail in your kitchen.



SG274U



SG274U

Miscelatore monocomando lavello con bocca alta girevole.
Single-lever sink mixer with high swivel spout.

CR	FIN A	FIN B
----	-------	-------



ACQUA DEPURATA
PURIFIED WATER

ESTRAIBILI
PULL-OUT

DESIGN

GOURMET

TOUCH-ME

CONTEMPORARY



SG274

Miscelatore monocomando lavello con bocca alta a girevole.
Single-lever sink mixer with high swivel spout.

- CR
- FIN A
- FIN B



RX618Q

Miscelatore monocomando per lavello, con bocca alta girevole.
Single lever kitchen mixer with high swivel spout.

CR	FIN A	FIN B
----	-------	-------



ACQUA DEPURATA
PURIFIED WATER

ESTRAIBILI
PULL-OUT

DESIGN

GOURMET

TOUCH-ME

CONTEMPORARY



SK617

Miscelatore monocomando per lavello, con bocca alta girevole.
Single-lever one-hole sink mixer, with high swivel spout.

- CR
- FIN A
- FIN B



DV608

Monocomando lavello girevole.
Swivelling single-lever Sink mixer.



CR FIN A FIN B

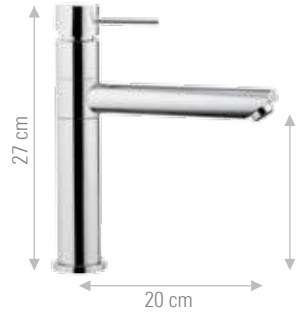

S20608

Monocomando lavello con bocca girevole.
Single lever one-hole sink mixer, with swivel spout.

CR FIN A FIN B



PR21619

Miscelatore monocomando lavello con bocca alta girevole. Regolazione con cartuccia a dischi ceramici Ø35 mm.
Single-lever sink mixer with high swivel spout. Adjust with cartridge with ceramic discs Ø35 mm.

CR FIN A FIN B



S20638

Miscelatore monocomando laterale per lavello, alto, con bocca girevole a molla in acciaio inox elettrolucidato, flessibile in acciaio inox ricoperto in pvc metallizzato e doccetta monogetto. Materiale: miscelatore in ottone cromato, con doccetta in ottone.
Single-lever mixer for sink, with side lever, high swivel spring spout in stainless steel electro polished with shower. Material: mixer in c.p. brass, spout in stainless steel with stainless steel flexible covered with silver colour pvc, hand shower in c.p. brass.

CR



S20680

Miscelatore monocomando laterale per lavello, alto, con bocca girevole. Materiale: miscelatore in ottone cromato. Canna: forma a 180°, girevole, Ø24 mm, in ottone cromato.
Single-lever mixer for sink, with side lever, high swivel spout. Material: mixer and spout in c.p. brass. Spout: shape 180°, swivelling, Ø24 mm.

CR FIN A FIN B



TX618

Miscelatore monocomando monoforo per lavello con canna alta girevole.
Single-lever sink mixer, high swivel spout.

CR FIN A FIN B



GOURMET

La sezione GOURMET raccoglie una selezione di miscelatori dedicati ai grandi lavelli di isole e penisole da cucina. L'altezza e lo spazio sotto la bocca permettono di sfruttare una grande area di lavoro, la doccetta estraibile dal supporto e direzionabile permette di raggiungere anche gli angoli delle vasche più ampie e profonde.

The GOURMET section collects a selection of mixers dedicated to the large sinks and kitchen islands. The height and the space under the mixer spout allow you to take advantage of a larger work area, the hand shower can be removed from its holder and used freely to reach even the corners of the widest and deepest bathtubs.

*This kitchen is
seasoned*



GOURMET

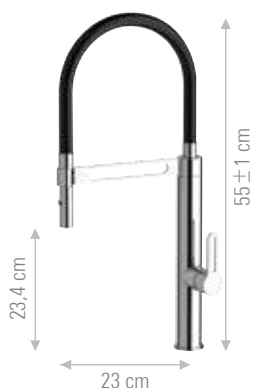

SR211

Miscelatore lavello con flessibile rivestito in tubo gomma soft-touch nero opaco. Doccetta sganciabile a 2 funzioni.

Sink mixer with flexible hose coated in soft-touch matte black rubber pipe. 2-function detachable sprayer.

CR

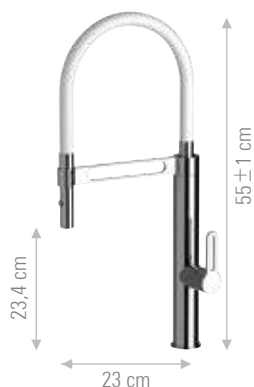

SR215

Miscelatore lavello con flessibile rivestito in tubo gomma soft-touch bianco opaco. Doccetta sganciabile a 2 funzioni.

Sink mixer with flexible hose coated in soft-touch matte white rubber pipe. 2-function detachable sprayer.

CR

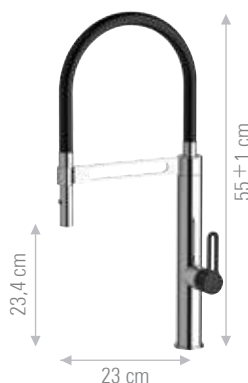

SR212

Miscelatore lavello con flessibile rivestito in tubo gomma soft-touch nero opaco, maniglia verniciata nera opaca. Doccetta sganciabile a 2 funzioni.

Sink mixer with flexible hose coated in soft-touch matte black rubber pipe, matt black painted handle. 2-function detachable sprayer.

CR

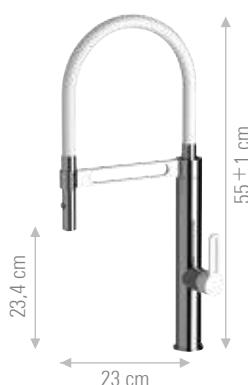

SR216

Miscelatore lavello con flessibile rivestito in tubo gomma soft-touch bianco opaco, maniglia verniciata bianca opaca. Doccetta sganciabile a 2 funzioni.

Sink mixer with flexible hose coated in soft-touch matte white rubber pipe, matt white painted handle. 2-function detachable sprayer.

CR

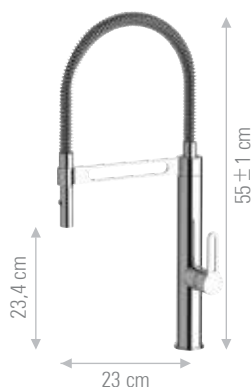

SR213

Miscelatore lavello con flessibile nero rivestito con molla "fine design". Doccetta sganciabile a 2 funzioni.

Sink mixer with black flexible hose coated with "fine design" spring. 2-function detachable sprayer.

CR

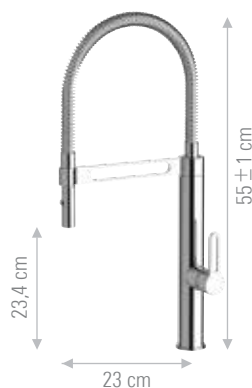

SR214

Miscelatore lavello con flessibile bianco rivestito con molla "fine design". Doccetta sganciabile a 2 funzioni.

Sink mixer with black flexible hose coated with "fine design" spring. 2-function detachable sprayer.

CR



ACQUA DEPURATA
PURIFIED WATER

ESTRAIBILI
PULL-OUT

DESIGN

GOURMET

TOUCH-ME

CONTEMPORARY

SR216



SR241

Miscelatore lavello con flessibile rivestito in tubo gomma soft-touch nero opaco. Doccetta sganciabile a 2 funzioni.
Sink mixer with flexible hose coated in soft-touch matte black rubber pipe. 2-function detachable sprayer.

CR



SR245

Miscelatore lavello con flessibile rivestito in tubo gomma soft-touch bianco opaco. Doccetta sganciabile a 2 funzioni.
Sink mixer with flexible hose coated in soft-touch matte white rubber pipe. 2-function detachable sprayer.

CR



SR242

Miscelatore lavello con flessibile rivestito in tubo gomma soft-touch nero opaco, maniglia verniciata nera opaca. Doccetta sganciabile a 2 funzioni.
Sink mixer with flexible hose coated in soft-touch matte black rubber pipe, matt black painted handle. 2-function detachable sprayer.

CR



SR246

Miscelatore lavello con flessibile rivestito in tubo gomma soft-touch bianco opaco, maniglia verniciata bianca opaca. Doccetta sganciabile a 2 funzioni.
Sink mixer with flexible hose coated in soft-touch matte white rubber pipe, matt black painted handle.

CR



RX241

Miscelatore lavello con flessibile rivestito in tubo gomma soft-touch nero opaco. Doccetta sganciabile a 2 funzioni.
Sink mixer with flexible hose coated in soft-touch matt black rubber pipe. 2-function detachable sprayer.

CR



RX245

Miscelatore lavello con flessibile rivestito in tubo gomma soft-touch bianco opaco. Doccetta sganciabile a 2 funzioni.
Sink mixer with flexible hose coated in soft-touch matte white rubber pipe. 2-function detachable sprayer.

CR



ACQUA DEPURATA
PURIFIED WATER

ESTRAIBILI
PULL-OUT

DESIGN

GOURMET

TOUCH-ME

CONTEMPORARY

SR241



SR243

Miscelatore lavello con flessibile nero rivestito con molla "fine design". Doccetta sganciabile a 2 funzioni.
Sink mixer with black flexible hose coated with "fine design" spring. 2-function detachable sprayer.

CR



SR244

Miscelatore lavello con flessibile bianco rivestito con molla "fine design". Doccetta sganciabile a 2 funzioni.
Sink mixer with white flexible hose coated with "fine design" spring. 2-function detachable sprayer.

CR



RX243

Miscelatore lavello con flessibile nero rivestito con molla "fine design". Doccetta sganciabile a 2 funzioni.
Sink mixer with black flexible hose coated with "fine design" spring. 2-function detachable sprayer.

CR



RX244

Miscelatore lavello con flessibile bianco rivestito con molla "fine design". Doccetta sganciabile a 2 funzioni.
Sink mixer with white flexible hose coated with "fine design" spring. 2-function detachable sprayer.

CR



ACQUA DEPURATA
PURIFIED WATER

ESTRAIBILI
PULL-OUT

DESIGN

GOURMET

TOUCH-ME

CONTEMPORARY

SR244

TA233



Miscelatore lavello monocomando con flessibile nero rivestito con molla "fine design" girevole 360°, con doccetta estraibile di supporto ed orientabile a due funzioni. Cartuccia Ø 35.
Single-lever mixer with black flexible hose coated with "fine design" spring, swivel 360°, with detachable and adjustable 2-functions hand shower. Ø 35 mm cartridge.

CR
 € 485,40

S20233

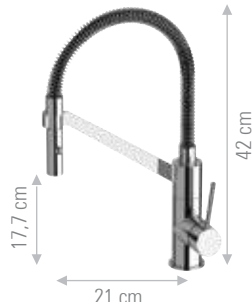

Miscelatore lavello monocomando con flessibile nero rivestito con molla "fine design" girevole 360°, con doccetta estraibile ed orientabile a due funzioni. Cartuccia Ø 35.
Single-lever mixer with black flexible hose coated with "fine design" spring, swivel 360°, with pull-out and swivelling 2-functions hand shower. Ø 35 mm cartridge.

CR
 € 500,10

OM233



Miscelatore lavello monocomando con flessibile nero rivestito con molla "fine design" girevole 360°, con doccetta estraibile di supporto ed orientabile a due funzioni. Cartuccia Ø 35.
Single-lever mixer with black flexible hose coated with "fine design" spring, swivel 360°, with detachable and adjustable 2-functions hand shower. Ø 35 mm cartridge.

CR
 € 485,10

SR233

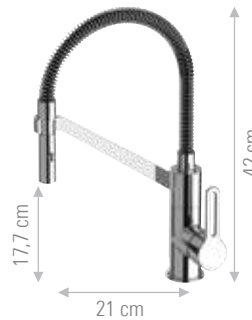

Miscelatore lavello monocomando con flessibile nero rivestito con molla "fine design" girevole 360°, con doccetta estraibile ed orientabile a due funzioni. Cartuccia Ø 35.
Single-lever mixer with black flexible hose coated with "fine design" spring, swivel 360°, with pull-out and swivelling 2-functions hand shower. Ø 35 mm cartridge.

CR
 € 481,40



ACQUA DEPURATA
PURIFIED WATER

ESTRAIBILI
PULL-OUT

DESIGN

GOURMET

TOUCH-ME

CONTEMPORARY

SR233

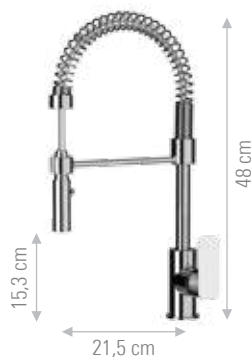

TA689

Miscelatore monocomando lavello a molla con doccetta estraibile dal supporto ed orientabile a due funzioni. Cartuccia Ø 35.
Spring single-lever sink mixer with detachable and adjustable 2-functions hand shower. Ø 35 mm cartridge.

CR

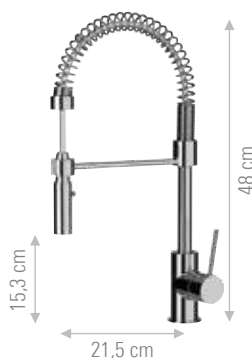

S20689

Miscelatore monocomando lavello a molla con doccetta estraibile ed orientabile a due funzioni. Cartuccia Ø 35.
Spring single-lever sink mixer with pull-out and swivelling 2-functions hand shower. Ø 35 mm cartridge.

CR

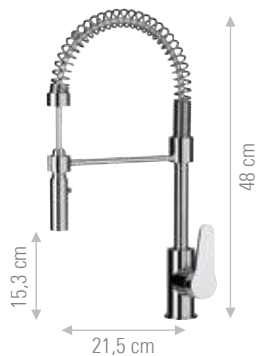

OM689

Miscelatore lavello monocomando a molla con doccetta estraibile ed orientabile a due funzioni. Cartuccia Ø35 mm.
Spring single-lever sink mixer with pull-out and swivelling 2 functions hand shower. Ø35 mm cartridge.

CR

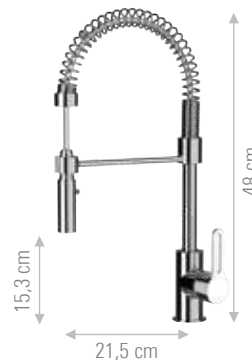

SR689

Miscelatore monocomando lavello a molla con doccetta estraibile ed orientabile a due funzioni. Cartuccia Ø 35.
Spring single-lever sink mixer with pull-out and swivelling 2-functions hand shower. Ø 35 mm cartridge.

CR

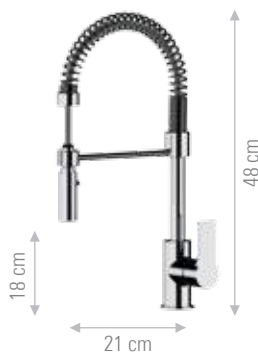

RX689

Miscelatore monocomando lavello a molla con doccetta estraibile ed orientabile a due funzioni. Cartuccia Ø 35.
Spring single-lever sink mixer with pull-out and swivelling 2-functions hand shower. Ø 35 mm cartridge.

CR



ACQUA DEPURATA
PURIFIED WATER

ESTRAIBILI
PULL-OUT

DESIGN

GOURMET

TOUCH-ME

CONTEMPORARY

RX689

TOUCH-ME

I miscelatori da cucina hi-tech con tecnologia TOUCH-ME consentono di attivare e interrompere l'erogazione dell'acqua con un semplice tocco del miscelatore, senza dover intervenire sulla leva di miscelazione. La tecnologia Touch-me si trasforma in un grande vantaggio per l'utente in termini di praticità, igiene, risparmio idrico e velocità in tutte le operazioni della cucina.

The hi-tech kitchen mixers with TOUCH-ME technology allow to activate and stop the water supply with a simple touch of the mixer, without having to intervene on the mixing lever. Touch-me technology turns into a great advantage for the user in terms of practicality, hygiene, water saving and speed in all kitchen operations.





OMT618



I miscelatori da cucina hi-tech con tecnologia TOUCH-ME consentono di attivare e interrompere l'erogazione dell'acqua con un semplice tocco del miscelatore, senza dover intervenire sulla leva di miscelazione.

La tecnologia TOUCH-ME si trasforma in un grande vantaggio per l'utente in termini di praticità, igiene, risparmio idrico e velocità in tutte le operazioni della cucina.

I rubinetti con tecnologia TOUCH-ME sono semplici da utilizzare ed altrettanto facili da installare.

Alimentata a batterie con un'installazione salvaspazio sotto il lavandino, la tecnologia TOUCH-ME non richiede alcun cablaggio elettrico né alcuna manutenzione speciale.

La leva di miscelazione è isolata dal controllo TOUCH-ME, per consentire sempre la regolazione della temperatura e l'utilizzo in modalità manuale.

CARATTERISTICHE TECNICHE:

- Alimentato da 4 batterie AA litio 1,5V.
- Tutti i miscelatori con tecnologia TOUCH-ME possono essere utilizzati anche nella modalità tradizionale, scollegando la funzione TOUCH-ME in qualsiasi momento.
- Prima del blocco da "batteria scarica", le valvole vengono in automatico commutate in posizione aperta e la funzione TOUCH-ME si disattiva permettendo il normale utilizzo del miscelatore fino al cambio batterie.

Il sistema TOUCH-ME è dotato di:

- Due elettrovalvole.
- Un collegamento elettrico per il sensore.
- Una scatola dell'elettronica che include anche le 4 batterie.

The hi-tech kitchen mixers with TOUCH-ME technology allow to activate and stop the water supply with a simple touch of the mixer, without having to intervene on the mixing lever.

Touch-me technology turns into a great advantage for the user in terms of practicality, hygiene, water saving and speed in all kitchen operations.

Faucets with TOUCH-ME technology are simple to be installed and extremely easy to use.

Powered by batteries with a space-saving installation under the sink, Touch-me technology do not require any electrical wiring or any special maintenance, making all the kitchen operations fast and fun, in addition to ensuring water and energy savings.

The mixing lever is excluded from the TOUCH-ME control, to always allow the temperature adjustment and the use in manual mode.

TECHNICAL FEATURES:

- Powered by 4 AA 1.5V lithium batteries.
- All the mixers with TOUCH-ME technology can also be used in the traditional mode, by disconnecting the TOUCH-ME function at any time.
- Before the "discharged battery" lockout, the valves automatically switch to the open position, deactivating the TOUCH-ME function and allowing traditional use of the mixer until the batteries are changed.

The TOUCH-ME system is equipped with:

- Two solenoid valves.
- An electrical connection for the sensor.
- An electronics box that also includes the 4 batteries.

TOUCH-ME



SRT618U

CE LITHIUM

Miscelatore monocomando livello, monoforo 90° con canna alta quadra girevole dotata di tecnologia Touch-Me, leva laterale. Cartuccia Ø35.
Single-lever sink mixer 90°, high swivel squared spout equipped with Touch-Me system, side lever. Ø35 cartridge.

24 cm
33 cm
21,5 cm

CR FIN A FIN B



OMT618U

CE LITHIUM

Miscelatore monocomando livello, monoforo 90° con canna alta quadra girevole dotata di tecnologia Touch-Me, leva laterale. Cartuccia Ø35.
Single-lever sink mixer 90°, high swivel squared spout equipped with Touch-Me system, side lever. Ø35 cartridge.

24 cm
33 cm
21,5 cm

CR FIN A FIN B



SRT618

CE LITHIUM

Miscelatore monocomando livello, monoforo 90° con canna alta quadra girevole dotata di tecnologia Touch-Me, leva laterale. Cartuccia Ø35.
Single-lever sink mixer 90°, high swivel squared spout equipped with Touch-Me system, side lever. Ø35 cartridge.

24 cm
34 cm
17 cm

CR FIN A FIN B



OMT618

CE LITHIUM

Miscelatore monocomando livello, monoforo 90° con canna alta quadra girevole dotata di tecnologia Touch-Me, leva laterale. Cartuccia Ø35.
Single-lever sink mixer 90°, high swivel squared spout equipped with Touch-Me system, side lever. Ø35 cartridge.

24 cm
34 cm
17,5 cm

CR FIN A FIN B



SKT617

CE LITHIUM

Miscelatore monocomando per lavello, con bocca alta girevole squadrata, dotato di tecnologia touch-me. Cartuccia Ø35.
Single-lever one-hole sink mixer, with high squared spout, and equipped with touch-me technology. Ø35 cartridge.

31,5 cm
29 cm
22 cm

CR FIN A FIN B



TAT618

CE LITHIUM

Miscelatore monocomando livello, monoforo 90° con canna alta girevole dotata di tecnologia Touch-Me, leva laterale. Cartuccia Ø35.
Single-lever sink mixer 90°, high swivel spout equipped with Touch-Me system, side lever. Ø35 cartridge.

24 cm
34 cm
17,5 cm

CR FIN A FIN B

ACQUA DEPURATA
PURIFIED WATER

ESTRAIBILI
PULL-OUT

DESIGN

GOURMET

TOUCH-ME

CONTEMPORARY

CONTEMPORARY

CONTEMPORARY è una selezione di rubinetti e miscelatori per il lavello della cucina dal design semplice che coniuga la sicurezza di alti standard qualitativi con la libertà di scegliere tra un'ampia proposta di stili e finiture.

CONTEMPORARY is a selection of taps and mixers for the kitchen sink with a simple design that combines the safety of high quality standards with the freedom to choose from a wide range of styles and finishing.



RX614B



OM614B

Miscelatore monocomando per lavello, con bocca alta girevole.
Single-lever one-hole sink mixer, with high swivel spout.

CR FIN A FIN B



TA614B

Miscelatore monocomando per lavello, con bocca alta girevole.
Single-lever one-hole sink mixer, with high swivel spout.

CR FIN A FIN B



SR614B

Miscelatore monocomando per lavello, con bocca alta girevole.
Single-lever one-hole sink mixer, with high swivel spout.

CR FIN A FIN B



RX614B

Miscelatore monocomando per lavello, con bocca alta girevole.
Single-lever one-hole sink mixer, with high swivel spout.

CR FIN A FIN B



RX614T

Miscelatore lavello monoforo 45° con bocca alta girevole.
Single-lever sink mixer 45° with high swivel spout.

CR FIN A FIN B



OM614T

Miscelatore lavello monoforo 45° con bocca alta girevole.
Single-lever sink mixer 45° with high swivel spout.

CR FIN A FIN B



OM617

Miscelatore lavello monoforo 45° con canna alta girevole.
Single-lever sink mixer 45° with high swivel spout.

CR FIN A FIN B



OM629

Monocomando lavello con canna girevole.
Single-lever sink mixer with swiveling spout.

CR FIN A FIN B

— SOTTOFINESTRA - UNDER-WINDOW —



RX614R
 Miscelatore monocomando lavello per installazione sottofinestra, con bocca alta girevole e reclinabile, tipo lusso.
Single-lever sink mixer for under window installation, with high swivel reclining spout, luxury type.

29 cm
 19,5 cm

CR FIN A FIN B



OM614R
 Miscelatore monocomando lavello per installazione sottofinestra, con bocca alta girevole e reclinabile, tipo lusso.
Single-lever sink mixer for under window installation, with high swivel reclining spout, luxury type.

29 cm
 19,5 cm

CR FIN A FIN B

— A PARETE - WALL MOUNTING —



OM609T
 Miscelatore lavello a muro con canna girevole.
Wall-mounted single-lever sink mixer with swivel spout.

20 cm

CR FIN A FIN B



SK609
 Miscelatore lavello a muro con canna girevole.
Wall-mounted single-lever sink mixer with swivel spout.

20 cm

CR FIN A FIN B



RX609T
 Miscelatore lavello a muro con canna girevole.
Wall-mounted single-lever sink mixer with swivel spout.

20 cm

CR FIN A FIN B



SR633B
 Miscelatore lavello a muro, con leva frontale e canna alta girevole.
Single-lever wall mounted sink mixer with frontal lever and high swivel spout.

27 cm
 17,5 cm

CR FIN A FIN B



RX633
 Miscelatore monocomando lavello a muro, con leva frontale e bocca alta girevole.
Single-lever wall mounted sink mixer with frontal lever and high swivel spout.

20 cm
 25 cm
 19 cm

CR FIN A FIN B



SR633
 Miscelatore monocomando lavello a muro, con leva frontale e bocca alta girevole.
Single-lever wall mounted sink mixer with frontal lever and high swivel spout.

20 cm
 25 cm
 19 cm

CR FIN A FIN B

ACQUA DEPURATA
 PURIFIED WATER

ESTRAIBILI
 PULL-OUT

DESIGN

GOURMET

TOUCH-ME

CONTEMPORARY



COMPLEMENTI
COMPLEMENTS



VOGUE	pag 562
WIRE	pag 564
HILTON	pag 566
REVIVAL	pag 568
ACCESSORI - <i>ACCESSORIES</i>	pag 570
SISTEMA WC - <i>WC SYSTEM</i>	pag 574
SIFONI - <i>TRAPS</i>	pag 576
PILETTE - <i>DRAIN</i>	pag 580
RUBINETTI SOTTOLAVABO - <i>ANGLE VALVES</i>	pag 584
RICAMBI - <i>SPARE PARTS</i>	pag 588
ESPOSITORI - <i>DISPLAYERS</i>	pag 606

VOGUE



VGDI954



VGDI954

Dispenser per sapone liquido in vetro con supporto in ottone cromato.
Glass soap dispenser with cp brass support.

CR	FIN A	FIN B
----	-------	-------



VGPB940

Portabicchiere in ottone cromato con bicchiere in vetro.
Cp brass cup holder with glass.

CR	FIN A	FIN B
----	-------	-------



VGPS950

Portasapone in vetro con supporto in ottone cromato.
Glass soap dish holder with cp brass support.

CR	FIN A	FIN B
----	-------	-------



VGAP960

Appendino in ottone cromato.
Cp brass hook.

CR	FIN A	FIN B
----	-------	-------



VGPR910

Portarotolo in ottone cromato.
Cp brass toilet paper holder.

CR FIN A FIN B



VGPR911

Portarotolo in ottone cromato.
C.p. brass toilet paper holder.

CR FIN A FIN B

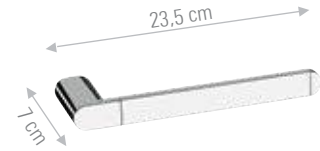

VGPA970

Portasalviette in ottone cromato,
Cp brass towel holder

CR FIN A FIN B

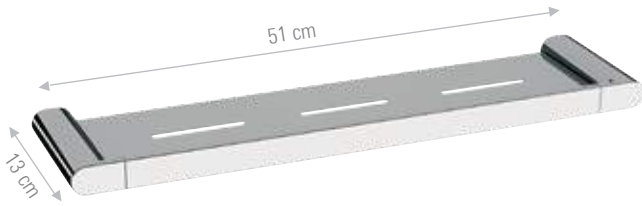

VGME900

Mensola in ottone cromato.
Cp brass shelf.

CR FIN A FIN B



VGPS978

Portasalviette doppio in ottone cromato,
Cp brass double towel holder.

CR FIN A FIN B



VGPS975

Portasalviette, cm 60.
Towel holder, cm 60

CR FIN A FIN B



VGPS973

Portasalviette, cm 40.
Towel holder, cm 40

CR FIN A FIN B

RICAMBI - SPARE PARTS



ACGL950VG

Portasapone.
Soap holder.

CR



ACGL954VG

Dispenser.
Dispenser.

CR FIN A FIN B



ACGL940VG

Bicchiere.
Cup.

CR

WIRE



WIAP960 - WIPR911



WIPB940
Portabicchiere.
Cup holder.

CR FIN A FIN B



WIDI954
Dispenser.
Soap dispenser.

CR



WIPS950
Portasapone.
Soap-dish holder.

CR FIN A FIN B



WIAP960
Appendino doppio.
Double hook.

CR FIN A FIN B



WIPA970
Portasalvietta ad anello.
Ring towel holder.

CR FIN A FIN B



WIPS970
Portasalvietta doppio.
Double towel holder.

CR FIN A FIN B



WIPR910

Portarotolo.
Toilet paper holder.

CR _____ FIN A _____ FIN B _____



WIPR911

Portarotolo.
Toilet paper holder.

CR _____ FIN A _____ FIN B _____



WIME900

Mensola in vetro.
Glass shelf.

CR _____ FIN A _____ FIN B _____



WIPS975

Portasalviette, cm 60.
Towel holder, cm 60

CR _____ FIN A _____ FIN B _____

WIPS973

Portasalviette, cm 40.
Towel holder, cm 40

CR _____ FIN A _____ FIN B _____

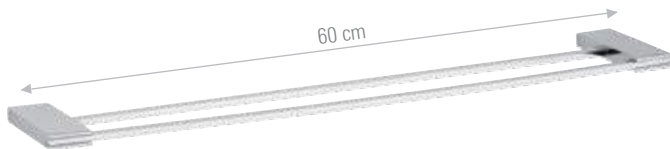

WIPS978

Portasalviette doppio.
Double bar towel holder

CR _____ FIN A _____ FIN B _____



WIPS930

Portascopino.
Broom rack holder.

CR _____ FIN A _____ FIN B _____



WIKIT

Set serie Paris composto da 8 accessori:

- 2 portasapone
- 1 portabicchiere
- 1 portasalviette cm 60
- 1 portasalviette cm 40
- 1 portasalviette ad anello
- 1 appendino
- 1 portarotolo.

Set serie Paris composed of:

- 2 soap dish holder
- 1 cup holder
- 1 towel holder cm 60
- 1 towel holder cm 40
- 1 towel ring
- 1 hook
- 1 toilet paper rooll holder

CR _____ FIN A _____ FIN B _____

RICAMBI - SPARE PARTS



ACSC930WI

Scopino da bagno.
Toilet brush.

CR _____



ACCE950RE

Porta sapone.
Soap Holder.

CR _____



ACCE954NY

Dispenser.
Soap Dispenser.

CR _____



ACCE940NY

Bicchiere.
Glass.

CR _____

VOGUE
WIRE
HILTON
REVIVAL
ACCESSORI
ACCESSORIES
SISTEMA WC
WC SYSTEM
SIFONI
TRAPS
PILETTE
DRAIN
RUBINETTI SOTTOLAVABO
ANGLE VALVES
RICAMBI
SPARE PARTS

HILTON

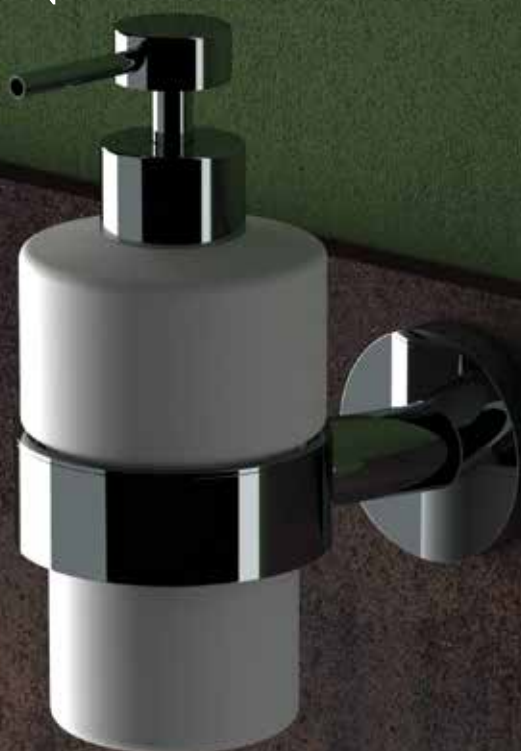

HIDI954



HIPB940

Portabicchiere.
Cup holder.

CR FIN A FIN B



HIPS950

Portasapone.
Soap-dish holder.

CR FIN A FIN B



HIDI954

Dispenser.
Soap dispenser.

CR



HIPS952

Portasapone.
Soap-dish holder.

CR FIN A FIN B



HIPA970

Portasalviette ad
anello.
Ring towel holder.

CR FIN A FIN B



HIPR910

Portarotolo.
Toilet paper holder.

CR FIN A FIN B



HIPRR920

Portarotolo di ricambio.
Spare toilet paper holder.

CR FIN A FIN B



HIPRR922

Portarotolo di ricambio orizzontale.
Horizontal spare toilet paper holder.

CR FIN A FIN B



HIAP960

Appendino.
Hook.

CR FIN A FIN B



HIME900

Mensola in vetro.
Glass shelf.

CR FIN A FIN B



HIPS978

Portasalviette doppio.
Double bar towel holder.

CR FIN A FIN B



HIPS975

Portasalviette, cm 60.
Towel holder, cm 60

CR FIN A FIN B



HIPS973

Portasalviette, cm 40.
Towel holder, cm 40

CR FIN A FIN B



HIPS930

Portascopino.
Broom rack holder.

CR FIN A FIN B



HIKIT

Set serie Paris composto da 8 accessori:

- 2 portasapone
- 1 portabicchiere
- 1 portasalviette cm 60
- 1 portasalviette cm 40
- 1 portasalviette ad anello
- 1 appendino
- 1 portarotolo.

Set serie Paris composed of:

- 2 soap dish holder
- 1 cup holder
- 1 towel holder cm 60
- 1 towel holder cm 40
- 1 towel ring
- 1 hook
- 1 toilet paper roll holder

CR FIN A FIN B

RICAMBI - SPARE PARTS



ACSC930HI

Scopino da bagno.
Toilet brush.

CR



ACCE950RE

Porta sapone.
Soap Holder.

CR



ACCE954NY

Dispenser.
Soap Dispenser.

CR



ACCE940NY

Bicchiere.
Glass.

CR

REVIVAL



REPS950CR



REPB940
Portabicchiere.
Cup holder.

CR FIN A FIN B



REPS950
Portasapone.
Soap-dish holder.

CR FIN A FIN B



REPS952
Portasapone.
Soap holder.

CR FIN A FIN B



REAP960
Appendino doppio.
Double hook.

CR FIN A FIN B



REDI954
Dispenser.
Soap dispenser.

CR FIN A FIN B



REPS930
Portascopino.
Broom rack holder.

CR FIN A FIN B

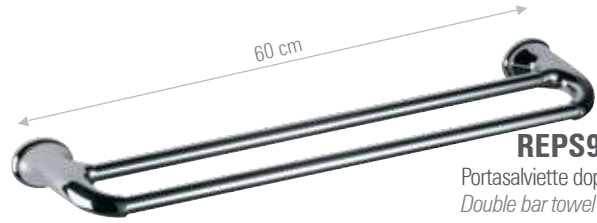
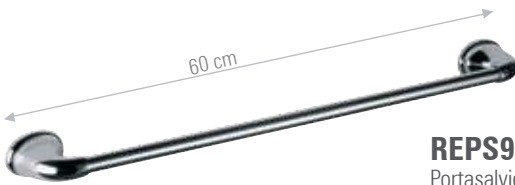
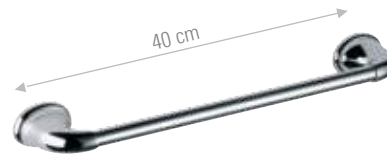
**REPA970**Portasalviette ad anello.
Ring towel holder. CR FIN A FIN B**REPRR920**Portarotolo di ricambio.
Spare toilet paper holder. CR FIN A FIN B**REPR910**Portarotolo.
Toilet paper holder. CR FIN A FIN B**REME900**Mensola in vetro.
Glass shelf. CR FIN A FIN B**REPS978**Portasalviette doppio.
Double bar towel holder. CR FIN A FIN B**REPS975**Portasalviette.
Towel holder. CR FIN A FIN B**REPS973**Portasalviette.
Towel holder. CR FIN A FIN B**REKIT**

Set serie Paris composto da 8 accessori:

- 2 portasapone
- 1 portabicchiere
- 1 portasalviette cm 60
- 1 portasalviette cm 40
- 1 portasalviette ad anello
- 1 appendino
- 1 portarotolo.

Set serie Paris composed of:

- 2 soap dish holder
- 1 cup holder
- 1 towel holder cm 60
- 1 towel holder cm 40
- 1 towel ring
- 1 hook
- 1 toilet paper rooll holder

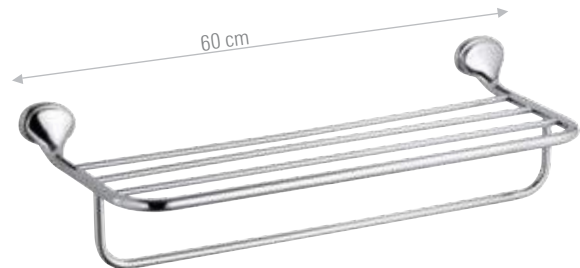
 CR FIN A FIN B**REPS980**Portasalviette quadruplo.
Quadruple towel holder. CR FIN A FIN B

RICAMBI - SPARE PARTS

**ACSC930HI**Scopino da bagno.
Toilet brush. CR**ACCE950RE**Porta sapone.
Soap Holder. CR**ACCE954RE**Dispenser.
Soap Dispenser. CR**ACCE940RE**Bicchiere.
Glass. CR

VOGUE
WIRE
HILTON
REVIVAL
ACCESSORI
ACCESSORIES
SISTEMA WC
WC SYSTEM
SIFONI
TRAPS
PILETTE
DRAIN
RUBINETTI SOTTOLAVABO
ANGLE VALVES
RICAMBI
SPARE PARTS

ACCESSORI BAGNO BATH ACCESSORIES



A2282



A2211

Portasapone piccolo rettangolare.
Rectangular shaped soap holder, small.

CR _____



A2212

Portasapone grande rettangolare.
Rectangular shaped soap holder, big.

CR _____



A2271

Portasapone piccolo angolare.
Corner soap holder, small.

CR _____



A2272

Portasapone grande angolare.
Corner soap holder, big.

CR _____



A2281

Portasapone piccolo ovale.
Oval soap holder, small.

CR _____



A2282

Portasapone grande ovale.
Oval soap holder, big.

CR _____

A2312

Appendiabiti in linea a due ganci.
Clothes holder, two hooks.

CR _____



A2313

Appendiabiti in linea a tre ganci.
Clothes holder, three hook.

CR _____





A2310
 Appendiabito a muro minimale.
Cp brass minimal hook.

CR



A2277
 Portasapone doppio angolare.
Corner double shaped soap holder.

CR



A2430
 Portasalviette, cm 60.
Towel holder, cm 60

CR

A2440
 Portasalviette, cm 40.
Towel holder, cm 40

CR



A2273
 Portasapone angolare.
Corner shaped soap holder.

CR



A2470
 Portasciugamano multiplo da cm 60.
Multiple towel holder bar, cm 60.

CR



A2480
 Maniglione vasca con portasapone.
Bath tub handler with soap holder.

CR



A2496
 Porta sacchetti igienici in ABS.
Tissue holder box in c.p. ABS.

CR



A2490
 Sistema filo stendibiancheria da hotel e di servizio, completo di contenitore, cavo e supporto a muro.
Clothes line sytem for hotel and service use, complete of cable, holder case and wall support.

CR



A2495
 Portasalviettine.
Tissue holder box.

CR



A2495A
 Porta fazzoletti in ABS cromato.
 Dimensioni: 25,5x14x6,5 cm.
*Tissue holder box in c.p. ABS.
 Dimensioni: 25,5x14x6,5 cm.*

CR

VOGUE

WIRE

HILTON

REVIVAL

ACCESSORI
 ACCESSORIES

SISTEMA WC
 WC SYSTEM

SIFONI
 TRAPS

PILETTA
 DRAIN

RUBINETTI SOTTOLAVABO
 ANGLE VALVES

RICAMBI
 SPARE PARTS



A2465

Portascopino in ottone cromato.
Broom rack all in C.P. brass.

CR



A1930

Portascopino in acciaio INOX.
Broom rack in stainless steel.

CR



A1050GR

Dispenser per liquidi, con sistema di chiusura di sicurezza.
Soap dispenser, with security lock system.

CR



A2600

Dispenser per liquidi.
Soap dispenser for liquid.

CR



A1001

Portarifiuti 3 litri.
Toilet bin 3 liters.

CR



A1002

Portarifiuti 5 litri.
Toilet bin 5 liters.

CR



A1003

Portarifiuti 12 litri.
Toilet bin 12 liters.

CR



A1065BI

Doppio dispenser per liquidi con sistema di chiusura di sicurezza, tutto bianco.
Double soap dispenser for liquids, with security lock system, all white.

CR



A2550PS

Piantana con portasciugamani a due posizioni e portascopino.
Vertical towel holder with two arms and with broom rack.

CR



A2635LTP

Specchio ingranditore retroilluminato, accensione al tocco, spegnimento automatico, a batteria. Ø 18 cm, estensione max 34 cm.
Magnifier backlighted mirror, power touch, automatic shutdown, battery powered. Ø 18 cm, maximum extension 34 cm.



CR



A2636LTP

Specchio ingranditore retroilluminato, accensione al tocco, spegnimento automatico, a batteria. 18x18 cm, estensione max 34 cm.
Magnifier backlighted mirror, power touch, automatic shutdown, battery powered. 18x18 cm, maximum extension 34 cm.



CR



A2635LCTP

Specchio ingranditore retroilluminato, con spina e interruttore. Ø 21,5 cm, estensione max 26 cm.
Magnifier backlighted mirror, power supply, and switch. Ø 21,5 cm, maximum extension 26 cm.



CR



A2636LCTP

Specchio ingranditore retroilluminato, con spina e interruttore. 21x21 cm, estensione max 35 cm.
Magnifier backlighted mirror, power supply, and switch. 21x21 cm, maximum extension 35 cm.



CR



A2630

Specchio ingranditore a doppia faccia diametro 15 cm, attacco a muro e braccio snodabile.
Magnifier mirror, double side, diameter 15 cm, wall connection and adjustable arms.

CR



A2635

Specchio ingranditore a doppia faccia diametro 21 cm, attacco a muro e braccio snodabile.
Magnifier mirror, double side, diameter 21 cm, wall connection and adjustable arms.

CR



A2640

Specchio ingranditore a doppia faccia diametro 15 cm.
Magnifier mirror, double side, diameter 15 cm.

CR

VOGUE

WIRE

HILTON

REVIVAL

ACCESSORI
ACCESSORIES

SISTEMA WC
WC SYSTEM

SIFONI
TRAPS

PILETTE
DRAIN

RUBINETTI SOTTOLAVABO
ANGLE VALVES

RICAMBI
SPARE PARTS

SISTEMA WC WC SYSTEM



A1515



A1535

Set composto da: idroscopino a pulsante, flessibile con attacco conico cm 120 metallizzato in PVC, rubinetto ad angolo con vitone ceramico e supporto doccia in ottone, comprensivo di doccetta.

Set including: push-button hydrobrush, 120 cm metallized PVC flexible hose with conical connection, angle tap with ceramic head valve and brass shower holder, including hand shower.

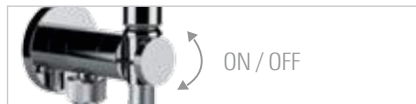

CR



A1545

Set composto da: idroscopino a pulsante, flessibile metallizzato in PVC cm 120 con attacco conico, rubinetto angolare con vitone ceramico e supporto doccia in ottone, comprensivo di doccetta.

Set including: push-button hydrobrush, 120 cm metallized PVC flexible hose with conical connection, corner tap with ceramic head valve and brass "Lux" shower holder, including hand shower.

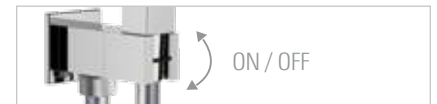

CR



A1515

Set composto da: idroscopino, flessibile conico 120 cm metallizzato in PVC, rubinetto d'arresto minimale, con supporto doccia in ottone cromato e presa acqua.
Set composed of: hydro brush, PVC metallized conical flexible hose 120 cm, c.p. brass minimal angle valve with shower holder and water punch.

CR



A1515C

Set composto da: idroscopino a pulsante, flessibile con attacco conico cm 120 in PVC con piattina cromata, rubinetto d'arresto minimale, con supporto doccia in ottone cromato e presa acqua.
Set composed of: hydro brush handshower, PVC in chrome flat conical flexible hose cm 120, c.p. brass minimal angle valve with shower holder and water punch.

CR



A1525

Set composto da: idroscopino, flessibile conico 120 cm metallizzato in PVC, rubinetto d'arresto squadrato, con supporto doccia in ottone cromato e presa acqua per flessibile con attacco conico.
Set, composed by: hydro brush, PVC metallized conical flexible hose 120 cm, c.p. brass squared angle valve with shower holder and water punch.

CR



A1525C

Set composto da: idroscopino a pulsante, flessibile con attacco conico cm 120 in PVC con piattina cromata, rubinetto d'arresto squadrato, con supporto doccia in ottone cromato e presa acqua per flessibile con attacco conico.
Set composed of: hydro brush handshower, PVC in chrome flat conical flexible hose cm 120, c.p. brass squared angle valve with shower holder and water punch.

CR



A1515TEM

Set composto da: idroscopino a pulsante in ottone cromato, flessibile conico cm 120, rubinetto temporizzato 1/2" in ottone cromato, tempo d'apertura 6-8 secondi.
Set composed by: hydro brush in c.p. brass, flexible cm 120, tempORIZED button flusher 1/2" all in c.p. brass, opening time 6-8 seconds.

CR



SSA2830GE

Placca di comando in acciaio inox spazzolato per cassetta di scarico WC da incasso, adatta per Geberit Sigma8/12.
Brushed stainless steel flush plate for concealed cistern, suitable for Geberit Sigma8/12.

CR



A1515DC

Idroscopino a pulsante in ottone cromato, con impugnatura liscia 1/2".
C.P. brass hydro brush with plain handgrip, 1/2".

CR



A1525DC

Idroscopino a pulsante quadrata, in ottone cromato, 1/2".
C.P. brass hydro brush, squared, 1/2".

CR

SIFONI TRAPS

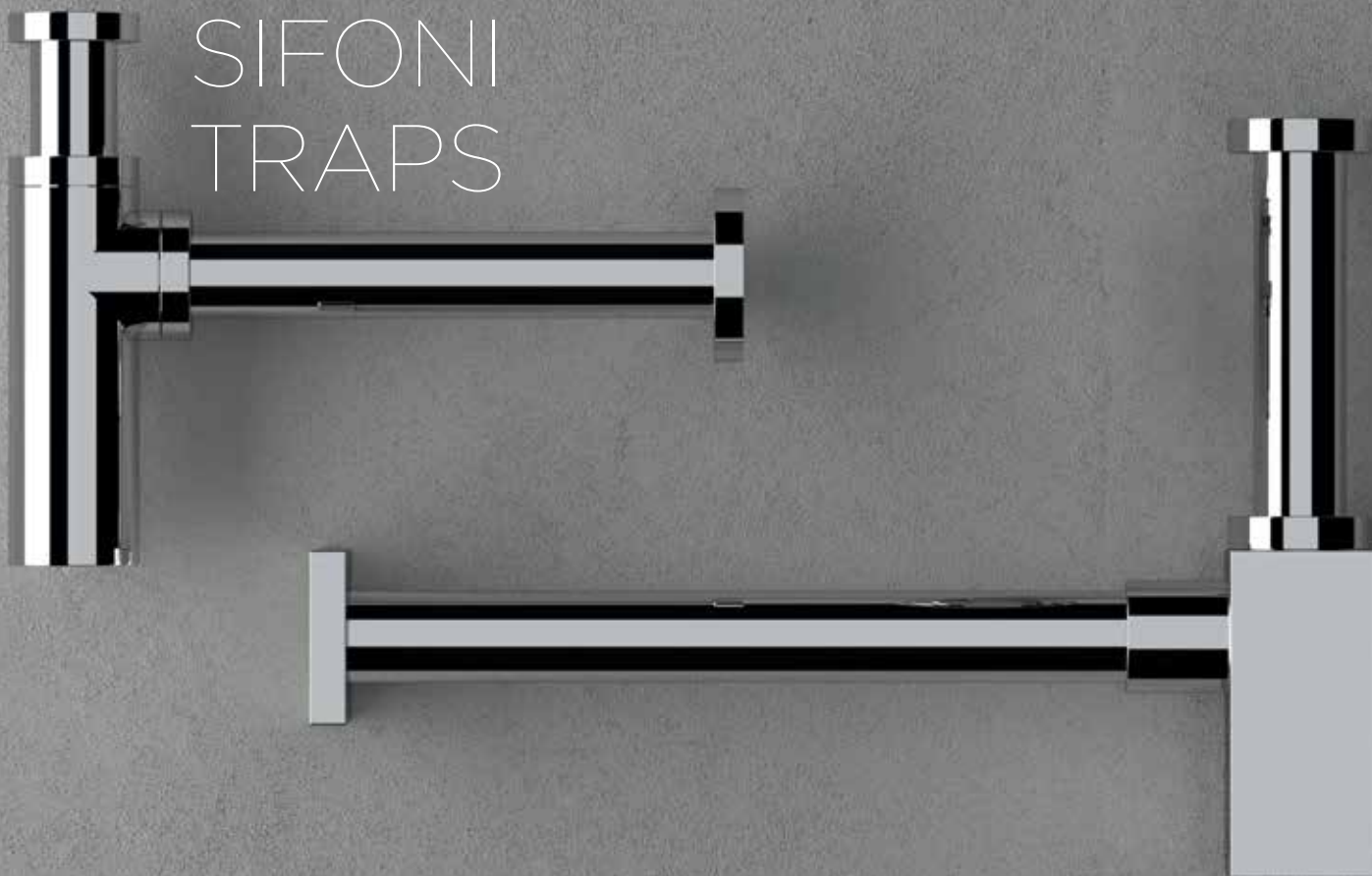

A750114 - A740114

— SIFONI - TRAPS —



A750114

Sifone minimale in ottone cromato 1"1/4.
C.P. brass minimal P trap 1"1/4.



A755114

Sifone "Minimal" in ottone cromato per bidet.
C.P. brass "Minimal" P trap for bidet.



A740114

Sifone squadrato in ottone cromato 1"1/4.
C.P. brass "Square" P trap 1"1/4.



A758114

Sifone in ottone cromato 1"1/4.
C.P. brass P trap 1"1/4.

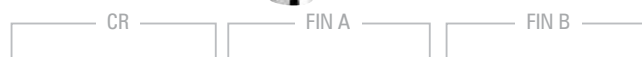

A766Z114

Sifone a S, canotto cm 25 in zama, 1" 1/4.
S trap 25 cm outlet tube in zama, 1"1/4.





Sifone ad U per lavabo a colonna in ottone cromato, canotto cm 25.
Cp brass U trap 25cm outlet tube.

A767CR1

1"

CR FIN A FIN B

A767CR114

1"1/4

CR FIN A FIN B



Sifone fuso pesante lusso in ottone cromato per lavabo e bidet.
C.P. brass luxury P trap heavy type, for wash basin and bidet.

A760CR1

1"

CR FIN A FIN B

A760CR114

1"1/4

CR FIN A FIN B



A765ZCR114

Sifone a bottiglia, canotto cm 25 in zama, 1"1/4.
Bottle trap, 25 cm outlet tube in zama, 1"1/4.

CR



A765P114

Sifone a bottiglia, canotto cm 25 in plastica, 1"1/4.
Bottle trap, 25 cm outlet tube in plastic, 1"1/4.

CR



A766CR114

Sifone a S, canotto cm 25 in ottone cromato, 1"1/4.
S trap 25 cm outlet tube in Cp brass, 1"1/4.

CR FIN A FIN B



A765CR114

Sifone a bottiglia, canotto cm 25 in ottone cromato, 1"1/4.
Bottle trap, 25 cm outlet tube in c.p. brass, 1"1/4.

CR FIN A FIN B



A785114

Sifone salvaspazio con piletta click-clack incorporata, rotondo, cromato. Con troppo pieno.
Space-saving siphon with click-clack built-in drain, round, chrome. With overflow.

CR FIN A FIN B

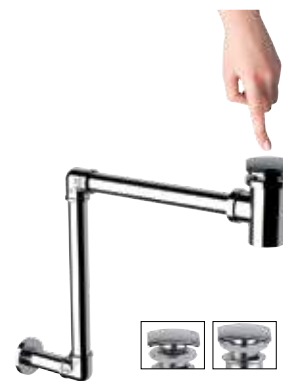

A787114

Sifone salvaspazio con piletta click-clack incorporata, quadrata, cromato. Con troppo pieno.
Space-saving siphon with click-clack built-in drain, squared, chrome. With overflow.

CR FIN A FIN B

A786114

Sifone salvaspazio con piletta click-clack incorporata, rotondo, cromato. Senza troppo pieno.
Space-saving siphon with click-clack built-in drain, round, chrome. Without overflow.

CR FIN A FIN B

A788114

Sifone salvaspazio con piletta click-clack incorporata, quadrata, cromato. Senza troppo pieno.
Space-saving siphon with click-clack built-in drain, squared, chrome. Without overflow.

CR FIN A FIN B

VOGUE

WIRE

HILTON

REVIVAL

ACCESSORI
ACCESSORIES

SISTEMA WC
WC SYSTEM

SIFONI
TRAPS

PILETTE
DRAIN

RUBINETTI SOTTOLAVABO
ANGLE VALVES

RICAMBI
SPARE PARTS

SCARICHI - WASTES



A780

Sifone pesante in ottone fuso con dado 1"1/2 per colonna vasca.
Heavy trap in casting brass, with nut 1"1/2 for bath waste.

CR



A780PL

Sifone in plastica per vasca, 1"1/2 x 40.
Siphon for bathtub in white P.P., 1"1/2 x 40.

CR



A715CR

Colonna di scarico in plastica con piletta "click clack".
Plastic bath waste and overflow with "click clack" waste.

CR



A710CR

Colonna di scarico automatica in plastica con filo esterno, senza dado e codulo.
Plastic combined bath waste with automatic pop-up with external wire.

CR



A700CR

Colonna di scarico automatica con filo esterno e tubo in rame senza dado e codulo.
C.P. brass automatic bath waste and overflow with external wire and copper tube.

CR



A700VA

Colonna di scarico automatico con filo esterno e tubo in rame cm 70, per vasca ad angolo.
C.P. brass automatic bath waste, overflow and copper tube, cm 70, for bath tube edge.

CR



A705CR

Colonna di scarico automatica con piletta "click clack".
C.P. brass bath waste and overflow with "click clack" waste.

CR



Piletta per doccia con piastra cromata.
Waste for shower tray, with chrome plated.

A91190

Ø 90, con uscita scarico Ø mm 40, per piatto doccia con foro Ø 60 mm.
Ø 90, outlet pipe Ø mm 40, for shower tray with hole Ø 60 mm.

CR

A91120

Ø 120, con uscita scarico Ø mm 50, per piatto doccia con foro Ø 90 mm.
Ø 120, outlet pipe Ø mm 50, for shower tray with hole Ø 90 mm.

CR



A705LIT

Colonna di scarico con sifone per vasca con tubo in rame cromato, tutta cromata.
Bath brass waste with siphon, trap and chromated copper tube, all in chrome plated.

CR



A705LICC

Colonna di scarico con sifone per vasca con tubo in rame cromato e piletta click-clack, tutta cromata.
Bath brass waste with siphon, trap, chromated copper tube and click clack waste, all in chrome plated.

CR

PILETTE DRAIN



A732C - A734



Scarico automatico 1", 1"1/4.
C.P. brass pop-up waste 1", 1"1/4.

A900CR1

1"

A900CR114

1"1/4



A902CR114

Scarico automatico da 1"1/4, tipo lusso lucidato, con tappo grande a copertura totale della piletta.

C.P. polished pop-up waste, 1"1/4, luxury type with big plug covering the drain.



A900E

Scarico automatico, 1"1/4.
C.P. brass pop-up waste 1"1/4.



A901CR114

Scarico automatico, tipo lusso lucidato, 1"1/4.
C.p. polished pop-up waste, luxury type, 1"1/4.

A900PL

Scarico automatico in plastica, 1"1/4
Plastic pop-up waste, 1"1/4



CR

A902S

Scarico automatico da 1"1/4, tipo lusso lucidato, con tappo grande quadrato piatto a copertura totale della pileta.
C.p. polished pop-up waste, 1" 1/4, luxury type with big squared flat plug covering the drain.



CR

A900TAS

Tappo grande quadrato in ottone cromato per scarico automatico con pileta da 1"1/4.
Squared big plug in c.p. brass for pop-up waste with drain 1"1/4.



CR

A902TA114

Tappo grande in ottone cromato per scarico automatico con pileta da 1"1/4.
Big plug in c.p. brass for the pop-up waste with drain 1"1/4.



CR

A900AM

Scarico tipo Americano, in ottone pulito e cromato.
C.p. waste model American, polished and in c.p. brass.



CR

A900TA1

1" CR

A900TA114

1"1/4 CR

Tappo scarico automatico per pileta 1" , 1"1/4.
Plug for pop-up waste for drain 1" , 1"1/4.



SCARICHI CLICK-CLACK - CLICK-CLACK WASTES



A732

Scarico automatico con sistema click-clack, 1"1/4, con troppo pieno.
Automatic pop-waste, click-clack system, 1"1/4, with overflow.

CR FIN A FIN B



A732C

Scarico automatico con sistema click-clack, 1"1/4, con troppo pieno, modello con bicchiere corto.
Automatic pop-waste, click-clack system, 1"1/4, with overflow, model with shorter cup.

CR FIN A FIN B



A734

Scarico automatico 1"1/4 con tappo grande sempre aperto e sistema click-clack per la pulizia interna.
Automatic pop-up waste 1"1/4 with big plug always opened, and click-clack system for internal cleaning.

CR FIN A FIN B



A734C

Scarico automatico 1"1/4 con tappo grande sempre aperto e sistema click-clack per la pulizia interna, modello con bicchiere corto.
Automatic pop-up waste 1"1/4 with big plug always opened, and click-clack system for internal cleaning, model with shorter cup.

CR FIN A FIN B



A735

Scarico automatico con sistema click-clack, 1"1/4, e tappo grande, con troppo pieno.
Automatic pop-waste, click-clack system, 1"1/4, big plug, with overflow.

CR FIN A FIN B



A735C

Scarico automatico con sistema click-clack, 1"1/4, e tappo grande, con troppo pieno, modello con bicchiere corto.
Automatic pop-waste, click-clack system, 1"1/4, big plug, with overflow., model with shorter cup.

CR FIN A FIN B



A736

Scarico automatico con sistema click-clack, 1"1/4, e tappo grande, senza troppo pieno.
Automatic pop-waste, click-clack system, 1"1/4, big plug, without overflow.

CR FIN A FIN B



A736C

Scarico automatico con sistema click-clack, 1"1/4, e tappo grande, senza troppo pieno, modello con bicchiere corto.
Automatic pop-waste, click-clack system, 1"1/4, big plug, without overflow, model with shorter cup.

CR FIN A FIN B



A737

Scarico automatico quadrato 1"1/4 con Click-clack con troppo pieno.
Squared automatic pop-up waste 1"1/4 with Click clack system with overflow.

CR FIN A FIN B



A737C

Scarico automatico quadrato 1"1/4 con click-clack con troppo pieno, modello con bicchiere corto.
Squared automatic pop-up waste 1"1/4 with click-clack system with overflow, model with shorter cup.

CR FIN A FIN B



A738

Scarico automatico quadrato 1"1/4 con Click-clack senza troppo pieno.
Squared automatic pop-up waste 1"1/4 with Click clack system without overflow.

CR FIN A FIN B



A738C

Scarico automatico quadrato 1"1/4 con click-clack senza troppo pieno, modello con bicchiere corto.
Squared automatic pop-up waste 1"1/4 with click-clack system without overflow, model with shorter cup.

CR FIN A FIN B



A735R

Scarico automatico universale con chiusura click-clack da 1"1/4.
Universal automatic pop-up waste 1"1/4 with click-clack system.

CR FIN A FIN B



A735XL

Scarico automatico universale con chiusura click-clack da 1"1/4, tappo grande, con troppo pieno, versione extralunga.
Universal automatic pop-up waste 1"1/4 with click-clack system.

CR FIN A FIN B



A905

Astina con pomolo e snodino per serie Eco.
Rod with knob and small joint for Eco series.

CR



A906

Astina con pomolo e snodino.
Rod with knob and small joint.

CR



A900AS30

Astina per scarico automatico, lunghezza cm 30, in ottone cromato.
Rod for automatic waste, length cm 30, in c.p. brass.

CR



A980L

Tubo liscio Ø 10 in rame cromato con attacco filettato 10Mx1 lunghezza cm 40 e dado.
Cp copper pipe Ø 10 mm threaded 10Mx1 length cm 40 and nut.

CR

RUBINETTI SOTTOLAVABO ANGLE VALVES



A60512X38 - A601CR12X38 - A600CR12X38

RUBINETTI SOTTOLAVABO - ANGLE VALVES



Rubinetto sottolavabo con maniglia a leva.
C.P. angle valve with lever handle.

A600CR12X38

1/2x3/8

CR

A600CR12X12

1/2x1/2

CR

A600CR12X10

1/2x10

CR



Rubinetto sottolavabo quadrato con vitone
ceramico.
Angle valve squared with ceramic head valve.

A601CR12X38

1/2x3/8

CR

A601CR12X12

1/2x1/2

CR

A601CR12X10

1/2x10

CR



Rubinetto sottolavabo esagonale con
vitone ceramico.
*Angle valve hexagonal with ceramic head
valve.*

A602CR12X38

1/2x3/8

CR

A602CR12X12

1/2x1/2

CR

A602CR12X10

1/2x10

CR



Rubinetto sottolavabo con filtro e rosetta
in ottone cromato.
C.P. angle valve with filter and flange.

A60512X38

1/2x3/8

CR

A60512X12

1/2x1/2

CR

A60512X34

1/2x3/4

CR

A60512X10

1/2x10

CR



Rubinetto sottolavabo con filtro e snodo, con rosetta in ottone cromato.
C.P. angle valve with filter, ball joint and flange.

A610

1/2x10

CR



Rubinetto sottolavabo a vitone con filtro e snodo, con rosetta in ottone cromato.
C.P. brass angle valve with filter, balljoint and c.p. brass flange.

A61212X10

1/2x10

CR



Rubinetto a sfera con guarnizione in PTFE e rosetta.
C.P. brass ball valve with PTFE washer and flange.

A60612X38

1/2x3/8

CR

A60612X12

1/2x1/2

CR



Rubinetto sottolavabo con filtro e rosetta in ottone cromato.
C.P. angle valve with filter and flange.

A62012X38

1/2x3/8

CR

A62012X12

1/2x1/2

CR

A62012X10

1/2x10

CR



Rubinetto sottolavabo con rosetta.
C.p. angle valve with wall flange.

A61112X38

1/2x3/8

CR

A61112X12

1/2x1/2

CR



Rubinetto sottolavabo lusso con rosetta.
Luxury c.p. angle valve with wall flange.

A611L12X38

1/2x3/8

CR

A611L12X12

1/2x1/2

CR



Curvetta sottolavabo 1/2x10 con rosetta in ottone cromato.
C.P. elbow connection for washbasin with flange 1/2x10.

A625CR

1/2x10

CR

VOGUE
WIREF
HILTON
REVIVAL
ACCESSORI
ACCESSORIES
SISTEMA WC
WC SYSTEM
SIFONI
TRAPS
PILETTE
DRAIN
RUBINETTI SOTTOLAVABO
ANGLE VALVES
RICAMBI
SPARE PARTS

RUBINETTI LAVATRICE - WASHING MACHINE TAPS



Rubinetto a tre vie sottolavabo per attacco lavatrice.
C.P. three ways washing machine bibcock, brass model.

A645

1/2x3/4

CR



Deviatore doccia per canna livello Ø18 mm.
C.P. diverter for shower, for sink spout Ø18 mm.

A650

3/4Mx3/4Fx1/2M

CR



Rubinetto a sfera per lavatrice, maniglia a farfalla con rosetta in ottone cromato.
C.P. hose bibcock for washing machine, with flange.

A66012X12

1/2x1/2

CR

A66038X34

3/8x3/4

CR

A66012X34

1/2x3/4

CR



Rubinetto a sfera con valvola di non ritorno con rosetta ottone cromato.
CP Hose bibcock for washing machine with flange in Cp brass with no-return valve.

A660NR

1/2x3/4

CR



Rubinetto sottolavabo con rosetta.
C.p. brass angle valve with flange.

A67512X38

1/2x3/8

CR

A67512X12

1/2x1/2

CR

A67512X10

1/2x10

CR



Rubinetto portagomma a sfera, maniglia a leva e cromato.
Cp ball bibcock, Hose-end with lever handle.

A690

1/2

CR



Distanziatore per gruppi.
C.P. brass connection for mixers.

A640RA

3/4x3/4

CR



Distanziatore per gruppi con rubinetto lavatrice.
C.P. washing machine bibcock with connection.

A640

3/4x3/4x3/4

CR



Rubinetto combinato 1/2 sottolavabo e 3/4 attacco lavatrice.
Union valve 1/2 with under sink coupling and 3/4 connection for washing machine.

A615

1/2x3/4

CR

PASSO RAPIDO E RUBINETTI DA GIARDINO - FLUSHING VALVE AND GARDEN TAPS



Rubinetto portagomma a sfera tipo pesante maniglia a leva cromato.
Brass ball bibcock, Heavy Type, hose-end with lever handle.

A69112

1/2

CR

A69134

3/4

CR



Rubinetto portagomma in ottone tipo pesante.
Hose end bibcock in brass heavy type.

A692

1/2

CR

A69234

3/4

CR



A695

Rubinetto curvo da giardino in ottone giallo trattato, 1/2 a maniglia, con rosetta pesante aeratore e riduzione 3/4 per portagomma.

Plain-end garden bibcock, heavy duty in treated yellow brass, 1/2 traditional handle, with heavy flange, aerator and 3/4 reduction for hose connection.



CR



A696

Rubinetto curvo da giardino in ottone giallo trattato, 1/2 a leva, con rosetta pesante aeratore e riduzione 3/4 per portagomma.

Plain-end garden bibcock, heavy duty in treated yellow brass, 1/2 lever type, with heavy flange, aerator and 3/4 reduction for hose connection.



CR



Passo rapido ad incasso con ritorno automatico.
Built-in flushing valve with automatic return.

A17134CR

3/4

CR

A1711CR

1"

CR

VOGUE
 WIRE
 HILTON
 REVIVAL
 ACCESSORI
 ACCESSORIES
 SISTEMA WC
 WC SYSTEM
 SIFONI
 TRAPS
 PILETTE
 DRAIN
RUBINETTI SOTTOLAVABO
ANGLE VALVES
 RICAMBI
 SPARE PARTS

RICAMBI SPARE PARTS



CARTUCCE E FISAGGI - CARTRIDGES FIXING SET



A846

Cartuccia Ø25 mm
(tipo aperto).
*Ceramic cartridge Ø25 mm
(opened type).*

CR



A846C

Cartuccia Ø25 mm
(tipo chiuso).
*Ceramic cartridge Ø25 mm
(closed type).*

CR



A810

Cartuccia Ø40 mm a dischi
di ceramica (tipo con
distributore).
*Ceramic cartridge Ø40 mm
(type with distributor).*

CR



A820

Cartuccia Ø35 mm a dischi
di ceramica (tipo con
distributore).
*Ceramic cartridge Ø35 mm
(type with distributor).*

CR



A815

Cartuccia Ø40 mm a dischi di
ceramica (tipo piatto).
*Ceramic cartridge Ø40 mm
(flat bottom type).*

CR



A825

Cartuccia Ø35 mm a dischi di
ceramica (tipo piatto).
*Ceramic cartridge Ø35 mm
(flat bottom type).*

CR



A830

Cartuccia Ø35 mm modello "joystick" (tipo con distributore).

Cartridge Ø35 mm type "joystick" (type with distributor).

CR



A835

Cartuccia Ø35 mm modello "joystick" (tipo piatto).

Cartridge Ø35 mm type "joystick" (flat bottom type).

CR



A840

Cartuccia Ø40 mm modello "joystick" (tipo con distributore).

Cartridge Ø40 mm type "joystick" (type with distributor).

CR



A845

Cartuccia Ø25 mm per Serie Oxy.

Cartridge Ø25 mm for Serie Oxy.

CR



A821

Cartuccia Ø35 mm a dischi ceramici per lavello, doccia, vasca, bidet (tipo piatto).

Ceramic cartridge Ø35 mm for sink, shower, bath, bidet (flat bottom type).

CR



A820TH

Cartuccia termostatica con apertura del flusso per serie X-Factor.

Thermostatic cartridge with flow opening, for X-Factor serie.

CR



A815TH

Cartuccia termostatica coassiale.

Thermostatic coaxial cartridge.

CR



A846T

Cartuccia Ø25 a dischi in ceramica tipo piatto con asta in plastica.

Ceramic cartridge Ø25 flat bottom type with rod in plastic.

CR



A847

Cartuccia Ø25 immersa con asta in plastica.

Ceramic cartridge Ø25 with plastic rod.

CR



FISOM618

Set di fissaggio per miscelatore lavello Omega OM618.

Fixing set for Omega OM618 sink mixer.

CR



FISSK605

Set di fissaggio per miscelatori lavabo/bidet Skyline.

Fixing set for Skyline basin/bidet mixers.

CR



FISSR605

Set di fissaggio per miscelatori lavabo/bidet Smart.

Fixing set for Smart basin/bidet mixers.

CR

VITONI E DEVIATORI - HEADVALVES AND DIVERTERS



A850DX

Vitone 180° a dischi ceramici, broccia Ø8 mm, destro.
Head valve 180° ceramic disks, broach Ø8 mm, right.

CR



A850SX

Vitone 180° a dischi ceramici, broccia Ø8 mm, sinistro.
Head valve 180° ceramic disks, broach Ø8 mm, left.

CR



A850DX90

Vitone 90° a dischi ceramici, broccia Ø8 mm, destro
Head valve 90° ceramic disks, broach Ø8 mm, right.

CR



A850SX90

Vitone 90° a dischi ceramici, broccia Ø8 mm, sinistro.
Head valve 90° ceramic disks, broach Ø8 mm, left.

CR



A852DX

Vitone 90° a dischi ceramici, broccia Ø8 mm, destro, per Serie Twin.
Head valve 90° ceramic disks, broach Ø8 mm, right, for Twin Serie.

CR



A852SX

Vitone 90° a dischi ceramici, broccia Ø8 mm, sinistro, per Serie Twin.
Head valve 90° ceramic disks, broach Ø8 mm, left, for Twin Serie.

CR



A850THP

Cartuccia termostatica con rotazione manopola a 330° angolari, blocco di sicurezza a 38°C, campo di lavoro da 5°C a 80°C, campo di pressione da 1 a 10 bar, filtro inox e sistema di sicurezza con blocco dell'erogazione in caso di mancanza di una delle due acque, realizzato con materiali termoplastici ad elevata robustezza.
Thermostatic cartridge with 330° angular handle rotation, 38° safety lock, working field from 5°C to 80°C, pressure field from 1 to 10 bar, stainless steel filter and safety system with the outlet lock in case there is one water lock, high performance thermoplastic materials.

CR



A851

Vitone normale broccia 8x20.
Head valve broach 8x20.

CR



A870DE

Deviatore in ottone, automatico, con molla e fermo per basse pressioni.
Automatic brass diverter with spring and lock for low pressure.

CR



A853DX

Vitone 90° a dischi ceramici con asta lunga per 3 fori Revival.
Head valve 90° ceramic disks with long rod for 3-holes Revival.

CR

PROLUNGHE PER MISCELATORE DOCCIA INCASSO
EXTENSIONS FOR BUILT-IN SHOWER MIXER



DEV612

Deviatore in ottone per miscelatori doccia incasso, pomolo tondo, automatico, con molla.

Automatic brass diverter for built-in shower mixers, with round knob and spring.

CR



E5612PROL

Prolunga per corpo monocomando doccia incasso con deviatore per cartuccia Ø 40 mm o termostatica.

Extension for built-in shower mixer body with diverter for cartridge Ø 40 mm or thermostatic.

CR



DV612PROL

Prolunga per corpo monocomando doccia incasso con deviatore per cartuccia Ø 35 mm.

Extension for built-in shower mixer body with diverter for cartridge Ø 35 mm.

CR



A815PROL

Prolunga per corpo monocomando doccia incasso per cartuccia Ø 40 mm.

Extension for built-in shower mixer body for cartridge Ø 40 mm.

CR



A825PROL

Prolunga per corpo monocomando doccia incasso per cartuccia Ø 35 mm.

Extension for built-in shower mixer body for cartridge Ø 35 mm.

CR

VOGUE
WIRE
HILTON
REVIVAL
ACCESSORI
ACCESSORIES
SISTEMA WC
WC SYSTEM
SIFONI
TRAPS
PILETTA
DRAIN
RUBINETTI SOTTOLAVABO
ANGLE VALVES
RICAMBI
SPARE PARTS

PROLUNGHE PER MISCELATORE LAVABO INCASSO
EXTENSION FOR BUILT-IN BASIN MIXER



TK632PROL

Prolunga per lavabo incasso. Anche in versione "Box Incasso". Cartuccia Ø25.
Extension for built-in basin mixer. Also available in "Built-in Box" version. Ø25 cartridge.

CR



DV632PROL

Prolunga per lavabo incasso. Anche in versione "Box Incasso". Cartuccia Ø25.
Extension for built-in basin mixer. Also available in "Built-in Box" version. Ø25 cartridge.

CR



S20632PROL

Prolunga per lavabo incasso. Anche in versione "Box Incasso". Cartuccia Ø35.
Extension for built-in basin mixer. Also available in "Built-in Box" version. Ø35 cartridge.

CR



SR632PROL

Prolunga per lavabo incasso. Anche in versione "Box Incasso". Cartuccia Ø35.
Extension for built-in basin mixer. Also available in "Built-in Box" version. Ø35 cartridge.

CR



FU632PROL

Prolunga per lavabo incasso. Anche in versione "Box Incasso". Cartuccia Ø35.
Extension for built-in basin mixer. Also available in "Built-in Box" version. Ø35 cartridge.

CR

— CANNE - SPOUTS —



A860S

Canna lavello inferiore "S" con aeratore.
Lower "S" sink spout with aerator.



A861D

Canna fusa lunga cm 30 con deviatore, con calotta da 3/4 ed aeratore.
Casted cm 30 long spout with diverter, with 3/4 nut, with aerator.



A860U

Canna lavello superiore a "U" con aeratore.
Upper "U" sink spout with aerator.



A862T

Canna a biscotto a "C" con calotta da 3/4, con aeratore.
"C" spout with nut 3/4, with aerator.

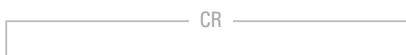

A862TC

Canna a biscotto a "C" con calotta da 3/4, con aeratore, tipo corto.
"C" spout with nut 3/4, with aerator, short type.

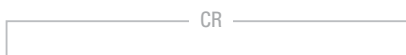

A861F

Canna fusa per lavello con aeratore.
Sink casted spout with aerator.



Canna a biscotto diritta, calotta da 3/4, con aeratore.
Straight spout with 3/4 nut, with aerator.

A862TDCM16

16 cm



A862TDCM20

20 cm



A862TDCM30

30 cm



A862TDCM40

40 cm



A862TDCM50

50 cm



Canna a biscotto ad "S", calotta da 3/4, con aeratore.
"S" spout with 3/4 nut, with aerator.

A862SCM16

16 cm



A862SCM20

20 cm



A862SCM30

30 cm



VOGUE

WIRE

HILTON

REVIVAL

ACCESSORI
ACCESSORIES

SISTEMA WC
WC SYSTEM

SIFONI
TRAPS

PILETTE
DRAIN

RUBINETTI SOTTOLAVABO
ANGLE VALVES

RICAMBI
SPARE PARTS

COMPLEMENTI - COMPLEMENTS



A861FC

Canna fusa a "C" con calotta da 3/4, con aeratore, tipo corto.
Casted "C" spout with nut 3/4, with aerator, short type.

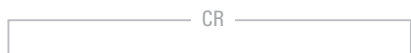

A862U

Canna a "U" Ø 22, con aeratore.
"U" spout Ø 22, with aerator.



A860J

Canna fusa per lavello con aeratore.
Sink casted spout with aerator.



A862P

Canna girevole per lavello, con aeratore.
Swivelling spout for sink, with aerator.



A698CNM

Bocca alta minimale.
High minimal spout.



A698CNQ

Bocca alta quadrata.
High squared spout.



DOCCETTE - HAND SHOWERS



Doccetta estraibile cromata per monoforo lavello, 2 funzioni.
Pull-out hand shower for one-hole sink mixer, 2 functions.

A413

Senza scatola - Without box



A413S

Con scatola - With box





A803EU

Aeratore Neoperl M24 coin slot. Installazione e rimozione dell'aeratore utilizzando una moneta inserita nell'apposita fessura.
Neoperl aerator M24 coin slot. Installation and removal of the aerator by using a coin placed in the slot.

CR



A803NEBA

Aeratore Neoperl M24X1 con getto direzionabile tramite terminale basculante, permette con il semplice tocco della parte inferiore dell'aeratore di dirigere il flusso nella direzione desiderata.
Neoperl aerator M24X1 with movable aerator bottom that, with the simple touch, permits to move the flow to the preferred direction.

CR



A803CA165

Aeratore a scomparsa M16,5x1 (da utilizzare con chiave A803KEYCA165)
Hidden aerator M16,5x1 (to be used with A803KEYCA165 key).

CR



A803KEYCA165

Chiave per la sostituzione e la pulizia degli aeratori a scomparsa M16,5 (vedi modello A803CA165).
Key for replacement and cleaning of M16,5 hidden aerators (see item A803CA165).

CR



A803CA185

Aeratore a scomparsa M18,5x1 (da utilizzare con chiave A803KEYCA185)
Hidden aerator M18,5x1 (to be used with A803KEYCA185 key).

CR



A803KEYCA185

Chiave per la sostituzione e la pulizia degli aeratori a scomparsa M18,5 (vedi modello A803CA185).
Key for replacement and cleaning of M18,5 hidden aerators (see item A803CA185).

CR



A803NE

Aeratore M24X1 con effetto a scomparsa, tecnologia in silicone autopulente per una pulizia veloce dal calcare. Indicato per miscelatori per lavabo di design, è utilizzabile su tutti i miscelatori con filetto M24 (da utilizzare con chiave A803KEYFLBA)
M24X1 aerator with hidden effect, self-cleaning silicone technology for quick cleaning from limescale. Suitable for design wash-basin mixers, can be installed on all mixer models with M24 thread (to be used with A803KEYFLBA key)

CR



A803FLBA

Aeratore ultrapiatto M24 basculante per regolare l'inclinazione del flusso (da utilizzare con chiave A803KEYFLBA).
Ultra-flat aerator M24 with tilting plate for adjustable stream angle (to be used with A803KEYFLBA key).

CR



A803KEYFLBA

Chiave per la sostituzione e la pulizia degli aeratori ultrapiatti M24 (vedi modelli A803FLBA, A803EU, A803NE).
Key for replacement and cleaning of M24 ultra-flat aerators (see items A803FLBA, A803EU, A803NE).

CR



A803

Aeratore per lavabo, lavello e bidet M24.
Aerator for washbasin, sink and bidet mixer M24.

CR



A803CR18

Aeratore serie Diva, M18x1.
Diva aerator, M18x1.

CR



A801CR16

Aeratore F16x1.
Aerator F16x1.

CR



A801

Aeratore per gruppo livello F22.
Aerator for sink spout F22.

CR



A801KC

Aeratore F22x1.
Aerator F22x1.

CR



A804

Aeratore per gruppi vasca M28.
Aerator for bath mixer M28.

CR



A805

Aeratore con snodo per monoforo bidet M24.
Ball joint aerator for bidet mixer M24.

CR



A803KIT1

Set completo di 3 aeratori anticalcare M24 ad alta tecnologia + 1 chiave per la pulizia settimanale, brevettati e di lunghissima durata, il tutto in ottone cromato e materiale plastico innovativo a forte resistenza, confezionato in un tubo contenitore rigido e trasparente adatto per essere appeso. La chiave è stata studiata per pulire il calcare dall'aeratore in un solo semplice movimento.
Set complete of 3 anti-limestone M24 aerators of high technology + 1 weekly cleaning key, patented and extremely long lasting, all in c.p. brass and innovative plastic material very resistant, packed in a holding hard and transparent tube, suitable to be hang. The key has been studied to clean the aerator in one simple, easy movement.

CR



A803KIT2

Set completo di 2 aeratori anticalcare M24 e 1 aeratore anticalcare F22 + 1 chiave per la pulizia settimanale, brevettati e di lunghissima durata, il tutto in ottone cromato e materiale plastico innovativo a forte resistenza, confezionato in un tubo contenitore rigido e trasparente adatto per essere appeso. La chiave è stata studiata per pulire il calcare dall'aeratore in un solo semplice movimento.
Set complete of 2 anti-limestone M24 aerators and 1 anti-limestone F22 aerator + 1 weekly cleaning key, patented and extremely long lasting, all in c.p. brass and innovative plastic material very resistant, packed in a holding hard and transparent tube, suitable to be hang. The key has been studied to clean the aerator in one simple, easy movement.

CR



A801K

Set completo di 1 aeratore F22 anticalcare ad alta tecnologia + 1 chiave di pulizia settimanale, brevettati e di lunghissima durata, il tutto in ottone cromato e materiale plastico innovativo a forte resistenza. L'aeratore e la chiave sono stati studiati per pulire il calcare dall'aeratore in un solo semplice movimento.
Set complete of 1 anti-limestone F22 aerator of high technology + 1 weekly cleaning key, Patented and extremely long lasting, all in c.p. brass and innovative plastic material very resistant. The aerator and the key has been studied to clean the aerator in one simple, easy movement.

CR



A803K

Set completo di 1 aeratore M24 anticalcare ad alta tecnologia + 1 chiave di pulizia settimanale, brevettati e di lunghissima durata, il tutto in ottone cromato e materiale plastico innovativo a forte resistenza. L'aeratore e la chiave sono stati studiati per pulire il calcare dall'aeratore in un solo semplice movimento.
Set complete of 1 anti-limestone M24 aerator of high technology + 1 weekly cleaning key, Patented and extremely long lasting, all in c.p. brass and innovative plastic material very resistant. The aerator and the key has been studied to clean the aerator in one simple, easy movement.

CR



A803AV

Kit antivandalico e anticalcare composto da aeratore speciale per miscelatori lavabo e bidet M24 e chiave di montaggio, manutenzione e pulizia settimanale, ad alta tecnologia, brevettata.

Anti-vandalism and anti-limestone kit, composed by special aerator for wash basin and bidet mixers M24 and assembly, caring and weekly cleaning key, high technology and patented.

CR

LINEA RISPARMIO IDRICO WATER ENERGY SAVING LINE



Kit antivandalico e anticalcare composto da aeratore speciale per miscelatori lavabo e bidet M24 e chiave di montaggio, manutenzione e pulizia settimanale, ad alta tecnologia, brevettata.

Anti-vandalism and anti-limestone kit, composed by special aerator for wash basin and bidet mixers M24 and assembly, caring and weekly cleaning key, high technology and patented.

A803AVL6

6 lt/min

CR

A803AVL8

8 lt/min

CR



Set risparmio idrico totale composto da raccordo doccia 1/2" in ottone cromato a portata limitata, aeratore lavabo e bidet M24 a portata limitata e chiave di montaggio manutenzione e pulizia settimanale, ad alta tecnologia, brevettata. Il kit è disponibile in varianti da 6 litri al minuto.

Total water saving set, composed by 1/2" shower connection with reduced flow in c.p. brass, wash basin and bidet aerator with reduced flow and assembling, caring and weekly cleaning key, high technology, patented. This set is available with outlet flow of 6 liters by minute.

A803SETL6

6 lt/min

CR

A803SETL8

8 lt/min

CR



A520FI12

Guarnizione da 1/2" con filtro retinato anti-impurità.
1/2" washer with net filter, anti-impurity.

CR



A520RE12

Guarnizione da 1/2" a passaggio ridotto, con risparmio idrico del 30%.
1/2" Washer, reduced flow, water saving 30%.

CR



A803L6

6 lt/min

CR

A803L8

8 lt/min

CR



A520RL6 - A520RL8

Raccordo doccia 1/2" a risparmio idrico con limitatore di portata da 6 litri al minuto (art. A520RL6) o 8 litri al minuto (art. A520RL8).

C.p. brass connection, water saving program with flow reduction at 6 liters by minute (art. A520RL6) or 8 liters by minute (art. A520RL8).

CR

COLONNE VASCA - BATH COLUMNS



A880XL

Coppia colonne da pavimento in ottone cromato, 3/4M x 3/4M.
Couple c.p. brass floor columns for bath mixer 3/4M x 3/4M.

CR



A880XLSU

Coppia colonne vasca in ottone cromato, con supporto doccia, 3/4M x 3/4M.
Couple c.p. brass vertical connections for bath mixer, with hand shower holder 3/4M x 3/4M.

CR

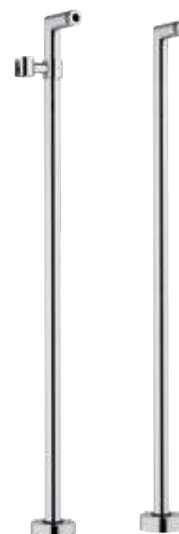

A880XLM

Coppia colonne vasca in ottone cromato, minimale, con supporto doccia, 3/4M x 3/4M.
Couple c.p. brass vertical connections for bath mixer, minimalist, with hand shower holder 3/4M x 3/4M.

CR



A880

Colonnina bordo vasca in ottone cromato 1/2Mx3/4M.
C.P. brass vertical connection for bath mixer 1/2Mx3/4M.

CR



A880UK

Coppia colonnette bordo vasca in ottone cromato, 3/4Mx3/4M.
Couple C.P. brass connections for bath mixer, 3/4Mx3/4M.

CR



A880V

Coppia colonnette bordo vasca in ottone cromato "Revival" 3/4Mx3/4M.
Couple c.p. Brass vertical connection for bath mixer "Revival" 3/4Mx3/4M.

CR



A4491SUP

Supporto per doccetta estraibile per bordo lavello e bordo vasca, modello a base tonda.
Support for extensible handshower for deck bath and deck sink, round base model.

CR



A4491SUPQ

Supporto dritto per doccetta estraibile per bordo lavello e bordo vasca, modello a base quadra.
Straight support for extensible handshower for deck bath and deck sink, squared base model.

CR



A910

Confezione fissa water-bidet composta da 4 viti ottone, 4 dadi ottone, 4 sottoviti, 4 tasselli.
Bag for fixing W/C-bidet: a brass screw, 4 caps, 4 under screws, 4 nuts.

CR

ROSONI - WALL FLANGE



Rosone a muro in ottone cromato.
Standard wall flange in c.p. brass.

A682

Ø 26

CR



Rosone a muro in ottone cromato, Ø est. mm 77.
Standard wall flange in c.p. brass, ext. Ø mm 77.

A68426

Ø 26

CR

A68230

Ø 30

CR

A68430

Ø 30

CR

A68232

Ø 32

CR

A68432

Ø 32

CR

A68440

Ø 40

CR



A683

Rosone a muro quadrato con OR in ottone cromato, per serie quadrate e sifoni misure: Ø 32.

Heavy wall flange with OR in c.p. brass, for squared series and traps Dimensions: Ø 32.

CR



A680

Rosone a muro con OR in ottone cromato per serie minimali Ø 32.

Heavy wall flange for traps in Cp brass, for minimal series Ø 32.

CR



A681

Rosetta pesante in ottone cromato 1/2.
Heavy wall flange in chrome plated brass 1/2.

CR

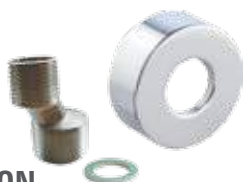

A870RON

Eccentrico per gruppi 1/2 x 3/4, con rosone minimale in ottone cromato, Ø 63.

Eccentric unions for mixers 1/2 x 3/4, with minimal C.P. brass flange, Ø 63.

CR



A870RON70

Eccentrico per gruppi 1/2 x 3/4, con rosone minimale in ottone cromato, Ø 70.

Eccentric unions for mixers 1/2 x 3/4, with minimal C.P. brass flange, Ø 70.

CR



A870RO

Eccentrico per gruppi, tipo lusso con rosone in ottone cromato.

Eccentric union for mixers, luxury type, with c.p. brass flange.

CR



A671

Copriforo per lavabo e bidet Ø50 verniciato bianco tipo pesante.

White hole cover for washbasin and bidet Ø50 heavy type.

CR



A670CR

Tappo copriforo per lavabo e bidet.

Hole cover for washbasin and bidet.

CR

VOGUE

WIRE

HILTON

REVIVAL

ACCESSORI
ACCESSORIES

SISTEMA WC
WC SYSTEM

SIFONI
TRAPS

PILETTE
DRAIN

RUBINETTI SOTTOLAVABO
ANGLE VALVES

RICAMBI
SPARE PARTS

PROLUNGHE - EXTENSIONS



Prolunghe in ottone cromato, con broccia.
C.P. brass extension

A276CR10	1/2 x 10 mm	CR	A27634CR10	3/4 x 10 mm	CR
A276CR15	1/2 x 15 mm	CR	A27634CR15	3/4 x 15 mm	CR
A276CR20	1/2 x 20 mm	CR	A27634CR20	3/4 x 20 mm	CR
A276CR25	1/2 x 25 mm	CR	A27634CR25	3/4 x 25 mm	CR
A276CR30	1/2 x 30 mm	CR	A27634CR30	3/4 x 30 mm	CR
A276CR40	1/2 x 40 mm	CR	A27634CR40	3/4 x 40 mm	CR
A276CR50	1/2 x 50 mm	CR	A27634CR50	3/4 x 50 mm	CR
A276CR60	1/2 x 60 mm	CR	A27634CR60	3/4 x 60 mm	CR
A276CR80	1/2 x 80 mm	CR	A27634CR80	3/4 x 80 mm	CR
A276CR100	1/2 x 100 mm	CR	A27634CR100	3/4 x 100 mm	CR



Prolunghe in ottone cromato, tipo pesante Ø 27 mm, con broccia.
C.P. brass extension Ø 27 mm.



Prolunghe ridotte in ottone cromato.
Reduction piece round in C.P. brass.

A276PCR10	1/2 x 10 mm	CR	A278CR12X38	1/2 x 3/8	CR
A276PCR15	1/2 x 15 mm	CR	A278CR12X34	1/2 x 3/4	CR
A276PCR20	1/2 x 20 mm	CR	A278CR34X10	3/4 x 1"	CR
A276PCR25	1/2 x 25 mm	CR			
A276PCR30	1/2 x 30 mm	CR			
A276PCR40	1/2 x 40 mm	CR			
A276PCR50	1/2 x 50 mm	CR			
A276PCR60	1/2 x 60 mm	CR			
A276PCR80	1/2 x 80 mm	CR			
A276PCR100	1/2 x 100 mm	CR			

TUBI E RACCORDI - PIPES AND NIPPLES



Tubo liscio in rame cromato Ø10 mm, con 2 cartelle e 2 dadi da 1/2, disponibile con dadi 3/8.

C.p. copper pipe Ø mm 10, with 2 nuts 1/2, available with nuts 3/8.

Tubo liscio Ø 10 mm in rame cromato, con cartella e dado da 1/2, disponibile con dado 3/8..

C.p. copper pipe Ø mm 10, with nut 1/2, available with nut 3/8.

A980FF30 1/2Fx1/2F 30 cm CR

A980F30 1/2F x 30 cm CR

A980FF40 1/2Fx1/2F 40 cm CR

A980F35 1/2F x 35 cm CR

A980FF50 1/2Fx1/2F 50 cm CR

A980F40 1/2F x 40 cm CR

A980FF60 1/2Fx1/2F 60 cm CR

A980F50 1/2F x 50 cm CR

A980F60 1/2F x 60 cm CR



Nipples completo con guarnizione in gomma, ranella e anello tagliato in ottone.

C.p. double nipple with nut and 3 pcs washers.

A63038X10 3/8x10 CR

A63012X10 1/2x10 CR

A630L



Nipples prolungato completo con guarnizione in gomma, ranella e anello tagliato in ottone, 1/2 x 10 mm.

Extended c.p. double nipple with nut and 3 pcs washers, 1/2 x 10 mm.

CR

A630D



Doppio nipples completo con guarnizioni in 3 pezzi, 3/8 x 10 x 10 x 10.

C.p. double nipple with nut and 3 pcs washers, 3/8 x 10 x 10.

CR

A630F



Raccordo femmina completo con guarnizioni in 3 pezzi, 1/2 x 10 mm.

C.p. female connection, with nut and 3 pcs washers, 1/2 x 10.

CR



A936M1210

Raccordo a gomito completo con guarnizione in gomma, ranella e anello tagliato in ottone, 1/2 x 10.

C.p. elbow with nut and 3 pcs washers, 1/2 x 10.

CR



A9361010

Raccordo a gomito con guarnizione in gomma, ranella e anelli tagliati in ottone, 10 x 10.

C.p. elbow with two nuts and 3 pcs washers, 10 x 10.

CR



A936T1010

Raccordo a T con guarnizioni in gomma, ranelle e anelli tagliati in ottone, 10 x 10 x 10 mm.

Equal T connection, with 3 nuts and 3 pcs washers, 10 x 10 x 10 mm.

CR

VOGUE

WIRE

HILTON

REVIVAL

ACCESSORI
ACCESSORIES

SISTEMA WC
WC SYSTEM

SIFONI
TRAPS

PILETTE
DRAIN

RUBINETTI SOTTOLAVABO
ANGLE VALVES

RICAMBI
SPARE PARTS

— FLESSIBILI - FLEXIBLE HOSES —

— DN10 —



Flessibile in treccia d'acciaio inox Ø14 DN10 con tubo interno in gomma alimentare.
Flexible hose in stainless steel DN10 Ø14 with internal in EPDM.

1/2Fx1/2F

1/2Fx3/8F

3/8Fx3/8F

A9502012F12F	20 cm	<input type="checkbox"/> CR	A9502012F38F	20 cm	<input type="checkbox"/> CR	A9502038F38F	20 cm	<input type="checkbox"/> CR
A9502512F12F	25 cm	<input type="checkbox"/> CR	A9502512F38F	25 cm	<input type="checkbox"/> CR	A9502538F38F	25 cm	<input type="checkbox"/> CR
A9503012F12F	30 cm	<input type="checkbox"/> CR	A9503012F38F	30 cm	<input type="checkbox"/> CR	A9503038F38F	30 cm	<input type="checkbox"/> CR
A9503512F12F	35 cm	<input type="checkbox"/> CR	A9503512F38F	35 cm	<input type="checkbox"/> CR	A9503538F38F	35 cm	<input type="checkbox"/> CR
A9504012F12F	40 cm	<input type="checkbox"/> CR	A9504012F38F	40 cm	<input type="checkbox"/> CR	A9504038F38F	40 cm	<input type="checkbox"/> CR
A9505012F12F	50 cm	<input type="checkbox"/> CR	A9505012F38F	50 cm	<input type="checkbox"/> CR	A9505038F38F	50 cm	<input type="checkbox"/> CR
A9506012F12F	60 cm	<input type="checkbox"/> CR	A9506012F38F	60 cm	<input type="checkbox"/> CR	A9506038F38F	60 cm	<input type="checkbox"/> CR
A9508012F12F	80 cm	<input type="checkbox"/> CR	A9508012F38F	80 cm	<input type="checkbox"/> CR	A9508038F38F	80 cm	<input type="checkbox"/> CR
A95010012F12F	100 cm	<input type="checkbox"/> CR	A95010012F38F	100 cm	<input type="checkbox"/> CR	A95010038F38F	100 cm	<input type="checkbox"/> CR

— DN10 —



Flessibile in treccia d'acciaio inox Ø14 DN10 con tubo interno in gomma alimentare.
Flexible hose in stainless steel DN10 Ø14 with internal in EPDM.

1/2Mx1/2F

1/2Mx3/8F

3/8Mx3/8F

A9502012M12F	20 cm	<input type="checkbox"/> CR	A9502012M38F	20 cm	<input type="checkbox"/> CR	A9502038M38F	20 cm	<input type="checkbox"/> CR
A9502512M12F	25 cm	<input type="checkbox"/> CR	A9502512M38F	25 cm	<input type="checkbox"/> CR	A9502538M38F	25 cm	<input type="checkbox"/> CR
A9503012M12F	30 cm	<input type="checkbox"/> CR	A9503012M38F	30 cm	<input type="checkbox"/> CR	A9503038M38F	30 cm	<input type="checkbox"/> CR
A9503512M12F	35 cm	<input type="checkbox"/> CR	A9503512M38F	35 cm	<input type="checkbox"/> CR	A9503538M38F	35 cm	<input type="checkbox"/> CR
A9504012M12F	40 cm	<input type="checkbox"/> CR	A9504012M38F	40 cm	<input type="checkbox"/> CR	A9504038M38F	40 cm	<input type="checkbox"/> CR
A9505012M12F	50 cm	<input type="checkbox"/> CR	A9505012M38F	50 cm	<input type="checkbox"/> CR	A9505038M38F	50 cm	<input type="checkbox"/> CR
A9506012M12F	60 cm	<input type="checkbox"/> CR	A9506012M38F	60 cm	<input type="checkbox"/> CR	A9506038M38F	60 cm	<input type="checkbox"/> CR
A9508012M12F	80 cm	<input type="checkbox"/> CR	A9508012M38F	80 cm	<input type="checkbox"/> CR	A9508038M38F	80 cm	<input type="checkbox"/> CR
A95010012M12F	100 cm	<input type="checkbox"/> CR	A95010012M38F	100 cm	<input type="checkbox"/> CR	A95010038M38F	100 cm	<input type="checkbox"/> CR

DN8



Flessibile in treccia d'acciaio inox Ø12 DN8 per monocomandi con tubo interno in gomma alimentare.
Flexible hose in stainless steel DN8 Ø12 for single-lever mixer, internal in EPDM.

Flessibile in treccia d'acciaio inox Ø12 DN8 per monocomandi con tubo interno in gomma alimentare.
Flexible hose in stainless steel DN8 Ø12 for single-lever mixer, internal in EPDM.

M10x1 - 1/2F o 3/8F

M12x1 - 1/2F o 3/8F

ML10x1 - 1/2F o 3/8F

A9703510M38F	35 cm	<input type="checkbox"/> CR
A9704510M38F	45 cm	<input type="checkbox"/> CR
A9706010M38F	60 cm	<input type="checkbox"/> CR
A9709010M38F	90 cm	<input type="checkbox"/> CR
A9701201038F	120 cm	<input type="checkbox"/> CR
A9701501038F	150 cm	<input type="checkbox"/> CR

A9703512M38F	35 cm	<input type="checkbox"/> CR
A9704512M38F	45 cm	<input type="checkbox"/> CR
A9706012M38F	60 cm	<input type="checkbox"/> CR
A9709012M38F	90 cm	<input type="checkbox"/> CR
A9701201238F	120 cm	<input type="checkbox"/> CR
A9701501238F	150 cm	<input type="checkbox"/> CR

A970L3510M12	35 cm	<input type="checkbox"/> CR
A970L4510M12	45 cm	<input type="checkbox"/> CR
A970L6010M12	60 cm	<input type="checkbox"/> CR
A970L9010M12	90 cm	<input type="checkbox"/> CR
A970L1201012	120 cm	<input type="checkbox"/> CR
A970L1501012	150 cm	<input type="checkbox"/> CR

DN6



Flessibile in treccia d'acciaio inox Ø10 DN6 per monocomandi con tubo interno in gomma alimentare.
Flexible hose in stainless steel DN6 Ø10 for single-lever mixer, internal in EPDM.

M8x1 - 1/2F o 3/8F

M10x1 - 1/2F o 3/8F

A971358M12F	35 cm	<input type="checkbox"/> CR
A971458M12F	45 cm	<input type="checkbox"/> CR
A971608M12F	60 cm	<input type="checkbox"/> CR
A971908M12F	90 cm	<input type="checkbox"/> CR
A9711208M12F	120 cm	<input type="checkbox"/> CR
A9711508M12F	150 cm	<input type="checkbox"/> CR

A9713510M38F	35 cm	<input type="checkbox"/> CR
A9714510M38F	45 cm	<input type="checkbox"/> CR
A9716010M38F	60 cm	<input type="checkbox"/> CR
A9719010M38F	90 cm	<input type="checkbox"/> CR
A97112010M38F	120 cm	<input type="checkbox"/> CR
A97115010M38F	150 cm	<input type="checkbox"/> CR

VOGUE

WIRE

HILTON

REVIVAL

ACCESSORI
ACCESSORIES

SISTEMA WC
WC SYSTEM

SIFONI
TRAPS

PILETTE
DRAIN

RUBINETTI SOTTOLAVABO
ANGLE VALVES

RICAMBI
SPARE PARTS

———— DN13 ————



Flessibile in treccia di acciaio inox gigante Ø 18 per scaldabagno, con tubo interno gomma alimentare EPDM.
Flexible hose in stainless steel Ø 18 for water heater, internal in EPDM.

1/2Fx1/2F

A9902512FF	25 cm	<input type="checkbox"/> CR
A9903012FF	30 cm	<input type="checkbox"/> CR
A9903512FF	35 cm	<input type="checkbox"/> CR
A9904012FF	40 cm	<input type="checkbox"/> CR
A9905012FF	50 cm	<input type="checkbox"/> CR

1/2Fx3/4F

A9902512F34F	25 cm	<input type="checkbox"/> CR
A9903012F34F	30 cm	<input type="checkbox"/> CR
A9903512F34F	35 cm	<input type="checkbox"/> CR
A9904012F34F	40 cm	<input type="checkbox"/> CR
A9905012F34F	50 cm	<input type="checkbox"/> CR

3/4Fx3/4F

A9902534FF	25 cm	<input type="checkbox"/> CR
A9903034FF	30 cm	<input type="checkbox"/> CR
A9903534FF	35 cm	<input type="checkbox"/> CR
A9904034FF	40 cm	<input type="checkbox"/> CR
A9905034FF	50 cm	<input type="checkbox"/> CR

———— DN13 ————



Flessibile in treccia di acciaio inox gigante Ø 18 per scaldabagno, con tubo interno gomma alimentare EPDM.
Flexible hose in stainless steel Ø 18 for water heater, internal in EPDM.

1/2Mx1/2F

A9902512MF	25 cm	<input type="checkbox"/> CR
A9903012MF	30 cm	<input type="checkbox"/> CR
A9903512MF	35 cm	<input type="checkbox"/> CR
A9904012MF	40 cm	<input type="checkbox"/> CR
A9905012MF	50 cm	<input type="checkbox"/> CR

1/2Mx3/4F

A9902512M34F	25 cm	<input type="checkbox"/> CR
A9903012M34F	30 cm	<input type="checkbox"/> CR
A9903512M34F	35 cm	<input type="checkbox"/> CR
A9904012M34F	40 cm	<input type="checkbox"/> CR
A9905012M34F	50 cm	<input type="checkbox"/> CR

3/4Mx1/2F

A9902534M12F	25 cm	<input type="checkbox"/> CR
A9903034M12F	30 cm	<input type="checkbox"/> CR
A9903534M12F	35 cm	<input type="checkbox"/> CR
A9904034M12F	40 cm	<input type="checkbox"/> CR
A9905034M12F	50 cm	<input type="checkbox"/> CR

3/4Mx3/4F

A9902534MF	25 cm	<input type="checkbox"/> CR
A9903034MF	30 cm	<input type="checkbox"/> CR
A9903534MF	35 cm	<input type="checkbox"/> CR
A9904034MF	40 cm	<input type="checkbox"/> CR
A9905034MF	50 cm	<input type="checkbox"/> CR

**RICAMBI
SPARE PARTS**

RUBINETTI SOTTOLAVABO
ANGLE VALVES

PILETTE
DRAIN

SIFONI
TRAPS

SISTEMA WC
WC SYSTEM

ACCESSORI
ACCESSORIES

REVIVAL

HILTON

WIPE

VOGUE

ESPOSITORI

ESPOSITORI DA PAVIMENTO - FLOOR DISPLAYERS



ESPSLIMB



ESPQD



ESPFB

DISPLAYERS

ESPOSITORI DA PARETE - WALL DISPLAYERS



ESPACVERT



ESPAC

ESPOSITORE DA TAVOLO - STANDING DISPLAY



ESPBAS

Basetta da appoggio per singolo rubinetto.
Support base for single faucet.

CONDIZIONI GENERALI DI VENDITA

SALE CONDITIONS

Accettazione ordini: La commissione è sempre subordinata all'approvazione della Casa Venditrice. Le condizioni di vendita si intendono accettate dal committente al momento del conferimento dell'ordine e con il ritiro del materiale.

Consegne e Rese: La merce è resa franco deposito di partenza e viaggio a rischio e pericolo del committente. Il venditore si riserva di poter effettuare consegne parziali.

Spedizioni: Le quantità devono essere verificate all'atto del ricevimento ed eventuali discordanze vanno annotate sulla bolla di consegna mediante accettazione "con riserva". Eventuali spese aggiuntive per giacenze sono a carico del committente.

Imballaggio: L'imballaggio è effettuato con imballi standard ed eventualmente su pallets a carico del committente.

Termini di consegna: I termini di consegna, eventualmente indicati, sono sempre forniti a puro titolo indicativo e non vincolante.

Prezzi: I prezzi riportati nei listini non sono vincolanti. La Daniel Rubinetterie S.p.A. si riserva la facoltà di variare i prezzi di vendita in qualsiasi momento senza nessun preavviso.

Pagamenti: L'eventuale ritardo del pagamento comporterà l'addebito di interessi al tasso corrente. La Daniel Rubinetterie S.p.A. si riserva la facoltà di sospendere eventuali ordini in corso in presenza di pagamenti irregolari. Le contestazioni di qualsiasi valore o entità non danno diritto alla sospensione dei pagamenti.

Reclami: Non si accettano reclami o resi merce dopo 7 giorni dal ricevimento della stessa. I reclami devono pervenire entro i termini indicati tramite lettera raccomandata e via fax. Ogni reso deve essere preventivamente autorizzato dalla Daniel Rubinetterie S.p.A. che fornirà istruzioni in merito.

Caratteristiche tecniche: La Daniel Rubinetterie S.p.A. si riserva la facoltà di apportare ogni variazione agli articoli senza nessun preavviso.

Riservato dominio: I prodotti rimangono di proprietà della Daniel Rubinetterie S.p.A. fino al totale pagamento del prezzo in conformità a quanto previsto dal C.C.

Responsabilità: La Daniel Rubinetterie S.p.A. non fornisce garanzie circa l'impiego errato o inadatto dei propri prodotti. Qualora il materiale risultasse difettoso per vizi di fabbricazione riconosciuti a seguito di perizia, la Daniel Rubinetterie S.p.A. si riserva di sostituirlo o accreditarne il valore senza che la propria responsabilità si possa estendere in nessun caso ad altri oneri.

Foro: Per qualsiasi controversia il Foro competente è quello di Milano.

Orders acceptance: The order is always subject to approval by the seller.

Delivers: The goods are delivered Ex Works and travel at the buyer's own risk. The seller reserves the right to execute partial consignments.

Forwarding: The quantities must be checked on receipt of the goods and any complaint must be made to the carrier. Any additional cost applied by the carrier will be charged to the buyer.

Packing: The goods are packed in standard packing on pallets charged to the customer.

Delivery terms: The delivery terms are always given as information and they never have to be considered as binding.

Prices: The prices shown on price list are not bending. Daniel Rubinetterie S.p.A. reserves the right to modify the sales prices in any time with no prior warning.

Payments: Interest at the current rate will be charged for any delays in payment. Daniel Rubinetterie S.p.A. reserves the right to delete any order on hand if the payments are not correct. Any complaint of whatever type or value do not give the right to suspend payments.

Complaints: Complaints and returned goods cannot be accepted after a period of 7 days from the arrival of the goods. Complaints must be made by mean of a registered letter or by fax within the terms stated. Any return of the goods must be authorized in advance by Daniel Rubinetterie S.p.A. with instructions about it.

Technical specifications: Daniel Rubinetterie S.p.A. reserves the right to carry out technical and aesthetical changes without previous notice.

Lien: The products remain the property of Daniel Rubinetterie S.p.A. until the cost has been paid in full, in accordance with the provisions of the C.C.

Liability: Daniel Rubinetterie S.p.A. does not provide a guarantee covering the incorrect or the inappropriate use of its products. If the material should be substandard owing to manufacturing faults which are technical inspections, Daniel Rubinetterie S.p.A. reserves the right to replace the material or to credit the value to the buyer. However under no circumstance does the company's liability extend to the payment of direct or indirect charges for other things.

Competent Court of Law: For any controversy that may arise the competent court of law is the one of Milan.

2023

DESIGN COLLECTION

DANIEL
RUBINETTERIE
MILANO

DANIEL RUBINETTERIE S.p.A
Via Leonardo da Vinci, 53
20062 Cassano d'Adda
(MI) - Italy
Tel. +39 0363 62 651
Fax +39 0363 62 664
info@daniel.it
www.daniel.it

